



**THE DATASHEET OF  
AP2821KTR-G1**



## General Description

The AP2821 is an integrated high-side power switch that consists of TTL compatible enables input, a charge pump, and N-Channel MOSFET. The switch's low RDS (ON), 120mΩ, meets USB voltage drop requirements. It includes soft-start to limit inrush current, over-current protection with fold-back, and thermal shutdown to avoid switch failure during hot plug-in. Under voltage lockout (UVLO) function is used to ensure the device remain off unless there is a valid input voltage present. And no reverse current when power off, with shutdown pull-low resistor to discharge the output capacitor when EN is disable.

The AP2821 is available in standard package of SOT-23-5.

## Features

- Low MOSFET on Resistance: 120mΩ @  $V_{IN}=5.0V$
- Compliant to USB Specifications
- Operating Voltage Range: 2.7V to 5.5V
- Low Supply Current: 35μA (Typ.)
- Low Shutdown Current: <1μA
- Current Limit with Fold-back: 2A
- Under-voltage Lockout
- Soft Start-up
- Over-current Protection
- Over Temperature Protection
- Load Short Protection with Fold-back
- No Reverse Current when Power off
- Pass System ESD: IEC61000-4-2 ± 16KV (Air Discharge) and ± 8KV (Contact Discharge) on USB Connector

## Applications

- USB Power Management
- USB Bus/Self Powered Hubs
- Hot-plug Power Supplies
- Battery-charger Circuits
- Notebooks, Motherboard PCs

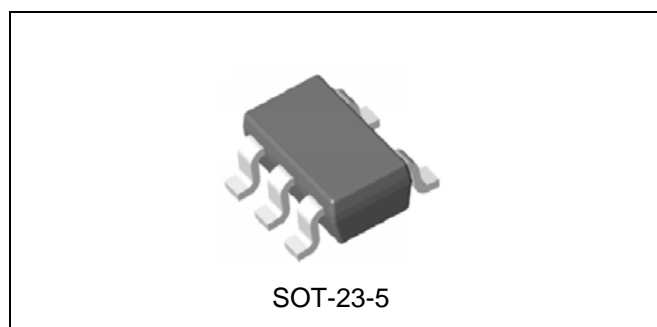

Figure 1. Package Type of AP2821

## Pin Configuration

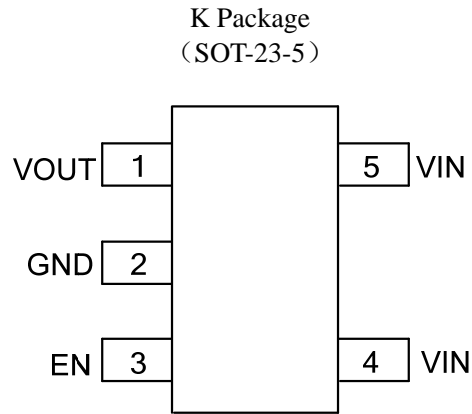

Figure 2. Pin Configuration of AP2821 (Top View)

## Pin Descriptions

| Pin No. | Name | Descriptions                           |
|---------|------|--|
| 1       | VOUT | Switch Output Voltage                  |
| 2       | GND  | Ground                                 |
| 3       | EN   | Chip Enable Control Input, Active High |
| 4, 5    | VIN  | Supply Input Pin                       |

### Functional Block Diagram

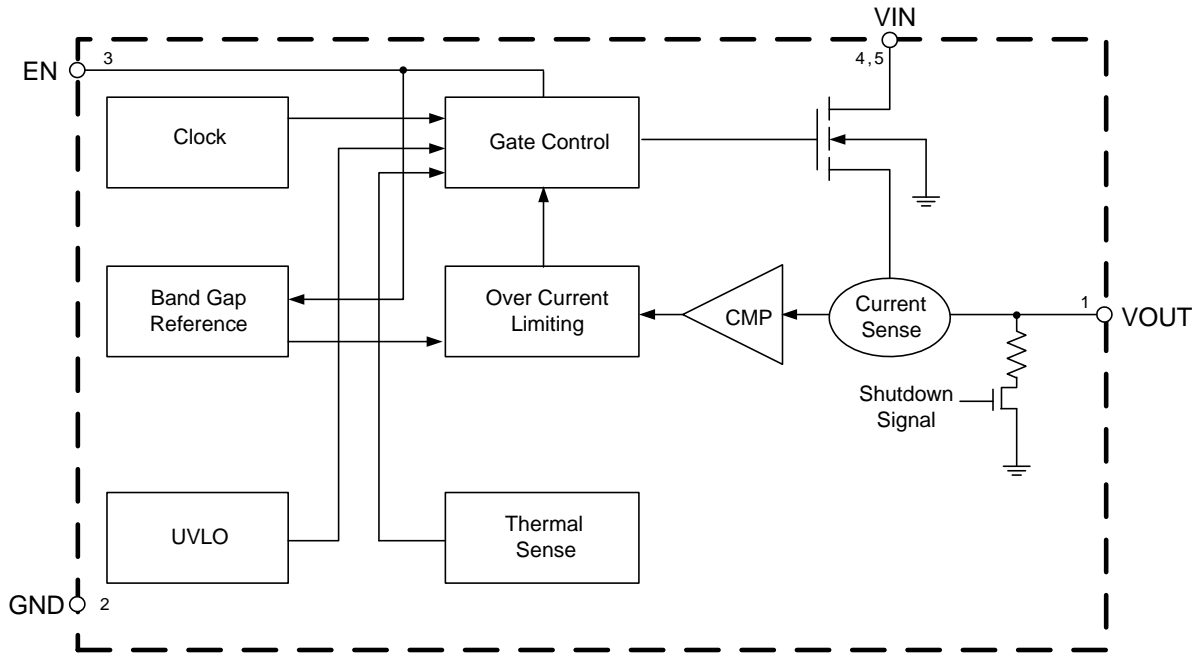

Figure 3. Functional Block Diagram of AP2821



**High-side Power Distribution Switch with Enable**

**AP2821**

**Ordering Information**

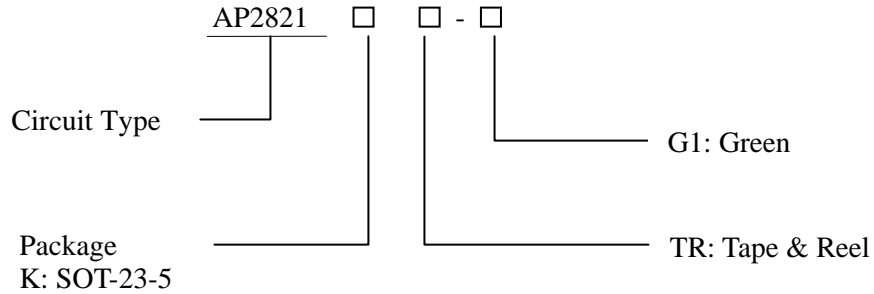

| Package  | Temperature Range | Part Number  | Marking ID | Packing Type |
|----------|-------------------|--------------|------------|--------------|
| SOT-23-5 | -40 to 85°C       | AP2821KTR-G1 | G4E        | Tape & Reel  |

BCD Semiconductor's Pb-free products, as designated with "G1" suffix in the part number, are RoHS compliant and Green.

**High-side Power Distribution Switch with Enable****AP2821****Absolute Maximum Ratings (Note 1)**

| <b>Parameter</b>                         | <b>Symbol</b> | <b>Value</b> | <b>Unit</b> |
|--|---------------|--------------|-------------|
| Power Supply Voltage                     | $V_{IN}$      | 6.0          | V           |
| Operating Junction Temperature Range     | $T_J$         | 150          | °C          |
| Storage Temperature Range                | $T_{STG}$     | -65 to 150   | °C          |
| Lead Temperature (Soldering,10 Seconds)  | $T_{LEAD}$    | 260          | °C          |
| Thermal Resistance (Junction to Ambient) | $\theta_{JA}$ | 235          | °C/W        |
| ESD (Machine Model)                      |               | 200          | V           |
| ESD (Human Body Model)                   |               | 2000         | V           |

Note 1: Stresses greater than those listed under “Absolute Maximum Ratings” may cause permanent damage to the device. These are stress ratings only, and functional operation of the device at these or any other conditions beyond those indicated under “Recommended Operating Conditions” is not implied. Exposure to “Absolute Maximum Ratings” for extended periods may affect device reliability.

**Recommended Operating Conditions**

| <b>Parameter</b>                    | <b>Symbol</b> | <b>Min</b> | <b>Max</b> | <b>Unit</b> |
|-------------------------------------|---------------|------------|------------|-------------|
| Supply Voltage                      | $V_{IN}$      | 2.7        | 5.5        | V           |
| Ambient Operation Temperature Range | $T_A$         | -40        | 85         | °C          |

**High-side Power Distribution Switch with Enable****AP2821****Electrical Characteristics**(V<sub>IN</sub>=5.0V, C<sub>IN</sub>=4.7μF, C<sub>OUT</sub>=4.7μF, Typical T<sub>A</sub>=25°C, unless otherwise specified)

| Parameter                               | Symbol                 | Test Conditions  | Min | Typ | Max | Unit |
|---|------------------------|--|-----|-----|-----|------|
| Input Voltage Range                     | V <sub>IN</sub>        |  | 2.7 |     | 5.5 | V    |
| Switch On Resistance                    | R <sub>DS(ON)</sub>    | V <sub>IN</sub> =5V, I <sub>OUT</sub> =0.5A              |     | 120 | 140 | mΩ   |
| Current Limit                           | I <sub>LIMIT</sub>     | V <sub>OUT</sub> =4.0V                                   | 1.5 | 2.0 | 2.8 | A    |
| Supply Current                          | I <sub>SUPPLY</sub>    | V <sub>IN</sub> =5V, R <sub>LOAD</sub> Open              |     | 35  | 65  | μA   |
| Fold-back Short Current                 | I <sub>SHORT</sub>     | V <sub>OUT</sub> =0V                                     |     | 1.5 |     | A    |
| Shutdown Supply Current                 | I <sub>SHUTDOWN</sub>  | V <sub>EN</sub> =0V, Shutdown Mode                       |     | 0.1 | 1   | μA   |
| Output Leakage Current                  | I <sub>LEAKAGE</sub>   | V <sub>EN</sub> =0V, V <sub>OUT</sub> =0V                |     | 0.1 | 1   | μA   |
| Enable High Voltage                     | V <sub>ENH</sub>       | Enable Logic High  | 2.0 |     | 6.0 | V    |
| Enable Low Voltage                      | V <sub>ENL</sub>       | Enable Logic Low   | 0   |     | 1.2 | V    |
| Enable Pin Input Current                | I <sub>EN</sub>        | Force 0V to 5.0V at EN Pin                               | 0   |     | 1.0 | μA   |
| Under Voltage Lockout Threshold Voltage | V <sub>UVLO</sub>      | V <sub>IN</sub> Increasing from 0V                       | 2.2 | 2.5 | 2.7 | V    |
| Under Voltage Hysteresis                | V <sub>UVLOHY</sub>    |  |     | 0.2 |     | V    |
| Reverse Current                         | I <sub>REVERSE</sub>   | V <sub>EN</sub> =0V, V <sub>OUT</sub> >V <sub>IN</sub>   |     | 0.1 | 1.0 | μA   |
| Shutdown Pull Low Resistance            | R <sub>DISCHARGE</sub> | V <sub>EN</sub> is disable                               |     | 100 | 250 | Ω    |
| Output Turn-on Time                     | t <sub>ON</sub>        | From Enable Active to 90% of Output, R <sub>L</sub> =10Ω |     | 1.9 |     | ms   |
| Thermal Shutdown Temperature            | T <sub>OTS</sub>       |  |     | 145 |     | °C   |
| Thermal Shutdown Hysteresis             | T <sub>HYOTS</sub>     |  |     | 20  |     |      |
| Thermal Resistance (Junction to Case)   | θ <sub>JC</sub>        |  |     | 70  |     | °C/W |

Typical Performance Characteristics

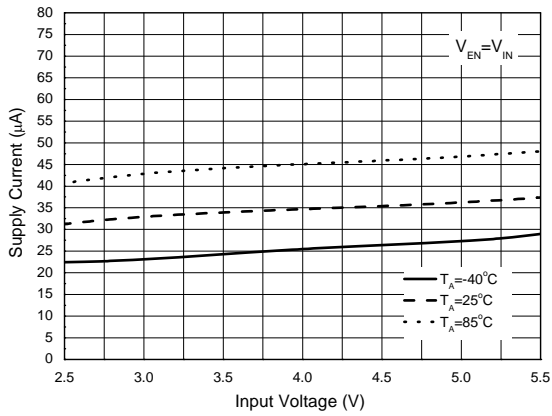

Figure 4. Supply Current vs. Input Voltage

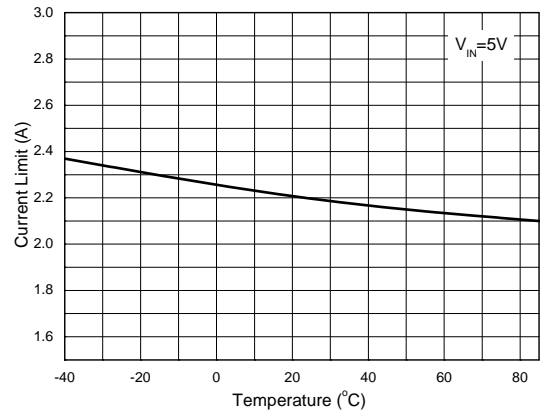

Figure 5. Current Limit vs. Temperature

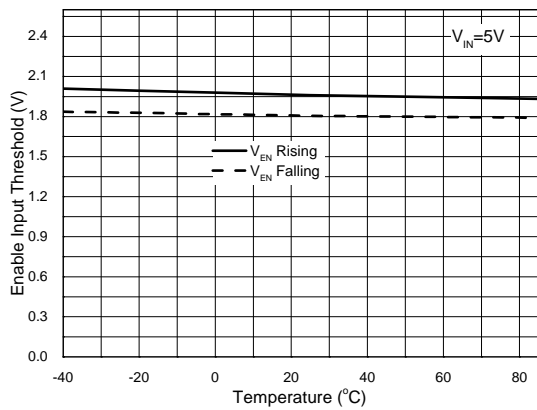

Figure 6. Enable Input Threshold vs. Temperature

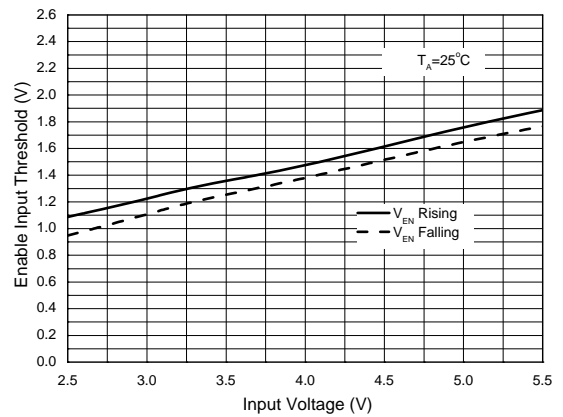

Figure 7. Enable Input Threshold vs. Input Voltage

Typical Performance Characteristics (Continued)

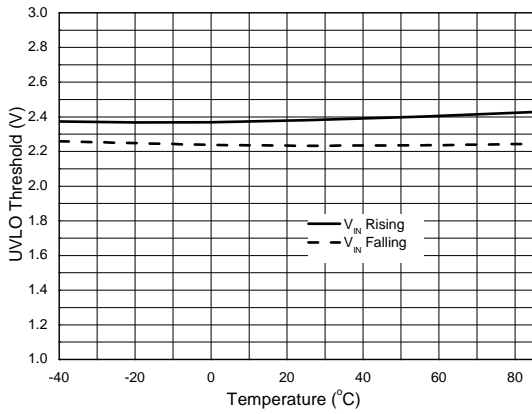

Figure 8. UVLO Threshold Voltage vs. Temperature

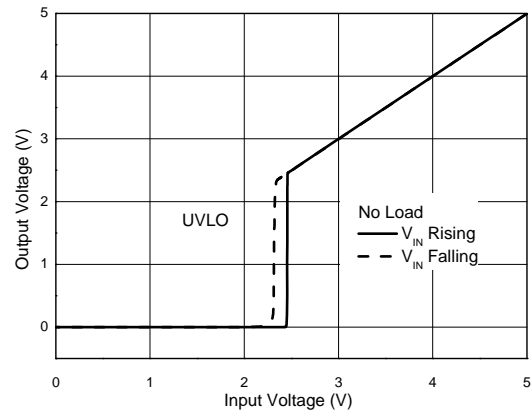

Figure 9. UVLO Function

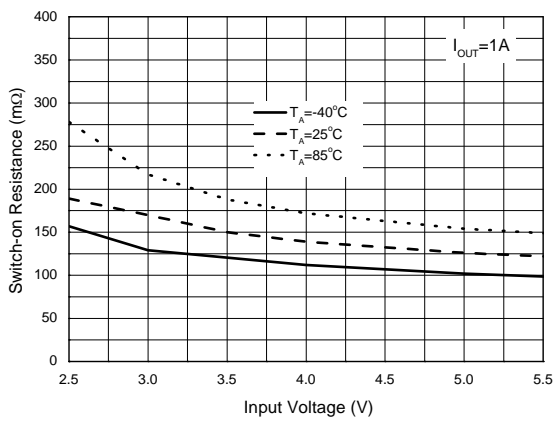

Figure 10. Switch-on Resistance vs. Input Voltage

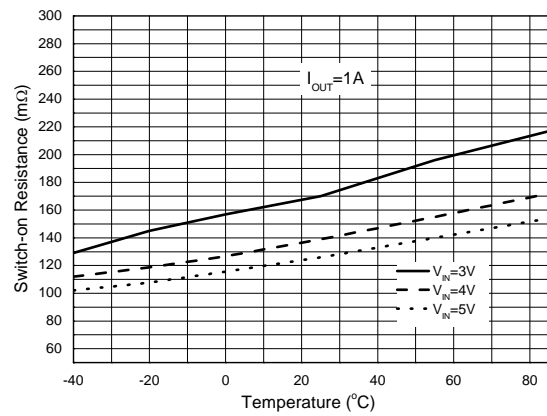

Figure 11. Switch-on Resistance vs. Temperature

Typical Performance Characteristics (Continued)

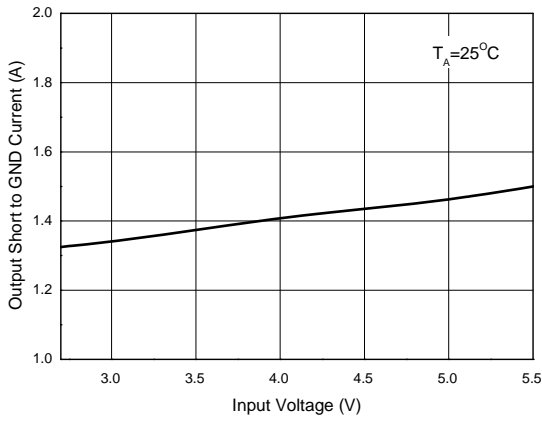

Figure 12. Output Short to GND Current vs. Input Voltage

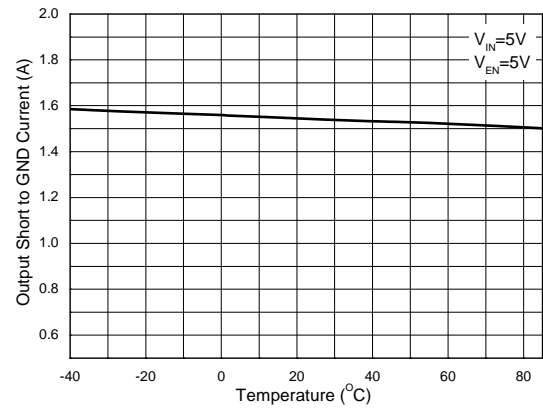

Figure 13. Output Short to GND Current vs. Temperature

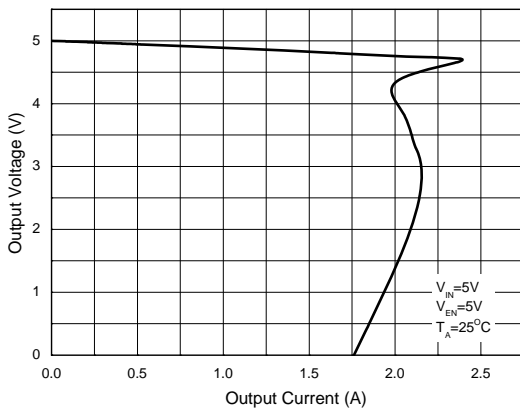

Figure 14. Output Voltage vs. Output Current

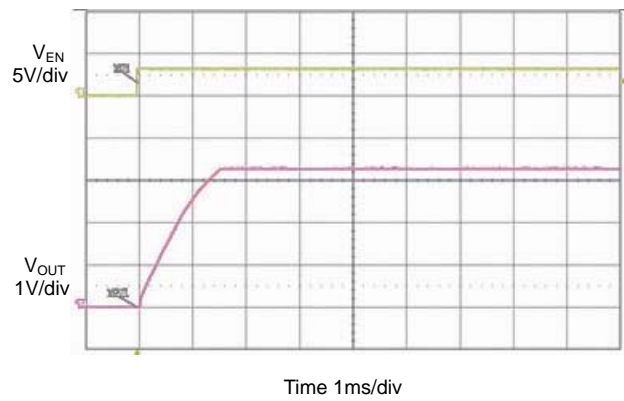

Figure 15. Switch Turn-on and Rise Time (VIN=3.3V, COUT=4.7µF, No Load)

Typical Performance Characteristics (Continued)

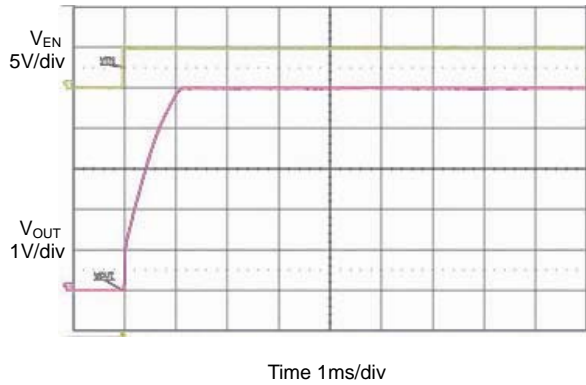

Figure 16. Switch Turn-on and Rise Time  
( $V_{IN}=5.0V$ ,  $C_{OUT}=4.7\mu F$ , No Load)

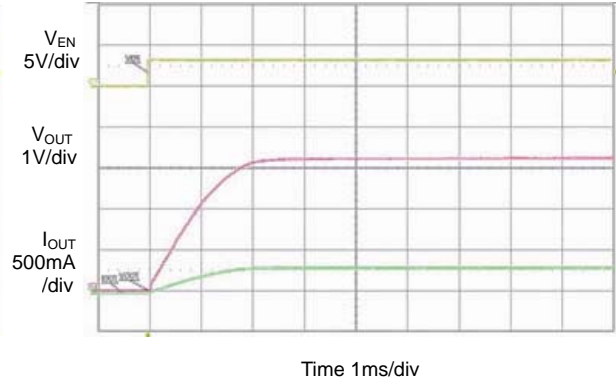

Figure 17. Switch Turn-on and Rise Time  
( $V_{IN}=3.3V$ ,  $C_{OUT}=4.7\mu F$ ,  $R_L=10\Omega$ )

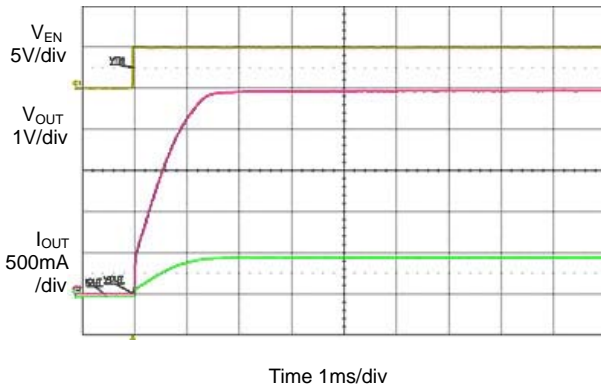

Figure 18. Switch Turn-on and Rise Time  
( $V_{IN}=5.0V$ ,  $C_{OUT}=4.7\mu F$ ,  $R_L=10\Omega$ )

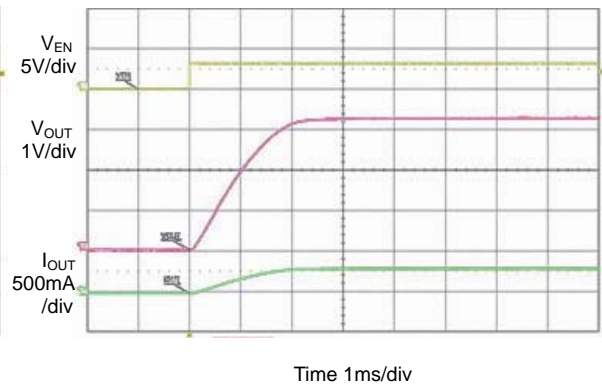

Figure 19. Switch Turn-on and Rise Time  
( $V_{IN}=3.3V$ ,  $C_{OUT}=100\mu F$ ,  $R_L=10\Omega$ )

Typical Performance Characteristics (Continued)

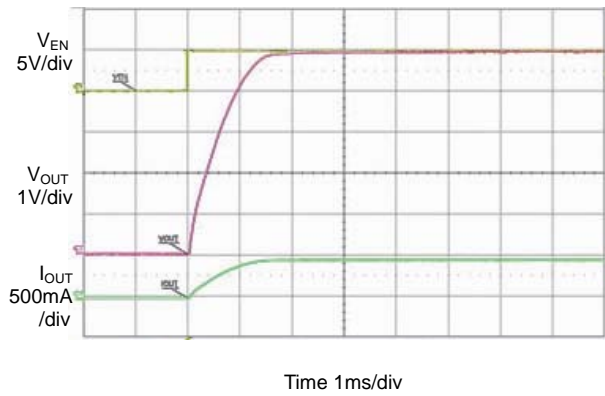

Figure 20. Switch Turn-on and Rise Time  
( $V_{IN}=5.0V$ ,  $C_{OUT}=100\mu F$ ,  $R_L=10\Omega$ )

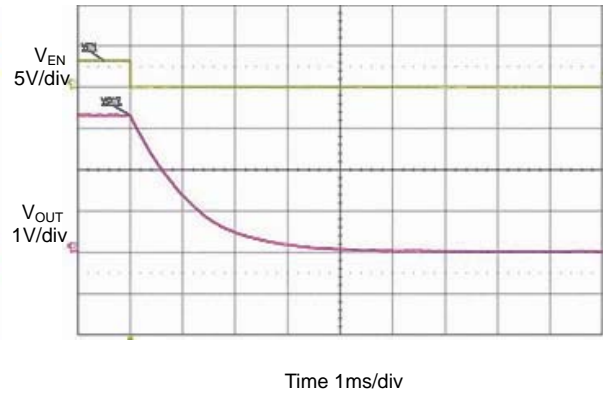

Figure 21. Switch Turn-off and Fall Time  
( $V_{IN}=3.3V$ ,  $C_{OUT}=4.7\mu F$ , No Load)

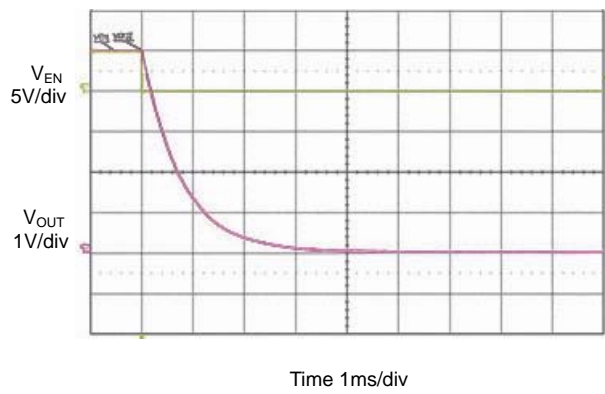

Figure 22. Switch Turn-off and Fall Time  
( $V_{IN}=5.0V$ ,  $C_{OUT}=4.7\mu F$ , No Load)

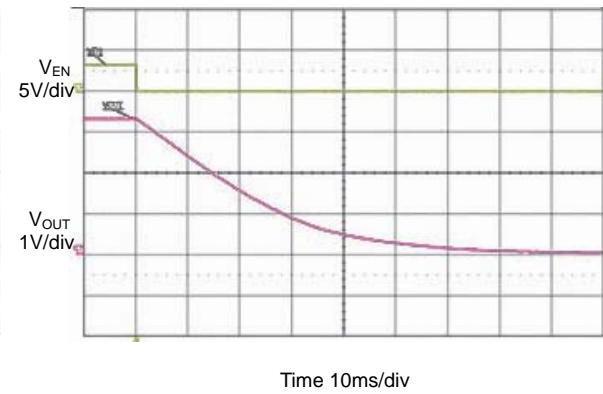

Figure 23. Switch Turn-off and Fall Time  
( $V_{IN}=3.3V$ ,  $C_{OUT}=100\mu F$ , No Load)

Typical Performance Characteristics (Continued)

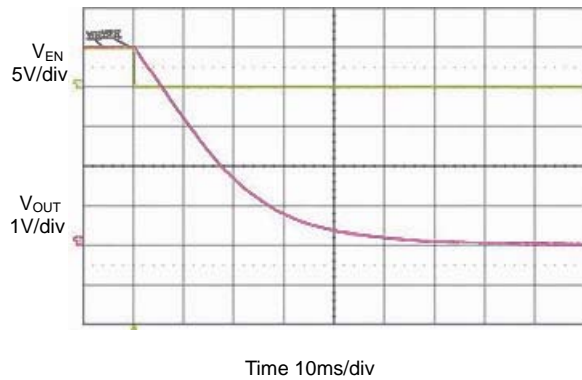

Figure 24. Switch Turn-off and Fall Time  
( $V_{IN}=5.0V$ ,  $C_{OUT}=100\mu F$ , No Load)

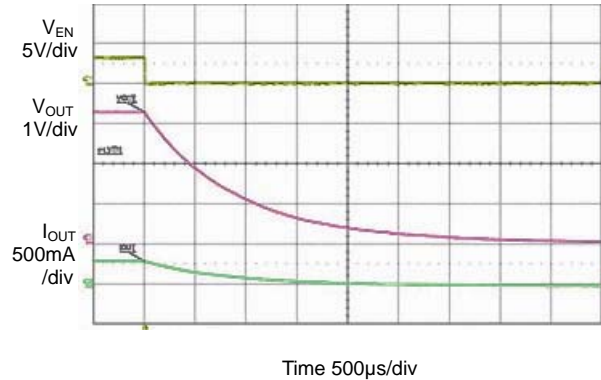

Figure 25. Switch Turn-off and Fall Time  
( $V_{IN}=3.3V$ ,  $C_{OUT}=100\mu F$ ,  $R_L=10\Omega$ )

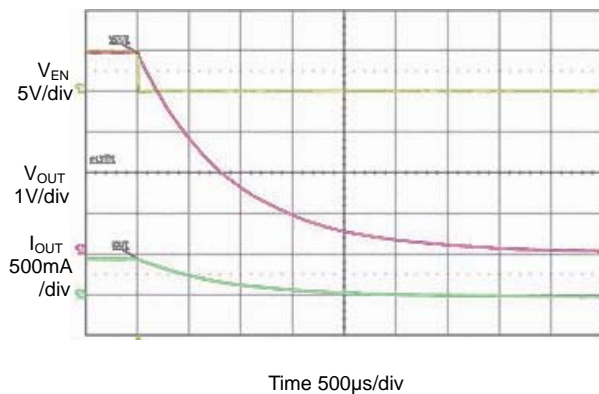

Figure 26. Switch Turn-off and Fall Time  
( $V_{IN}=5.0V$ ,  $C_{OUT}=100\mu F$ ,  $R_L=10\Omega$ )

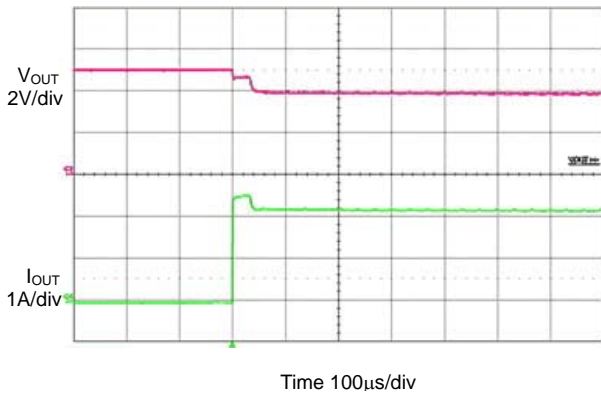

Figure 27. Resistance Load Inrush Response  
( $C_{OUT}=4.7\mu F$ ,  $R_L=1.65\Omega$ )

Typical Performance Characteristics (Continued)

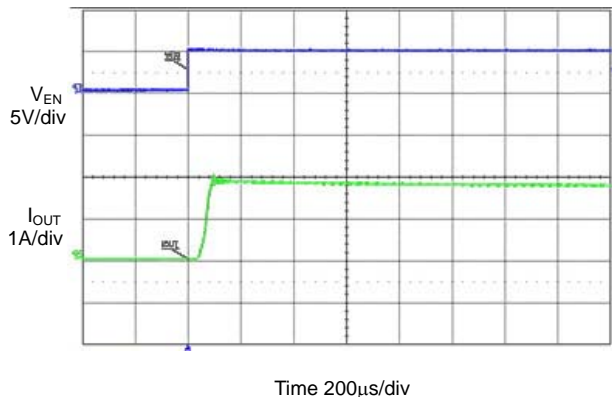

Figure 28. Short-circuit Current, Device Enable into Short ( $V_{IN}=5.0V$ ,  $C_{OUT}=4.7\mu F$ )

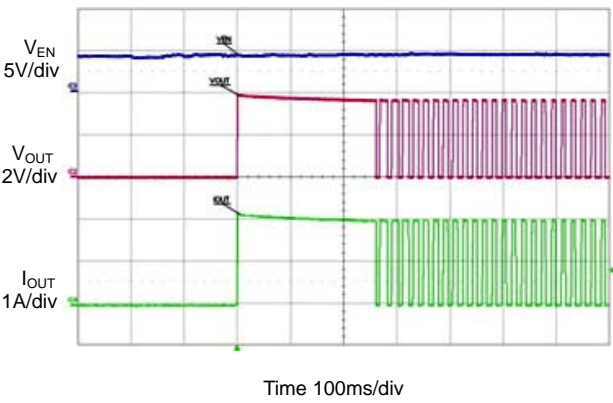
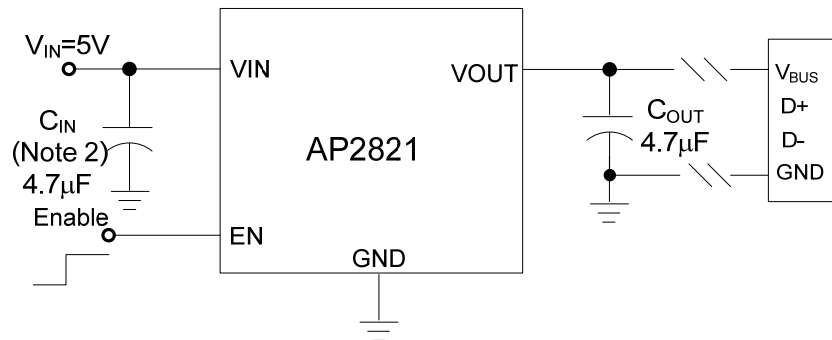

Figure 29. Thermal Shutdown Response ( $V_{IN}=5.0V$ ,  $C_{OUT}=4.7\mu F$ ,  $R_L=1.65\Omega$ )

## Typical Application



Note 2: 4.7µF input capacitor is enough in most application cases.  
 If the PCB trace of power rail to  $V_{IN}$  is long, larger input capacitor is necessary.

Figure 30. AP2821 Typical Application

Mechanical Dimensions

SOT-23-5

Unit: mm(inch)

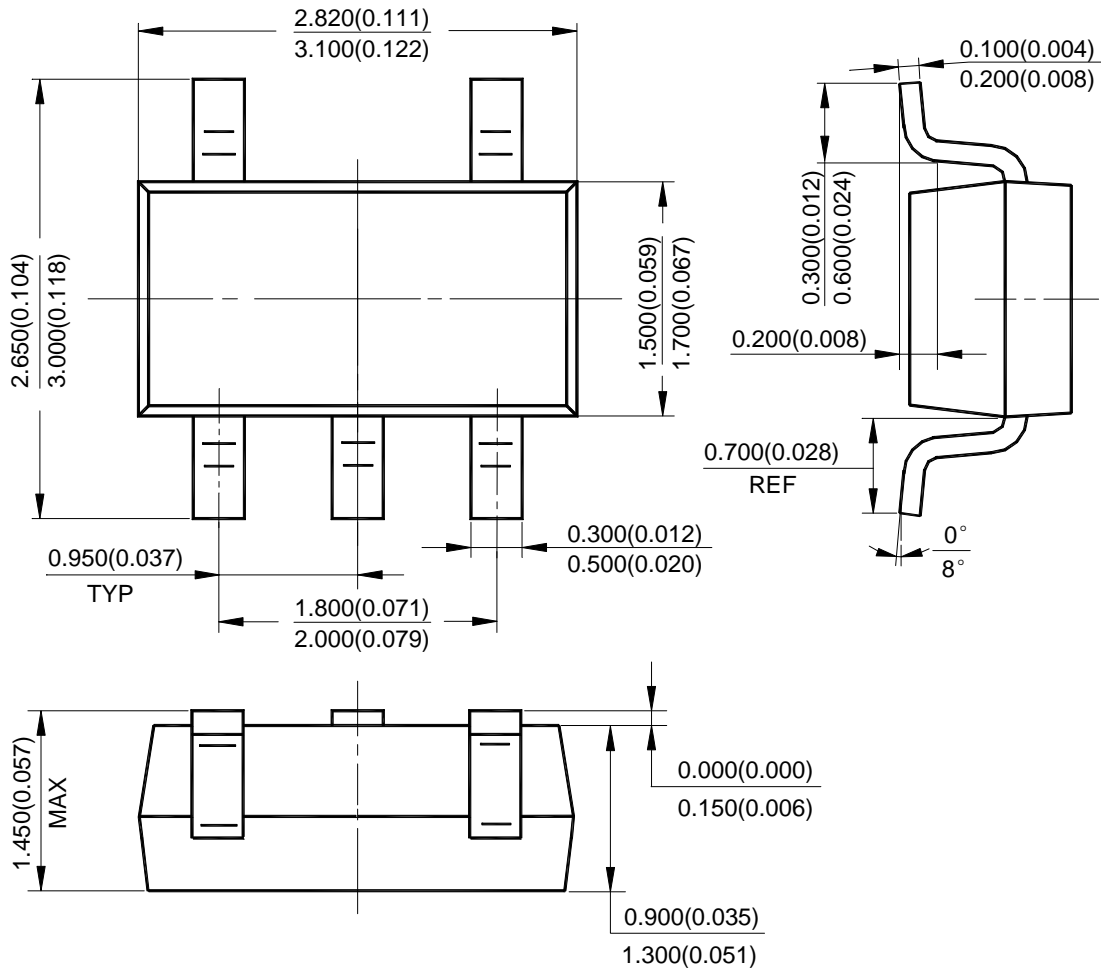

Mounting Pad Layout

SOT-23-5

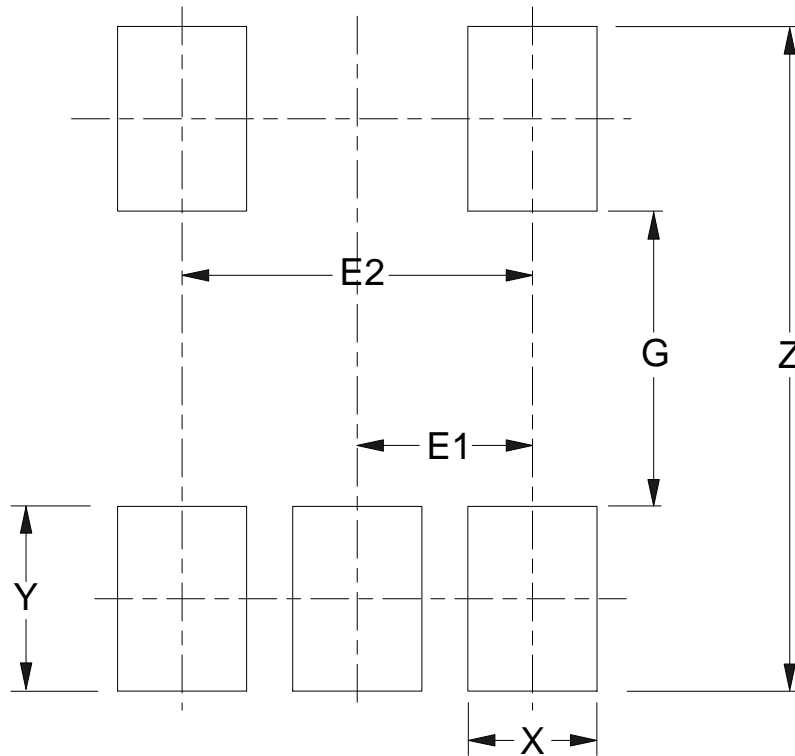

| Dimensions | Z<br>(mm)/(inch) | G<br>(mm)/(inch) | X<br>(mm)/(inch) | Y<br>(mm)/(inch) | E1<br>(mm)/(inch) | E2<br>(mm)/(inch) |
|------------|------------------|------------------|------------------|------------------|-------------------|-------------------|
| Value      | 3.600/0.142      | 1.600/0.063      | 0.700/0.028      | 1.000/0.039      | 0.950/0.037       | 1.900/0.075       |



## BCD Semiconductor Manufacturing Limited

<http://www.bcdsemi.com>

### IMPORTANT NOTICE

BCD Semiconductor Manufacturing Limited reserves the right to make changes without further notice to any products or specifications herein. BCD Semiconductor Manufacturing Limited does not assume any responsibility for use of any its products for any particular purpose, nor does BCD Semiconductor Manufacturing Limited assume any liability arising out of the application or use of any its products or circuits. BCD Semiconductor Manufacturing Limited does not convey any license under its patent rights or other rights nor the rights of others.

---

#### MAIN SITE

##### - Headquarters

##### BCD (Shanghai) Micro-electronics Limited

No. 1600, Zi Xing Road, Shanghai ZiZhu Science-based Industrial Park, 200241, P. R. C.  
Tel: +86-021-2416-2266, Fax: +86-021-2416-2277

##### - Wafer Fab

##### Shanghai SIM-BCD Semiconductor Manufacturing Co., Ltd.

800 Yishan Road, Shanghai 200233, China  
Tel: +021-6485-1491, Fax: +86-021-5450-0008

#### REGIONAL SALES OFFICE

##### Shenzhen Office

##### Shanghai SIM-BCD Semiconductor Manufacturing Co., Ltd., Shenzhen Office

Unit A Room 1203, Skyworth Bldg., Gaoxin Ave.1.S., Nanshan District  
Shenzhen 518057, China

Tel: +86-0755-8660-4900, Fax: +86-0755-8660-4958

##### Taiwan Office (Taipei)

##### BCD Semiconductor (Taiwan) Company Limited

3F, No.17, Lane 171, Sec. 2, Jiu-Zong Rd., Nei-Hu Dist., Taipei(114), Taiwan, R.O.C  
Tel: +886-2-2656-2808

Fax: +886-2-2656-2806/26562950

##### Taiwan Office (Hsinchu)

##### BCD Semiconductor (Taiwan) Company Limited

8F, No.176, Sec. 2, Gong-Dao 5th Road, East District  
HsinChu City 300, Taiwan, R.O.C

Tel: +886-3-5160181, Fax: +886-3-5160181

##### USA Office

##### BCD Semiconductor Corp.

48460 Kato Road, Fremont, CA 94538, USA  
Tel: +1-510-668-1950

Fax: +1-510-668-1990

##### Korea Office

##### BCD Semiconductor Limited Korea office.

Room 101-1112, Digital-Empire II, 486 Sin-dong,  
Yeongtong-Gu, Suwon-city, Gyeonggi-do, Korea

Tel: +82-31-695-8430

## Looking for pricing, stock, or lifecycle information?

Click below to explore more details on WIN SOURCE:

-  [View AP2821KTR-G1 on WIN SOURCE](#)
-  [Diodes Incorporated](#) Information

## Optimize Your Supply Chain with WIN SOURCE Solutions

-  Global Sourcing Solution
-  Obsolete Management
-  Cost Control Management
-  Shortage Management
-  Alternative Solution
-  Excess Inventory Management