



THE DATASHEET OF AP2820CMMTR-G1



High-side Power Distribution Switch with Enable and Flag

AP2820

General Description

The AP2820 is an integrated high-side power switch that consists of N-Channel MOSFET, charge pump, over current & temperature and other related protection circuits. The switch's low $R_{DS(ON)}$, 60m Ω , is designed to meet USB voltage drop requirements. The IC includes soft-start to limit inrush current, over-current protection, load short protection with fold-back, and thermal shutdown to avoid switch failure during hot plug-in. Under voltage lockout (UVLO) function is used to ensure the device remain off unless there is a valid input voltage present. A FLAG output is available to indicate fault conditions to the local USB controller.

The AP2820 is available in standard packages of SOIC-8 and MSOP-8.

Applications

- USB Power Management
- USB Bus/Self Powered Hubs
- Hot-plug Power Supplies
- Battery-charger Circuits
- Notebooks, Motherboard PCs

Features

- Low MOSFET on Resistance: 60m Ω
- Compliant to USB Specifications
- Available 2 Versions of Load Ability:
 - Guarantee 2.0A Continuous Load for A/B/C/D Version
 - Guarantee 2.5A Continuous Load for E/F/G/H Version
- Logic Level Enable Pin: Available with Active-high or Active-low Version
- Operating Voltage Range: 2.7V to 5.5V
- Low Supply Current:
 - 75 μ A (Typ.) (For A/B/C/D versions)
 - 80 μ A (Typ.) (For E/F/G/H versions)
- Low Shutdown Current: 1.0 μ A (Max)
- Under-voltage Lockout
- Soft Start-up
- Over-current Protection
- Over Temperature Protection
- Load Short Protection with Fold-back
- No Reverse Current When Power Off
- Deglitched FLAG Output with Open Drain
- With Output Shutdown Pull-low Resistor for A/C/E/G Versions
- UL Approved (File No. E339337)
- Nemko CB Scheme IEC60950-1, Ref. Certif No. NO62093

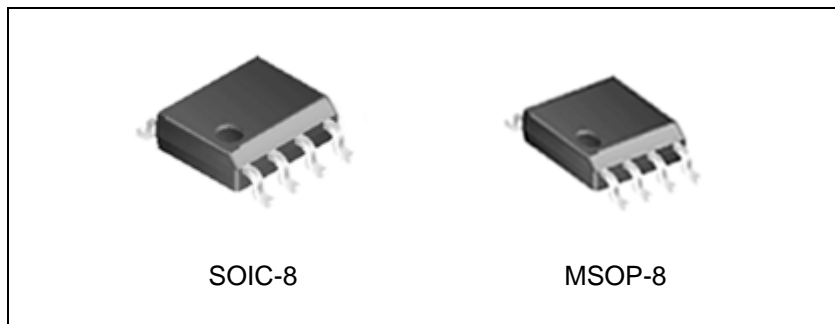

Figure 1. Package Types of AP2820

Pin Configuration

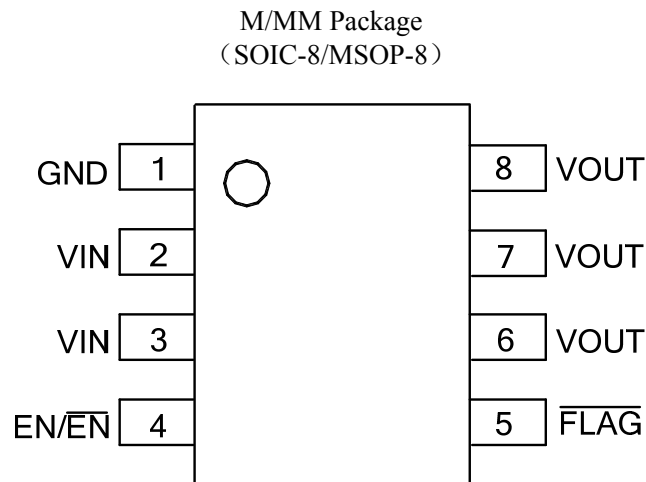

Figure 2. Pin Configuration of AP2820 (Top View)

Pin Descriptions

Pin Number	Pin Name	Function
1	GND	Ground
2, 3	VIN	Supply input pin
4	EN/ $\overline{\text{EN}}$	Chip enable control input, active low or high
5	$\overline{\text{FLAG}}$	Fault flag pin, output with open drain, need a pull-up resistor in application, active low to indicate OCP or OTP
6, 7, 8	VOUT	Switch output voltage

Functional Block Diagram

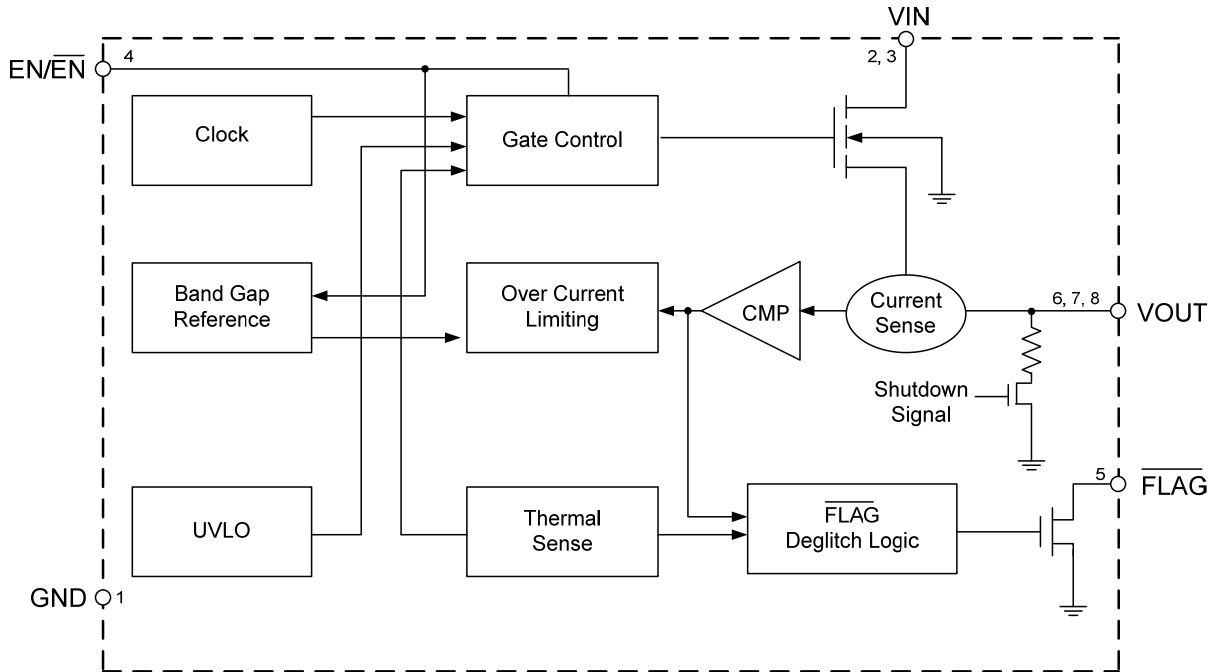
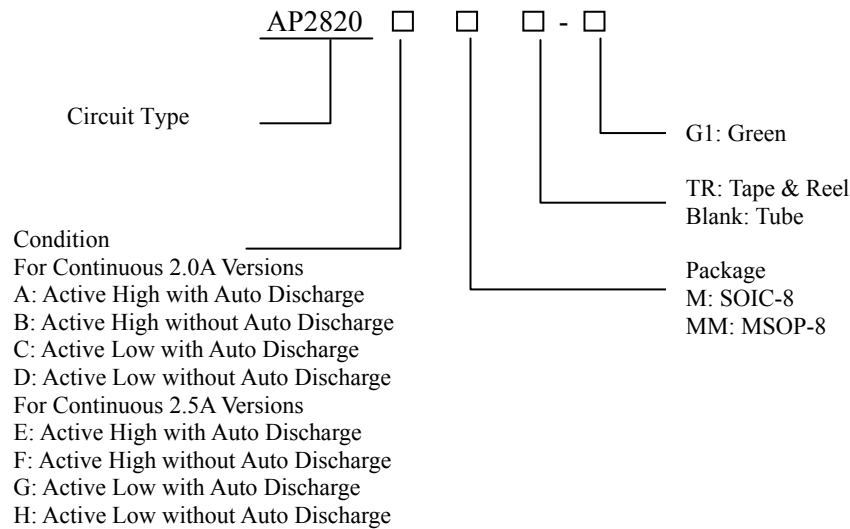

Figure 3. Functional Block Diagram of AP2820



High-side Power Distribution Switch with Enable and Flag AP2820

Ordering Information



Package	Temperature Range	Condition	Part Number	Marking ID	Packing Type
SOIC-8	-40 to 85°C	Active High with Auto Discharge (Continuous 2.0A)	AP2820AM-G1	2820AM-G1	Tube
			AP2820AMTR-G1	2820AM-G1	Tape & Reel
		Active High without Auto Discharge (Continuous 2.0A)	AP2820BM-G1	2820BM-G1	Tube
			AP2820BMTR-G1	2820BM-G1	Tape & Reel
	-40 to 85°C	Active Low with Auto Discharge (Continuous 2.0A)	AP2820CM-G1	2820CM-G1	Tube
			AP2820CMTR-G1	2820CM-G1	Tape & Reel
		Active Low without Auto Discharge (Continuous 2.0A)	AP2820DM-G1	2820DM-G1	Tube
			AP2820DMTR-G1	2820DM-G1	Tape & Reel
	-40 to 85°C	Active High with Auto Discharge (Continuous 2.5A)	AP2820EM-G1	2820EM-G1	Tube
			AP2820EMTR-G1	2820EM-G1	Tape & Reel
		Active High without Auto Discharge (Continuous 2.5A)	AP2820FM-G1	2820FM-G1	Tube
			AP2820FMTR-G1	2820FM-G1	Tape & Reel
-40 to 85°C	Active Low with Auto Discharge (Continuous 2.5A)	AP2820GM-G1	2820GM-G1	Tube	
		AP2820GMTR-G1	2820GM-G1	Tape & Reel	
	Active Low without Auto Discharge (Continuous 2.5A)	AP2820HM-G1	2820HM-G1	Tube	
		AP2820HMTR-G1	2820HM-G1	Tape & Reel	

**High-side Power Distribution Switch with Enable and Flag****AP2820****Ordering Information (Continued)**

Package	Temperature Range	Condition	Part Number	Marking ID	Packing Type
MSOP-8	-40 to 85°C	Active High with Auto Discharge (Continuous 2.0A)	AP2820AMM-G1	2820AMM-G1	Tube
			AP2820AMMTR-G1	2820AMM-G1	Tape & Reel
		Active High without Auto Discharge (Continuous 2.0A)	AP2820BMM-G1	2820BMM-G1	Tube
			AP2820BMMTR-G1	2820BMM-G1	Tape & Reel
	-40 to 85°C	Active Low with Auto Discharge (Continuous 2.0A)	AP2820CMM-G1	2820CMM-G1	Tube
			AP2820CMMTR-G1	2820CMM-G1	Tape & Reel
		Active Low without Auto Discharge (Continuous 2.0A)	AP2820DMM-G1	2820DMM-G1	Tube
			AP2820DMMTR-G1	2820DMM-G1	Tape & Reel
	-40 to 85°C	Active High with Auto Discharge (Continuous 2.5A)	AP2820EMM-G1	2820EMM-G1	Tube
			AP2820EMMTR-G1	2820EMM-G1	Tape & Reel
		Active High without Auto Discharge (Continuous 2.5A)	AP2820FMM-G1	2820FMM-G1	Tube
			AP2820FMMTR-G1	2820FMM-G1	Tape & Reel
	-40 to 85°C	Active Low with Auto Discharge (Continuous 2.5A)	AP2820GMM-G1	2820GMM-G1	Tube
			AP2820GMMTR-G1	2820GMM-G1	Tape & Reel
Active Low without Auto Discharge (Continuous 2.5A)		AP2820HMM-G1	2820HMM-G1	Tube	
		AP2820HMMTR-G1	2820HMM-G1	Tape & Reel	

BCD Semiconductor's Pb-free products, as designated with "G1" suffix in the part number, are RoHS compliant and green.

**High-side Power Distribution Switch with Enable and Flag****AP2820****Absolute Maximum Ratings (Note 1)**

Parameter	Symbol	Value	Unit	
Power Supply Voltage	V_{IN}	6.0	V	
Operating Junction Temperature Range	T_J	150	°C	
Storage Temperature Range	T_{STG}	-65 to 150	°C	
Lead Temperature (Soldering, 10sec)	T_{LEAD}	260	°C	
Thermal Resistance Junction to Ambient	θ_{JA}	SOIC-8	135	°C/W
		MSOP-8	150	
CDM (Charge Device Model)		1000	V	
ESD (Human Body Model)		2000	V	

Note 1: Stresses greater than those listed under “Absolute Maximum Ratings” may cause permanent damage to the device. These are stress ratings only, and functional operation of the device at these or any other conditions beyond those indicated under “Recommended Operating Conditions” is not implied. Exposure to “Absolute Maximum Ratings” for extended periods may affect device reliability.

Recommended Operating Conditions

Parameter	Symbol	Min	Max	Unit
Supply Voltage	V_{IN}	2.7	5.5	V
Operating Ambient Temperature Range	T_A	-40	85	°C

**High-side Power Distribution Switch with Enable and Flag****AP2820****Electrical Characteristics****For A/B/C/D Versions**

($V_{IN}=5.0V$, $C_{IN}=2.2\mu F$, $C_{OUT}=1.0\mu F$, Typical $T_A=25^\circ C$, **Bold** typeface applies over $-40^\circ C \leq T_A \leq 85^\circ C$ ranges, unless otherwise specified)

Parameter	Symbol	Condition	Min	Typ	Max	Unit
Input Voltage Range	V_{IN}		2.7		5.5	V
Switch On Resistance	$R_{DS(ON)}$	$V_{IN}=5V$, $I_{OUT}=2.0A$		60	80	m Ω
Current Limit	I_{LIMIT}	$V_{OUT}=4.0V$	2.2	2.7	3.2	A
Supply Current	I_{SUPPLY}	$V_{IN}=5V$, No Load		75	105	μA
Fold-back Short Current	I_{SHORT}	$V_{OUT}=0$		1.18		A
Shutdown Supply Current	$I_{SHUTDOWN}$	Chip Disable, Shutdown Mode		0.1	1	μA
Enable High Input Threshold	V_{ENH}		1.6		5.5	V
Enable Low Input Threshold	V_{ENL}		0		1.0	V
Enable Pin Input Current	I_{EN}	Force 0V to 5V at EN Pin	-1.0		1.0	μA
Under Voltage Lockout Threshold Voltage	V_{UVLO}	V_{IN} Increasing from 0V	2.2	2.5	2.7	V
Under Voltage Hysteresis	V_{UVLOHY}			0.2		V
Reverse Current	$I_{REVERSE}$	Chip Disable, $V_{OUT} > V_{IN}$		0.1	1.0	μA
Output Pull Low Resistance after Shutdown	$R_{DISCHARGE}$	AP2820A, AP2820C Only		100	200	Ω
Output Turn-on Time	t_{ON}	From Enable Active to 90% of Output		500		μs
FLAG Pin Delay Time	t_{DFLG}	From Over Current Fault Condition to Flag Active	5	10	15	ms
FLAG Pin Low Voltage	V_{FLG}	$I_{SINK}=5mA$		35	70	mV
FLAG Pin Leakage Current	$I_{LEAKAGE}$	FLAG Disable, Force 5.0V			1.0	μA
Thermal Shutdown Temperature	T_{OTS}			150		$^\circ C$
Thermal Shutdown Hysteresis	T_{HYOTS}			30		$^\circ C$



High-side Power Distribution Switch with Enable and Flag AP2820

Electrical Characteristics (Continued)

For E/F/G/H Versions

($V_{IN}=5.0V$, $C_{IN}=2.2\mu F$, $C_{OUT}=1.0\mu F$, Typical $T_A=25^\circ C$, **Bold** typeface applies over $-40^\circ C \leq T_A \leq 85^\circ C$ ranges, unless otherwise specified)

Parameter	Symbol	Condition	Min	Typ	Max	Unit
Input Voltage Range	V_{IN}		2.7		5.5	V
Switch On Resistance	$R_{DS(ON)}$	$V_{IN}=5V$, $I_{OUT}=2.5A$		60	80	m Ω
Current Limit	I_{LIMIT}	$V_{OUT}=4.0V$	2.8	3.4	4.2	A
Supply Current	I_{SUPPLY}	$V_{IN}=5V$, No Load		80	110	μA
Fold-back Short Current	I_{SHORT}	$V_{OUT}=0$		1.18		A
Shutdown Supply Current	$I_{SHUTDOWN}$	Chip Disable, Shutdown Mode		0.1	1	μA
Enable High Input Threshold	V_{ENH}		1.6		5.5	V
Enable Low Input Threshold	V_{ENL}		0		1.0	V
Enable Pin Input Current	I_{EN}	Force 0V to 5V at EN Pin	-1.0		1.0	μA
Under Voltage Lockout Threshold Voltage	V_{UVLO}	V_{IN} Increasing from 0V	2.2	2.5	2.7	V
Under Voltage Hysteresis	V_{UVLOHY}			0.2		V
Reverse Current	$I_{REVERSE}$	Chip Disable, $V_{OUT} > V_{IN}$		0.1	1.0	μA
Output Pull Low Resistance after Shutdown	$R_{DISCHARGE}$	AP2820E, AP2820G Only		100	200	Ω
Output Turn-on Time	t_{ON}	From Enable Active to 90% of Output		500		μs
FLAG Pin Delay Time	t_{DFLG}	From Over Current Fault Condition to Flag Active	5	10	15	ms
FLAG Pin Low Voltage	V_{FLG}	$I_{SINK}=5mA$		35	70	mV
FLAG Pin Leakage Current	$I_{LEAKAGE}$	FLAG Disable, Force 5.0V			1.0	μA
Thermal Shutdown Temperature	T_{OTSD}			150		$^\circ C$
Thermal Shutdown Hysteresis	T_{HYOTSD}			30		$^\circ C$

High-side Power Distribution Switch with Enable and Flag AP2820

Typical Performance Characteristics

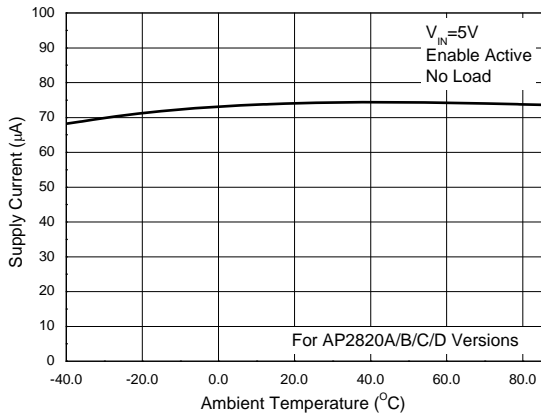

Figure 4. Supply Current vs. Ambient Temperature

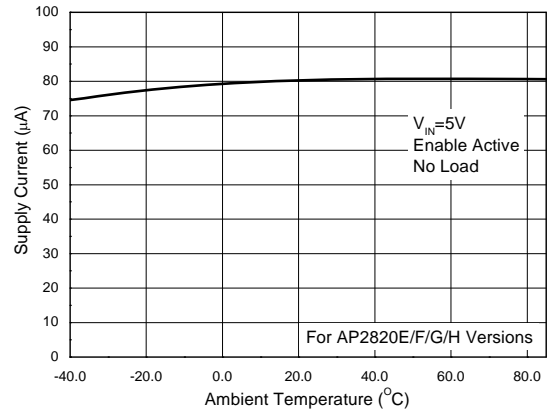

Figure 5. Supply Current vs. Ambient Temperature

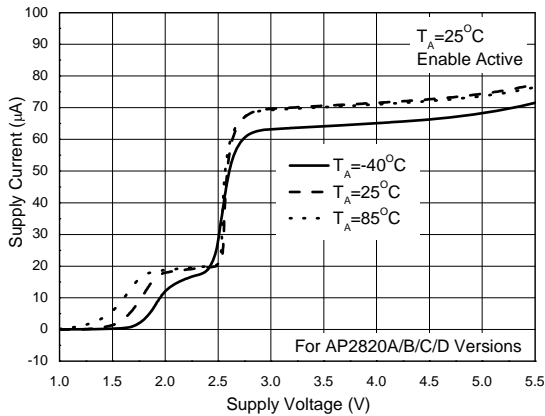

Figure 6. Supply Current vs. Supply Voltage

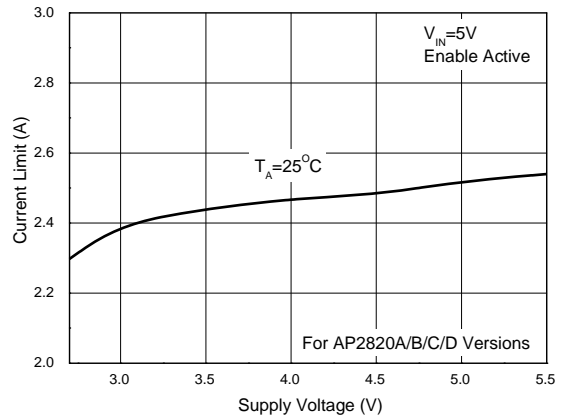

Figure 7. Current Limit vs. Supply Voltage

High-side Power Distribution Switch with Enable and Flag AP2820

Typical Performance Characteristics (Continued)

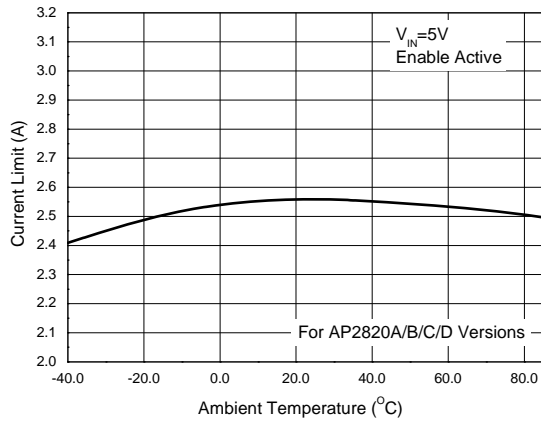

Figure 8. Current Limit vs. Ambient Temperature

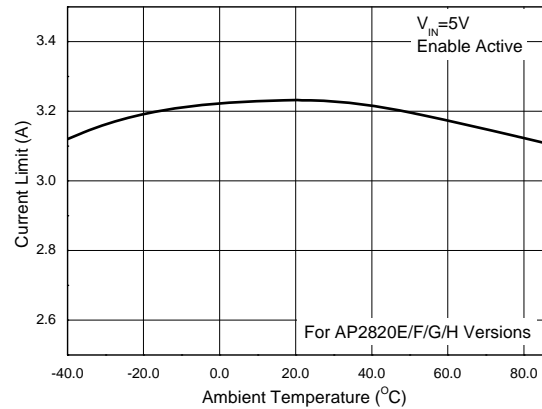

Figure 9. Current Limit vs. Ambient Temperature

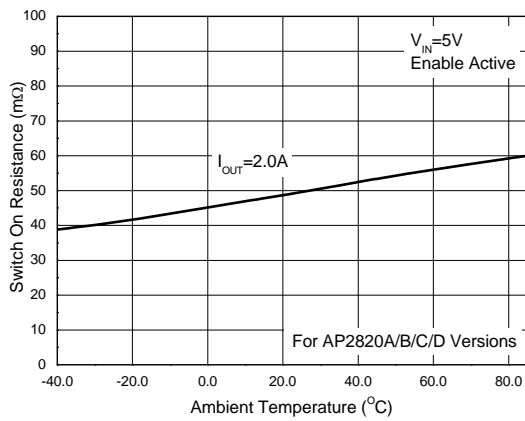

Figure 10. Switch On Resistance vs. Ambient Temperature

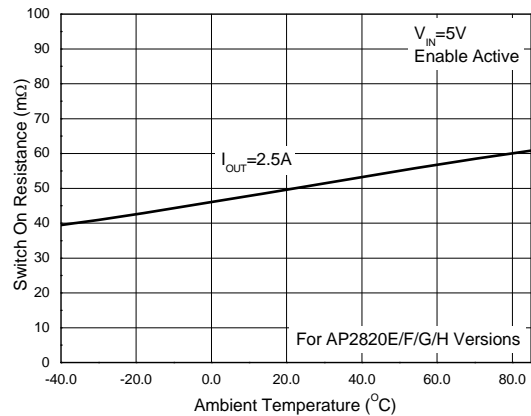

Figure 11. Switch On Resistance vs. Ambient Temperature

High-side Power Distribution Switch with Enable and Flag AP2820

Typical Performance Characteristics (Continued)

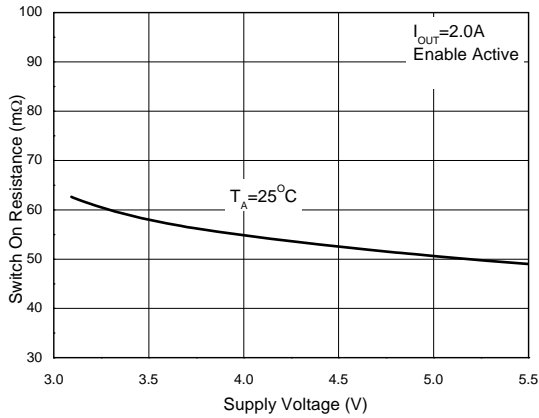

Figure 12. Switch On Resistance vs. Supply Voltage

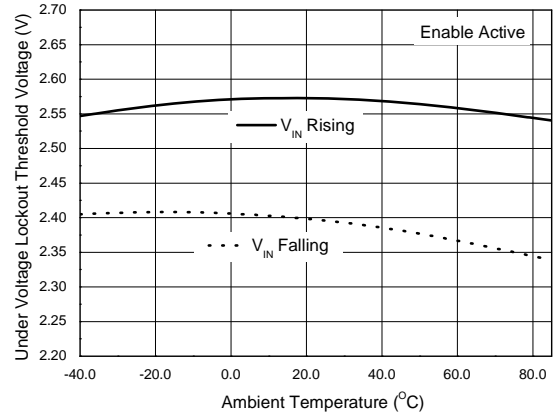

Figure 13. UVLO Voltage vs. Ambient Temperature

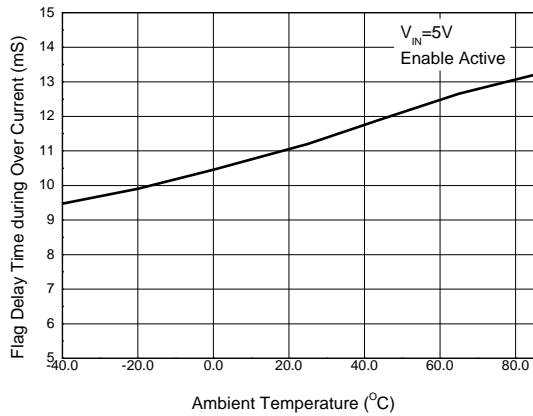

Figure 14. Flag Delay Time during Over Current vs. Ambient Temperature

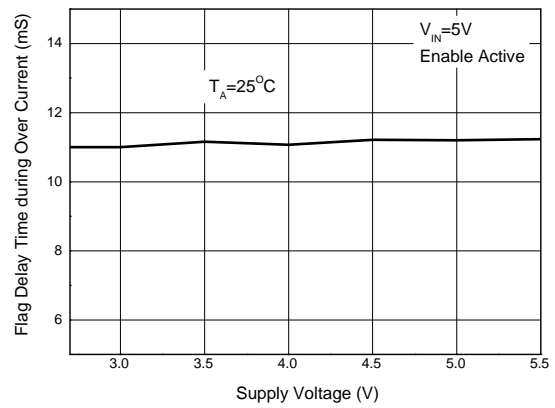

Figure 15. Flag Delay Time during Over Current vs. Supply Voltage

High-side Power Distribution Switch with Enable and Flag AP2820

Typical Performance Characteristics (Continued)

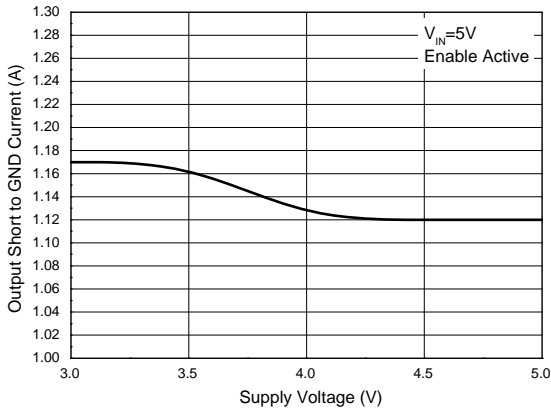

Figure 16. Output Short to GND Current vs. Supply Voltage

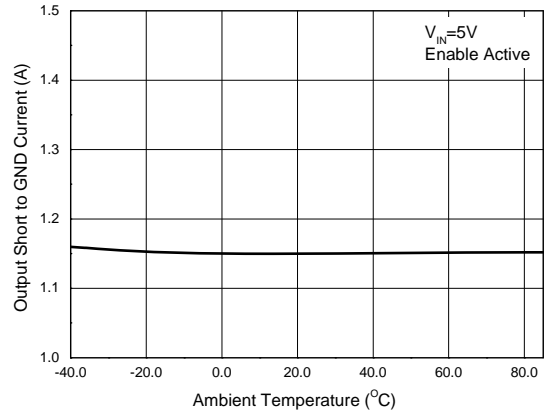

Figure 17. Output Short to GND Current vs. Ambient Temperature

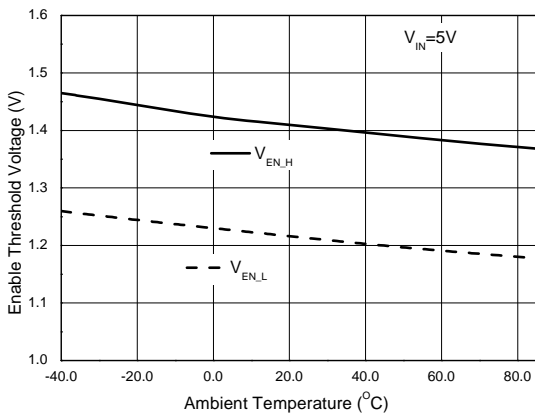

Figure 18. Enable Threshold Voltage vs. Ambient Temperature

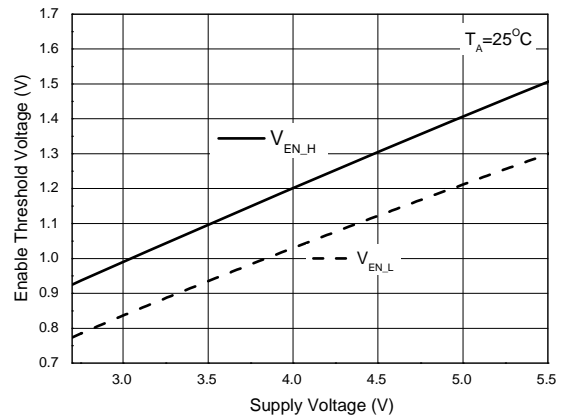

Figure 19. Enable Threshold Voltage vs. Supply Voltage

Typical Performance Characteristics (Continued)



Time 500µs/div

Figure 20. Output Turn On and Rise Time
($C_{IN}=1.0\mu F$, $C_{OUT}=1.0\mu F$, No Load)



Time 500µs/div

Figure 21. Output Turn On and Rise Time
($C_{IN}=1.0\mu F$, $C_{OUT}=1.0\mu F$, $R_L=3.3\Omega$)



Time 500µs/div

Figure 22. Output Turn On and Rise Time
($C_{IN}=1.0\mu F$, $C_{OUT}=220\mu F$, No Load)

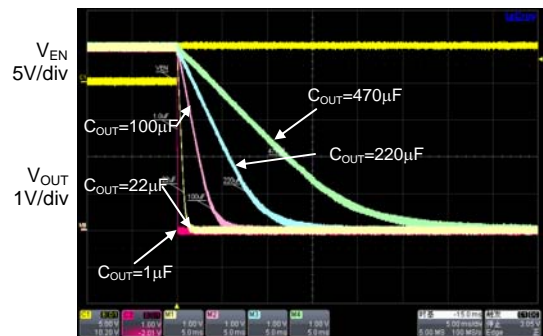

Time 5ms/div

Figure 23. Output Turn Off and Fall Time
($V_{IN}=5V$, $C_{IN}=1.0\mu F$, No Load)

Typical Performance Characteristics (Continued)

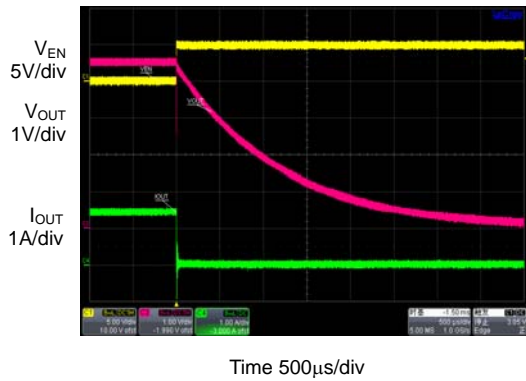

Figure 24. Output Turn Off and Fall Time ($V_{IN}=5V$, $C_{IN}=1.0\mu F$, $C_{OUT}=470\mu F$, $R_L=3.3\Omega$)

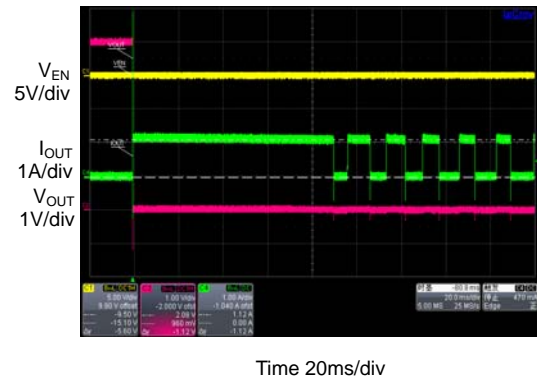

Figure 25. Output Short to GND Current ($V_{IN}=5V$, $C_{IN}=1.0\mu F$)

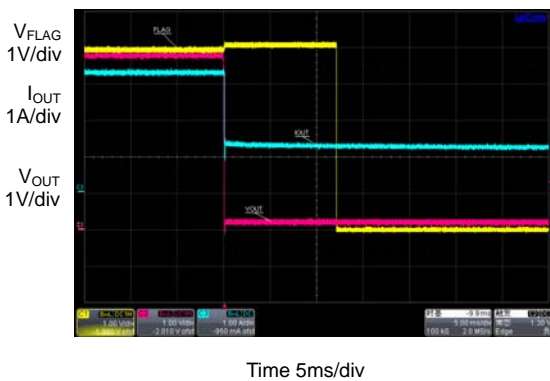

Figure 26. FLAG Response during Over Current

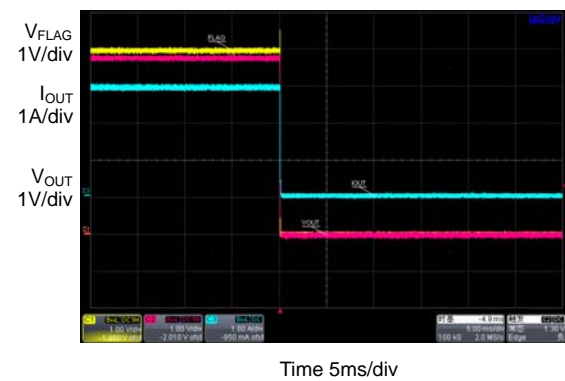
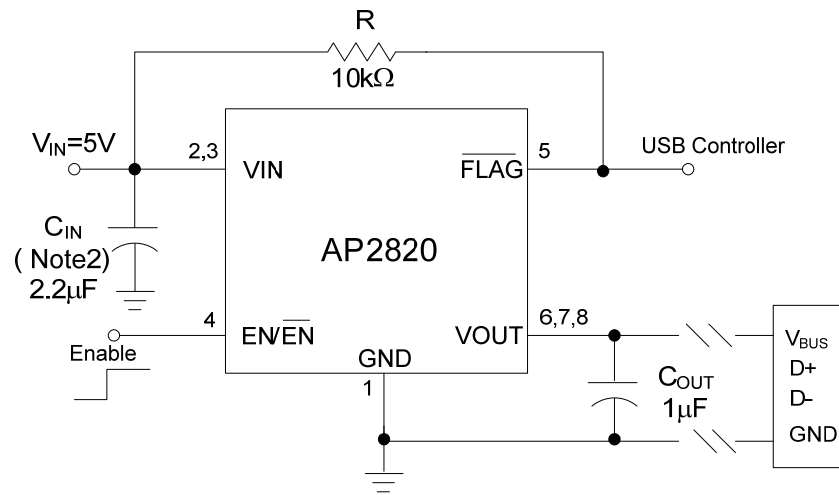

Figure 27. FLAG Response during Over Temperature ($T_A=125^\circ C$)

Typical Application

Note 2: 2.2μF input capacitor is enough in most application cases.

If the VOUT is short to ground frequently during usage, large size input capacitor is necessary, recommend 22μF.

Figure 28. Typical Application of AP2820

High-side Power Distribution Switch with Enable and Flag AP2820

Mechanical Dimensions

SOIC-8

Unit: mm(inch)

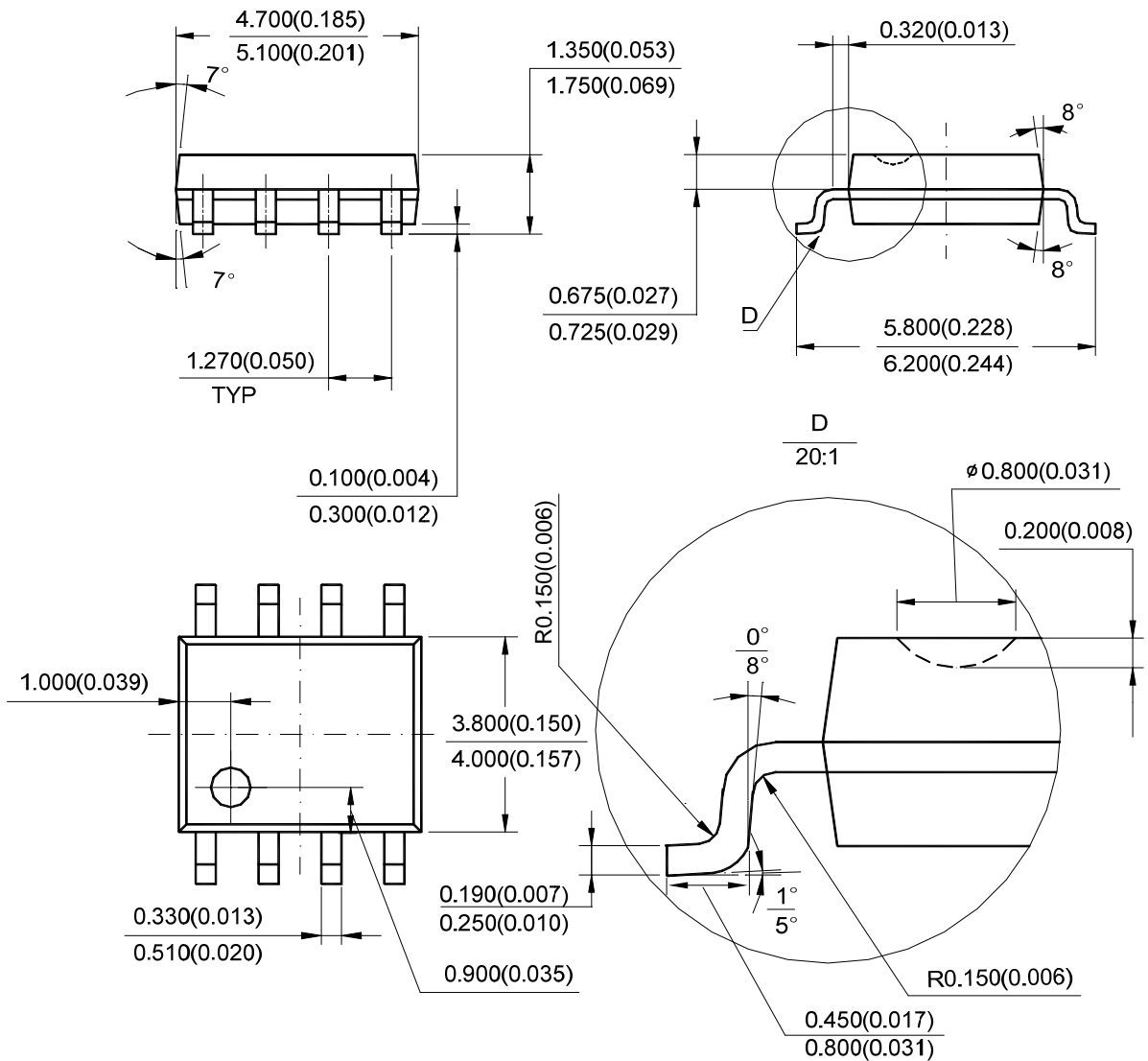

Note: Eject hole, oriented hole and mold mark is optional.

High-side Power Distribution Switch with Enable and Flag AP2820

Mechanical Dimensions (Continued)

MSOP-8

Unit: mm(inch)

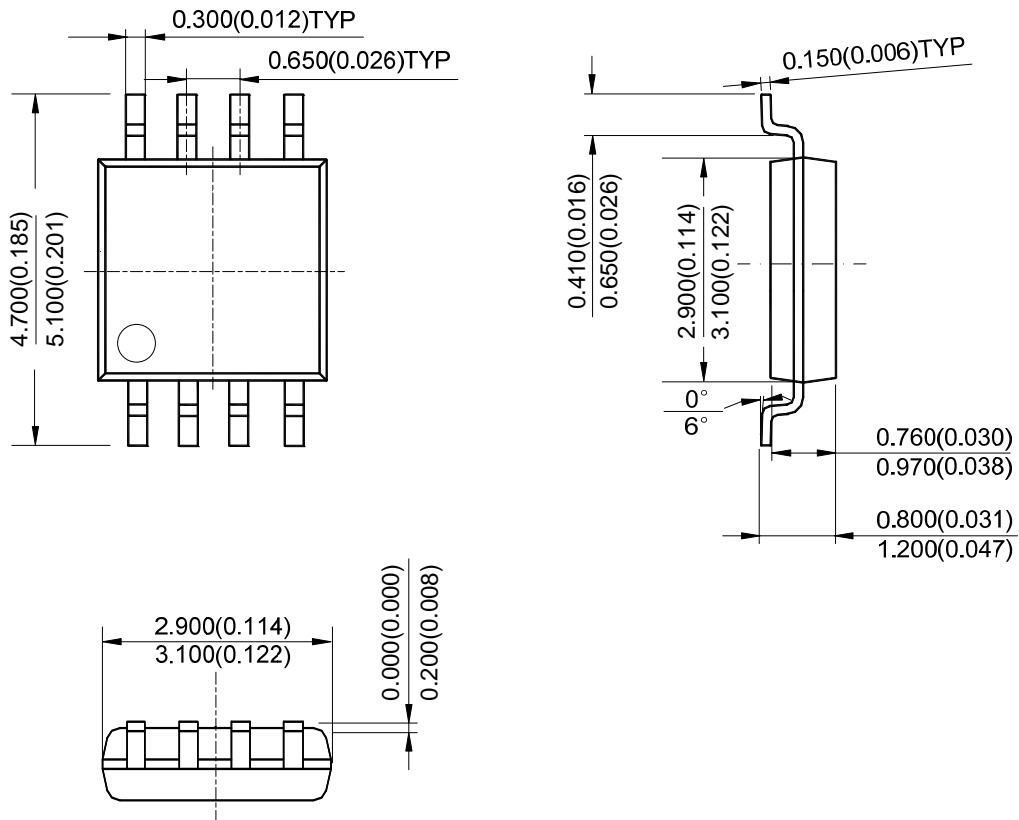

Note: Eject hole, oriented hole and mold mark is optional.



BCD Semiconductor Manufacturing Limited

<http://www.bcdsemi.com>

IMPORTANT NOTICE

BCD Semiconductor Manufacturing Limited reserves the right to make changes without further notice to any products or specifications herein. BCD Semiconductor Manufacturing Limited does not assume any responsibility for use of any its products for any particular purpose, nor does BCD Semiconductor Manufacturing Limited assume any liability arising out of the application or use of any its products or circuits. BCD Semiconductor Manufacturing Limited does not convey any license under its patent rights or other rights nor the rights of others.

MAIN SITE

- Headquarters

BCD Semiconductor Manufacturing Limited

No. 1600, Zi Xing Road, Shanghai Zizhu Science-based Industrial Park, 200241, China
Tel: +86-21-24162266, Fax: +86-21-24162277

- Wafer Fab

Shanghai SIM-BCD Semiconductor Manufacturing Co., Ltd.

800 Yi Shan Road, Shanghai 200233, China
Tel: +86-21-6485 1491, Fax: +86-21-5450 0008

REGIONAL SALES OFFICE

Shenzhen Office

Shanghai SIM-BCD Semiconductor Manufacturing Co., Ltd., Shenzhen Office

Unit A Room 1203, Skyworth Bldg., Gaoxin Ave. 1.S., Nanshan District, Shenzhen, China
Tel: +86-755-8826 7951
Fax: +86-755-8826 7865

Taiwan Office

BCD Semiconductor (Taiwan) Company Limited

4F, 298-1, Rui Guang Road, Nei-Hu District, Taipei, Taiwan
Tel: +886-2-2656 2808
Fax: +886-2-2656 2806

USA Office

BCD Semiconductor Corp.

30920 Huntwood Ave. Hayward, CA 94544, USA
Tel : +1-510-324-2988
Fax: +1-510-324-2788

Looking for pricing, stock, or lifecycle information?

Click below to explore more details on WIN SOURCE:

-  [View AP2820CMMTR-G1 on WIN SOURCE](#)
-  [Diodes Incorporated Information](#)

Optimize Your Supply Chain with WIN SOURCE Solutions

-  Global Sourcing Solution
-  Obsolete Management
-  Cost Control Management
-  Shortage Management
-  Alternative Solution
-  Excess Inventory Management