



THE DATASHEET OF AP2805AMMTR-G1



General Description

The AP2805 is an integrated high-side power switch that consists of N-Channel MOSFET, charge pump, over current & temperature and other related protection circuits. The switch's low RDS (ON), 60mΩ, design easily to meet USB voltage drop requirements. It includes soft-start to limit inrush current, over-current protection, load short protection with fold-back, and thermal shutdown to avoid switch failure during hot plug-in. Under voltage lockout (UVLO) function is used to ensure the device remain off unless there is a valid input voltage present. A Flag output is available to indicate fault conditions to the local USB controller.

The AP2805 is available in standard packages of SOIC-8 and MSOP-8.

Features

- Low MOSFET on Resistance: 60mΩ@V_{IN}=5.0V
- Compliant to USB Specifications
- Operating Voltage Range: 2.7V to 5.5V
- Low Supply Current: 60μA (Typ.)
- Low Shutdown Current: 1.0μA (Max)
- Guarantee 0.5A Continuous Load
- Current Limit: 0.7A (Min), 1.4A (Max)
- Under-voltage Lockout
- Logic Level Enable Pin: Available in Active-high or Active-low Version
- Over-current Protection
- Over Temperature Protection
- Load Short Protection with Fold-back
- No Reverse Current When Power Off
- Deglitched Flag Output with Open Drain
- With Output Shutdown Pull-low Resistor for A/C Versions
- UL Approved (File No. E339337)
- Nemko CB Scheme IEC60950-1, Ref. Certif No. NO67288

Applications

- USB Power Management
- USB Bus/Self Powered Hubs
- Hot-plug Power Supplies
- Battery-charger Circuits
- Notebooks, Motherboard PCs

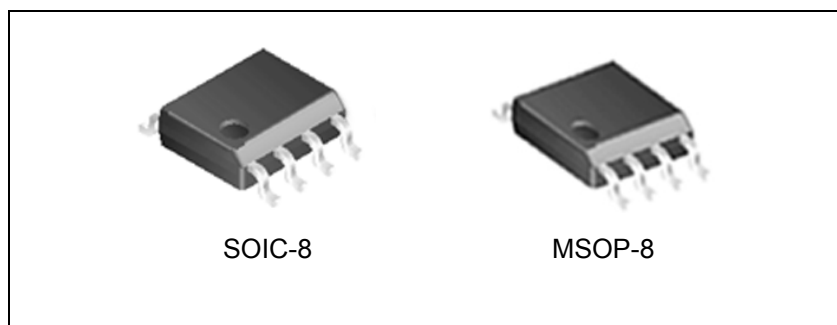

Figure 1. Package Types of AP2805

Pin Configuration

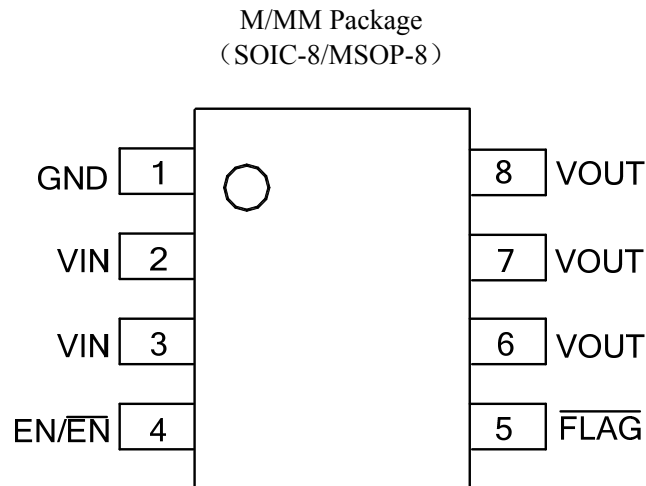

Figure 2. Pin Configuration of AP2805 (Top View)

Pin Descriptions

Pin Number	Pin Name	Function
1	GND	Ground
2, 3	VIN	Supply input pin
4	EN/ $\overline{\text{EN}}$	Chip enable control input, active low or high
5	$\overline{\text{FLAG}}$	Fault flag pin, output with open drain, need a pull-up resistor in application, active low to indicate OCP or OTP
6, 7, 8	VOUT	Switch output voltage

Functional Block Diagram

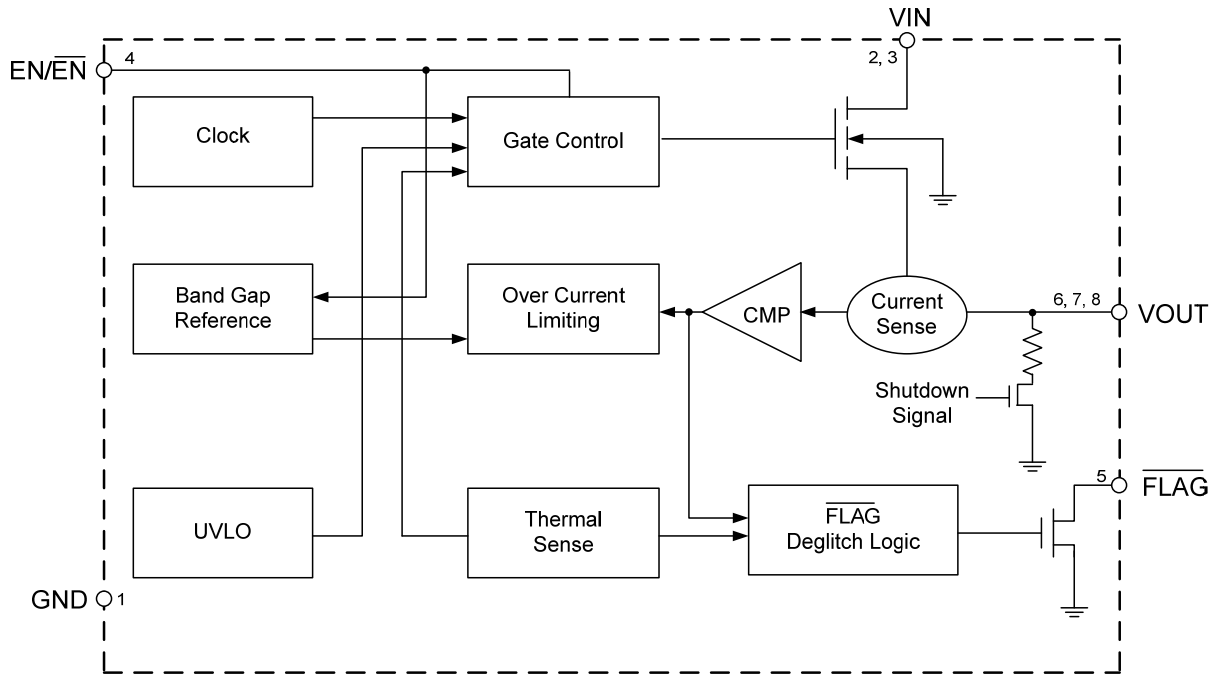
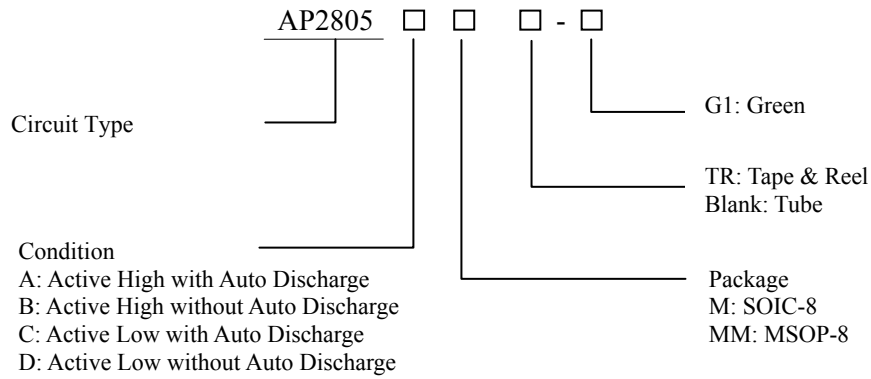

Figure 3. Functional Block Diagram of AP2805

500mA High-side Power Distribution Switch with Enable and Flag

AP2805

Ordering Information



Product	Package	Condition	Temperature Range	Part Number	Marking ID	Packing Type
				Green	Green	
AP2805A	SOIC-8	Active High with Auto Discharge	-40 to 85°C	AP2805AM-G1	2805AM-G1	Tube
				AP2805AMTR-G1	2805AM-G1	Tape & Reel
	MSOP-8			AP2805AMM-G1	2805AMM-G1	Tube
				AP2805AMMTR-G1	2805AMM-G1	Tape & Reel
AP2805B	SOIC-8	Active High without Auto Discharge	-40 to 85°C	AP2805BM-G1	2805BM-G1	Tube
				AP2805BMTR-G1	2805BM-G1	Tape & Reel
	MSOP-8			AP2805BMM-G1	2805BMM-G1	Tube
				AP2805BMMTR-G1	2805BMM-G1	Tape & Reel
AP2805C	SOIC-8	Active Low with Auto Discharge	-40 to 85°C	AP2805CM-G1	2805CM-G1	Tube
				AP2805CMTR-G1	2805CM-G1	Tape & Reel
	MSOP-8			AP2805CMM-G1	2805CMM-G1	Tube
				AP2805CMMTR-G1	2805CMM-G1	Tape & Reel
AP2805D	SOIC-8	Active Low without Auto Discharge	-40 to 85°C	AP2805DM-G1	2805DM-G1	Tube
				AP2805DMTR-G1	2805DM-G1	Tape & Reel
	MSOP-8			AP2805DMM-G1	2805DMM-G1	Tube
				AP2805DMMTR-G1	2805DMM-G1	Tape & Reel

BCD Semiconductor's Pb-free products, as designated with "G1" suffix in the part number, are RoHS compliant and Green.

**500mA High-side Power Distribution Switch with Enable and Flag****AP2805****Absolute Maximum Ratings (Note 1)**

Parameter	Symbol	Value	Unit	
Power Supply Voltage	V_{IN}	6.0	V	
Operating Junction Temperature Range	T_J	150	°C	
Storage Temperature Range	T_{STG}	-65 to 150	°C	
Lead Temperature (Soldering, 10 sec)	T_{LEAD}	260	°C	
Thermal Resistance (Junction to Ambient)	θ_{JA}	SOIC-8	135	°C/W
		MSOP-8	150	
ESD (Machine Model)		200	V	
ESD (Human Body Model)		2000	V	

Note 1: Stresses greater than those listed under “Absolute Maximum Ratings” may cause permanent damage to the device. These are stress ratings only, and functional operation of the device at these or any other conditions beyond those indicated under “Recommended Operating Conditions” is not implied. Exposure to “Absolute Maximum Ratings” for extended periods may affect device reliability.

Recommended Operating Conditions

Parameter	Symbol	Min	Max	Unit
Supply Voltage	V_{IN}	2.7	5.5	V
Operating Ambient Temperature Range	T_A	-40	85	°C

**500mA High-side Power Distribution Switch with Enable and Flag****AP2805****Electrical Characteristics**(V_{IN}=5.0V, C_{IN}=2.2μF, C_{OUT}=1.0μF, Typical T_A=25°C, unless otherwise specified)

Parameter	Symbol	Conditions	Min	Typ	Max	Unit
Input Voltage Range	V _{IN}		2.7		5.5	V
Switch On Resistance	R _{DS(ON)}	V _{IN} =5.0V, I _{OUT} =0.5A		60	80	mΩ
Current Limit	I _{LIMIT}	V _{OUT} =4.0V	0.7	1.0	1.4	A
Supply Current	I _{SUPPLY}	V _{IN} =5.0V, No Load		60	80	μA
Fold-back Short Current	I _{SHORT}	V _{OUT} =0V		0.7		A
Shutdown Supply Current	I _{SHUTDOWN}	Chip Disable, Shutdown Mode		0.1	1	μA
Enable High Input Threshold	V _{ENH}		1.6		5.5	V
Enable Low Input Threshold	V _{ENL}		0		1.0	V
Enable Pin Input Current	I _{EN}	Force 0V to 5.0V at EN Pin	-1.0		1.0	μA
Under Voltage Lockout Threshold Voltage	V _{UVLO}	V _{IN} Increasing from 0V	2.2	2.5	2.7	V
Under Voltage Hysteresis	V _{UVLOHY}			0.2		V
Reverse Current	I _{REVERSE}	Chip Disable, V _{OUT} >V _{IN}		0.1	1.0	μA
Output Pull Low Resistance after Shutdown	R _{DISCHARGE}	AP2805A, AP2805C only		100	200	Ω
Output Turn-on Time	t _{ON}	From Enable Active to 90% of Output		500		μs
Flag Delay Time	t _{DFLG}	From Fault Condition to Flag Active	5	10	15	ms
Flag Low Voltage	V _{FLG}	I _{SINK} =5.0mA		35	70	mV
Flag Leakage Current	I _{LEAKAGE}	FLAG Disable, Force 5.0V			1.0	μA
Thermal Shutdown Temperature	T _{OTSD}			150		°C
Thermal Shutdown Hysteresis	T _{HYOTSD}			30		°C

Typical Performance Characteristics

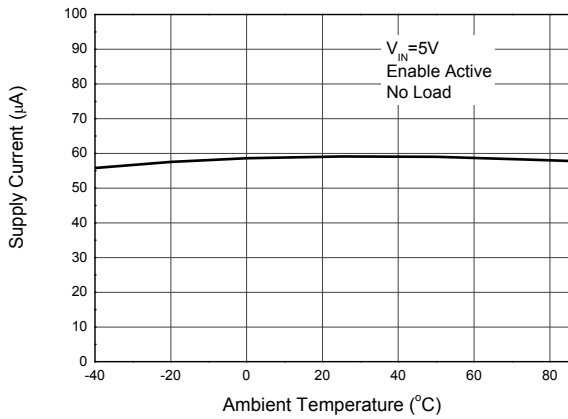

Figure 4. Supply Current vs. Ambient Temperature

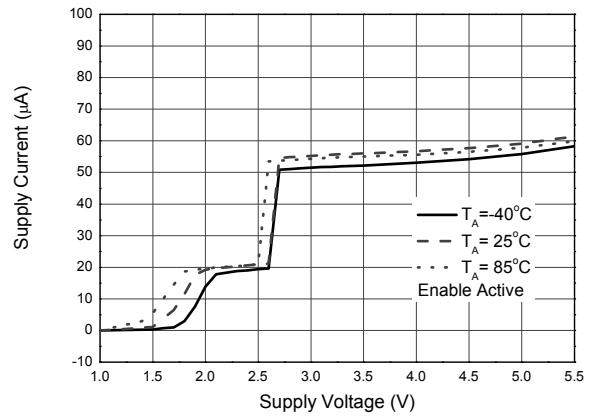

Figure 5. Supply Current vs. Supply Voltage

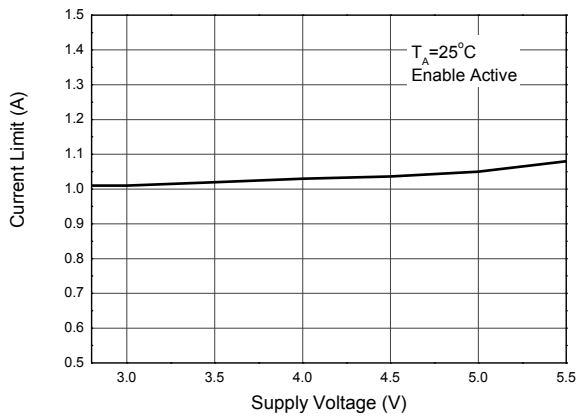

Figure 6. Current Limit vs. Supply Voltage

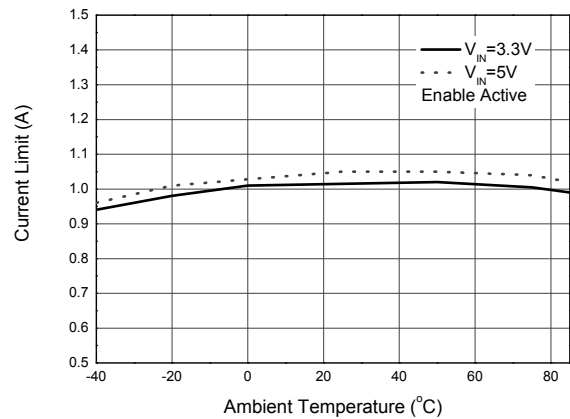

Figure 7. Current Limit vs. Ambient Temperature

Typical Performance Characteristics (Continued)

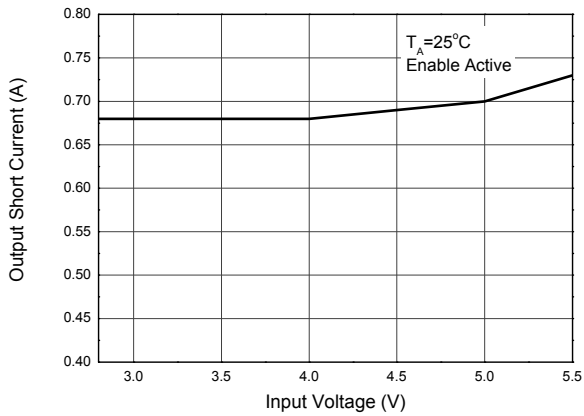

Figure 8. Output Short Current vs. Input Voltage

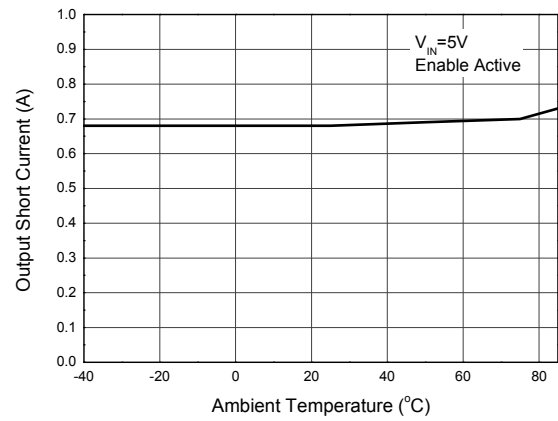

Figure 9. Output Short Current vs. Ambient Temperature

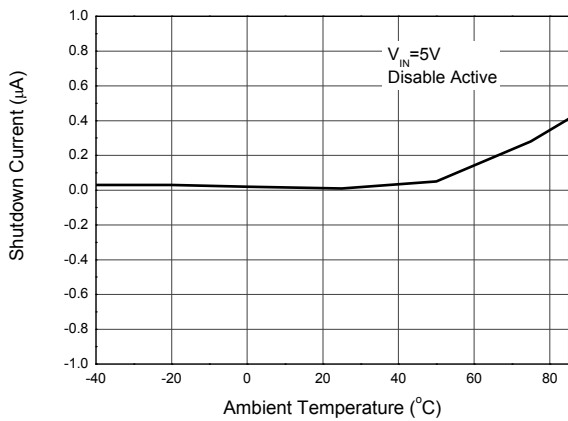

Figure 10. Shutdown Current vs. Ambient Temperature

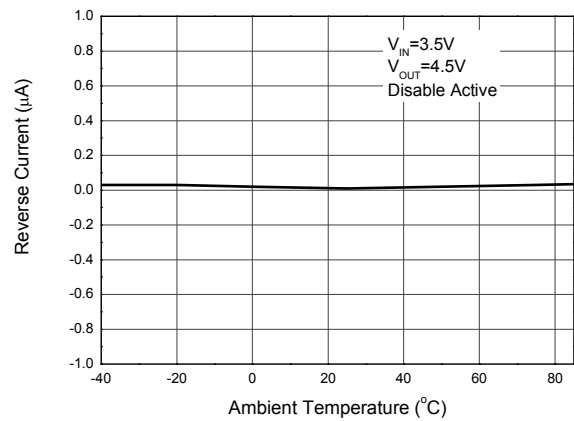

Figure 11. Reverse Current vs. Ambient Temperature

Typical Performance Characteristics (Continued)

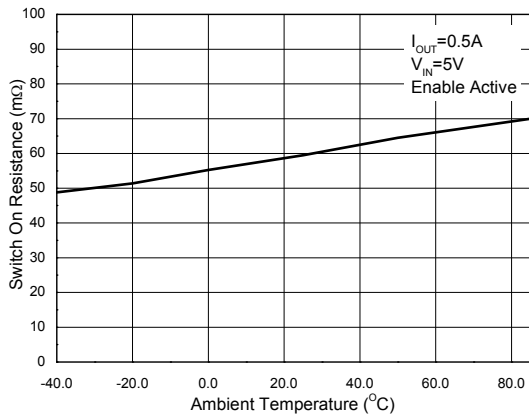

Figure 12. Switch On Resistance vs. Ambient Temperature

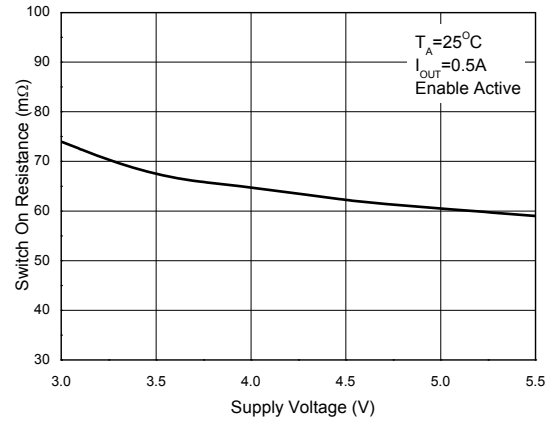

Figure 13. Switch On Resistance vs. Supply Voltage

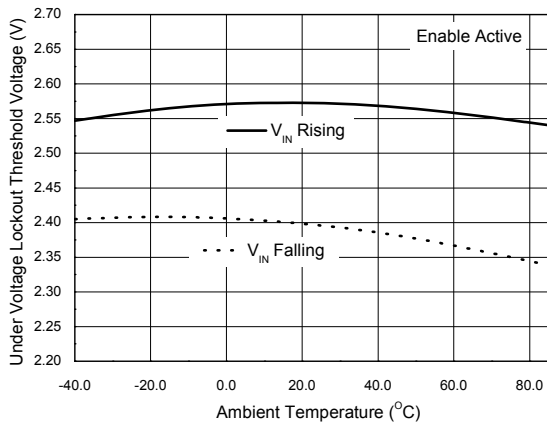

Figure 14. Under Voltage Lockout Threshold Voltage vs. Ambient Temperature

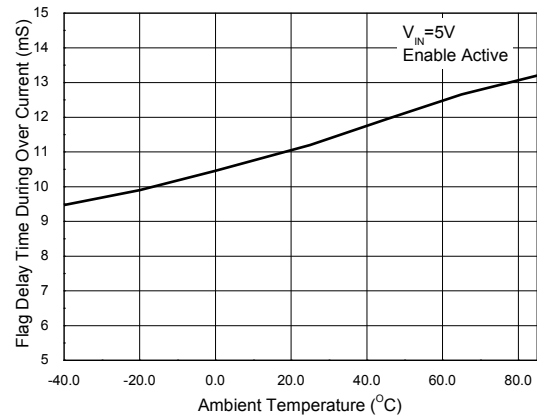

Figure 15. Flag Delay Time During Over Current vs. Ambient Temperature

Typical Performance Characteristics (Continued)

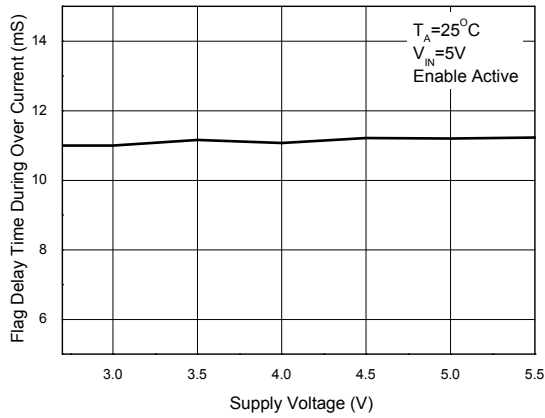

Figure 16. Flag Delay Time During Over Current vs. Supply Voltage

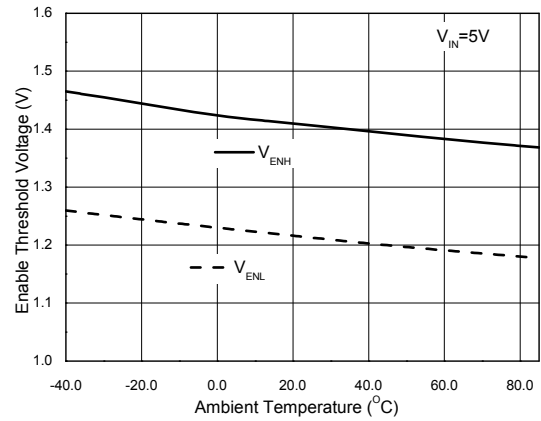

Figure 17. Enable Threshold Voltage vs. Ambient Temperature

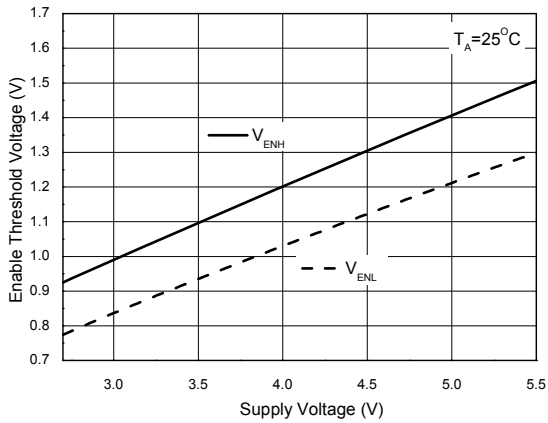

Figure 18. Enable Threshold Voltage vs. Supply Voltage

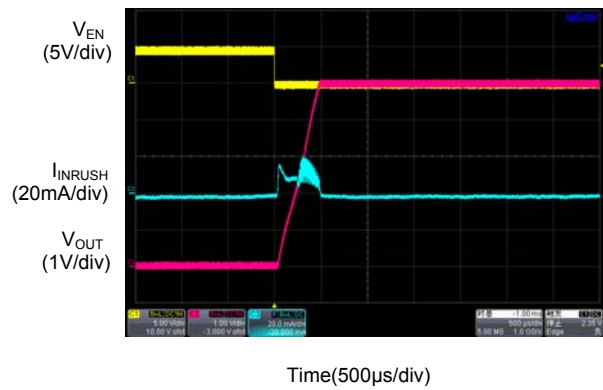

Figure 19. Output Turn ON and Rise Time (C_{IN}=1.0µF, C_{OUT}=1.0µF, No Load)

Typical Performance Characteristics (Continued)



Time(500µs/div)

Figure 20. Output Turn ON and Rise Time
($C_{IN}=1.0\mu F, C_{OUT}=1.0\mu F, R_L=6.6\Omega$)



Time(500µs/div)

Figure 21. Output Turn ON and Rise Time
($C_{IN}=1.0\mu F, C_{OUT}=47\mu F, \text{No Load}$)

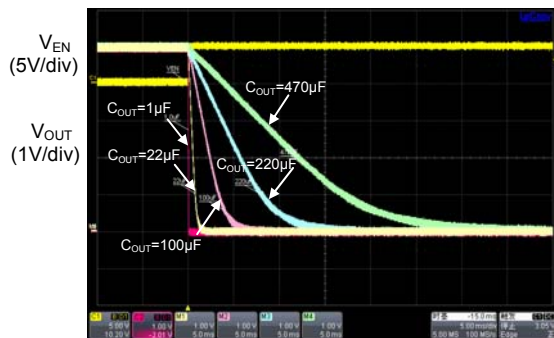

Time(5ms/div)

Figure 22. Output Turn OFF and Falling Time
($V_{IN}=5V, C_{IN}=1.0\mu F, \text{No Load}$)

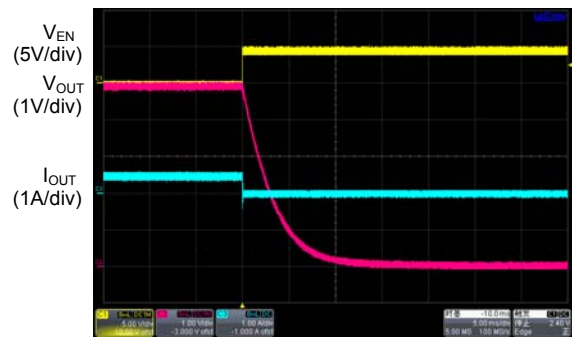

Time(5ms/div)

Figure 23. Output Turn OFF and Falling Time
($V_{IN}=5V, C_{IN}=1.0\mu F, C_{OUT}=470\mu F, R_L=6.6\Omega$)

Typical Performance Characteristics (Continued)



Time(100ms/div)

Figure 24. Output Short to GND Current
($V_{IN}=5V, C_{IN}=1.0\mu F$)



Time(5ms/div)

Figure 25. FLAG Response During Over Current
($V_{IN}=5V, C_{IN}=1.0\mu F, C_{OUT}=470\mu F$)

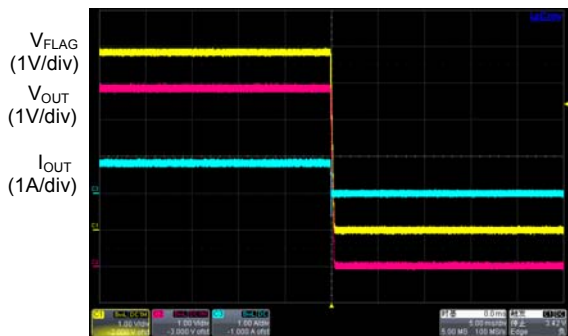

Time(5ms/div)

Figure 26. FLAG Response During Over Temperature
($V_{IN}=5V, C_{IN}=1.0\mu F, C_{OUT}=220\mu F, R_L=6.6\Omega$)

Typical Application

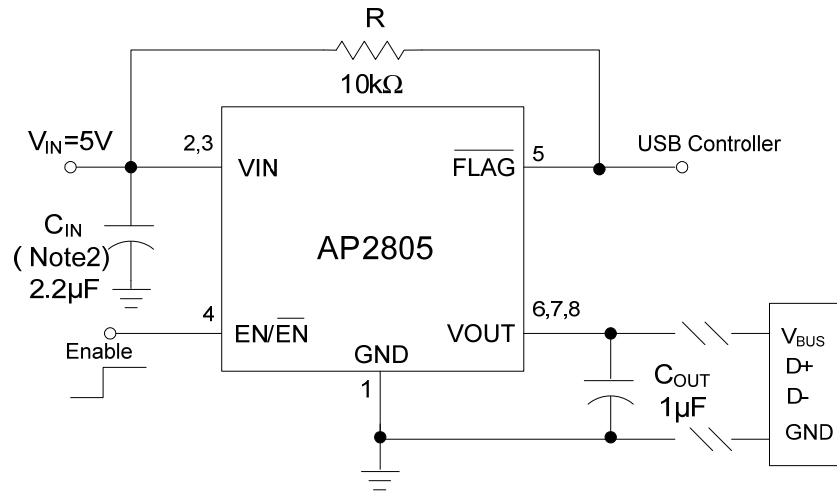

Note 2: 2.2µF input capacitor is enough in most application cases.

If the VOUT is short to ground frequently during usage, large size input capacitor is necessary, recommend 22µF.

Figure 27. Typical Application of AP2805

Mechanical Dimensions (Continued)

MSOP-8

Unit: mm(inch)

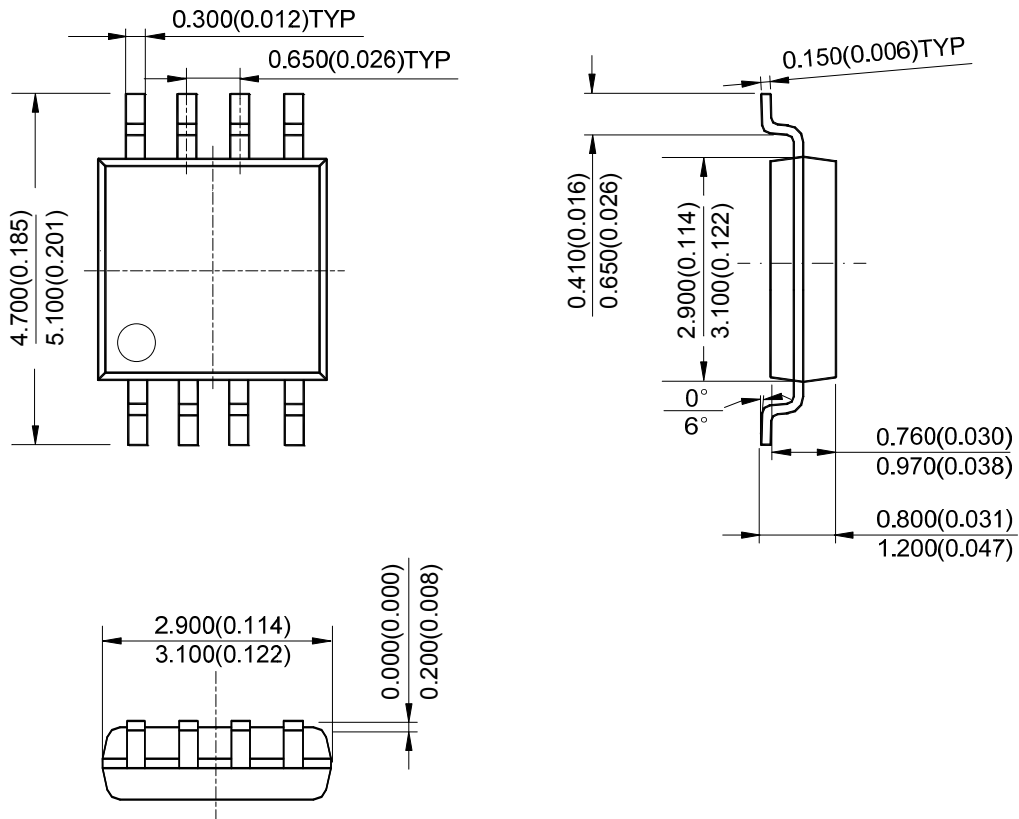

Note: Eject hole, oriented hole and mold mark is optional.



BCD Semiconductor Manufacturing Limited

<http://www.bcdsemi.com>

IMPORTANT NOTICE

BCD Semiconductor Manufacturing Limited reserves the right to make changes without further notice to any products or specifications herein. BCD Semiconductor Manufacturing Limited does not assume any responsibility for use of any its products for any particular purpose, nor does BCD Semiconductor Manufacturing Limited assume any liability arising out of the application or use of any its products or circuits. BCD Semiconductor Manufacturing Limited does not convey any license under its patent rights or other rights nor the rights of others.

MAIN SITE

- Headquarters

BCD Semiconductor Manufacturing Limited

No. 1600, Zi Xing Road, Shanghai ZiZhu Science-based Industrial Park, 200241, China
Tel: +86-21-24162266, Fax: +86-21-24162277

- Wafer Fab

Shanghai SIM-BCD Semiconductor Manufacturing Co., Ltd.

800 Yi Shan Road, Shanghai 200233, China
Tel: +86-21-6485 1491, Fax: +86-21-5450 0008

REGIONAL SALES OFFICE

Shenzhen Office

Shanghai SIM-BCD Semiconductor Manufacturing Co., Ltd., Shenzhen Office

Unit A Room 1203, Skyworth Bldg., Gaoxin Ave. 1.S., Nanshan District, Shenzhen, China
Tel: +86-755-8826 7951
Fax: +86-755-8826 7865

Taiwan Office

BCD Semiconductor (Taiwan) Company Limited

4F, 298-1, Rui Guang Road, Nei-Hu District, Taipei, Taiwan
Tel: +886-2-2656 2808
Fax: +886-2-2656 2806



USA Office

BCD Semiconductor Corp.

30920 Huntwood Ave. Hayward, CA 94544, USA
Tel : +1-510-324-2988
Fax: +1-510-324-2788

Looking for pricing, stock, or lifecycle information?

Click below to explore more details on WIN SOURCE:

-  [View AP2805AMMTR-G1 on WIN SOURCE](#)
-  [Diodes Incorporated Information](#)

Optimize Your Supply Chain with WIN SOURCE Solutions

-  Global Sourcing Solution
-  Obsolete Management
-  Cost Control Management
-  Shortage Management
-  Alternative Solution
-  Excess Inventory Management