



# THE DATASHEET OF SF2042B



- *Designed for 802.16 and WIMAX Receiver IF Application*
- *Low Insertion Loss*
- *5.0 X 7.0 mm Surface-Mount Case*
- *Differential Input and Output*
- *Complies with Directive 2002/95/EC (RoHS)*
- *Moisture Sensitivity Level: 1*
- *AEC-Q200 Qualified*

**Absolute Maximum Ratings**

Rating	Value	Units
Maximum Incident Power in Passband	+13	dBm
Max. DC voltage between any 2 terminals	30	VDC
Storage Temperature Range	-40 to +85	°C
Suitable for lead-free soldering - Max Soldering Profile	260°C for 30 s	

**SF2042B**

**456.00 MHz  
SAW Filter**

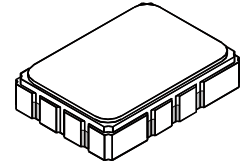

**SMP-03**

**Electrical Characteristics**

Characteristic	Sym	Notes	Min	Typ	Max	Units
Nominal Center Frequency @ 25°C	CF			456.00		MHz
Insertion Loss @ 25°C				12	14	dB
Differential Impedance line-to-line				200		Ohms
Passband 1dB			±6.4	±7.5		MHz
Passband 3dB			±7.5	±8.8		
Group Delay		Absolute Group Delay Variation; CF ±6.4 MHz		50	150	nsec
		Return Loss	8	15		dB
Rejection		DC to 256 MHz	30	55		dB
		256 to 360 MHz	36	50		
		360 to 416	36	40		
		416 to 443 MHz	25	35		
		470 to 656 MHz	32	35		
		656 to 946 MHz	30	50		
Equivalent Circuit		Input 320 ohm		5.1		pF
		Output 400 ohm		4.5		pF
Center Frequency Temperature Coefficient				-15		kHz/°C
Maximum Peak RF Input Power					13	dBm
Temperature		Operating	-40		85	°C
		Storage	-40		85	
Case Style			SMP-03 5 x 7 mm Nominal Footprint			
Lid Symbolization (YY=year, WW=week, S=shift, ## = Sequence Code)			RFM, SF2042B, YYWWS##			

 **CAUTION: Electrostatic Sensitive Device. Observe precautions for handling.**

**NOTES:**

1. The design, manufacturing process, and specifications of this device are subject to change.
2. US or International patents may apply.
3. RoHS compliant from the first date of manufacture.

# SMP-03 Case

## 10-Terminal Ceramic Surface-Mount Case 7 x 5 mm Nominal Footprint

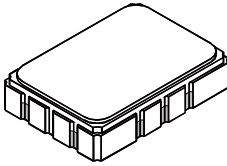

Recommended PCB Footprint

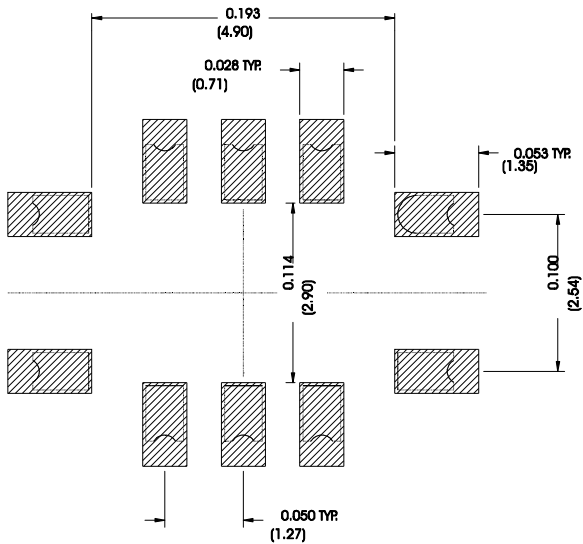

Case Dimensions						
Dimension	mm			Inches		
	Min	Nom	Max	Min	Nom	Max
A	6.80	7.00	7.20	0.268	0.276	0.283
B	4.80	5.00	5.20	0.189	0.197	0.205
C		1.65	2.00		0.065	0.079
D	.47	0.60	.73	0.019	0.024	0.029
E	2.41	2.54	2.67	0.095	0.100	0.105
H	0.87	1.0	1.13	0.034	0.039	0.044
J	4.87	5.00	5.13	0.192	0.197	0.202
K	2.87	3.00	3.13	0.113	0.118	0.123
P	1.14	1.27	1.40	0.045	0.050	0.055

Materials	
Solder Pad Termination	Au plating 30 - 60 ulnches (76.2-152 uM) over 80-200 ulnches (203-508 uM) Ni.
Lid	Fe-Ni-Co Alloy Electroless Nickel Plate (8-11% Phosphorus) 100-200 ulnches Thick
Body	Al <sub>2</sub> O <sub>3</sub> Ceramic

Electrical Connections		
Connection		Terminals
Port 1	Input or Return	10
	Return or Input	1
Port 2	Output or Return	5
	Return or Output	6
Ground		All others
Single Ended Operation		Return is ground
Differential Operation		Return is hot

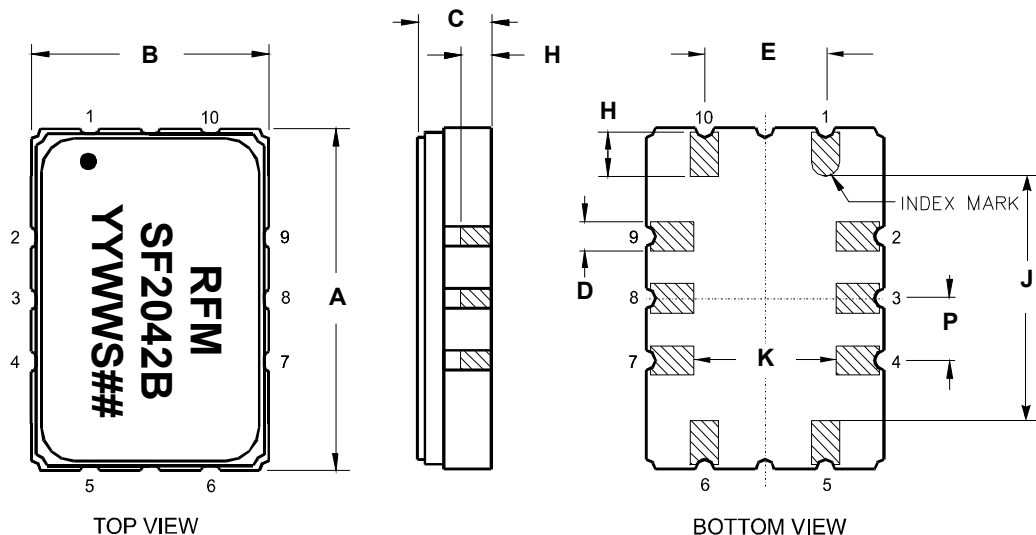

## Tape and Reel Specifications

Tape and Reel Standard per ANSI/EIA-481

"B"		Quantity Per Reel
Inches	millimeters	
7	178	500
13	330	2000

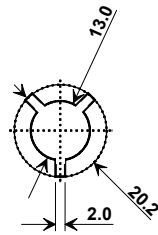
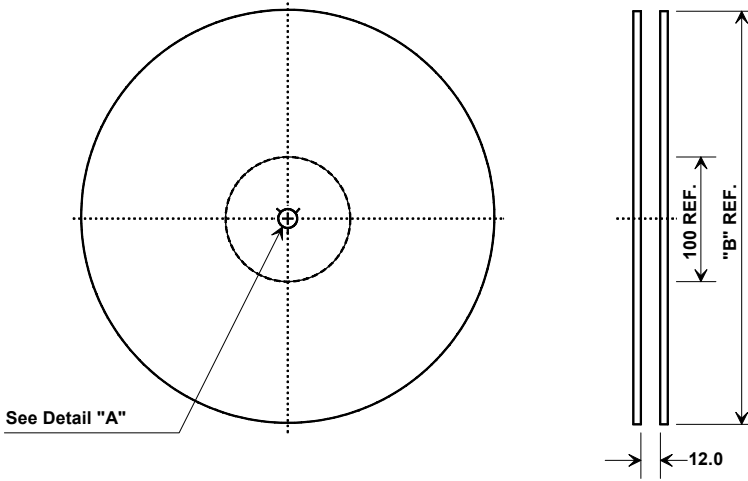

### COMPONENT ORIENTATION and DIMENSIONS

Carrier Tape Dimensions		Tolerance
Ao	5.5 mm	± 0.1mm
Bo	7.5 mm	± 0.1mm
Ko	2.0 mm	± 0.1mm
Pitch	8.0 mm	± 0.1mm
W	16.0 mm	± 0.2mm

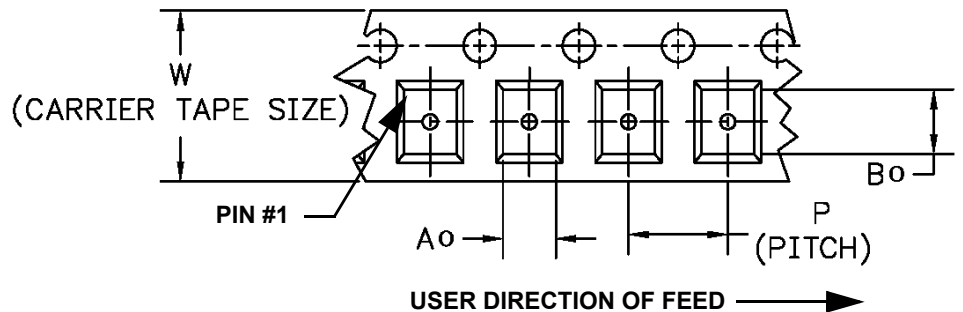
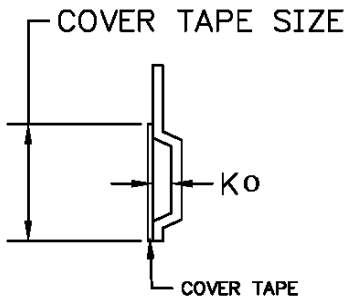

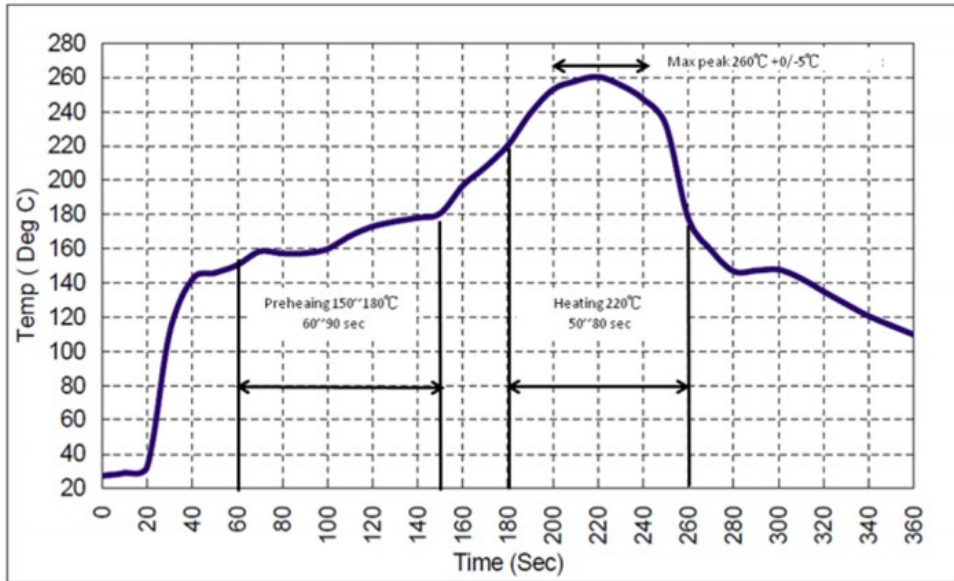

## Recommended Reflow Profile

1. Preheating shall be fixed at 150~180°C for 60~90 seconds.
2. Ascending time to preheating temperature 150°C shall be 30 seconds min.
3. Heating shall be fixed at 220°C for 50~80 seconds and at 260°C +0/-5°C peak (10 seconds).
4. Time: 5 times maximum.



## Looking for pricing, stock, or lifecycle information?

Click below to explore more details on WIN SOURCE:

-  [View SF2042B on WIN SOURCE](#)
-  [RF Monolithics, Inc Information](#)

## Optimize Your Supply Chain with WIN SOURCE Solutions

-  Global Sourcing Solution
-  Obsolete Management
-  Cost Control Management
-  Shortage Management
-  Alternative Solution
-  Excess Inventory Management