



# THE DATASHEET OF OP290C



# Plastic Infrared Emitting Diode



## OP290 Series

Obsolete [OP291 (B, C), OP292 (B, C), OP293C, OP295C, OP296C, OP297 (B, C), OP298 (AB, AC, AD)]



### Features:

- Choice of narrow or wide irradiance pattern
- Choice of power ranges
- Choice of T-1¾, TO-18 or TO-46 package
- Higher power output than GaAs at equivalent LEDs

### Description:

Each device in this series, is a gallium aluminum arsenide infrared Light Emitting Diode (LED) that is molded in an IR-transmissive package with a wavelength centered at 890 nm, which closely matches the spectral response of silicon phototransistors, except for OP298AA, which has an 875 nm center wavelength. For identification purposes, each LED anode lead is longer than the cathode lead. **Package T-1¾** devices include: **OP290 (A, B, C), OP291A, OP292A, OP294 (A, B, C), OP295 (A, B), OP296 (A, B), OP297A, OP299 (A, B, C)** and **OP297FAB, Plastic Package TO-18 or TO-46** devices include: **OP293 (A, B)** and **OP298 (A, B, C, AA)**.

The **OP290** series forward current is specified under pulse conditions up to 1.5 amps, the **OP291A** forward current is specified under pulse conditions up to 100 milliamps and the **OP292A** forward current is specified under pulse conditions up to 1 amp. The Cathode Lead length is 0.06" (1.52 mm) shorter than the Anode Lead. The silver-copper lead frame offers excellent thermal characteristics.

The **OP293 (A, B)** have an included emission angle of 60° while the **OP298 (A, B, C)** have an included emission angle of 25°. The Cathode Lead length is 0.06" (1.52 mm) shorter than the Anode Lead. These devices, which come in a variety of power ranges offering a low cost replacement for TO-18 or TO-46 hermetic packages.

The OP298AA is a high irradiance output version with an included emission angle of 25°. The Cathode Lead length is 0.06" (1.52 mm) shorter than the Anode Lead. These devices, which come in a variety of power ranges offering a low cost replacement for TO-18 or TO-46 hermetic packages.

**OP294** and **OP299** are designed for low-current or power-limited applications, such as battery supplies. They are similar to the **OP290** and **OP295**, but use a smaller chip that increases output efficiency at low current levels by increasing current density. Light output can be maximized with continuous (D.C.) forward current up to 100 mA or with pulsed forward current up to 750 mA. The Cathode Lead length is 0.06" (1.52 mm) shorter than the Anode Lead.

The **OP295 (A, B)** forward current is specified under pulse conditions up to 5 amps, the **OP296 (A, B)** forward current is specified under pulse conditions up to 2 amps and the **OP297A** forward current is specified under pulse conditions up to 1 amp. The Cathode Lead length is 0.06" (1.52 mm) shorter than the Anode Lead. The **OP297FAB** has a reversed polarity from the **OP297A**. The silver-copper lead frame offers excellent thermal characteristics.

*All of these devices are spectrally and mechanically matched to the OP593 and OP598 series phototransistors.*

*Please refer to Application Bulletins 208 and 210 for additional design information and reliability (degradation) data.*

### Applications:



- Non-contact reflective object sensor
- Machine automation
- Door sensor
- Assembly line automation
- Machine safety
- Battery-operated applications
- End of travel sensor

#### General Note

TT Electronics reserves the right to make changes in product specification without notice or liability. All information is subject to TT Electronics' own data and is considered accurate at time of going to print.

TT Electronics | OPTEK Technology  
2900 E. Plano Pkwy, Plano, TX 75074 | Ph: +1 972 323 2200  
www.ttelectronics.com | sensors@ttelectronics.com

# Plastic Infrared Emitting Diode

## OP290 Series

Obsolete [OP291 (B, C), OP292 (B, C), OP293C, OP295C, OP296C, OP297 (B, C), OP298 (AB, AC, AD)]



### Part Number Guide — OP290 - OP299 Series

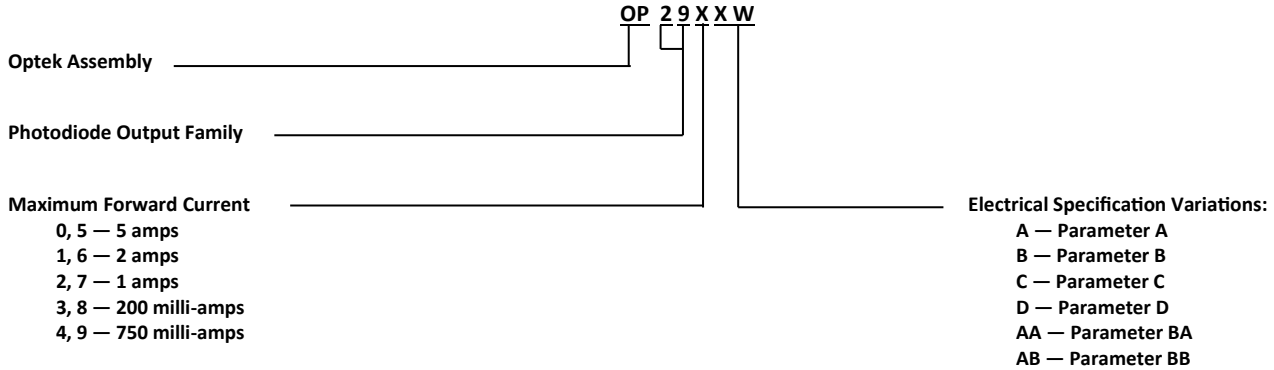

### T-1½ Package OP290, OP291, OP292, OP294, OP295, OP296, OP297, OP299

#### Electrical Connection A, B, C

Pin #	LED X = 0.060" (1.52 mm)
1	Anode
2	Cathode

#### Electrical Connection OP297FAB

Pin #	LED X = 0.060" (1.52 mm)
1	Cathode
2	Anode

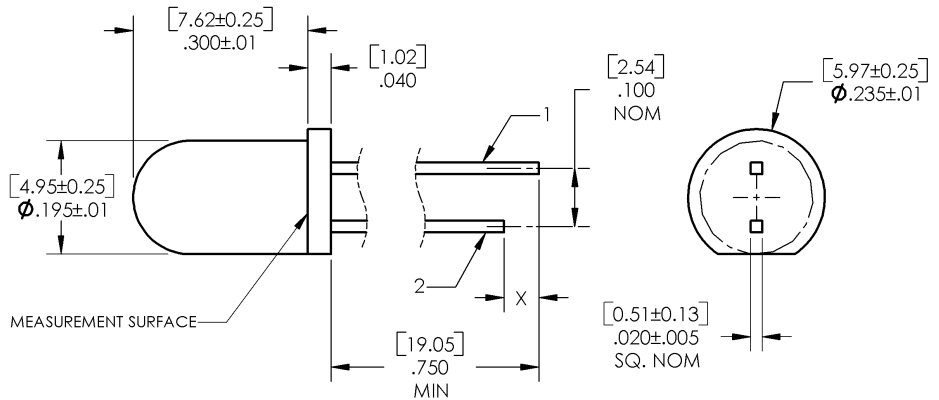

### TO-18, TO-46 Package OP293 & OP298



#### Electrical Connection A, B, C, AA

Pin #	LED X = 0.060" (1.52 mm)
1	Anode
2	Cathode

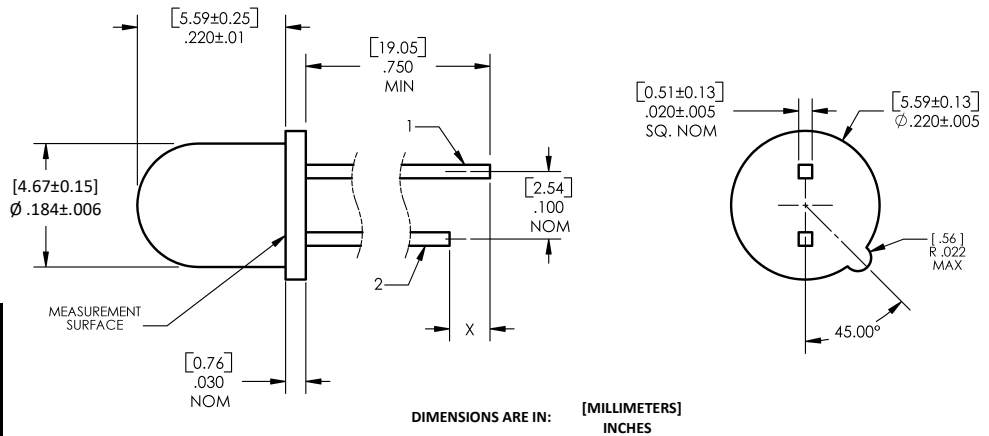

#### General Note

TT Electronics reserves the right to make changes in product specification without notice or liability. All information is subject to TT Electronics' own data and is considered accurate at time of going to print.

TT Electronics | OPTEK Technology  
2900 E. Plano Pkwy, Plano, TX 75074 | Ph: +1 972 323 2200  
www.ttelectronics.com | sensors@ttelectronics.com

# Plastic Infrared Emitting Diode

## OP290 Series

Obsolete [OP291 (B, C), OP292 (B, C), OP293C, OP295C,  
OP296C, OP297 (B, C), OP298 (AB, AC, AD)]



### Electrical Specifications

#### Absolute Maximum Ratings ( $T_A = 25^\circ\text{C}$ unless otherwise noted)

Storage and Operating Temperature Range	-40° C to +100° C
Reverse Voltage OP290, OP292, OP294, OP295, OP297, OP299 OP291, OP293, OP296, OP298	5.0 V 2.0 V
Continuous Forward Current OP290, OP291, OP292 OP294, OP295, OP299 OP295, OP296, OP297	150 mA <sup>(1)</sup> 100 mA <sup>(1)</sup> 150 mA <sup>(1)</sup>
Continuous Forward Current, OP293, OP298 Free Air Board Mounted Full Heat Sink	100 mA 133 mA 200 mA
Peak Forward Current OP290, OP295 (25 $\mu\text{s}$ pulse width) OP291, OP296 (100 $\mu\text{s}$ pulse width) OP292, OP297 (100 $\mu\text{s}$ pulse width) OP293, OP298 (25 $\mu\text{s}$ pulse width) OP294, OP299	5.0 A 2.0 A 1.00 A 2.0 A 750 mA

#### Notes:

1. For OP290, OP291, OP292, OP295, OP296 and OP297, derate linearly 1.67 mA/° C above 25° C (free-air). When used with heat sink (see note 5), derate linearly 2.07 mA/° C above 65° C (normal use). For OP293 and OP298, when measured in free-air, derate power dissipation linearly 1.43 mW/° C above 25° C. For OP294 and OP299, derate linearly 1.80 mW/° C above 25° C.

#### General Note

TT Electronics reserves the right to make changes in product specification without notice or liability. All information is subject to TT Electronics' own data and is considered accurate at time of going to print.

TT Electronics | OPTEK Technology  
2900 E. Plano Pkwy, Plano, TX 75074 | Ph: +1 972 323 2200  
www.ttelectronics.com | sensors@ttelectronics.com

# Plastic Infrared Emitting Diode

## OP290 Series

Obsolete [OP291 (B, C), OP292 (B, C), OP293C, OP295C, OP296C, OP297 (B, C), OP298 (AB, AC, AD)]



### Electrical Specifications

#### Absolute Maximum Ratings ( $T_A = 25^\circ\text{C}$ unless otherwise noted)

Maximum Duty Cycle OP290 (25 $\mu\text{s}$ pulse width @ 5 A)	1.25 % <sup>(1)</sup>
Lead Soldering Temperature [1/16 inch (1.6 mm) from case for 5 seconds with soldering iron]	260° C <sup>(2)</sup>
Power Dissipation, Free Air OP290, OP291, OP292, OP295, OP296, OP297 OP293, OP298	333 mW <sup>(3)</sup> 142 mW <sup>(3)</sup>
Power Dissipation, Board Mounted OP290, OP291, OP292, OP295, OP296, OP297 OP293, OP298	533 mW <sup>(4)</sup> 200 mW <sup>(4)</sup>
Power Dissipation, Full Heat Sink OP290, OP291, OP292, OP295, OP296, OP297 OP293, OP298	1.11 W <sup>(5)</sup> 400 mW <sup>(5)</sup>
Power Dissipation OP294, OP299	180 mW

#### Notes:

- For OP290, OP291, OP292, OP295, OP296 and OP297, refer to graph of Maximum Peak Pulse Current vs Pulse Width.
- For all OPs in this series, RMA flux is recommended. Duration can be extended to 10 second maximum when soldering. A maximum of 20 grams force may be applied to the leads when flow soldering.
- For OP290, OP291, OP292, OP295, OP296 and OP297, measured in free-air. Derate linearly 3.33 mW/° C above 25° C.
- For OP290, OP291 and OP292, mounted on 1/16" (1.6 mm) thick PCBoard with each lead soldered through 80 mil square lands 0.250" (6.35 mm) below flange of device. Derate linearly 5.33 mW/° C above 62.5°. For OP293 and OP298, mounted on 1/16" (1.60 mm) thick PCBoard with each lead soldered through 80 mil square lands 0.250" (6.35 mm) below flange of device. Derate power dissipation linearly 2.00 mW/° C above 25° C (normal use). For OP295, OP296 and OP297, mounted on 1/16" (1.6 mm) thick PCBoard with each lead soldered through 80 mil square lands 0.250" (6.35 mm) below flange of device. Derate linearly 5.33 mW/° C above 25° C.
- Immersed in silicone fluid to simulate infinite heat sink. For OP290, OP291 and OP292, derate linearly 11.1 mW/° C above 95° C. For OP293 and OP298, derate power dissipation linearly 2.50 mW/° C above 25° C. For OP295, OP296 and OP297, derate linearly 11.1 mW/° C above 25° C.

#### General Note

TT Electronics reserves the right to make changes in product specification without notice or liability. All information is subject to TT Electronics' own data and is considered accurate at time of going to print.

TT Electronics | OPTEK Technology  
2900 E. Plano Pkwy, Plano, TX 75074 | Ph: +1 972 323 2200  
www.ttelectronics.com | sensors@ttelectronics.com

# Plastic Infrared Emitting Diode

## OP290 Series

Obsolete [OP291 (B, C), OP292 (B, C), OP293C, OP295C, OP296C, OP297 (B, C), OP298 (AB, AC, AD)]



### Electrical Specifications

Electrical Characteristics ( $T_A = 25^\circ \text{C}$  unless otherwise noted)

SYMBOL	PARAMETER	MIN	TYP	MAX	UNITS	TEST CONDITIONS
<b>Input Diode</b>						
$E_{E(APT)}^{(2)}$	Apertured Radiant Incidence					
	OP290A	210	-	-	mW/cm <sup>2</sup>	$I_F = 1.50 \text{ A}^{(1)(2)}$ Measured into a 0.250" [6.35 mm] aperture 0.2" (5.08 mm) from the tip of the lens.
	OP290B	180	-	300		
	OP290C	150	-	-		
	OP291A	16	-	-		$I_F = 100 \text{ mA}^{(1)(2)}$ Measured into a 0.250" [6.35 mm] aperture 0.2" (5.08 mm) from the tip of the lens.
	OP293A	16	-	-		
	OP293B	13	22	26		
	OP298A	3.0	-	-		
	OP298B	2.4	-	4.8		
	OP298C	1.8	-	-		
OP292A	2.7	-	-	$I_F = 20 \text{ mA}^{(1)(2)}$ Measured into a 0.250" [6.35 mm] aperture 0.2" (5.08 mm) from the tip of the lens.		
OP294	0.50	-	1.50	$I_F = 5 \text{ mA}^{(1)(2)}$ Measured into a 0.250" [6.35 mm] aperture 0.200" (5.08mm) from the tip of the lens.		
OP295A	44	-	-	$I_F = 1.50 \text{ A}^{(1)(2)}$ Measured into a 0.250" [6.35 mm] aperture 1.129" (28.7 mm) from the tip of the lens.		
OP295B	33	-	77			
OP296A	3.6	-	-	$I_F = 100 \text{ mA}^{(1)(2)}$ Measured into a 0.250" [6.35 mm] aperture 1.129" (28.7 mm) from the tip of the lens.		
OP296B	2.6	-	6.6			
OP298AA	3.5	-	-			
OP299	0.15	-	0.45			
OP297FAB	2.4	-	-	$I_F = 20 \text{ mA}^{(1)(2)}$ Measured into a 0.250" [6.35 mm] aperture 1.129" (28.7 mm) from the tip of the lens.		
OP297A	0.7	-	-			

**Notes:**

1. Measurement is taken at the end of a single 100  $\mu\text{s}$  pulse. Heating due to increased pulse rate or pulse width will cause a decrease in reading.
2. Measurement of the average apertured radiant energy incident upon a sensing area 0.250" (6.35 mm) in diameter perpendicular to and centered on the mechanical axis of the lens and the specified distance from the end of the device. On all models in this series,  $E_{E(APT)}$  is not necessarily uniform within the measured area.
3. Measurement is taken at the end of a single 10 ms pulse. Heating due to increased pulse rate or pulse width will cause a decrease in reading.

**General Note**

TT Electronics reserves the right to make changes in product specification without notice or liability. All information is subject to TT Electronics' own data and is considered accurate at time of going to print.

TT Electronics | OPTEK Technology  
2900 E. Plano Pkwy, Plano, TX 75074 | Ph: +1 972 323 2200  
www.ttelectronics.com | sensors@ttelectronics.com

# Plastic Infrared Emitting Diode

## OP290 Series

Obsolete [OP291 (B, C), OP292 (B, C), OP293C, OP295C, OP296C, OP297 (B, C), OP298 (AB, AC, AD)]



### Electrical Specifications

Electrical Characteristics (T<sub>A</sub> = 25° C unless otherwise noted)

SYMBOL	PARAMETER	MIN	TYP	MAX	UNITS	TEST CONDITIONS
<b>Input Diode</b>						
V <sub>F</sub>	Forward Voltage <sup>(3)</sup>	-	-	-	-	-
	OP290, OP295	-	-	4.00	V	I <sub>F</sub> = 1.50 A
	OP291, OP296	-	-	2.00		I <sub>F</sub> = 100 mA
	OP292, OP297, OP297FAB	-	-	1.75		I <sub>F</sub> = 20 mA
	OP293 (A, B), OP298 (A, B, C)	-	-	2.00		I <sub>F</sub> = 1.50 A
	OP298AA	-	-	2.00		I <sub>F</sub> = 100 mA
OP294, OP299	-	-	1.50	I <sub>F</sub> = 5 mA		
I <sub>R</sub>	Reverse Current <sup>(3)</sup>	-	-	-	μA	-
	OP290, OP292	-	-	10		V <sub>R</sub> = 5 V
	OP291, OP293, OP298 (A, B, C), OP296	-	-	100		V <sub>R</sub> = 2 V
	OP298AA	-	-	100		V <sub>R</sub> = 2 V
	OP294, OP299	-	-	10		V <sub>R</sub> = 2 V
	OP295, OP297 OP297FAB	-	-	10 15		V <sub>R</sub> = 5 V V <sub>R</sub> = 5 V
λ <sub>P</sub>	Wavelength at Peak Emission	-	890	-	nm	I <sub>F</sub> = 10 mA
	OP290 (A, B, C), OP291A, OP292A, OP293 (A, B), OP294 (A, B, C), OP295 (A, B), OP296 (A, B), OP297A, OP298 (A, B, C), OP299 OP297FAB, OP298AA	-	875	-		
B	Spectral Bandwidth between Half Power Points	-	80	-	nm	I <sub>F</sub> = 10 mA
Δλ <sub>P</sub> /ΔT	Spectral Shift with Temperature	-	+0.18	-	nm/° C	I <sub>F</sub> = Constant
θ <sub>HP</sub>	Emission Angle at Half Power Points	-	-	-	Degree	I <sub>F</sub> = 20 mA
	OP290, OP291, OP292, OP294	-	50	-		
	OP293	-	60	-		
	OP295, OP296, OP297, OP299	-	20	-		
	OP298	-	25	-		
t <sub>r</sub>	Output Rise Time	-	500	-	ns	I <sub>F(PK)</sub> = 100 mA, PW = 10 μs, and D.C. = 10.0 %
t <sub>f</sub>	Output Fall Time	-	250	-	ns	

Notes:

- Measurement is taken at the end of a single 100 μs pulse. Heating due to increased pulse rate or pulse width will cause a decrease in reading.
- Measurement of the average apertured radiant energy incident upon a sensing area 0.250" (6.35 mm) in diameter perpendicular to and centered on the mechanical axis of the lens and the specified distance from the end of the device. On all models in this series, E<sub>E(APT)</sub> is not necessarily uniform within the measured area.
- Measurement is taken at the end of a single 10 ms pulse. Heating due to increased pulse rate or pulse width will cause a decrease in reading.

General Note

TT Electronics reserves the right to make changes in product specification without notice or liability. All information is subject to TT Electronics' own data and is considered accurate at time of going to print.

TT Electronics | OPTEK Technology  
2900 E. Plano Pkwy, Plano, TX 75074 | Ph: +1 972 323 2200  
www.ttelectronics.com | sensors@ttelectronics.com

# Plastic Infrared Emitting Diode

## OP290 Series

Obsolete [OP291 (B, C), OP292 (B, C), OP293C, OP295C, OP296C, OP297 (B, C), OP298 (AB, AC, AD)]



### Performance

OP290, OP291, OP292, OP293, OP294

Forward Voltage vs Forward Current vs Temp.

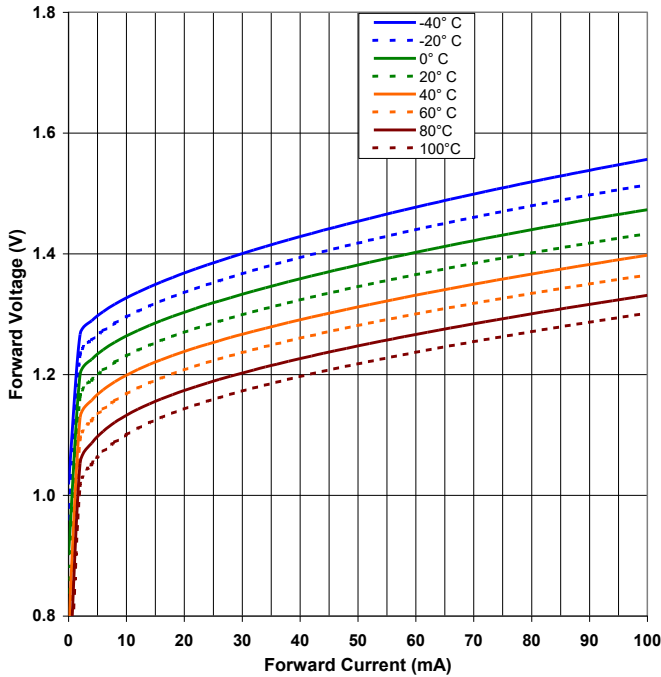

Optical Power vs Forward Current vs Temperature

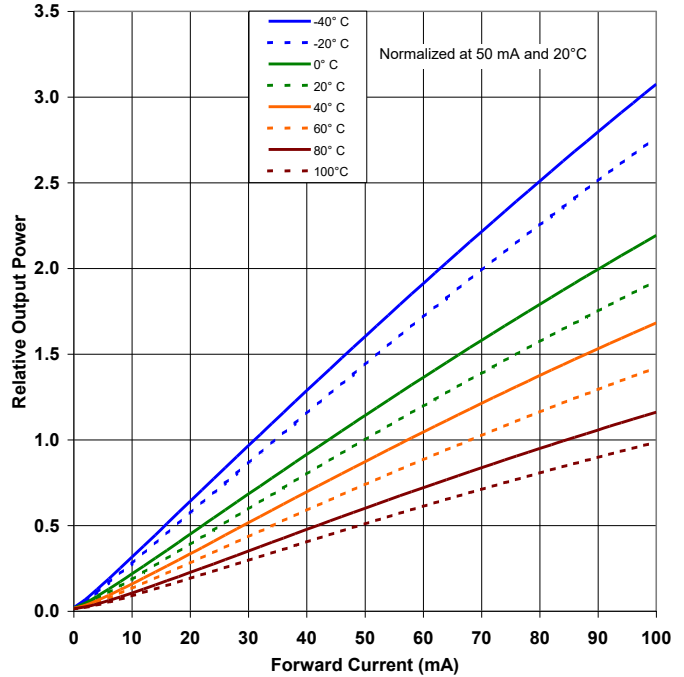

Distance vs Output Power vs Forward Current

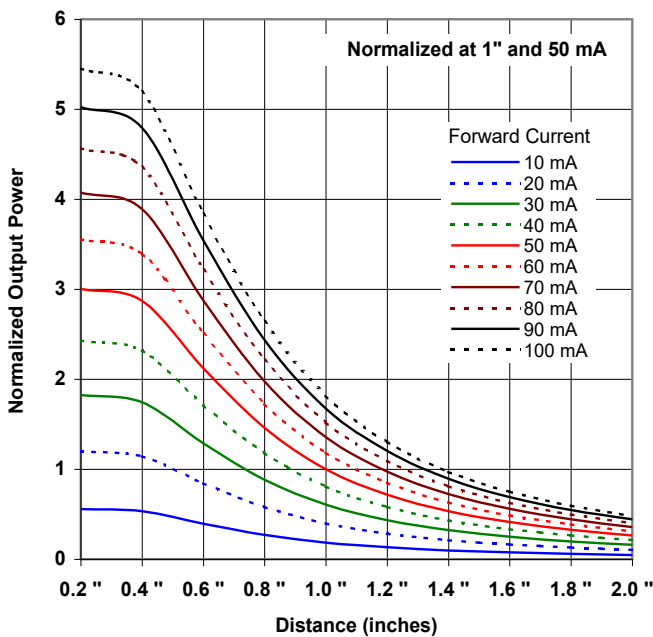

Relative Radiant Intensity vs. Angular Displacement

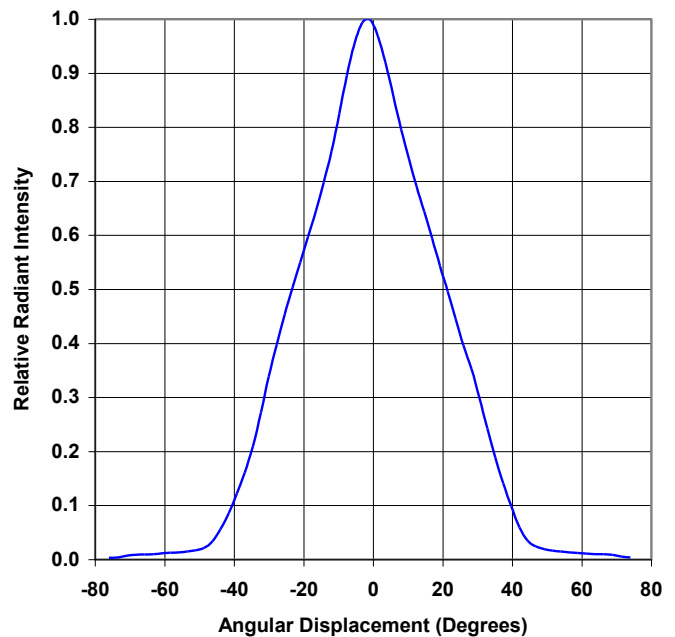

General Note

TT Electronics reserves the right to make changes in product specification without notice or liability. All information is subject to TT Electronics' own data and is considered accurate at time of going to print.

TT Electronics | OPTEK Technology  
2900 E. Plano Pkwy, Plano, TX 75074 | Ph: +1 972 323 2200  
www.ttelectronics.com | sensors@ttelectronics.com

# Plastic Infrared Emitting Diode

## OP290 Series

Obsolete [OP291 (B, C), OP292 (B, C), OP293C, OP295C, OP296C, OP297 (B, C), OP298 (AB, AC, AD)]



### Performance

OP295, OP296, OP297, OP298, OP299

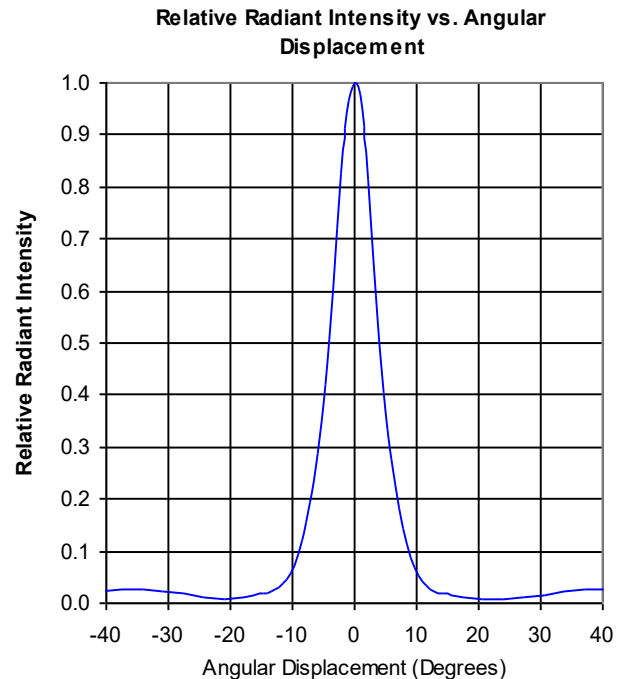
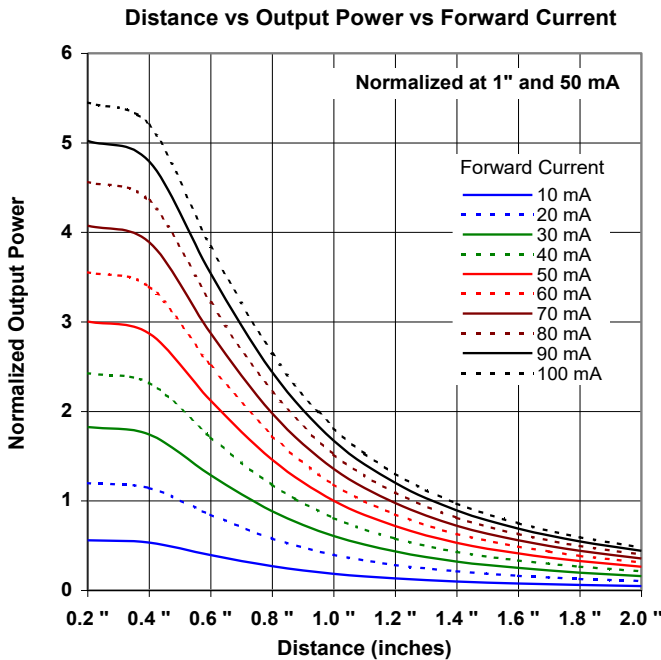
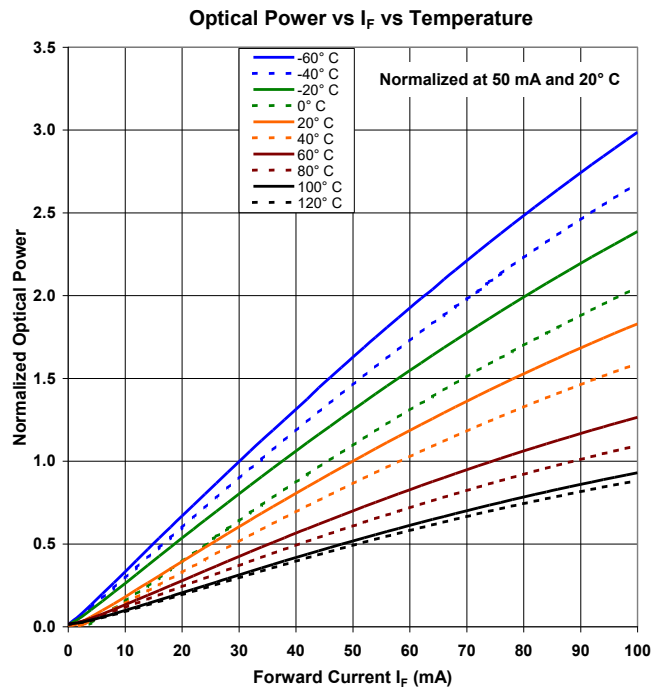
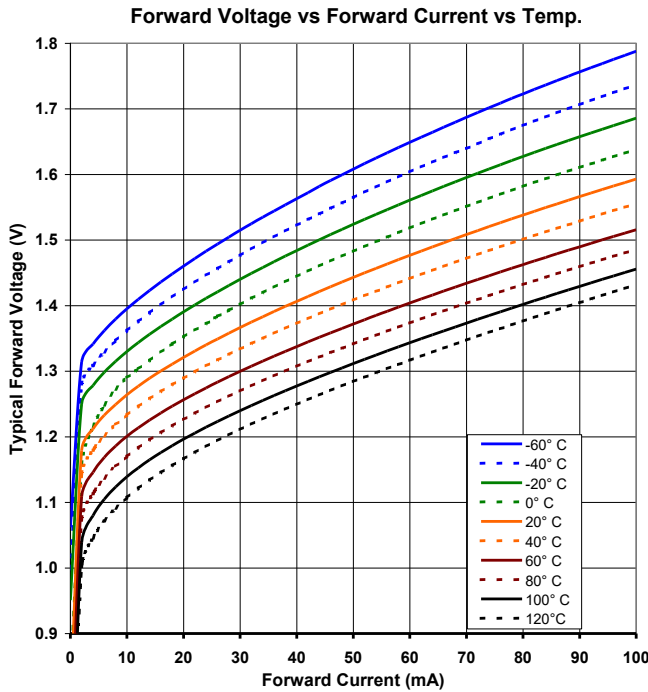

**General Note**

TT Electronics reserves the right to make changes in product specification without notice or liability. All information is subject to TT Electronics' own data and is considered accurate at time of going to print.

TT Electronics | OPTEK Technology  
2900 E. Plano Pkwy, Plano, TX 75074 | Ph: +1 972 323 2200  
www.ttelectronics.com | sensors@ttelectronics.com

# Plastic Infrared Emitting Diode

## OP290 Series

Obsolete [OP291 (B, C), OP292 (B, C), OP293C, OP295C, OP296C, OP297 (B, C), OP298 (AB, AC, AD)]



### Performance

#### OP290A/OP593 and OP295/OP598 - Coupling Characteristics

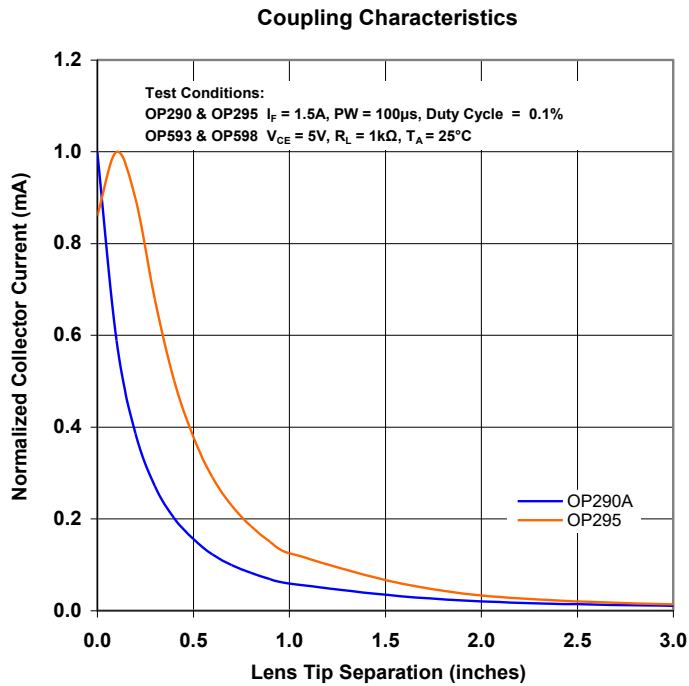

#### General Note

TT Electronics reserves the right to make changes in product specification without notice or liability. All information is subject to TT Electronics' own data and is considered accurate at time of going to print.

TT Electronics | OPTEK Technology  
2900 E. Plano Pkwy, Plano, TX 75074 | Ph: +1 972 323 2200  
www.ttelectronics.com | sensors@ttelectronics.com

## Looking for pricing, stock, or lifecycle information?

Click below to explore more details on WIN SOURCE:

 [View OP290C on WIN SOURCE](#)

 [TT Electronics](#) Information

## Optimize Your Supply Chain with WIN SOURCE Solutions

-  Global Sourcing Solution
-  Obsolete Management
-  Cost Control Management
-  Shortage Management
-  Alternative Solution
-  Excess Inventory Management