



**THE DATASHEET OF  
APT29F100L**



## N-Channel FREDFET

Power MOS 8™ is a high speed, high voltage N-channel switch-mode power MOSFET. This 'FREDFET' version has a drain-source (body) diode that has been optimized for high reliability in ZVS phase shifted bridge and other circuits through reduced  $t_{rr}$ , soft recovery, and high recovery  $dv/dt$  capability. Low gate charge, high gain, and a greatly reduced ratio of  $C_{rSS}/C_{iSS}$  result in excellent noise immunity and low switching loss. The intrinsic gate resistance and capacitance of the poly-silicon gate structure help control  $di/dt$  during switching, resulting in low EMI and reliable paralleling, even when switching at very high frequency.

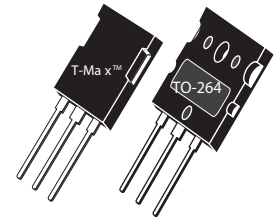
**APT29F100B2 APT29F100L**

Single die FREDFET

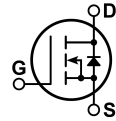

### FEATURES

- Fast switching with low EMI
- Low  $t_{rr}$  for high reliability
- Ultra low  $C_{rSS}$  for improved noise immunity
- Low gate charge
- Avalanche energy rated
- RoHS compliant 

### TYPICAL APPLICATIONS

- ZVS phase shifted and other full full bridge
- Half bridge
- PFC and other boost converter
- Buck converter
- Single and two switch forward
- Flyback

### Absolute Maximum Ratings

Symbol	Parameter	Ratings	Unit
$I_D$	Continuous Drain Current @ $T_C = 25^\circ C$	30	A
	Continuous Drain Current @ $T_C = 100^\circ C$	19	
$I_{DM}$	Pulsed Drain Current <sup>①</sup>	120	
$V_{GS}$	Gate-Source Voltage	$\pm 30$	V
$E_{AS}$	Single Pulse Avalanche Energy <sup>②</sup>	1875	mJ
$I_{AR}$	Avalanche Current, Repetitive or Non-Repetitive	16	A

### Thermal and Mechanical Characteristics

Symbol	Characteristic	Min	Typ	Max	Unit
$P_D$	Total Power Dissipation @ $T_C = 25^\circ C$			1040	W
$R_{\theta JC}$	Junction to Case Thermal Resistance			0.12	$^\circ C/W$
$R_{\theta CS}$	Case to Sink Thermal Resistance, Flat, Greased Surface		0.11		
$T_J, T_{STG}$	Operating and Storage Junction Temperature Range	-55		150	$^\circ C$
$T_L$	Soldering Temperature for 10 Seconds (1.6mm from case)			300	
$W_T$	Package Weight		0.22		oz
			6.2		g
Torque	Mounting Torque ( TO-264 Package), 4-40 or M3 screw			10	in·lbf
				1.1	N·m

**Static Characteristics**
**T<sub>J</sub> = 25°C unless otherwise specified**
**APT29F100B2\_L**

Symbol	Parameter	Test Conditions	Min	Typ	Max	Unit
V <sub>BR(DSS)</sub>	Drain-Source Breakdown Voltage	V <sub>GS</sub> = 0V, I <sub>D</sub> = 250μA	1000			V
ΔV <sub>BR(DSS)}/ΔT<sub>J</sub></sub>	Breakdown Voltage Temperature Coefficient	Reference to 25°C, I <sub>D</sub> = 250μA		1.15		V/°C
R <sub>DS(on)</sub>	Drain-Source On Resistance <sup>③</sup>	V <sub>GS</sub> = 10V, I <sub>D</sub> = 16A		0.37	0.44	Ω
V <sub>GS(th)</sub>	Gate-Source Threshold Voltage	V <sub>GS</sub> = V <sub>DS</sub> , I <sub>D</sub> = 2.5mA	2.5	4	5	V
ΔV <sub>GS(th)}/ΔT<sub>J</sub></sub>	Threshold Voltage Temperature Coefficient			-10		mV/°C
I <sub>DSS</sub>	Zero Gate Voltage Drain Current	V <sub>DS</sub> = 1000V V <sub>GS</sub> = 0V			250 1000	μA
I <sub>GSS</sub>	Gate-Source Leakage Current	V <sub>GS</sub> = ±30V			±100	nA

**Dynamic Characteristics**
**T<sub>J</sub> = 25°C unless otherwise specified**

Symbol	Parameter	Test Conditions	Min	Typ	Max	Unit
g <sub>fs</sub>	Forward Transconductance	V <sub>DS</sub> = 50V, I <sub>D</sub> = 16A		34		S
C <sub>iss</sub>	Input Capacitance	V <sub>GS</sub> = 0V, V <sub>DS</sub> = 25V f = 1MHz		8500		pF
C <sub>rss</sub>	Reverse Transfer Capacitance			115		
C <sub>oss</sub>	Output Capacitance			715		
C <sub>o(cr)</sub> <sup>④</sup>	Effective Output Capacitance, Charge Related	V <sub>GS</sub> = 0V, V <sub>DS</sub> = 0V to 667V		290		pF
C <sub>o(er)</sub> <sup>⑤</sup>	Effective Output Capacitance, Energy Related			150		
Q <sub>g</sub>	Total Gate Charge	V <sub>GS</sub> = 0 to 10V, I <sub>D</sub> = 16A, V <sub>DS</sub> = 500V		260		nC
Q <sub>gs</sub>	Gate-Source Charge			46		
Q <sub>gd</sub>	Gate-Drain Charge			125		
t <sub>d(on)</sub>	Turn-On Delay Time	<b>Resistive Switching</b> V <sub>DD</sub> = 667V, I <sub>D</sub> = 16A R <sub>G</sub> = 2.2Ω <sup>⑥</sup> , V <sub>GG</sub> = 15V		39		ns
t <sub>r</sub>	Current Rise Time			35		
t <sub>d(off)</sub>	Turn-Off Delay Time			130		
t <sub>f</sub>	Current Fall Time			33		

**Source-Drain Diode Characteristics**

Symbol	Parameter	Test Conditions	Min	Typ	Max	Unit
I <sub>S</sub>	Continuous Source Current (Body Diode)	MOSFET symbol showing the integral reverse p-n junction diode (body diode)			30	A
I <sub>SM</sub>	Pulsed Source Current (Body Diode) <sup>①</sup>				120	
V <sub>SD</sub>	Diode Forward Voltage	I <sub>SD</sub> = 16A, T <sub>J</sub> = 25°C, V <sub>GS</sub> = 0V			1.2	V
t <sub>rr</sub>	Reverse Recovery Time	I <sub>SD</sub> = 16A <sup>③</sup> di <sub>SD</sub> /dt = 100A/μs	T <sub>J</sub> = 25°C	230	270	ns
Q <sub>rr</sub>	Reverse Recovery Charge		T <sub>J</sub> = 125°C	500	640	
			T <sub>J</sub> = 25°C	13		μC
I <sub>rrm</sub>	Reverse Recovery Current		T <sub>J</sub> = 125°C	35		
			T <sub>J</sub> = 25°C	11		A
T <sub>J</sub> = 125°C	15					
dv/dt	Peak Recovery dv/dt	I <sub>SD</sub> ≤ 16A, di/dt ≤ 1000A/μs, V <sub>DD</sub> = 667V, T <sub>J</sub> = 125°C			25	V/ns

① Repetitive Rating: Pulse width and case temperature limited by maximum junction temperature.

② Starting at T<sub>J</sub> = 25°C, L = 14.65mH, R<sub>G</sub> = 25Ω, I<sub>AS</sub> = 16A.

③ Pulse test: Pulse Width < 380μs, duty cycle < 2%.

④ C<sub>o(cr)</sub> is defined as a fixed capacitance with the same stored charge as C<sub>oss</sub> with V<sub>DS</sub> = 67% of V<sub>(BR)DSS</sub>.

⑤ C<sub>o(er)</sub> is defined as a fixed capacitance with the same stored energy as C<sub>oss</sub> with V<sub>DS</sub> = 67% of V<sub>(BR)DSS</sub>. To calculate C<sub>o(er)</sub> for any value of V<sub>DS</sub> less than V<sub>(BR)DSS</sub>, use this equation: C<sub>o(er)</sub> = -2.47E-7/V<sub>DS</sub><sup>2</sup> + 4.36E-8/V<sub>DS</sub> + 8.44E-11.

⑥ R<sub>G</sub> is external gate resistance, not including internal gate resistance or gate driver impedance. (MIC4452)

Microsemi reserves the right to change, without notice, the specifications and information contained herein.

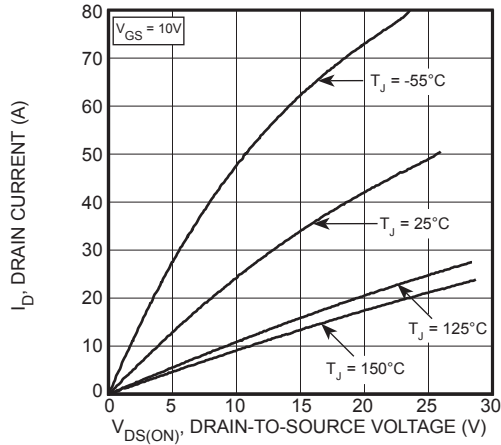

Figure 1, Output Characteristics

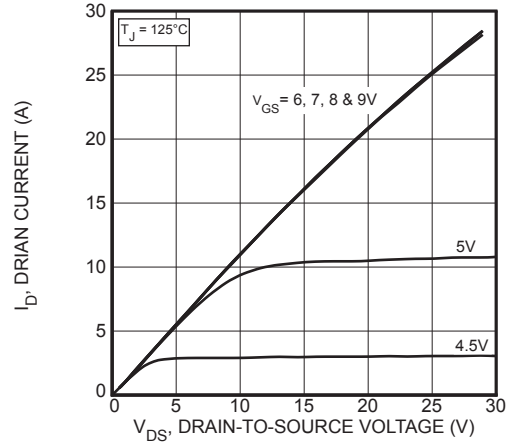

Figure 2, Output Characteristics

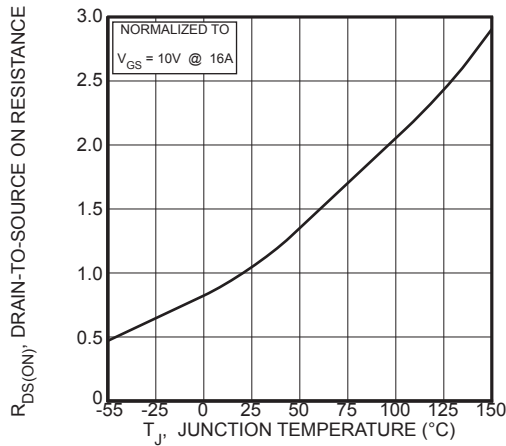

Figure 3,  $R_{DS(ON)}$  vs Junction Temperature

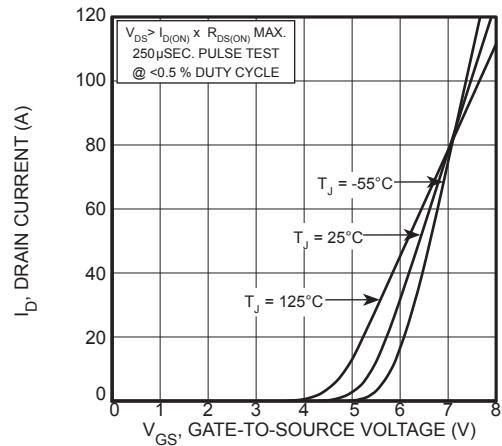

Figure 4, Transfer Characteristics

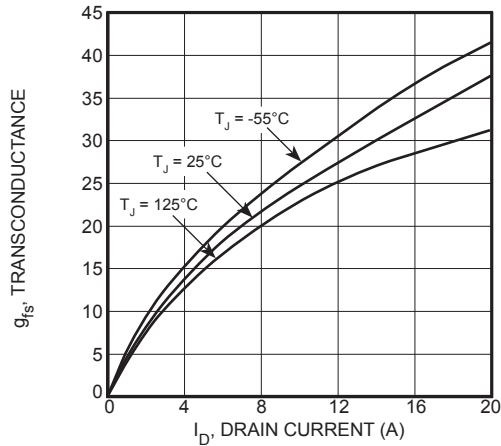

Figure 5, Gain vs Drain Current

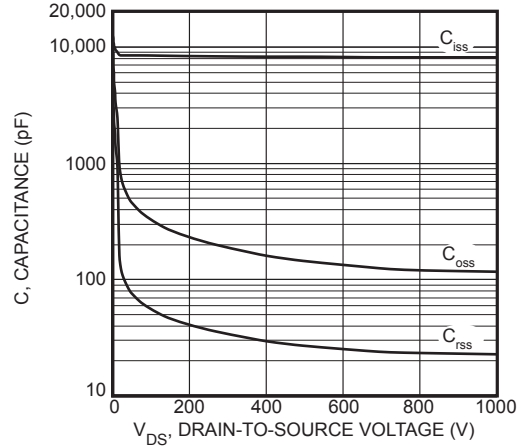

Figure 6, Capacitance vs Drain-to-Source Voltage

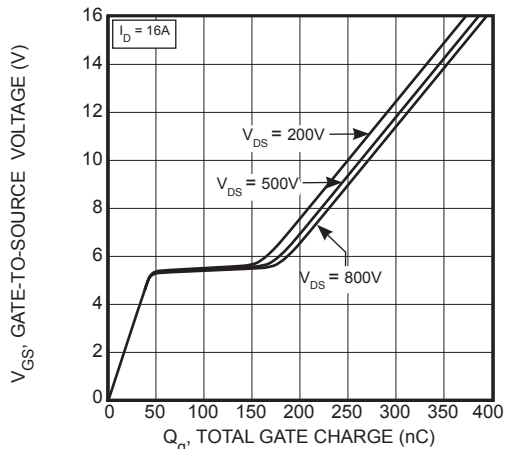

Figure 7, Gate Charge vs Gate-to-Source Voltage

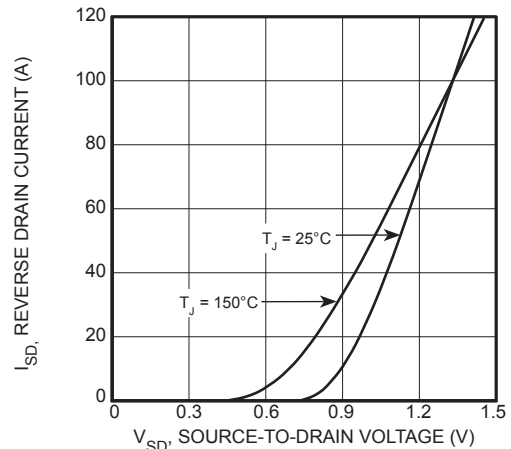
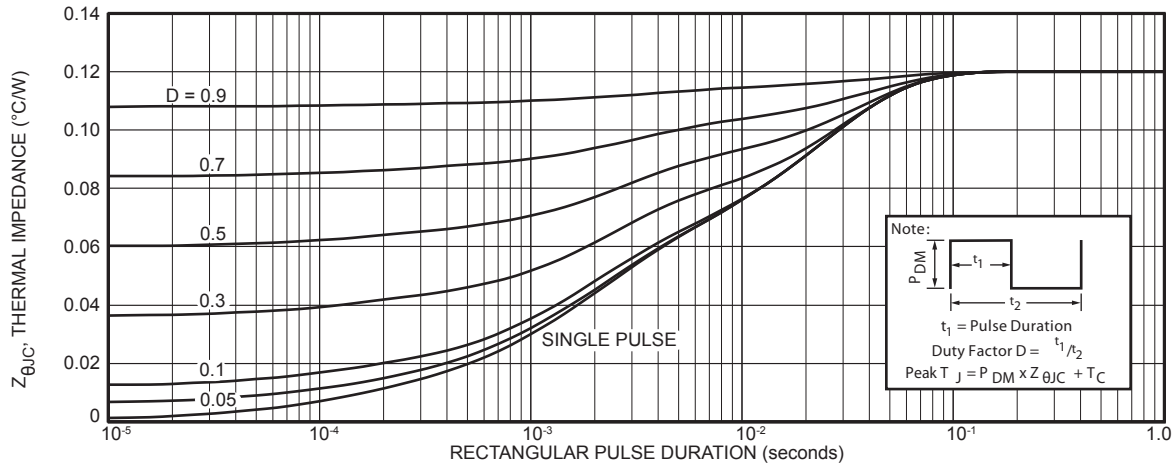
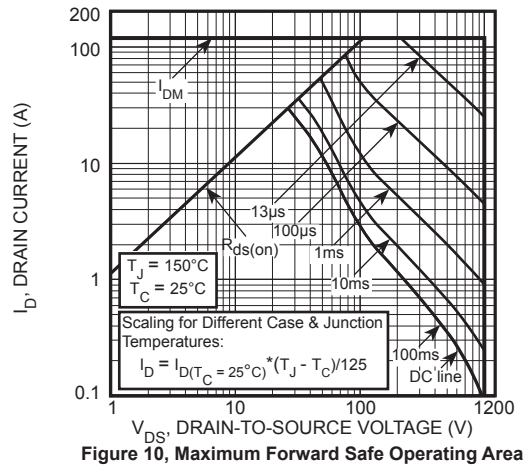
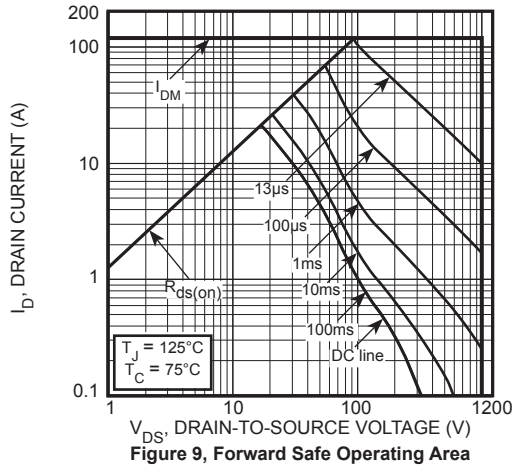
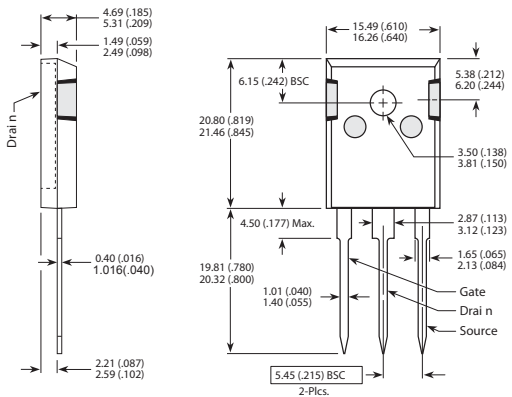

Figure 8, Reverse Drain Current vs Source-to-Drain Voltage



**TO-247 (B) Package Outline**

Ⓛ SAC: Tin, Silver, Copper



Dimensions in Millimeters (Inches)

**D<sup>3</sup>PAK Package Outline**

Ⓛ 100% Sn Plated

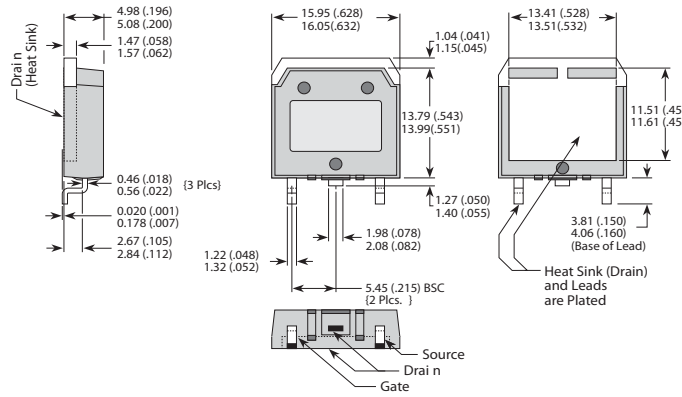

Dimensions in Millimeters (Inches)

## Looking for pricing, stock, or lifecycle information?

Click below to explore more details on WIN SOURCE:

- ⊖ [View APT29F100L on WIN SOURCE](#)
- ⊖ [Microsemi Corporation Information](#)

## Optimize Your Supply Chain with WIN SOURCE Solutions

- ✓ Global Sourcing Solution
- ✓ Obsolete Management
- ✓ Cost Control Management
- ✓ Shortage Management
- ✓ Alternative Solution
- ✓ Excess Inventory Management