



**THE DATASHEET OF**  
**AP2166SG-13**



## Description

The AP2166 and AP2176 are integrated high-side power switches optimized for Universal Serial Bus (USB) and other hot-swap applications. The family of devices complies with USB 2.0 and available with both polarities of Enable input. They offer current and thermal limiting and short-circuit protection as well as controlled rise time and under-voltage lockout functionality. A 7ms deglitch capability on the open-drain Flag output prevents false overcurrent reporting and does not require any external components.

All devices are available in SO-8 and MSOP-8EP packages.

## Features

- Dual USB port power switches
- Overcurrent and thermal protection
- 1.5A accurate current limiting
- Reverse Current Blocking
- 90mΩ on-resistance
- Input voltage range: 2.7V - 5.5V
- 0.6ms typical rise time
- Very low shutdown current: 1μA (max)
- Fault report (FLG) with blanking time (7ms typ)
- ESD protection: 6KV HBM, 300V MM
- Active low (AP2166) or active high (AP2176) enable
- Ambient temperature range -40°C to +85°C
- SO-8 and MSOP-8EP (Exposed Pad): Available in "Green" Molding Compound (No Br, Sb)
- UL Recognized, File Number E322375
- IEC60950-1 CB Scheme Certified
- **Totally Lead-Free & Fully RoHS Compliant (Notes 1 & 2)**
- **Halogen and Antimony Free. "Green" Device (Note 3)**

- Notes:
1. No purposely added lead. Fully EU Directive 2002/95/EC (RoHS) & 2011/65/EU (RoHS 2) compliant.
  2. See [http://www.diodes.com/quality/lead\\_free.html](http://www.diodes.com/quality/lead_free.html) for more information about Diodes Incorporated's definitions of Halogen- and Antimony-free, "Green" and Lead-free.
  3. Halogen- and Antimony-free "Green" products are defined as those which contain <900ppm bromine, <900ppm chlorine (<1500ppm total Br + Cl) and <1000ppm antimony compounds.

## Pin Assignments

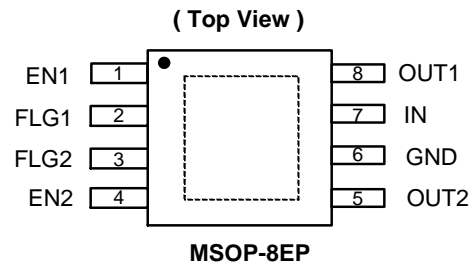
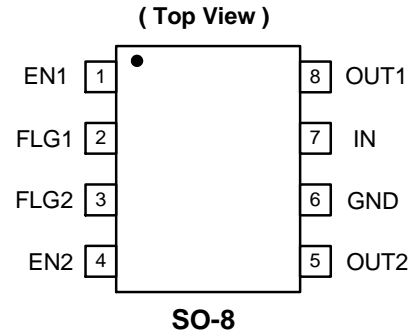

## Applications

- Consumer Electronics – LCD TVs & Monitors, Game Machines
- Communications – Set-Top-Boxes, GPS, Smartphones
- Computing – Laptops, Desktops, Servers, Printers, Docking Stations, HUBs

## Typical Applications Circuit

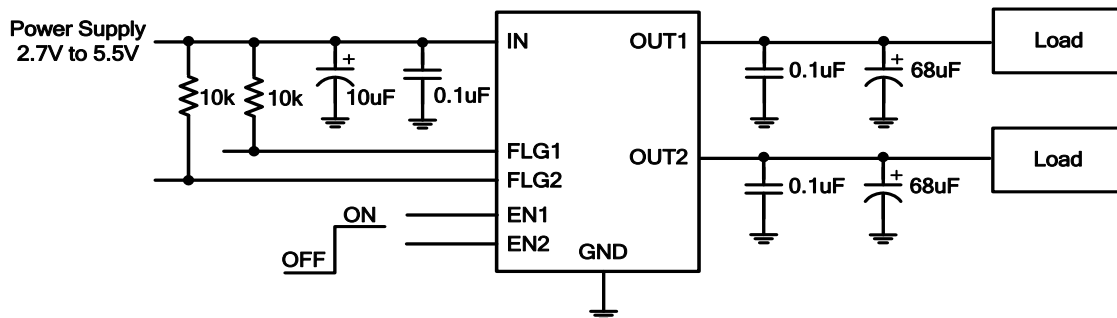

Available Options

Part Number	Channel	Enable Pin (EN)	Current Limit (typ)	Recommended Maximum Continuous Load Current
AP2166	2	Active Low	1.5A	1.0A
AP2176	2	Active High	1.5A	1.0A

Pin Descriptions

Pin Name	Pin Number		Function
	SO-8	MSOP-8EP	
EN1	1	1	Switch 1 enable input, active low (AP2166) or active high (AP2176)
FLG1	2	2	Switch 1 over-current and over-temperature fault report, open-drain
FLG2	3	3	Switch 2 over-current and over-temperature fault report, open-drain
EN2	4	4	Switch 2 enable input, active low (AP2166) or active high (AP2176)
OUT2	5	5	Switch 2 voltage output pin
GND	6	6	Ground
IN	7	7	Voltage input pin
OUT1	8	8	Switch 1 voltage output pin
Exposed Pad	—	Exposed Pad	Exposed Pad: It should be connected externally to GND and thermal mass for enhanced thermal impedance. It should not be used as electrical ground conduction path.

Functional Block Diagram

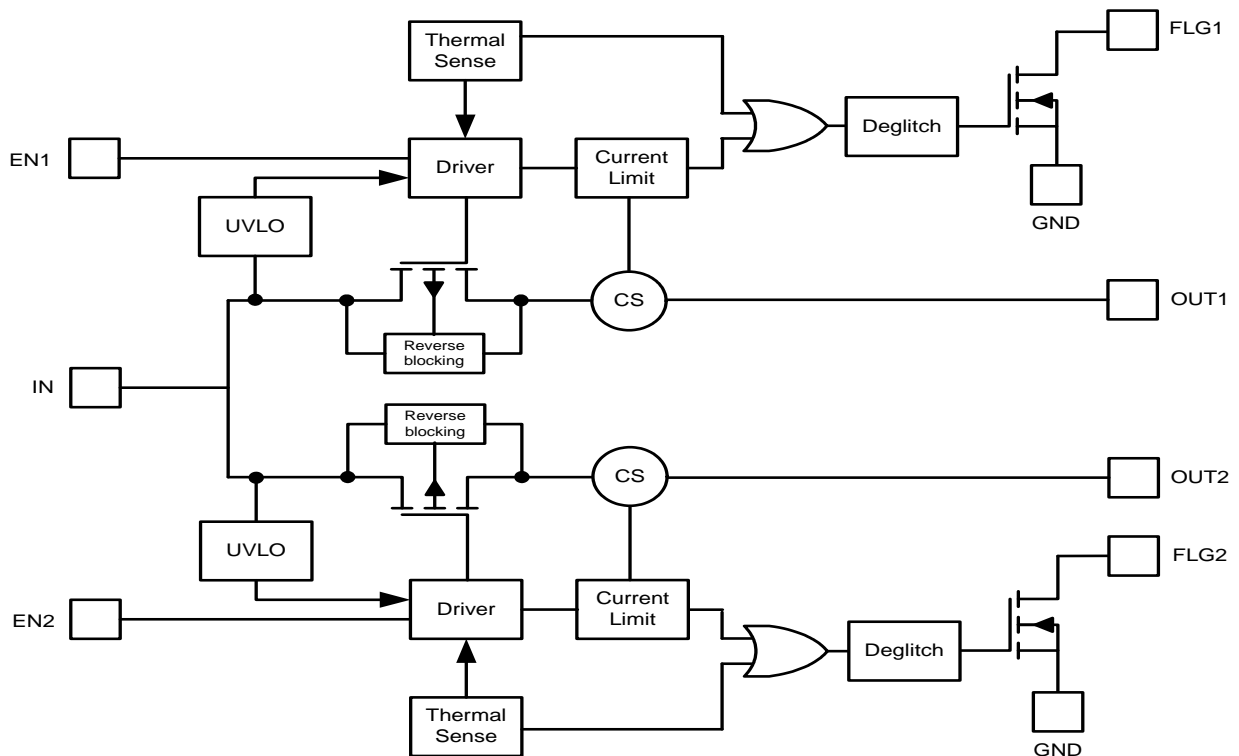

**Absolute Maximum Ratings** (@T<sub>A</sub> = +25°C, unless otherwise specified.)

Symbol	Parameter	Rating	Unit
ESD HBM	Human Body Model ESD Protection	6	kV
ESD MM	Machine Model ESD Protection	300	V
V <sub>IN</sub>	Input Voltage	6.5	V
V <sub>OUT</sub>	Output Voltage	V <sub>IN</sub> +0.3	V
V <sub>EN</sub> , V <sub>FLG</sub>	Enable Voltage	6.5	V
I <sub>LOAD</sub>	Maximum Continuous Load Current	Internal Limited	A
T <sub>J(MAX)</sub>	Maximum Junction Temperature	+150	°C
T <sub>ST</sub>	Storage Temperature Range (Note 4)	-65 to +150	°C

Note: 4. UL Recognized Rating from -30°C to +70°C (Diodes qualified T<sub>ST</sub> from -65°C to +150°C).

**Recommended Operating Conditions** (@T<sub>A</sub> = +25°C, unless otherwise specified.)

Symbol	Parameter	Min	Max	Units
V <sub>IN</sub>	Input Voltage	2.7	5.5	V
I <sub>OUT</sub>	Output Current	0	1.0	A
V <sub>IL</sub>	Low-Level Input Voltage on EN or $\overline{EN}$	0	0.8	V
V <sub>IH</sub>	High-Level Input Voltage on EN or $\overline{EN}$	2	V <sub>IN</sub>	V
T <sub>A</sub>	Operating Ambient Temperature	-40	+85	°C

### Electrical Characteristics (@T<sub>A</sub> = +25°C, C<sub>IN</sub> = 10μF, V<sub>IN</sub> = +5V, unless otherwise specified.)

Symbol	Parameter	Test Conditions	Min	Typ	Max	Unit
V <sub>UVLO</sub>	Input UVLO	R <sub>LOAD</sub> = 1kΩ	1.6	1.9	2.5	V
I <sub>SHDN</sub>	Input Shutdown Current	Disabled, I <sub>OUT</sub> = 0	-	0.5	1	μA
I <sub>Q</sub>	Input Quiescent Current, Dual	Enabled, I <sub>OUT</sub> = 0	-	95	140	μA
I <sub>LEAK</sub>	Input Leakage Current	Disabled, O <sub>UT</sub> grounded	-	-	1	μA
I <sub>REV</sub>	Reverse Leakage Current	Disabled, V <sub>IN</sub> = 0V, V <sub>OUT</sub> = 5V, I <sub>REV</sub> at V <sub>IN</sub>	-	1	-	μA
R <sub>DS(ON)</sub>	Switch On-Resistance	V <sub>IN</sub> = 5V, I <sub>OUT</sub> = 1A, -40°C ≤ T <sub>A</sub> ≤ +85°C	-	90	135	mΩ
		MSOP-8EP				
		SO-8	-	100	135	mΩ
		V <sub>IN</sub> = 3.3V, I <sub>OUT</sub> = 1A, -40°C ≤ T <sub>A</sub> ≤ +85°C	-	120	160	mΩ
I <sub>SHORT</sub>	Short-Circuit Current Limit	Enabled into short circuit, C <sub>L</sub> = 68μF	-	1.5	-	A
I <sub>LIMIT</sub>	Overload Current Limit	V <sub>IN</sub> = 5V, V <sub>OUT</sub> = 4.8V, C <sub>L</sub> = 120μF, -40°C ≤ T <sub>A</sub> ≤ +85°C	1.1	1.5	1.9	A
I <sub>Trig</sub>	Current Limiting Trigger Threshold	V <sub>IN</sub> = V <sub>EN</sub> , Output Current Slew rate (<100A/WS), C <sub>L</sub> = 68μF	-	2.0	-	A
T <sub>SHORT</sub>	Short-Circuit Response Time	V <sub>OUT</sub> = 0V to I <sub>OUT</sub> = I <sub>LIMIT</sub> (short applied to output), C <sub>L</sub> = 68μF	-	20	-	μs
V <sub>IL</sub>	EN Input Logic Low Voltage	V <sub>IN</sub> = 2.7V to 5.5V	-	-	0.8	V
V <sub>IH</sub>	EN Input Logic High Voltage	V <sub>IN</sub> = 2.7V to 5.5V	2	-	-	V
I <sub>SINK</sub>	EN Input Leakage	V <sub>EN</sub> = 5V	-	-	1	μA
T <sub>D(ON)</sub>	Output Turn-on Delay Time	C <sub>L</sub> = 1μF, R <sub>LOAD</sub> = 10Ω	-	0.05	-	ms
T <sub>R</sub>	Output Turn-on Rise Time	C <sub>L</sub> = 1μF, R <sub>LOAD</sub> = 10Ω	-	0.6	1.5	ms
T <sub>D(OFF)</sub>	Output Turn-off Delay Time	C <sub>L</sub> = 1μF, R <sub>LOAD</sub> = 10Ω	-	0.01	-	ms
T <sub>F</sub>	Output Turn-off Fall Time	C <sub>L</sub> = 1μF, R <sub>LOAD</sub> = 10Ω	-	0.05	0.1	ms
R <sub>FLG</sub>	FLG Output FET on-Resistance	I <sub>FLG</sub> = 10mA	-	20	40	Ω
I <sub>FOH</sub>	Error Flag I <sub>ff</sub> Current	V <sub>FLG</sub> = 5V	-	0.01	1	μA
T <sub>Blank</sub>	FLG Blanking Time	C <sub>L</sub> = 68μF	4	7	15	ms
T <sub>SHDN</sub>	Thermal Shutdown Threshold	Enabled, R <sub>LOAD</sub> = 1kΩ	-	+140	-	°C
T <sub>HYS</sub>	Thermal Shutdown Hysteresis	-	-	+25	-	°C
θ <sub>JA</sub>	Thermal Resistance Junction-to-Ambient	SO-8 (Note 5)	-	110	-	°C/W
		MSOP-8EP (Note 6)	-	60	-	°C/W

- Notes:
5. Test condition for SO-8: Device mounted on FR-4 2-layer board, 2oz. copper, with minimum recommended pad layout.
  6. Test condition for MSOP-8EP: Device mounted on FR-4 2-layer board, 2oz. copper, with minimum recommended pad on top layer and 3 vias to bottom layer ground plane.

**Typical Performance Characteristics**

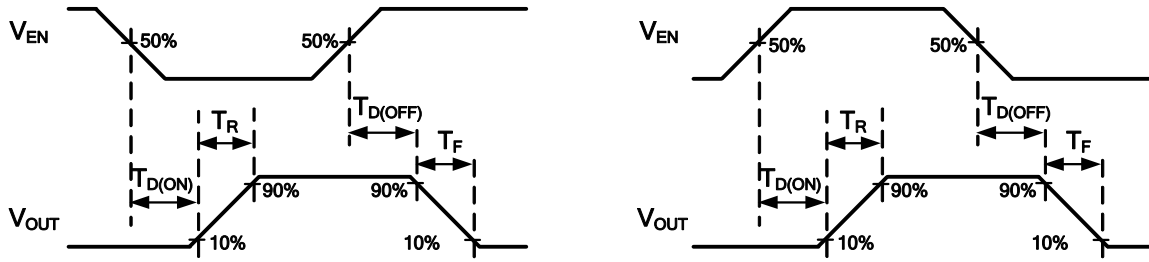
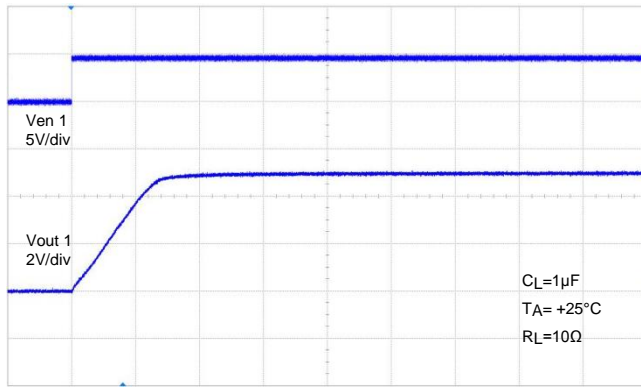
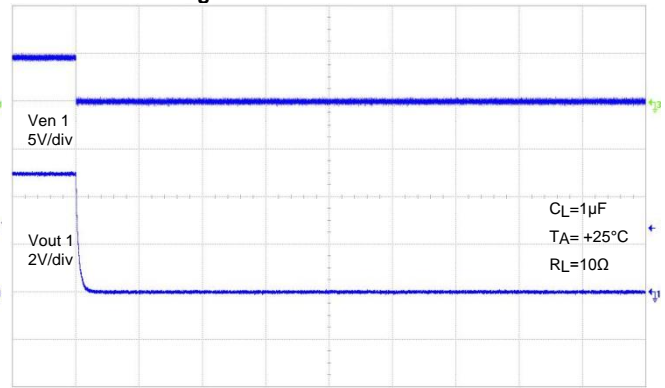

Figure 1 Voltage Waveforms: AP2166 (left), AP2176 (right)

All Enable Plots are for AP2176 Active High



500µs/div  
Channel 1 Turn-On Delay and Rise Time



500µs/div  
Channel 1 Turn-Off Delay and Fall Time

$C_L=1\mu F$   
 $T_A=+25^\circ C$   
 $R_L=10\Omega$

$C_L=1\mu F$   
 $T_A=+25^\circ C$   
 $R_L=10\Omega$

**Typical Performance Characteristics** (continued)

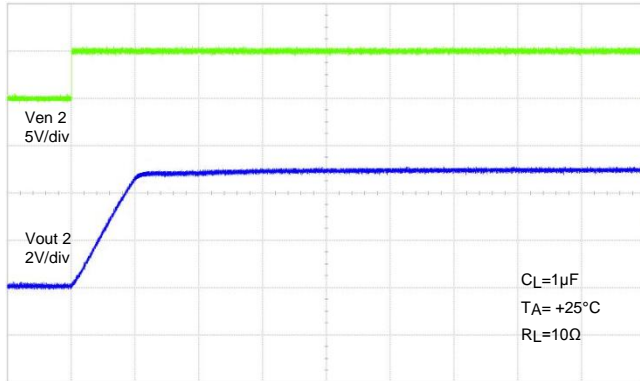

500µs/div  
**Channel 2 Turn-On Delay and Rise Time**

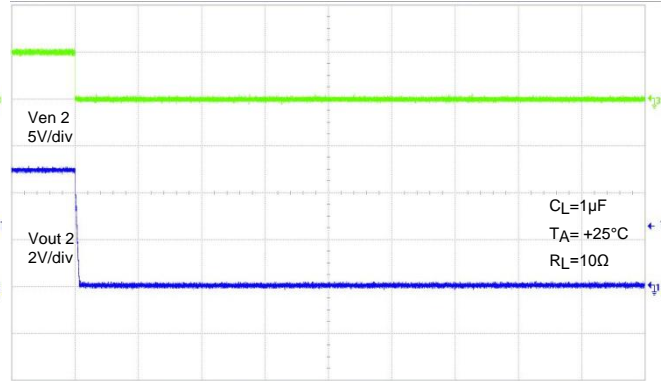

500µs/div  
**Channel 2 Turn-Off Delay and Fall Time**

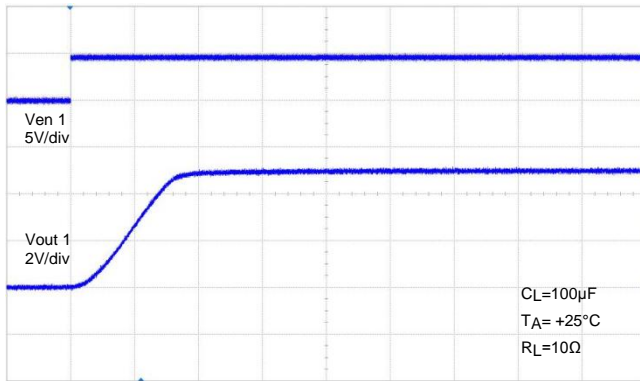

500µs/div  
**Channel 1 Turn-On Delay and Rise Time**

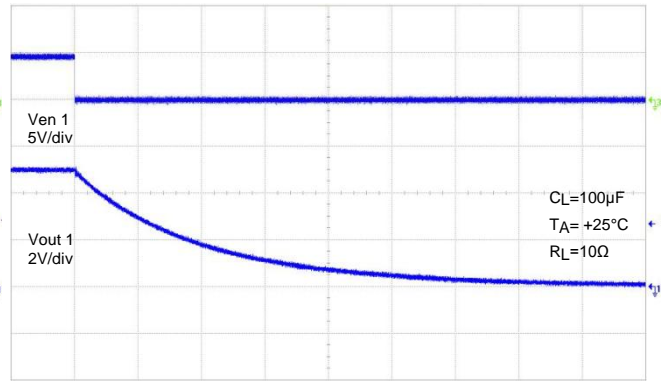

500µs/div  
**Channel 1 Turn-Off Delay and Fall Time**

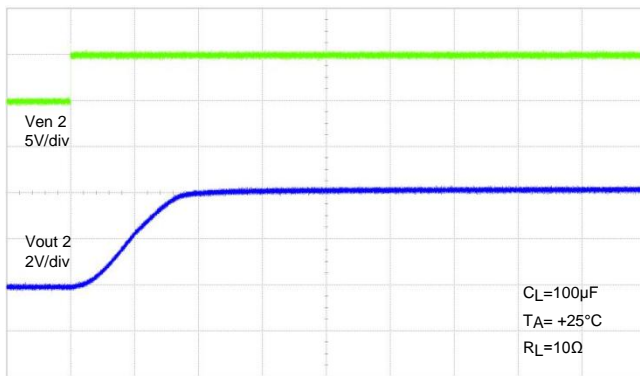

500µs/div  
**Channel 2 Turn-On Delay and Rise Time**

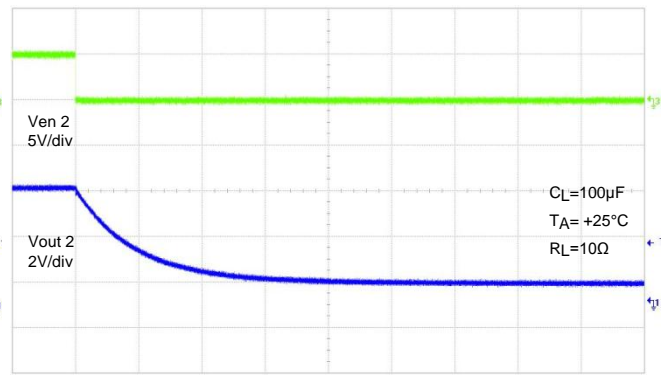

500µs/div  
**Channel 2 Turn-Off Delay and Fall Time**

**Typical Performance Characteristics** (cont.)

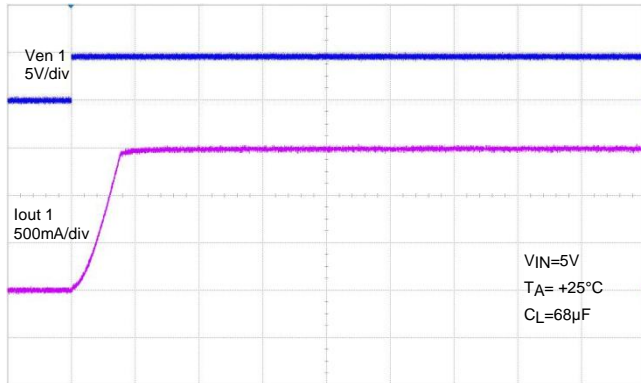

500µs/div  
Channel 1 Short Circuit Current,  
Device Enabled Into Short

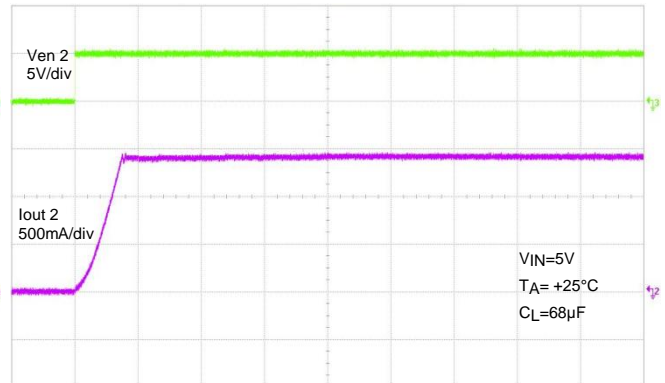

500µs/div  
Channel 2 Short Circuit Current,  
Device Enabled Into Short

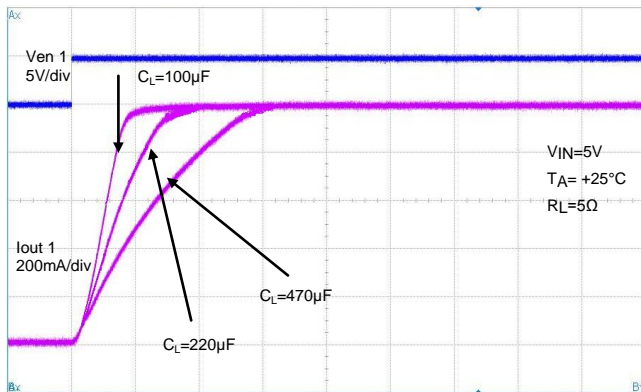

1ms/div  
Channel 1 Inrush Current

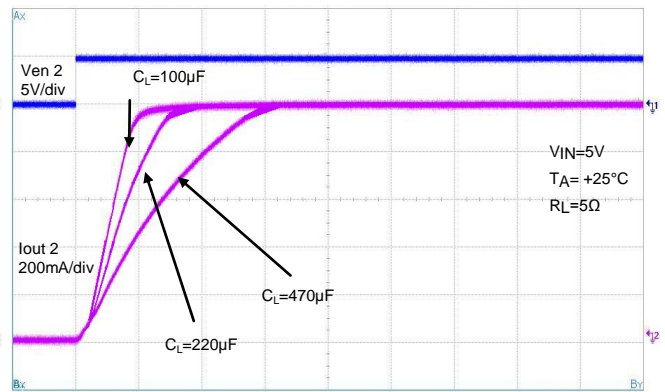

1ms/div  
Channel 2 Inrush Current

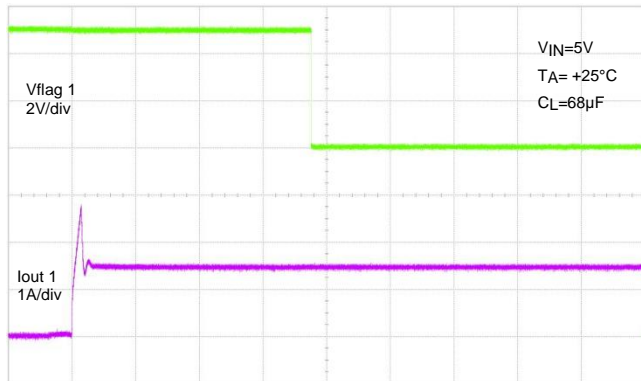

2ms/div  
Channel 1  
1Ω Load Connected to Enabled Device

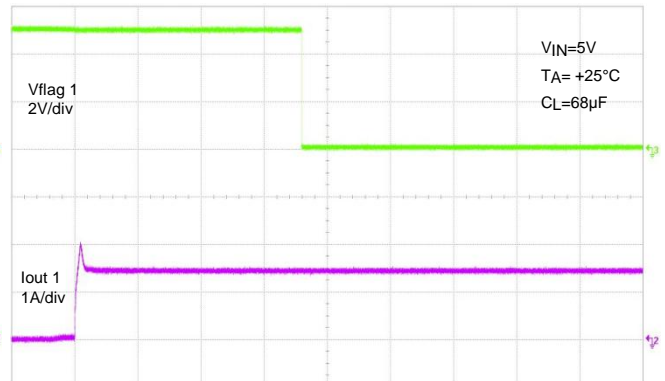

2ms/div  
Channel 1  
2Ω Load Connected to Enabled Device

**Typical Performance Characteristics (cont.)**

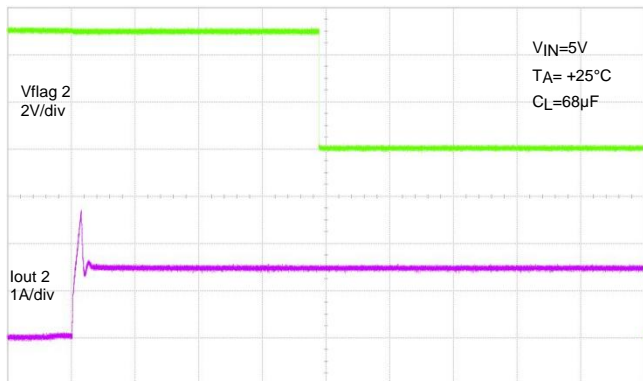

**2ms/div  
Channel 2  
1Ω Load Connected to Enabled Device**

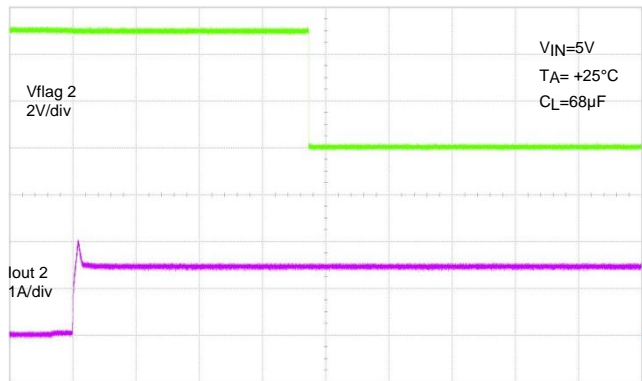

**2ms/div  
Channel 2  
2Ω Load Connected to Enabled Device**

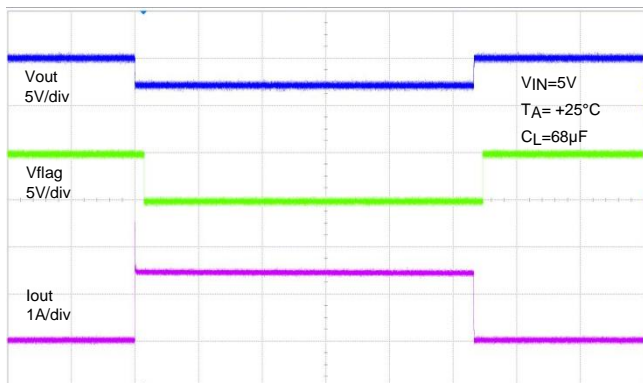

**20ms/div  
Channel 1  
Short Circuit with Blanking Time and Recovery**

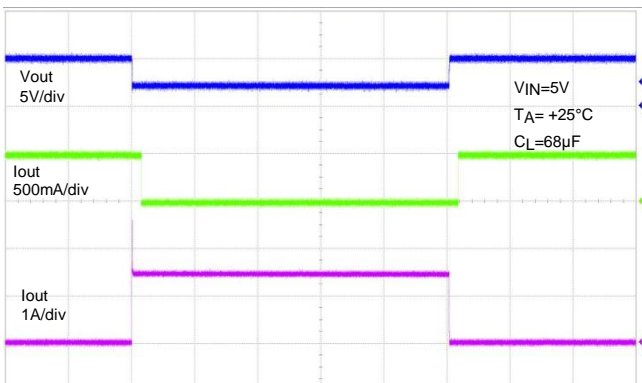

**20ms/div  
Channel 2  
Short Circuit with Blanking Time and Recovery**

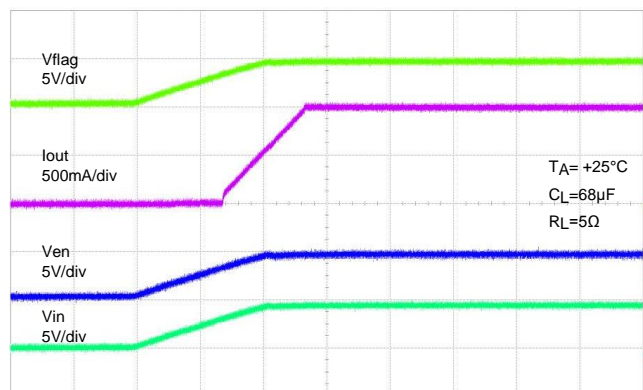

**1ms/div  
Channel 1 Power On**

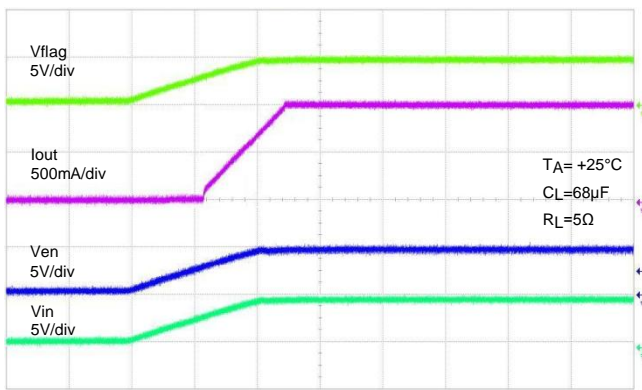

**1ms/div  
Channel 2 Power On**

**Typical Performance Characteristics (cont.)**

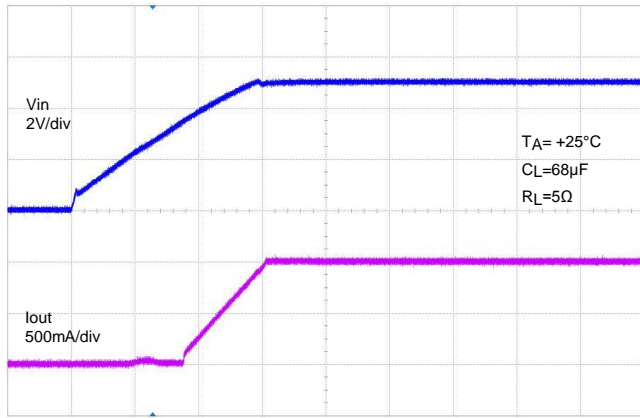

1ms/div  
Channel 1 UVLO Increasing

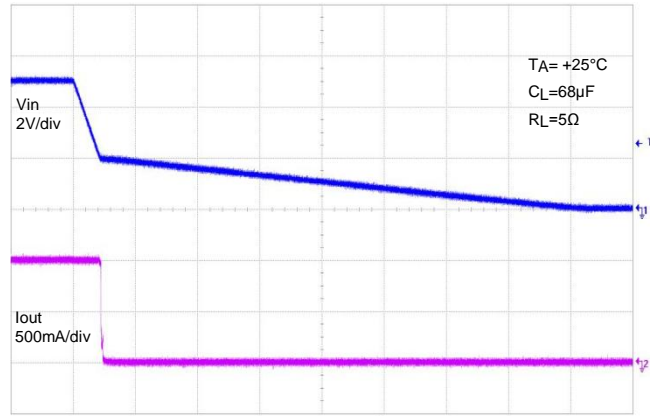

10ms/div  
Channel 1 UVLO Decreasing

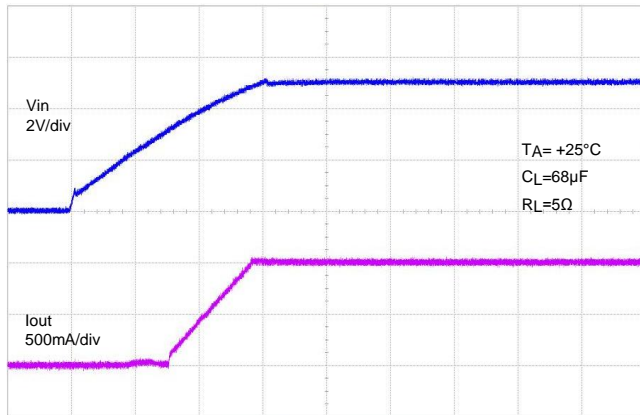

1ms/div  
Channel 2 UVLO Increasing

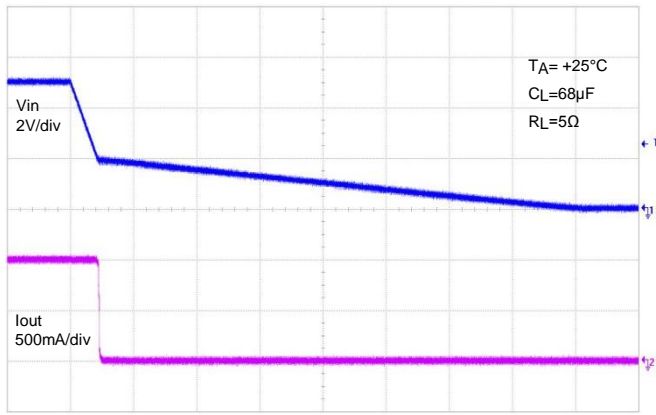

10ms/div  
Channel 2 UVLO Decreasing

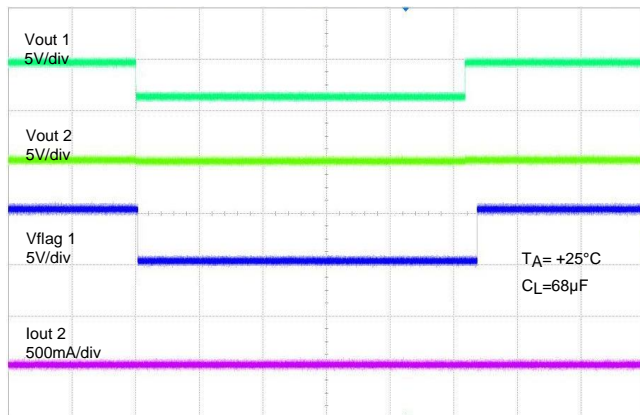

100ms/div  
Channel 1 Enabled and Shorted with Channel 2 Disabled

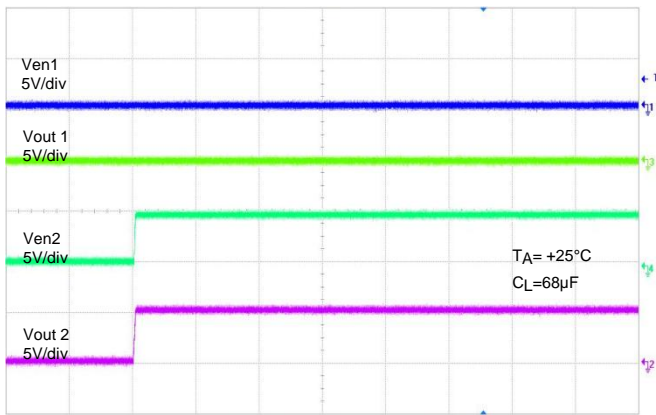

50ms/div  
Channel 1 Disabled and Channel 2 Enabled

**Typical Performance Characteristics** (cont.)

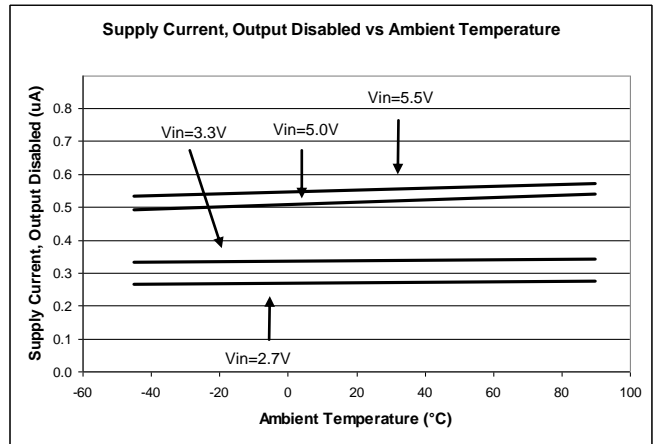
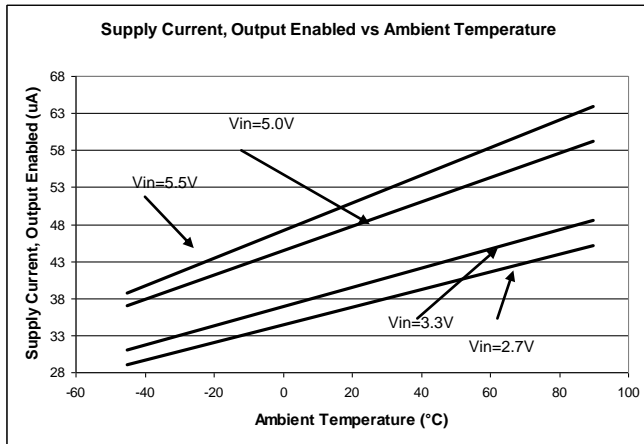
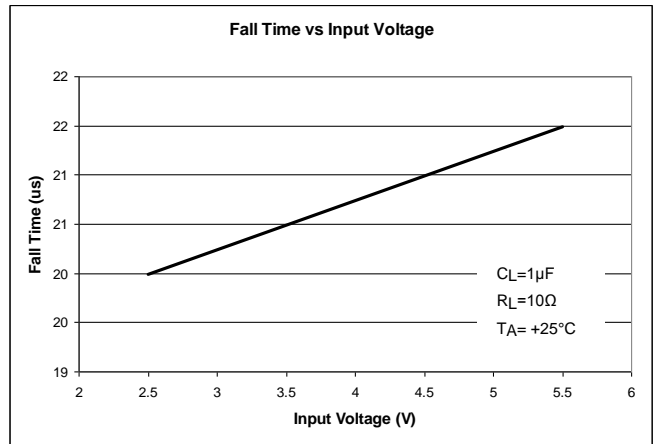
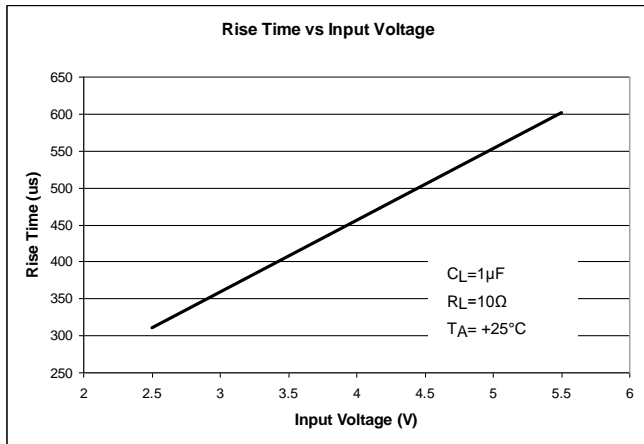
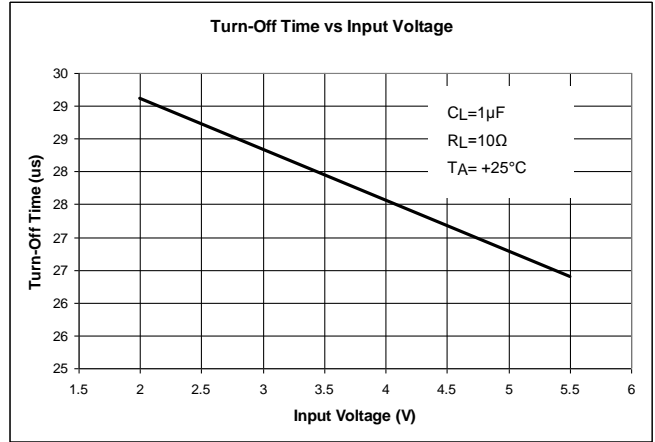
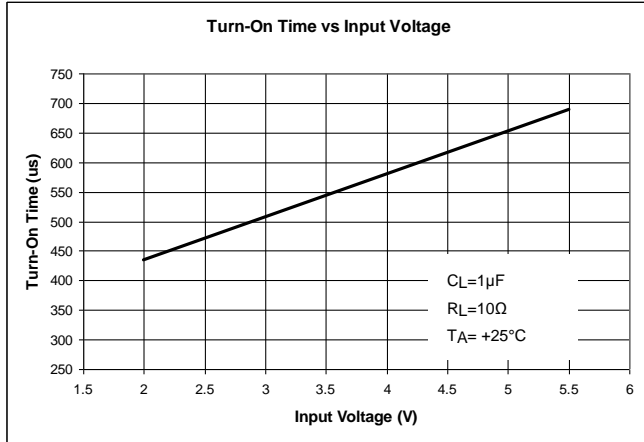

**Typical Performance Characteristics** (cont.)

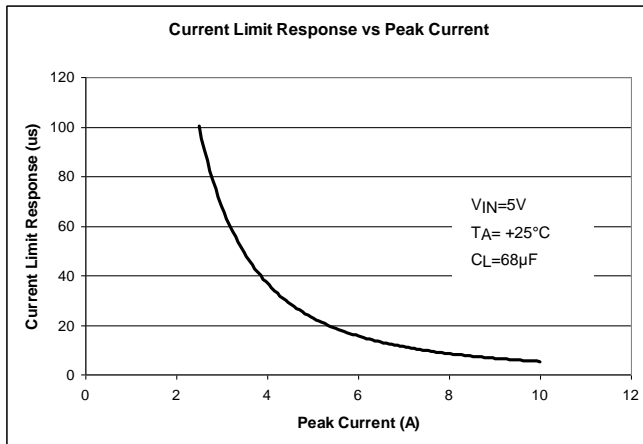
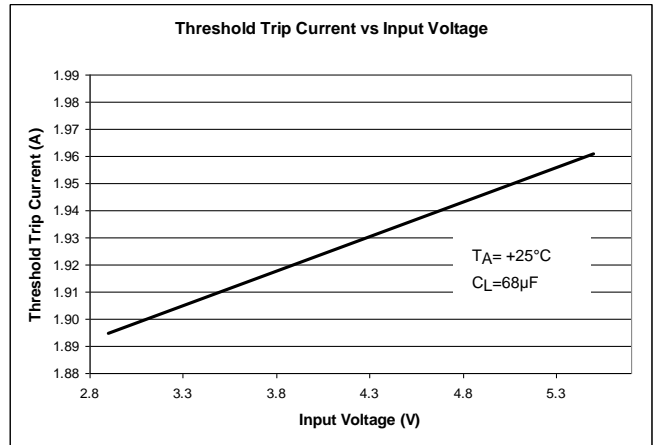
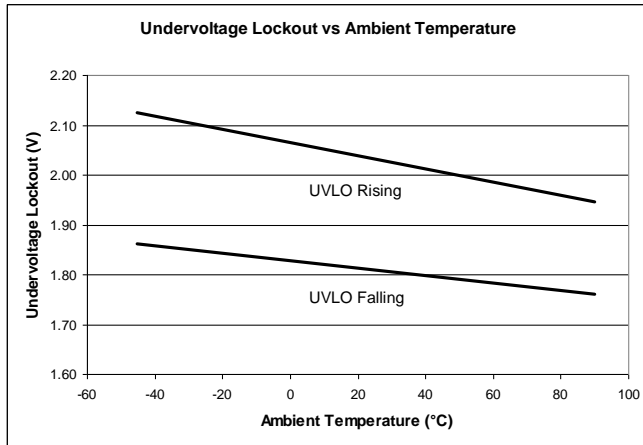
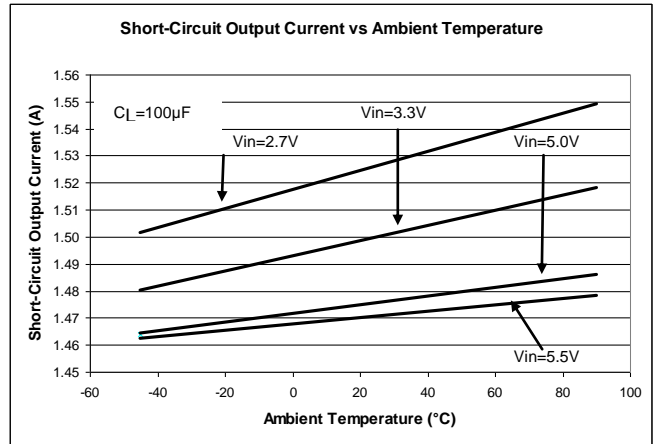
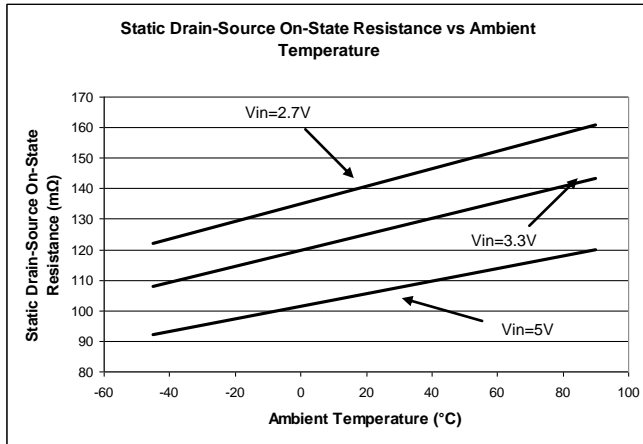

## Application Information

### Power Supply Considerations

A 0.01- $\mu$ F to 0.1- $\mu$ F X7R or X5R ceramic bypass capacitor between IN and GND, close to the device, is recommended. Placing a high-value electrolytic capacitor on the input (10- $\mu$ F minimum) and output pin(s) is recommended when the output load is heavy. This precaution reduces power-supply transients that may cause ringing on the input. Additionally, bypassing the output with a 0.01- $\mu$ F to 0.1- $\mu$ F ceramic capacitor improves the immunity of the device to short-circuit transients.

### Overcurrent and Short Circuit Protection

An internal sensing FET is employed to check for over-current conditions. Unlike current-sense resistors, sense FETs do not increase the series resistance of the current path. When an overcurrent condition is detected, the device maintains a constant output current and reduces the output voltage accordingly. Complete shutdown occurs only if the fault stays long enough to activate thermal limiting.

Three possible overload conditions can occur. In the first condition, the output has been shorted to GND before the device is enabled or before  $V_{IN}$  has been applied. The AP2166/AP2176 senses the short circuit and immediately clamps output current to a certain safe level namely  $I_{LIMIT}$ .

In the second condition, an output short or an overload occurs while the device is enabled. At the instance the overload occurs, higher current may flow for a very short period of time before the current limit function can react. After the current limit function has tripped (reached the overcurrent trip threshold), the device switches into current limiting mode and the current is clamped at  $I_{LIMIT}$ .

In the third condition, the load has been gradually increased beyond the recommended operating current. The current is permitted to rise until the current-limit threshold ( $I_{TRIP}$ ) is reached or until the thermal limit of the device is exceeded. The AP2166/AP2176 is capable of delivering current up to the current-limit threshold without damaging the device. Once the threshold has been reached, the device switches into its current limiting mode and is set at  $I_{LIMIT}$ .

Note that when the output has been shorted to GND at extremely low temperature ( $< -30^{\circ}\text{C}$ ), a minimum 120- $\mu$ F electrolytic capacitor on the output pin is recommended. A correct capacitor type with capacitor voltage rating and temperature characteristics must be properly chosen so that capacitance value does not drop too low at the extremely low temperature operation. A recommended capacitor should have temperature characteristics of less than 10% variation of capacitance change when operated at extremely low temp. Our recommended aluminum electrolytic capacitor type is Panasonic FC series.

### FLG Response

When an overcurrent or over-temperature shutdown condition is encountered, the FLG open-drain output goes active low after a nominal 7-ms deglitch timeout. The FLG output remains low until both overcurrent and over-temperature conditions are removed. Connecting a heavy capacitive load to the output of the device can cause a momentary overcurrent condition, which does not trigger the FLG due to the 7-ms deglitch timeout. The AP2166/AP2176 is designed to eliminate false overcurrent reporting without the need of external components to remove unwanted pulses.

### Power Dissipation and Junction Temperature

The low on-resistance of the internal MOSFET allows the small surface-mount packages to pass large current. Using the maximum operating ambient temperature ( $T_A$ ) and  $R_{DS(ON)}$ , the power dissipation can be calculated by:

$$P_D = R_{DS(ON)} \times I^2$$

Finally, calculate the junction temperature:

$$T_J = P_D \times R_{\theta JA} + T_A$$

Where:

$T_A$  = Ambient temperature  $^{\circ}\text{C}$

$R_{\theta JA}$  = Thermal resistance

$P_D$  = Total power dissipation

### Thermal Protection

Thermal protection prevents the IC from damage when heavy-overload or short-circuit faults are present for extended periods of time. The AP2166/AP2176 implements a thermal sensing to monitor the operating junction temperature of the power distribution switch. Once the die temperature rises to approximately  $+140^{\circ}\text{C}$  due to excessive power dissipation in an overcurrent or short-circuit condition the internal thermal sense circuitry turns the power switch off, thus preventing the power switch from damage. Hysteresis is built into the thermal sense circuit allowing the device to cool down approximately  $+25^{\circ}\text{C}$  before the switch turns back on. The switch continues to cycle in this manner until the load fault or input power is removed. The FLG open-drain output is asserted when an over-temperature shutdown or overcurrent occurs with 7-ms deglitch.

**Application Information** (continued)

**Undervoltage Lockout (UVLO)**

Undervoltage lockout function (UVLO) keeps the internal power switch from being turned on until the power supply has reached at least 1.9V, even if the switch is enabled. Whenever the input voltage falls below approximately 1.9V, the power switch is quickly turned off. This facilitates the design of hot-insertion systems where it is not possible to turn off the power switch before input power is removed.

**Host/Self-Powered HUBS**

Hosts and self-powered hubs (SPH) have a local power supply that powers the embedded functions and the downstream ports (see Figure 2). This power supply must provide from 5.25V to 4.75V to the board side of the downstream connection under both full-load and no-load conditions. Hosts and SPHs are required to have current-limit protection and must report overcurrent conditions to the USB controller. Typical SPHs are desktop PCs, monitors, printers, and stand-alone hubs.

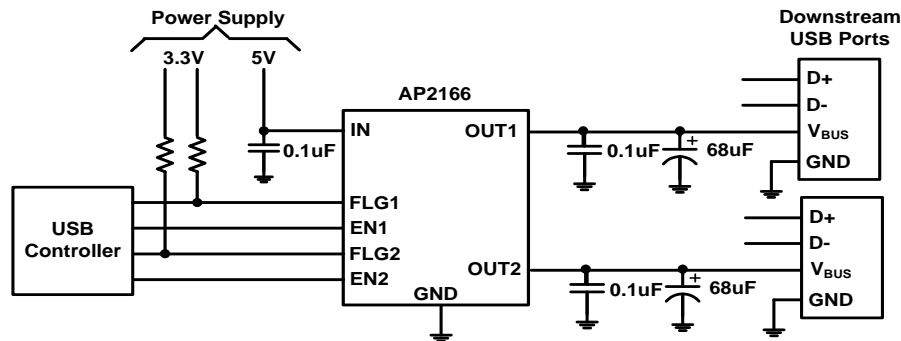

Figure 2 Typical Two-Port USB Host/ Self-Powered Hub

**Generic Hot-Plug Applications**

In many applications it may be necessary to remove modules or PC boards while the main unit is still operating. These are considered hot-plug applications. Such implementations require the control of current surges seen by the main power supply and the card being inserted. The most effective way to control these surges is to limit and slowly ramp the current and voltage being applied to the card, similar to the way in which a power supply normally turns on. Due to the controlled rise times and fall times of the AP2166/AP2176, these devices can be used to provide a softer start-up to devices being hot-plugged into a powered system. The UVLO feature of the AP2166/AP2176 also ensures that the switch is off after the card has been removed, and that the switch is off during the next insertion.

By placing the AP2166/AP2176 between the V<sub>CC</sub> input and the rest of the circuitry, the input power reaches these devices first after insertion. The typical rise time of the switch is approximately 1ms, providing a slow voltage ramp at the output of the device. This implementation controls system surge current and provides a hot-plugging mechanism for any device.

### Ordering Information

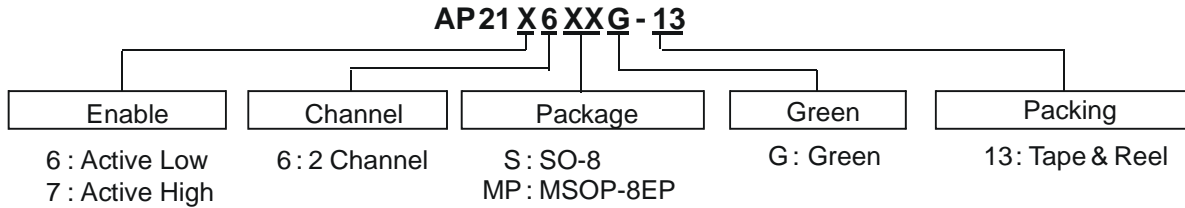

Part Number	Package Code	Packaging	13" Tape and Reel	
			Quantity	Part Number Suffix
AP21X6SG-13	S	SO-8	2,500/Tape & Reel	-13
AP21X6MPG-13	MP	MSOP-8EP	2,500/Tape & Reel	-13

### Marking Information

(1) SO-8

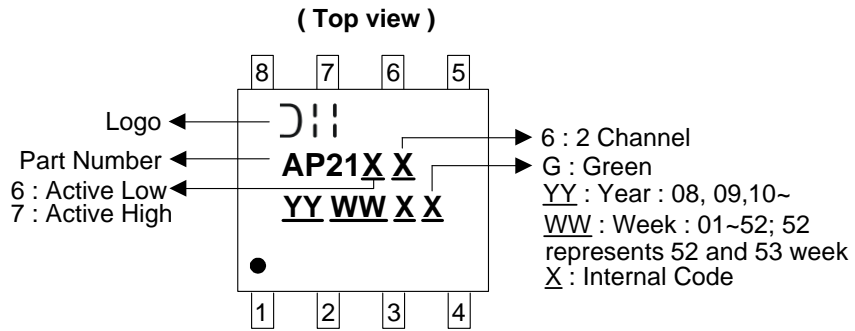

(2) MSOP-8EP

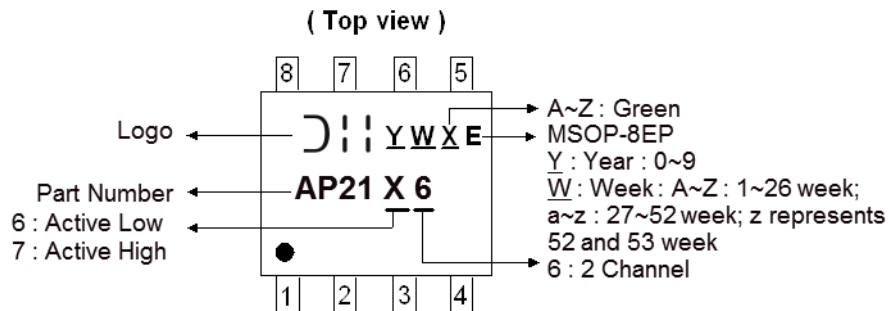

**Package Outline Dimensions** (All dimensions in mm.)

Please see <http://www.diodes.com/package-outlines.html> for the latest version.

**(1) Package type: SO-8**

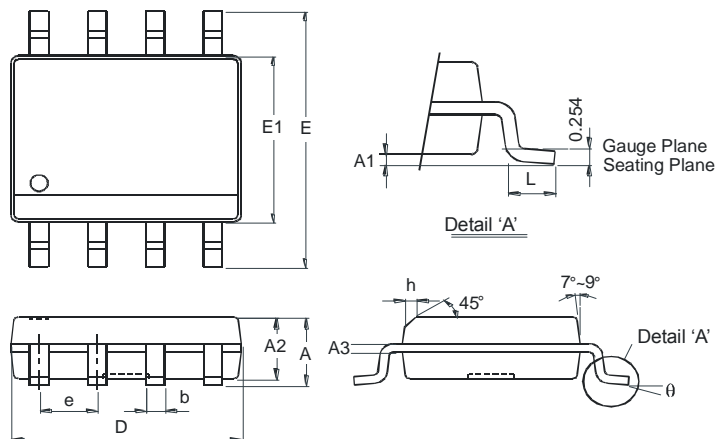

SO-8		
Dim	Min	Max
A	-	1.75
A1	0.10	0.20
A2	1.30	1.50
A3	0.15	0.25
b	0.3	0.5
D	4.85	4.95
E	5.90	6.10
E1	3.85	3.95
e	1.27 Typ	
h	-	0.35
L	0.62	0.82
θ	0°	8°
All Dimensions in mm		

**(2) Package type: MSOP-8EP**

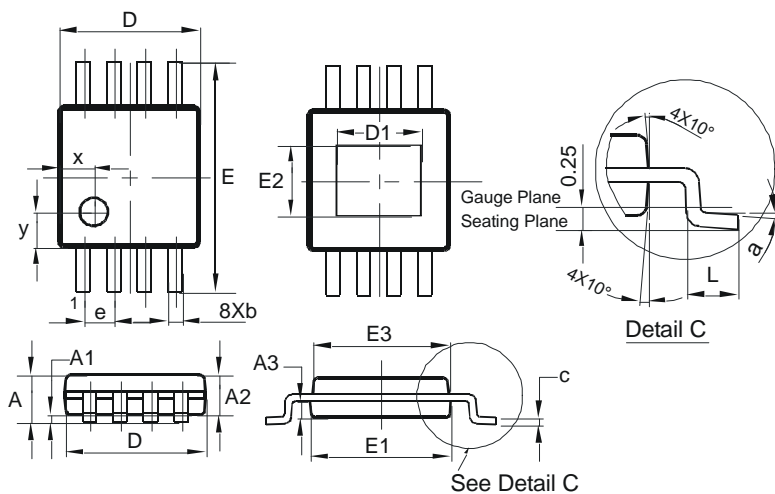

MSOP-8EP			
Dim	Min	Max	Typ
A	-	1.10	-
A1	0.05	0.15	0.10
A2	0.75	0.95	0.86
A3	0.29	0.49	0.39
b	0.22	0.38	0.30
c	0.08	0.23	0.15
D	2.90	3.10	3.00
D1	1.60	2.00	1.80
E	4.70	5.10	4.90
E1	2.90	3.10	3.00
E2	1.30	1.70	1.50
E3	2.85	3.05	2.95
e	-	-	0.65
L	0.40	0.80	0.60
a	0°	8°	4°
x	-	-	0.750
y	-	-	0.750
All Dimensions in mm			

## Suggested Pad Layout

Please see <http://www.diodes.com/package-outlines.html> for the latest version.

### (1) Package type: SO-8

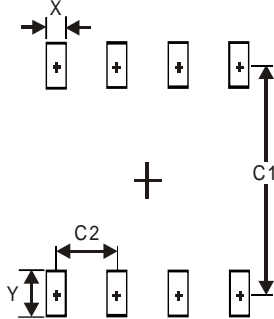

Dimensions	Value (in mm)
X	0.60
Y	1.55
C1	5.4
C2	1.27

### (2) Package type: MSOP-8EP

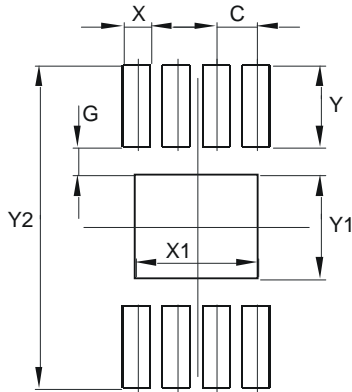

Dimensions	Value (in mm)
C	0.650
G	0.450
X	0.450
X1	2.000
Y	1.350
Y1	1.700
Y2	5.300

**IMPORTANT NOTICE**

DIODES INCORPORATED MAKES NO WARRANTY OF ANY KIND, EXPRESS OR IMPLIED, WITH REGARDS TO THIS DOCUMENT, INCLUDING, BUT NOT LIMITED TO, THE IMPLIED WARRANTIES OF MERCHANTABILITY AND FITNESS FOR A PARTICULAR PURPOSE (AND THEIR EQUIVALENTS UNDER THE LAWS OF ANY JURISDICTION).

Diodes Incorporated and its subsidiaries reserve the right to make modifications, enhancements, improvements, corrections or other changes without further notice to this document and any product described herein. Diodes Incorporated does not assume any liability arising out of the application or use of this document or any product described herein; neither does Diodes Incorporated convey any license under its patent or trademark rights, nor the rights of others. Any Customer or user of this document or products described herein in such applications shall assume all risks of such use and will agree to hold Diodes Incorporated and all the companies whose products are represented on Diodes Incorporated website, harmless against all damages.

Diodes Incorporated does not warrant or accept any liability whatsoever in respect of any products purchased through unauthorized sales channel. Should Customers purchase or use Diodes Incorporated products for any unintended or unauthorized application, Customers shall indemnify and hold Diodes Incorporated and its representatives harmless against all claims, damages, expenses, and attorney fees arising out of, directly or indirectly, any claim of personal injury or death associated with such unintended or unauthorized application.

Products described herein may be covered by one or more United States, international or foreign patents pending. Product names and markings noted herein may also be covered by one or more United States, international or foreign trademarks.

This document is written in English but may be translated into multiple languages for reference. Only the English version of this document is the final and determinative format released by Diodes Incorporated.

**LIFE SUPPORT**

Diodes Incorporated products are specifically not authorized for use as critical components in life support devices or systems without the express written approval of the Chief Executive Officer of Diodes Incorporated. As used herein:

A. Life support devices or systems are devices or systems which:

1. are intended to implant into the body, or
2. support or sustain life and whose failure to perform when properly used in accordance with instructions for use provided in the labeling can be reasonably expected to result in significant injury to the user.

B. A critical component is any component in a life support device or system whose failure to perform can be reasonably expected to cause the failure of the life support device or to affect its safety or effectiveness.

Customers represent that they have all necessary expertise in the safety and regulatory ramifications of their life support devices or systems, and acknowledge and agree that they are solely responsible for all legal, regulatory and safety-related requirements concerning their products and any use of Diodes Incorporated products in such safety-critical, life support devices or systems, notwithstanding any devices- or systems-related information or support that may be provided by Diodes Incorporated. Further, Customers must fully indemnify Diodes Incorporated and its representatives against any damages arising out of the use of Diodes Incorporated products in such safety-critical, life support devices or systems.

Copyright © 2016, Diodes Incorporated

[www.diodes.com](http://www.diodes.com)

## Looking for pricing, stock, or lifecycle information?

Click below to explore more details on WIN SOURCE:

-  [View AP2166SG-13 on WIN SOURCE](#)
-  [Diodes Incorporated Information](#)

## Optimize Your Supply Chain with WIN SOURCE Solutions

-  Global Sourcing Solution
-  Obsolete Management
-  Cost Control Management
-  Shortage Management
-  Alternative Solution
-  Excess Inventory Management