



## 4-/6-Channel Digital Potentiometers

### FEATURES

- ▶ 256 positions
- ▶ Multiple independently programmable channels
  - ▶ AD5204—4-channel
  - ▶ AD5206—6-channel
- ▶ Potentiometer replacement
- ▶ Terminal resistance of 10 kΩ, 50 kΩ, 100 kΩ
- ▶ 3-wire SPI-compatible serial data input
- ▶ +2.7 V to +5.5 V single-supply operation; ±2.7 V dual-supply operation
- ▶ Power-on midscale preset

### APPLICATIONS

- ▶ Mechanical potentiometer replacement
- ▶ Instrumentation: gain, offset adjustment
- ▶ Programmable voltage-to-current conversion
- ▶ Programmable filters, delays, time constants
- ▶ Line impedance matching

### GENERAL DESCRIPTION

The AD5204/AD5206 provide 4-/6-channel, 256-position digitally controlled variable resistor (VR) devices. These devices perform the same electronic adjustment function as a potentiometer or variable resistor. Each channel of the AD5204/AD5206 contains a fixed resistor with a wiper contact that taps the fixed resistor value at a point determined by a digital code loaded into the SPI-compatible serial-input register. The resistance between the wiper and either endpoint of the fixed resistor varies linearly with respect to the digital code transferred into the VR latch. The variable resistor offers a completely programmable value of resistance between the A terminal and the wiper or the B terminal and the wiper. The fixed A-to-B terminal resistance of 10 kΩ, 50 kΩ, or 100 kΩ has a nominal temperature coefficient of 700 ppm/°C.

Each VR has its own VR latch that holds its programmed resistance value. These VR latches are updated from an internal serial-to-parallel shift register that is loaded from a standard 3-wire serial-input digital interface. Eleven data bits make up the data-word clocked into the serial input register. The first three bits are decoded to determine which VR latch is loaded with the last eight bits of the data-word when the  $\overline{CS}$  strobe is returned to logic high. A serial

### FUNCTIONAL BLOCK DIAGRAMS

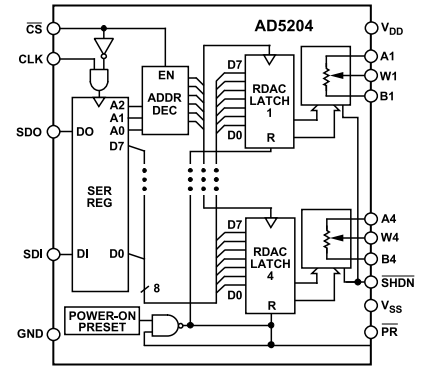

Figure 1.

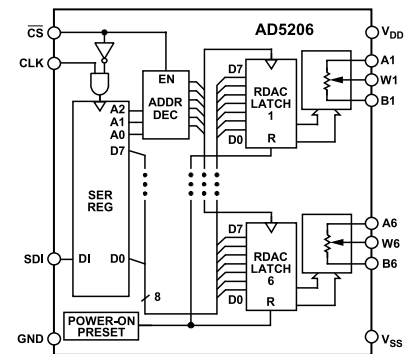

Figure 2.

data output pin at the opposite end of the serial register (AD5204 only) allows simple daisy chaining in multiple VR applications without requiring additional external decoding logic.

An optional reset ( $\overline{PR}$ ) pin forces all the AD5204 wipers to the midscale position by loading 0x80 into the VR latch.

The AD5204/AD5206 are available in the 24-lead surface-mount SOIC and TSSOP packages. The AD5204 is also available in a 32-lead, 5 mm × 5 mm LFCSP package. All parts are guaranteed to operate over the extended industrial temperature range of -40°C to +85°C. For additional single-, dual-, and quad-channel devices, see the AD8400/AD8402/AD8403 data sheets.

Rev. F

DOCUMENT FEEDBACK

TECHNICAL SUPPORT

Information furnished by Analog Devices is believed to be accurate and reliable "as is". However, no responsibility is assumed by Analog Devices for its use, nor for any infringements of patents or other rights of third parties that may result from its use. Specifications subject to change without notice. No license is granted by implication or otherwise under any patent or patent rights of Analog Devices. Trademarks and registered trademarks are the property of their respective owners.

## TABLE OF CONTENTS

Features.....	1	Pin Configurations and Function Descriptions.....	7
Applications.....	1	Typical Performance Characteristics.....	10
Functional Block Diagrams.....	1	Test Circuits.....	12
General Description.....	1	Theory of Operation.....	13
Specifications.....	3	Programming the Variable Resistor.....	13
Electrical Characteristics.....	3	Programming the Potentiometer Divider.....	14
Timing Diagrams.....	5	Digital Interfacing.....	14
Absolute Maximum Ratings.....	6	Outline Dimensions.....	16
Electrostatic Discharge (ESD) Ratings.....	6	Ordering Guide.....	17
ESD Ratings for AD5204/AD5206.....	6	Evaluation Boards.....	17
ESD Caution.....	6		

## REVISION HISTORY

### 5/2022—Rev. E to Rev. F

Deleted 24-Lead PDIP (Universal).....	1
Changes to General Description Section.....	1
Changed 0x40 to Midscale, 0x7F to Full Scale, 0x00 to Zero Scale, and $V_{DD}$ Range to $V_{DD}$ Throughout, Table 1.....	3
Changes to VW Settling Time Parameter, Input Logic High Parameter, and Input Logic Low Parameter, Table 1.....	3
Deleted PDIP (N-24-1) Parameter, Table 2.....	6
Added Electrostatic Discharge (ESD) Ratings Section.....	6
Added ESD Ratings for AD5204/AD5206 Section and Table 3; Renumbered Sequentially.....	6
Moved Test Circuits Section.....	12
Changed Operation Section to Theory of Operation Section.....	13
Moved Programming the Variable Resistor Section.....	13
Change to Rheostat Operation Section.....	13
Moved Programming the Potentiometer Divider Section.....	14
Moved Digital Interfacing Section and Figure 32.....	14
Updated Outline Dimensions.....	16
Changes to Ordering Guide.....	17

## SPECIFICATIONS

## ELECTRICAL CHARACTERISTICS

$V_{DD} = 5\text{ V} \pm 10\%$  or  $3\text{ V} \pm 10\%$ ,  $V_{SS} = 0\text{ V}$ ,  $V_A = V_{DD}$ ,  $V_B = 0\text{ V}$ ,  $-40^\circ\text{C} < T_A < +85^\circ\text{C}$ , unless otherwise noted.

Table 1.

Parameter	Symbol	Test Conditions/Comments	Min	Typ <sup>1</sup>	Max	Unit
<b>DC CHARACTERISTICS RHEOSTAT MODE<sup>2</sup></b>						
Resistor Differential NL <sup>3</sup>	R-DNL	$R_{WB}$ , $V_A = \text{no connect}$	-1	$\pm 0.25$	+1	LSB
Resistor Nonlinearity Error <sup>3</sup>	R-INL	$R_{WB}$ , $V_A = \text{no connect}$	-2	$\pm 0.5$	+2	LSB
Nominal Resistor Tolerance <sup>4</sup>	$\Delta R_{AB}$	$T_A = 25^\circ\text{C}$	-30		+30	%
Resistance Temperature Coefficient	$\Delta R_{AB}/\Delta T$	$V_{AB} = V_{DD}$ , wiper = no connect		700		ppm/ $^\circ\text{C}$
Nominal Resistance Match	$\Delta R/R_{AB}$	Channel 1 to Channel 2, Channel 3, and Channel 4, or to Channel 5 and Channel 6; $V_{AB} = V_{DD}$		0.25	1.5	%
Wiper Resistance	$R_W$	$I_W = 1\text{ V}/R$ , $V_{DD} = 5\text{ V}$		50	100	$\Omega$
<b>DC CHARACTERISTICS POTENTIOMETER DIVIDER MODE<sup>2</sup></b>						
Resolution	N		8			Bits
Differential Nonlinearity <sup>5</sup>	DNL		-1	$\pm 0.25$	+1	LSB
Integral Nonlinearity <sup>5</sup>	INL		-2	$\pm 0.5$	+2	LSB
Voltage Divider Temperature Coefficient	$\Delta V_W/\Delta T$	Code = midscale		15		ppm/ $^\circ\text{C}$
Full-Scale Error	$V_{WFSE}$	Code = full scale	-2	-1	0	LSB
Zero-Scale Error	$V_{WZSE}$	Code = zero scale	0	1	2	LSB
<b>RESISTOR TERMINALS</b>						
Voltage Range <sup>6</sup>	$V_A, V_B, V_W$		$V_{SS}$		$V_{DD}$	V
Capacitance <sup>7</sup> Ax, Bx	$C_A, C_B$	$f = 1\text{ MHz}$ , measured to GND, code = midscale		45		pF
Capacitance <sup>7</sup> Wx	$C_W$	$f = 1\text{ MHz}$ , measured to GND, code = midscale		60		pF
Shutdown Current <sup>8</sup>	$I_{A\_SD}$			0.01	5	$\mu\text{A}$
Common-Mode Leakage	$I_{CM}$	$V_A = V_B = V_W = 0$ , $V_{DD} = +2.7\text{ V}$ , $V_{SS} = -2.5\text{ V}$		1		nA
<b>DIGITAL INPUTS AND OUTPUTS</b>						
Input Logic High	$V_{IH}$	$V_{DD} = 5\text{ V}$ $V_{DD} = 3\text{ V}$	2.4 2.1			V V
Input Logic Low	$V_{IL}$	$V_{DD} = 5\text{ V}$ $V_{DD} = 3\text{ V}$			0.8 0.6	V V
Output Logic High	$V_{OH}$	$R_{PULL-UP} = 1\text{ k}\Omega$ to 5 V	4.9			V
Output Logic Low	$V_{OL}$	$I_{OL} = 1.6\text{ mA}$ , $V_{LOGIC} = 5\text{ V}$			0.4	V
Input Current	$I_{IL}$	$V_{IN} = 0\text{ V}$ or 5 V			$\pm 1$	$\mu\text{A}$
Input Capacitance <sup>7</sup>	$C_{IL}$			5		pF
<b>POWER SUPPLIES</b>						
Power Single-Supply Range	$V_{DD}$	$V_{SS} = 0\text{ V}$	2.7		5.5	V
Power Dual-Supply Range	$V_{DD}/V_{SS}$		$\pm 2.3$		$\pm 2.7$	V
Positive Supply Current	$I_{DD}$	$V_{IH} = 5\text{ V}$ or $V_{IL} = 0\text{ V}$		12	60	$\mu\text{A}$
Negative Supply Current	$I_{SS}$	$V_{SS} = -2.5\text{ V}$ , $V_{DD} = +2.7\text{ V}$		12	60	$\mu\text{A}$
Power Dissipation <sup>9</sup>	$P_{DISS}$	$V_{IH} = 5\text{ V}$ or $V_{IL} = 0\text{ V}$			0.3	mW
Power Supply Sensitivity	PSS	$\Delta V_{DD} = 5\text{ V} \pm 10\%$		0.0002	0.005	%/%
<b>DYNAMIC CHARACTERISTICS<sup>7, 10</sup></b>						
Bandwidth -3 dB	BW_10K BW_50K	$R_{AB} = 10\text{ k}\Omega$ $R_{AB} = 50\text{ k}\Omega$		721 137		kHz kHz

## SPECIFICATIONS

Table 1.

Parameter	Symbol	Test Conditions/Comments	Min	Typ <sup>1</sup>	Max	Unit
Total Harmonic Distortion	BW_100K THD <sub>W</sub>	R <sub>AB</sub> = 100 kΩ V <sub>A</sub> = 1.414 V rms, V <sub>B</sub> = 0 V dc, f = 1 kHz		69 0.004		kHz %
VW Settling Time	t <sub>S</sub>	V <sub>A</sub> = 5 V, V <sub>B</sub> = 0 V, ±1 LSB error band R <sub>AB</sub> = 10 kΩ R <sub>AB</sub> = 50 kΩ R <sub>AB</sub> = 100 kΩ		2 9 18		μs μs μs
Resistor Noise Voltage	e <sub>N_WB</sub>	R <sub>WB</sub> = 5 kΩ, f = 1 kHz, $\overline{PR}$ = 0		9		nV/√Hz
INTERFACE TIMING CHARACTERISTICS <sup>7, 11, 12</sup>						
Input Clock Pulse Width	t <sub>CH</sub> , t <sub>CL</sub>	Clock level high or low	20			ns
Data Setup Time	t <sub>DS</sub>		5			ns
Data Hold Time	t <sub>DH</sub>		5			ns
CLK-to-SDO Propagation Delay <sup>13</sup>	t <sub>PD</sub>	R <sub>L</sub> = 2 kΩ, C <sub>L</sub> < 20 pF	1		150	ns
Setup Time	t <sub>CSS</sub>		15			ns
$\overline{CS}$ High Pulse Width	t <sub>CSW</sub>		40			ns
Reset Pulse Width	t <sub>RS</sub>		90			ns
CLK Fall to $\overline{CS}$ Fall Setup	t <sub>CSh0</sub>		0			ns
CLK Fall to $\overline{CS}$ Rise Hold Time	t <sub>CSh1</sub>		0			ns
$\overline{CS}$ Rise to Clock Rise Setup	t <sub>CS1</sub>		10			ns

<sup>1</sup> Typical values represent average readings at 25°C and V<sub>DD</sub> = 5 V.

<sup>2</sup> Applies to all VRs.

<sup>3</sup> Resistor position nonlinearity error (R-INL) is the deviation from an ideal value measured between the maximum resistance and the minimum resistance wiper positions. R-DNL measures the relative step change from the ideal position between successive tap positions. Parts are guaranteed monotonic. See the test circuit in Figure 24. I<sub>W</sub> = V<sub>DD</sub>/R for both V<sub>DD</sub> = 3 V and V<sub>DD</sub> = 5 V.

<sup>4</sup> V<sub>AB</sub> = V<sub>DD</sub>, wiper (V<sub>W</sub>) = no connect.

<sup>5</sup> INL and DNL are measured at V<sub>W</sub> with the RDAC configured as a potentiometer divider similar to a voltage output DAC. V<sub>A</sub> = V<sub>DD</sub> and V<sub>B</sub> = 0 V. DNL specification limits of ±1 LSB maximum are guaranteed monotonic at operating conditions. See the test circuit in Figure 23.

<sup>6</sup> Resistor Terminal A, Terminal B, and Wiper W have no limitations on polarity with respect to each other.

<sup>7</sup> Guaranteed by design and not subject to production test.

<sup>8</sup> Measured at the Ax terminals. All Ax terminals are open circuited in shutdown mode.

<sup>9</sup> P<sub>DISS</sub> is calculated from (I<sub>DD</sub> × V<sub>DD</sub>). CMOS logic level inputs result in minimum power dissipation.

<sup>10</sup> All dynamic characteristics use V<sub>DD</sub> = 5 V.

<sup>11</sup> Applies to all parts.

<sup>12</sup> See the timing diagrams (Figure 3 to Figure 5) for the location of the measured values. All input control voltages are specified with t<sub>R</sub> = t<sub>F</sub> = 2.5 ns (10% to 90% of 3 V) and timed from a voltage level of 1.5 V. Switching characteristics are measured using both V<sub>DD</sub> = 3 V and V<sub>DD</sub> = 5 V.

<sup>13</sup> The propagation delay depends on the values of V<sub>DD</sub>, R<sub>L</sub>, and C<sub>L</sub> (see the Theory of Operation section).

TIMING DIAGRAMS

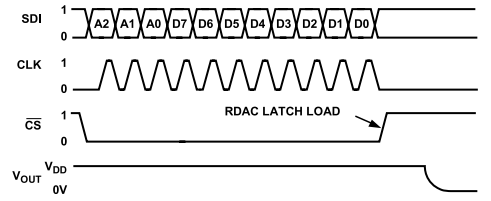

Figure 3. Timing Diagram

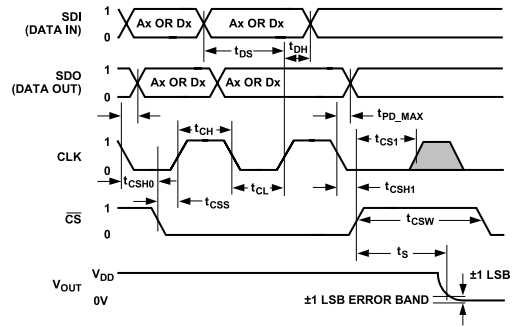

Figure 4. Detailed Timing Diagram

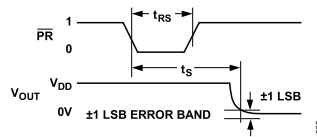

Figure 5. AD5204 Preset Timing Diagram

**ABSOLUTE MAXIMUM RATINGS**

$T_A = 25^\circ\text{C}$ , unless otherwise noted.

**Table 2.**

Parameter	Rating
$V_{DD}$ to GND	-0.3 V to +7 V
$V_{SS}$ to GND	0 V to -7 V
$V_{DD}$ to $V_{SS}$	7 V
$V_A, V_B, V_W$ to GND	$V_{SS}, V_{DD}$
$I_A, I_B, I_W$	
Pulsed <sup>1</sup>	$\pm 20$ mA
Continuous	
10 k $\Omega$ End-to-End Resistance	$\pm 11$ mA
50 k $\Omega$ and 100 k $\Omega$ End-to-End Resistance	$\pm 2.5$ mA
Digital Input and Output Voltage to GND	-0.3 V to ( $V_{DD} + 0.3$ V) or 7 V (whichever is less)
Operating Temperature Range	-40°C to +85°C
Maximum Junction Temperature ( $T_{J \text{ max}}$ )	150°C
Storage Temperature	-65°C to +150°C
Reflow Soldering	
Peak Temperature	260°C
Time at Peak Temperature	20 sec to 40 sec
Package Power Dissipation	$(T_{J \text{ max}} - T_A)/\theta_{JA}$
Thermal Resistance, $\theta_{JA}$ <sup>2</sup>	
SOIC (RW-24)	52°C/W
TSSOP (RU-24)	50°C/W
LFCSP (CP-32-13)	32.5°C/W

<sup>1</sup> Maximum terminal current is bounded by the maximum current handling of the switches, maximum power dissipation of the package, and maximum applied voltage across any two of the A, B, and W terminals at a given resistance.

<sup>2</sup> Thermal resistance (JEDEC 4-layer (2S2P) board). Paddle soldered to board.

Stresses at or above those listed under Absolute Maximum Ratings may cause permanent damage to the product. This is a stress rating only; functional operation of the product at these or any other conditions above those indicated in the operational section of this specification is not implied. Operation beyond the maximum operating conditions for extended periods may affect product reliability.

**ELECTROSTATIC DISCHARGE (ESD) RATINGS**

The following ESD information is provided for handling of ESD-sensitive devices in and ESD-protected area only.

Human body model (HBM) per ANSI/ESDA/JEDEC JS-001.

Field induced charged device model (FICDM) and charged device model (CDM) per ANSI/ESDA/JEDEC JS-002.

**ESD RATINGS FOR AD5204/AD5206****Table 3. AD5204/AD5206, 24-Lead TSSOP, 24-Lead SOIC, and 32-Lead LFCSP**

ESD Model	Withstand Threshold	
	(V)	Class
HBM	1000 V	1C
FICDM	1500 V	C3

**ESD CAUTION**

**ESD (electrostatic discharge) sensitive device.** Charged devices and circuit boards can discharge without detection. Although this product features patented or proprietary protection circuitry, damage may occur on devices subjected to high energy ESD. Therefore, proper ESD precautions should be taken to avoid performance degradation or loss of functionality.

PIN CONFIGURATIONS AND FUNCTION DESCRIPTIONS

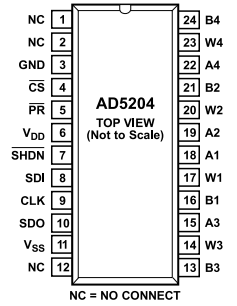

Figure 6. AD5204 SOIC/TSSOP Pin Configuration

Table 4. AD5204 SOIC/TSSOP Pin Function Descriptions

Pin No.	Name	Description
1, 2, 12	NC	Not Connected.
3	GND	Ground.
4	$\overline{CS}$	Chip Select Input (Active Low). When $\overline{CS}$ returns high, data in the serial input register is decoded based on the address bits, and then it is loaded into the target RDAC latch.
5	$\overline{PR}$	Preset to Midscale (Active Low). This pin sets the RDAC registers to 0x80.
6	$V_{DD}$	Positive Power Supply. This pin is specified for operation at both 3 V and 5 V. It is the sum of $ V_{DD}  +  V_{SS}  < 5.5$ V.
7	$\overline{SHDN}$	Terminal A Open-Circuit Shutdown (Active Low Input). This pin controls VR 1 through VR 4.
8	SDI	Serial Data Input. Data is input MSB first.
9	CLK	Serial Clock Input. This pin is positive edge triggered.
10	SDO	Serial Data Output. This pin is an open-drain transistor and requires a pull-up resistor.
11	$V_{SS}$	Negative Power Supply. This pin is specified for operation at both 0 V and -2.7 V. It is the sum of $ V_{DD}  +  V_{SS}  < 5.5$ V.
13	B3	Terminal B RDAC 3.
14	W3	Wiper RDAC 3. Address = 010 <sub>2</sub> .
15	A3	Terminal A RDAC 3.
16	B1	Terminal B RDAC 1.
17	W1	Wiper RDAC 1. Address = 000 <sub>2</sub> .
18	A1	Terminal A RDAC 1.
19	A2	Terminal A RDAC 2.
20	W2	Wiper RDAC 2. Address = 001 <sub>2</sub> .
21	B2	Terminal B RDAC 2.
22	A4	Terminal A RDAC 4.
23	W4	Wiper RDAC 4. Address = 011 <sub>2</sub> .
24	B4	Terminal B RDAC 4.

PIN CONFIGURATIONS AND FUNCTION DESCRIPTIONS

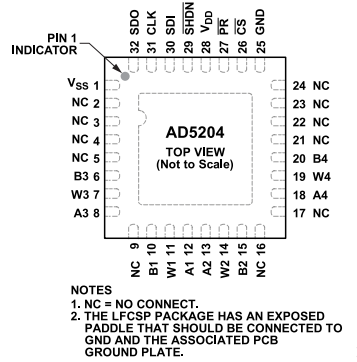

Figure 7. AD5204 LFCSP Pin Configuration

Table 5. AD5204 LFCSP Pin Function Descriptions

Pin No.	Name	Description
1	V <sub>SS</sub>	Negative Power Supply. This pin is specified for operation at both 0 V and -2.7 V. It is the sum of $ V_{DD}  +  V_{SS}  < 5.5$ V.
2 to 5, 9, 16, 17, 21 to 24	NC	Not Connected.
6	B3	Terminal B RDAC 3.
7	W3	Wiper RDAC 3. Address = 010 <sub>2</sub> .
8	A3	Terminal A RDAC 3.
10	B1	Terminal B RDAC 1.
11	W1	Wiper RDAC 1. Address = 000 <sub>2</sub> .
12	A1	Terminal A RDAC 1.
13	A2	Terminal A RDAC 2.
14	W2	Wiper RDAC 2. Address = 001 <sub>2</sub> .
15	B2	Terminal B RDAC 2.
18	A4	Terminal A RDAC 4.
19	W4	Wiper RDAC 4. Address = 011 <sub>2</sub> .
20	B4	Terminal B RDAC 4.
25	GND	Ground.
26	$\overline{CS}$	Chip Select Input (Active Low). When $\overline{CS}$ returns high, data in the serial input register is decoded based on the address bits, and then it is loaded into the target RDAC latch.
27	$\overline{PR}$	Preset to Midscale (Active Low). This pin sets the RDAC registers to 0x80.
28	V <sub>DD</sub>	Positive Power Supply. This pin is specified for operation at both 3 V and 5 V. It is the sum of $ V_{DD}  +  V_{SS}  < 5.5$ V.
29	$\overline{SHDN}$	Terminal A Open-Circuit Shutdown (Active Low Input). This pin controls VR 1 through VR 4.
30	SDI	Serial Data Input. Data is input MSB first.
31	CLK	Serial Clock Input. This pin is positive edge triggered.
32	SDO	Serial Data Output. This pin is an open-drain transistor and requires a pull-up resistor.

## PIN CONFIGURATIONS AND FUNCTION DESCRIPTIONS

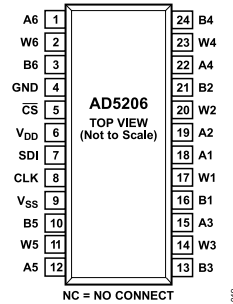

Figure 8. AD5206 SOIC/TSSOP Pin Configuration

Table 6. AD5206 Pin Function Descriptions

Pin No.	Name	Description
1	A6	Terminal A RDAC 6.
2	W6	Wiper RDAC 6. Address = $101_2$ .
3	B6	Terminal B RDAC 6.
4	GND	Ground.
5	$\overline{CS}$	Chip Select Input (Active Low). When $\overline{CS}$ returns high, data in the serial input register is decoded based on the address bits, and then it is loaded into the target RDAC latch.
6	$V_{DD}$	Positive Power Supply. This pin is specified for operation at both 3 V and 5 V. It is the sum of $ V_{DD}  +  V_{SS}  < 5.5$ V.
7	SDI	Serial Data Input. Data is input MSB first.
8	CLK	Serial Clock Input. This pin is positive edge triggered.
9	$V_{SS}$	Negative Power Supply. This pin is specified for operation at both 0 V and $-2.7$ V. It is the sum of $ V_{DD}  +  V_{SS}  < 5.5$ V.
10	B5	Terminal B RDAC 5.
11	W5	Wiper RDAC 5. Address = $100_2$ .
12	A5	Terminal A RDAC 5.
13	B3	Terminal B RDAC 3.
14	W3	Wiper RDAC 3. Address = $010_2$ .
15	A3	Terminal A RDAC 3.
16	B1	Terminal B RDAC 1.
17	W1	Wiper RDAC 1. Address = $000_2$ .
18	A1	Terminal A RDAC 1.
19	A2	Terminal A RDAC 2.
20	W2	Wiper RDAC 2. Address = $001_2$ .
21	B2	Terminal B RDAC 2.
22	A4	Terminal A RDAC 4.
23	W4	Wiper RDAC 4. Address = $011_2$ .
24	B4	Terminal B RDAC 4.

TYPICAL PERFORMANCE CHARACTERISTICS

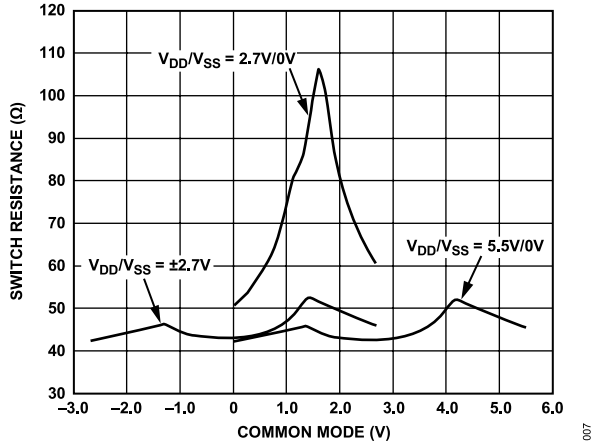

Figure 9. Incremental On Resistance of the Wiper vs. Voltage

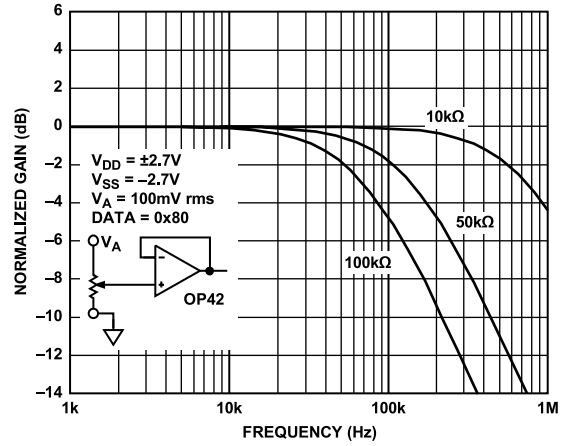

Figure 12. -3 dB Bandwidth vs. Terminal Resistance, ±2.7 V Dual-Supply Operation

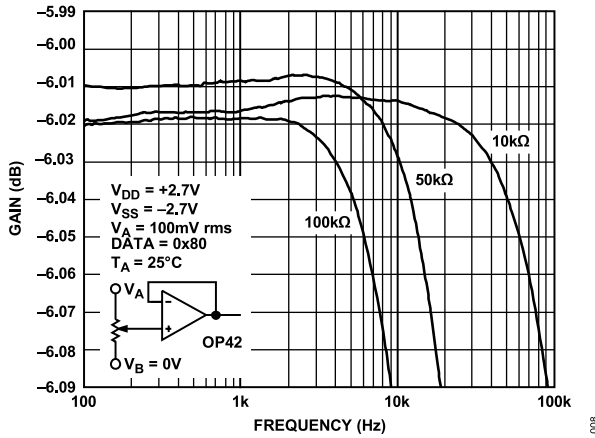

Figure 10. Gain Flatness vs. Frequency

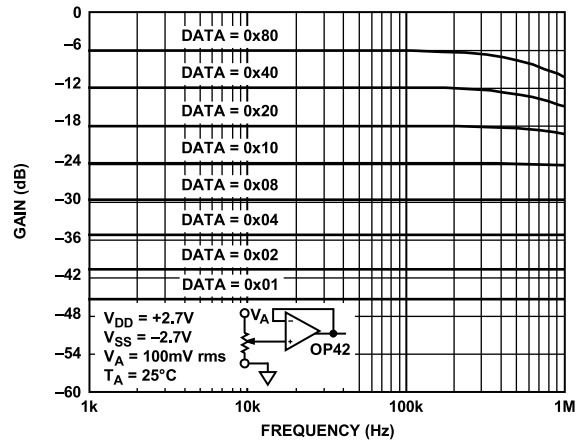

Figure 13. Bandwidth vs. Code, 10 kΩ Version

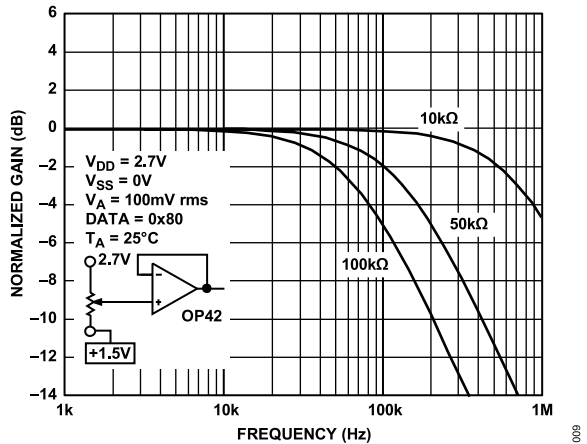

Figure 11. -3 dB Bandwidth vs. Terminal Resistance, 2.7 V Single-Supply Operation

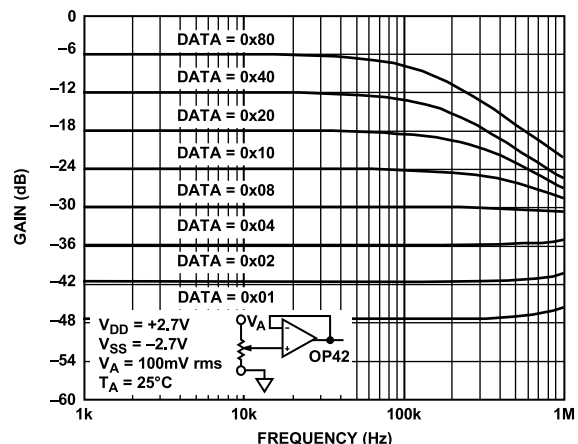

Figure 14. Bandwidth vs. Code, 50 kΩ Version

TYPICAL PERFORMANCE CHARACTERISTICS

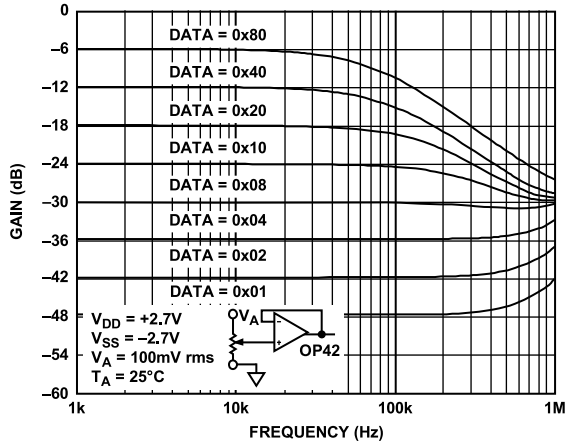

Figure 15. Bandwidth vs. Code, 100 kΩ Version

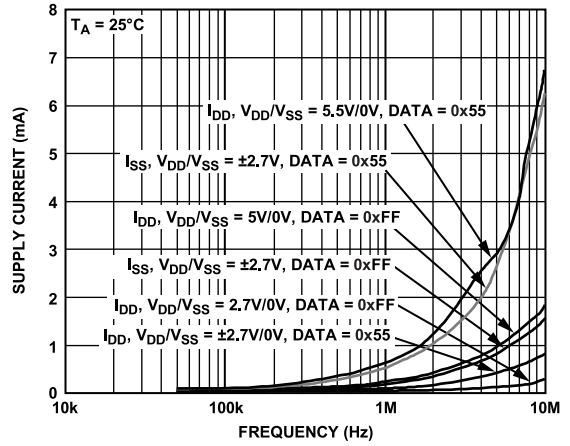

Figure 18. Supply Current vs. Clock Frequency

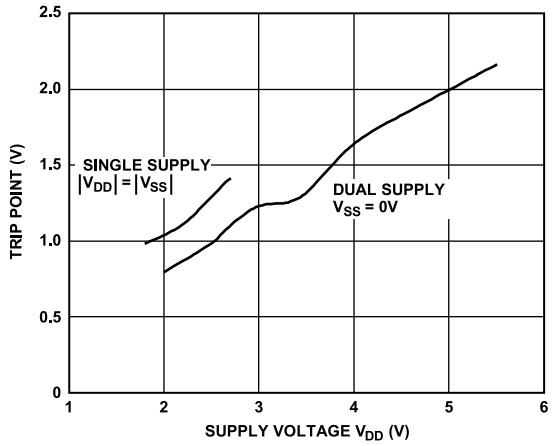

Figure 16. Digital Input Trip Point vs. Supply Voltage

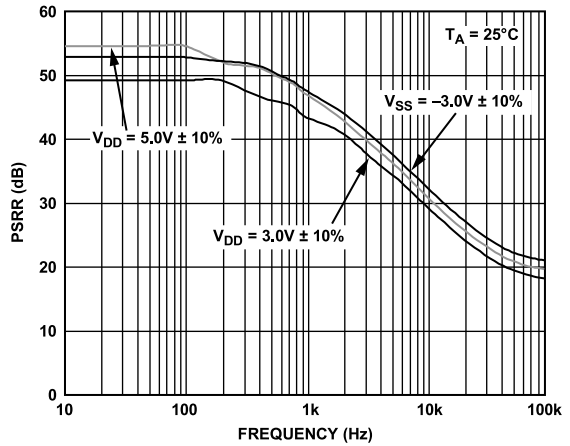

Figure 19. Power Supply Rejection vs. Frequency

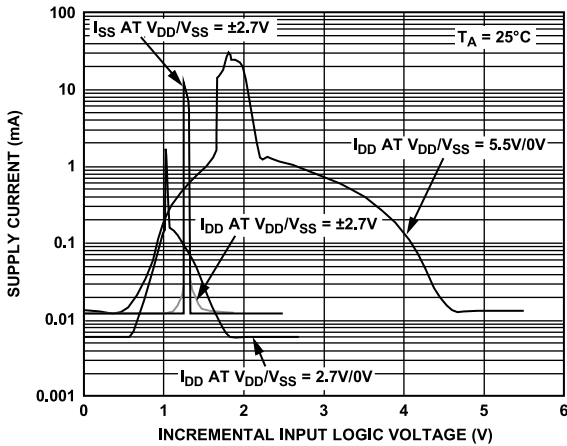

Figure 17. Supply Current vs. Input Logic Voltage

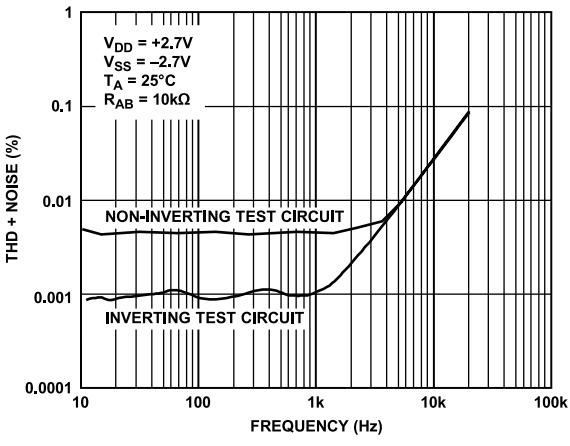

Figure 20. Total Harmonic Distortion Plus Noise vs. Frequency

TEST CIRCUITS

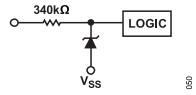

Figure 21. ESD Protection of Digital Pins

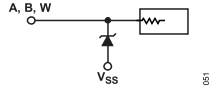

Figure 22. ESD Protection of Resistor Terminals

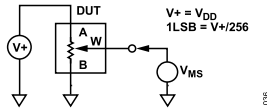

Figure 23. Potentiometer Divider Nonlinearity Error Test Circuit (INL, DNL)

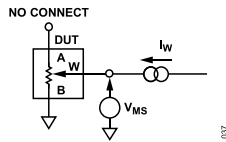

Figure 24. Resistor Position Nonlinearity Error (Rheostat Operation; R-INL, R-DNL)

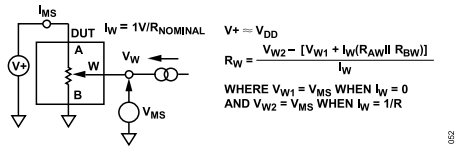

Figure 25. Wiper Resistance Test Circuit

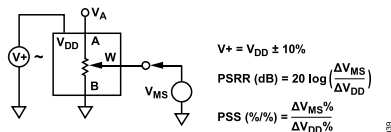

Figure 26. Power Supply Sensitivity Test Circuit (PSS, PSRR)

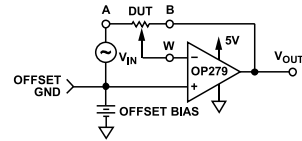

Figure 27. Inverting Programmable Gain Test Circuit

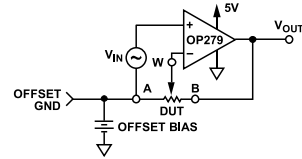

Figure 28. Noninverting Programmable Gain Test Circuit

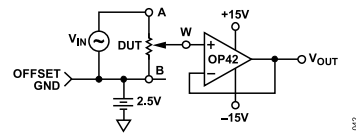

Figure 29. Gain vs. Frequency Test Circuit

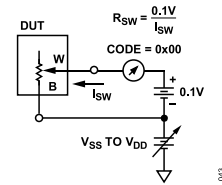

Figure 30. Incremental On-Resistance Test Circuit

## THEORY OF OPERATION

The AD5204 provides a 4-channel, 256-position digitally controlled VR device, and the AD5206 provides a 6-channel, 256-position digitally controlled VR device. Changing the programmed VR settings is accomplished by clocking an 11-bit serial data-word into the SDI pin. The format of this data-word is three address bits, MSB first, followed by eight data bits, MSB first. Table 7 provides the serial register data-word format.

Table 7. Serial Data-Word Format

Address			Data							
B10	B9	B8	B7	B6	B5	B4	B3	B2	B1	B0
A2	A1	A0	D7	D6	D5	D4	D3	D2	D1	D0
MSB		LSB								LSB
$2^{10}$		$2^8$								$2^0$

See Table 11 for the AD5204/AD5206 address assignments to decode the location of the VR latch receiving the serial register data in Bit B7 through Bit B0. The VR outputs can be changed one at a time in random sequence. The AD5204 presets to midscale by asserting the PR pin, simplifying fault condition recovery at power up. Both parts have an internal power-on preset that places the wiper in a preset midscale condition at power on. In addition, the AD5204 contains a power shutdown pin (SHDN) that places the RDAC in a zero power consumption state, where terminals Ax are open circuited and wipers Wx are connected to terminals Bx, resulting in only leakage currents being consumed in the VR structure. In shutdown mode, the VR latch settings are maintained so that the VR settings return to their previous resistance values when the device is returned to operational mode from power shutdown.

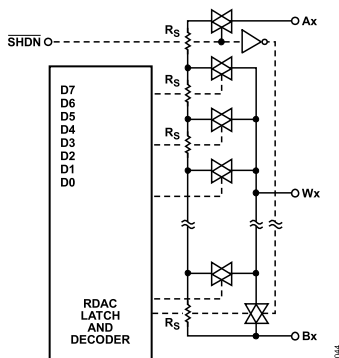

Figure 31. AD5204/AD5206 Equivalent RDAC Circuit

## PROGRAMMING THE VARIABLE RESISTOR

### Rheostat Operation

The nominal resistance of the RDAC between Terminal A and Terminal B is available with values of 10 kΩ, 50 kΩ, and 100 kΩ. The last digits of the part number determine the nominal resistance value; for example, 10 kΩ = 10 and 100 kΩ = 100. The nominal resistance ( $R_{AB}$ ) of the VR has 256 contact points accessed by the wiper terminal, plus Terminal B contact. The 8-bit data-word in the RDAC latch is decoded to select one of the 256 possible settings.

The first connection of the wiper starts at Terminal B for the 0x00 data. This Terminal B connection has a wiper contact resistance of 45 Ω. The second connection (for a 10 kΩ part) is the first tap point, located at  $84 \Omega [= R_{AB} (\text{nominal resistance})/256 + R_W = 39 \Omega + 45 \Omega]$  for the 0x01 data. The third connection is the next tap point, representing  $78 + 45 = 123 \Omega$  for the 0x02 data. Each LSB data value increase moves the wiper up the resistor ladder until the last tap point is reached at 10,006 Ω. The wiper does not directly connect to Terminal A. See Figure 31 for a simplified diagram of the equivalent RDAC circuit.

The general transfer equation determining the digitally programmed output resistance between the Wx and Bx terminals is

$$R_{WB}(Dx) = (Dx)/256 \times R_{AB} + R_W \quad (1)$$

where  $Dx$  is the data contained in the 8-bit RDACx latch, and  $R_{AB}$  is the nominal end-to-end resistance.

For example, when  $V_B = 0 \text{ V}$  and Terminal A is open circuited, the output resistance values are set as outlined in Table 8 for the RDAC latch codes (applies to the 10 kΩ potentiometer).

Table 8. Output Resistance Values for the RDAC Latch Codes— $V_B = 0 \text{ V}$  and Terminal A = Open Circuited

D (Dec)	$R_{WB} (\Omega)$	Output State
255	10006	Full scale
128	5045	Midscale ( $\overline{PR} = 0$ condition)
1	84	1 LSB
0	45	Zero scale (wiper contact resistance)

In the zero-scale condition, a finite total wiper resistance of 45 Ω is present. Regardless of which setting the part is operating in, care should be taken to limit the current between Terminal A to Terminal B, Wiper W to Terminal A, and Wiper W to Terminal B, to the maximum continuous current of  $\pm 5.65 \text{ mA}$  (10 kΩ) or  $\pm 1.35 \text{ mA}$  (50 kΩ and 100 kΩ) or pulse current of  $\pm 20 \text{ mA}$ . Otherwise, degradation or possible destruction of the internal switch contact, can occur.

Like the mechanical potentiometer that the RDAC replaces, the RDAC is completely symmetrical. The resistance between Wiper W and Terminal A produces a digitally controlled resistance,  $R_{WA}$ . When these terminals are used, Terminal B should be tied to the wiper. Setting the resistance value for  $R_{WA}$  starts at a maximum value of resistance and decreases as the data loaded to the latch is increased in value. The general transfer equation for this operation is

$$R_{WA}(Dx) = (256 - Dx)/256 \times R_{AB} + R_W \quad (2)$$

where  $Dx$  is the data contained in the 8-bit RDACx latch, and  $R_{AB}$  is the nominal end-to-end resistance.

For example, when  $V_A = 0 \text{ V}$  and Terminal B is tied to Wiper W, the output resistance values outlined in Table 9 are set for the RDAC latch codes.



## THEORY OF OPERATION

Table 11. Address Decode Table

A2	A1	A0	Latch Decoded
0	0	0	RDAC 1
0	0	1	RDAC 2
0	1	0	RDAC 3
0	1	1	RDAC 4
1	0	0	RDAC 5 AD5206 only
1	0	1	RDAC 6 AD5206 only

The data setup and data hold times in the specification table determine the data valid time requirements. The last 11 bits of the data-word entered into the serial register are held when  $\overline{CS}$  returns high. When  $\overline{CS}$  goes high, the address decoder is gated, enabling one of four or six positive-edge-triggered RDAC latches (see Figure 33 for details).

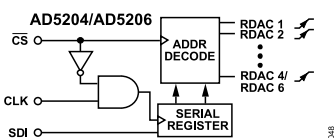

Figure 33. Equivalent Input Control Logic

The target RDAC latch is loaded with the last eight bits of the serial data-word, completing one DAC update. Four separate 8-bit data-words must be clocked in to change all four VR settings.

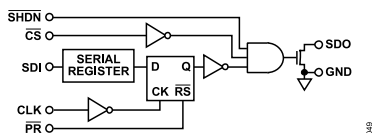
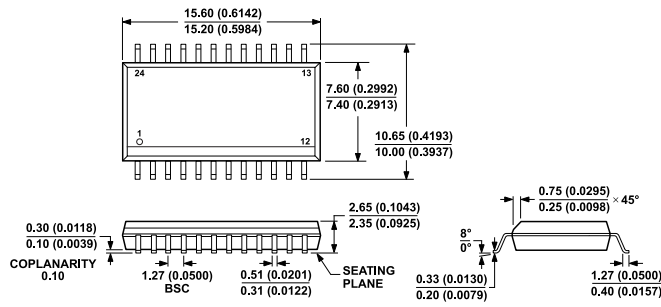

Figure 34. Detail SDO Output Schematic of the AD5204

All digital pins ( $\overline{CS}$ , SDI, SDO,  $\overline{PR}$ ,  $\overline{SHDN}$ , and CLK) are protected with a series input resistor and a parallel Zener ESD structure (see Figure 21).

OUTLINE DIMENSIONS



COMPLIANT TO JEDEC STANDARDS MS-013-AD  
 CONTROLLING DIMENSIONS ARE IN MILLIMETERS; INCH DIMENSIONS  
 (IN PARENTHESES) ARE ROUNDED-OFF MILLIMETER EQUIVALENTS FOR  
 REFERENCE ONLY AND ARE NOT APPROPRIATE FOR USE IN DESIGN.

15249-010-4

**Figure 35. 24-Lead Standard Small Outline Package [SOIC\_W]  
 Wide Body  
 (RW-24)**  
 Dimensions shown in millimeters and (inches)

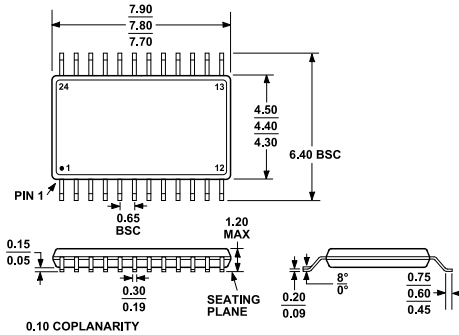

COMPLIANT TO JEDEC STANDARDS MO-153-AD

**Figure 36. 24-Lead Thin Shrink Small Outline Package [TSSOP]  
 (RU-24)**  
 Dimensions shown in millimeters

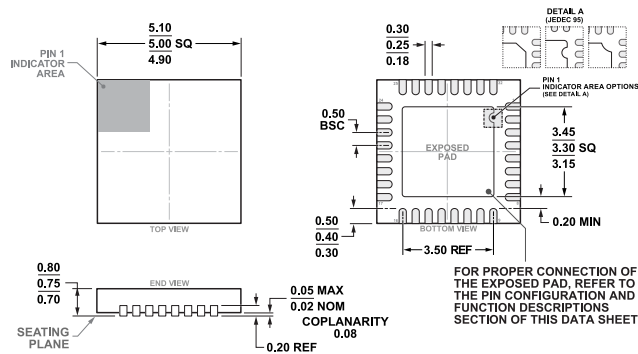

COMPLIANT TO JEDEC STANDARDS MO-220-WHHD.

05-11-2010 16-48

**Figure 37. 32-Lead Lead Frame Chip Scale Package [LFCSP]  
 5 mm x 5 mm Body and 0.75 mm Package Height  
 (CP-32-13)**  
 Dimensions shown in millimeters

## OUTLINE DIMENSIONS

Updated: May 11, 2022

## ORDERING GUIDE

Model <sup>1</sup>	Temperature Range	Package Description	Packing Quantity	Package Option
AD5204BCPZ10-REEL	-40°C to +85°C	32-Lead LFCSP (5mm x 5mm x 0.75mm w/ EP)	Reel, 5000	CP-32-13
AD5204BCPZ10-REEL7	-40°C to +85°C	32-Lead LFCSP (5mm x 5mm x 0.75mm w/ EP)	Reel, 1500	CP-32-13
AD5204BRUZ10	-40°C to +85°C	24-Lead TSSOP	Tube	RU-24
AD5204BRUZ100	-40°C to +85°C	24-Lead TSSOP	Tube	RU-24
AD5204BRUZ100-R7	-40°C to +85°C	24-Lead TSSOP	Reel, 1000	RU-24
AD5204BRUZ10-REEL7	-40°C to +85°C	24-Lead TSSOP	Reel, 1000	RU-24
AD5204BRUZ50	-40°C to +85°C	24-Lead TSSOP	Tube	RU-24
AD5204BRUZ50-REEL7	-40°C to +85°C	24-Lead TSSOP	Reel, 1000	RU-24
AD5204BRZ10	-40°C to +85°C	24-Lead SOIC (Wide)	Tube	RW-24
AD5204BRZ100	-40°C to +85°C	24-Lead SOIC (Wide)	Tube	RW-24
AD5204BRZ10-REEL	-40°C to +85°C	24-Lead SOIC (Wide)	Reel, 1000	RW-24
AD5204BRZ50-REEL	-40°C to +85°C	24-Lead SOIC (Wide)	Reel, 1000	RW-24
AD5206BRUZ10	-40°C to +85°C	24-Lead TSSOP	Tube	RU-24
AD5206BRUZ100-RL7	-40°C to +85°C	24-Lead TSSOP	Reel, 1000	RU-24
AD5206BRUZ10-RL7	-40°C to +85°C	24-Lead TSSOP	Reel, 1000	RU-24
AD5206BRUZ50	-40°C to +85°C	24-Lead TSSOP	Tube	RU-24
AD5206BRUZ50-REEL7	-40°C to +85°C	24-Lead TSSOP	Reel, 1000	RU-24
AD5206BRZ10	-40°C to +85°C	24-Lead SOIC (Wide)	Tube	RW-24
AD5206BRZ100	-40°C to +85°C	24-Lead SOIC (Wide)	Tube	RW-24
AD5206BRZ10-REEL	-40°C to +85°C	24-Lead SOIC (Wide)	Reel, 1000	RW-24
AD5206BRZ50	-40°C to +85°C	24-Lead SOIC (Wide)	Tube	RW-24

<sup>1</sup> Z = RoHS Compliant Part.

## EVALUATION BOARDS

Model	Description
EVAL-AD5204SDZ <sup>1</sup>	Evaluation Board

<sup>1</sup> Z = RoHS Compliant Part.

## Looking for pricing, stock, or lifecycle information?

Click below to explore more details on WIN SOURCE:

 [View AD5204BR10 on WIN SOURCE](#)

 [Analog Devices Inc. Information](#)

## Optimize Your Supply Chain with WIN SOURCE Solutions

-  Global Sourcing Solution
-  Obsolete Management
-  Cost Control Management
-  Shortage Management
-  Alternative Solution
-  Excess Inventory Management