



THE DATASHEET OF PLC-30-48



■ Features :

- Universal AC input / Full range
- Adjustable output voltage and current level
- Protections: Short circuit / Over current / Over voltage / Over temperature
- Cooling by free air convection
- Built-in constant current limiting circuit
- Fully isolated plastic case with terminal block style of I/O
- Built-in active PFC function, comply with BS EN/EN61000-3-2 class C (Pin \geq 25W)
- Class II power unit, no FG
- Class 2 power unit
- 100% full load burn-in test
- High reliability
- Suitable for LED lighting and moving sign applications (Note.2)
- Compliance to worldwide safety regulations for lighting
- 2 years warranty

User's Manual



■ GTIN CODE

MW Search: <https://www.meanwell.com/serviceGTIN.aspx>



SPECIFICATION

MODEL	PLC-30-9	PLC-30-12	PLC-30-15	PLC-30-20	PLC-30-24	PLC-30-27	PLC-30-36	PLC-30-48		
OUTPUT	DC VOLTAGE	9V	12V	15V	20V	24V	27V	36V	48V	
	CONSTANT CURRENT REGION Note.6	6.3 ~ 9V	8.4 ~ 12V	10.5 ~ 15V	14 ~ 20V	16.8 ~ 24V	18.9 ~ 27V	25.2 ~ 36V	33.6 ~ 48V	
	RATED CURRENT	3.3A	2.5A	2A	1.5A	1.25A	1.12A	0.84A	0.63A	
	CURRENT RANGE	0 ~ 3.3A	0 ~ 2.5A	0 ~ 2A	0 ~ 1.5A	0 ~ 1.25A	0 ~ 1.12A	0 ~ 0.84A	0 ~ 0.63A	
	RATED POWER	29.7W	30W	30W	30W	30W	30.24W	30.24W	30.24W	
	RIPPLE & NOISE (max.) Note.2	2.6Vp-p	2Vp-p	2.6Vp-p	2.6Vp-p	2.4Vp-p	2.3Vp-p	3.6Vp-p	3.7Vp-p	
	VOLTAGE ADJ. RANGE Note.5	8.55 ~ 9.9V	11.4 ~ 13.2V	14.5 ~ 16.5V	19 ~ 22V	22.8 ~ 26.4V	25.65 ~ 29.7V	34.2 ~ 39.6V	45.6 ~ 52.8V	
	CURRENT ADJ. RANGE Note.5	2.475 ~ 3.399A	1.875 ~ 2.575A	1.5 ~ 2.06A	1.125 ~ 1.545A	0.938 ~ 1.288A	0.84 ~ 1.1536A	0.63 ~ 0.865A	0.473 ~ 0.649A	
	VOLTAGE TOLERANCE Note.3	±10%								
	LINE REGULATION	±3.0%								
LOAD REGULATION	±5.0%									
SETUP TIME	500ms / 230VAC 3000ms / 115VAC at full load									
INPUT	VOLTAGE RANGE Note.4	90 ~ 264VAC 127 ~ 370VDC								
	FREQUENCY RANGE	47 ~ 63Hz								
	POWER FACTOR (Typ.)	PF>0.95/115VAC, PF>0.9/230VAC at full load (Please refer to "Power Factor Characteristic" curve)								
	TOTAL HARMONIC DISTORTION	THD< 20% when output loading \geq 70% at 115VAC/230VAC input								
	EFFICIENCY (Typ.)	80%	82.5%	83.5%	84%	84%	84.5%	85%	85.5%	
	AC CURRENT (Typ.)	0.4A/115VAC 0.2A/230VAC								
	INRUSH CURRENT (Typ.)	COLD START 35A(twidth=25 μ s measured at 50% Ipeak) at 230VAC								
	MAX. No. of PSUs on 16A CIRCUIT BREAKER	64 units (circuit breaker of type B) / 64 units (circuit breaker of type C) at 230VAC								
LEAKAGE CURRENT	<0.5mA / 240VAC									
PROTECTION	OVER CURRENT	100 ~ 110% Protection type : Constant current limiting, recovers automatically after fault condition is removed								
	SHORT CIRCUIT	Hiccup mode, recovers automatically after fault condition is removed.								
	OVER VOLTAGE	10 ~ 14V	14 ~ 17V	17 ~ 22V	23 ~ 26V	27 ~ 34V	31 ~ 35V	40 ~ 50V	53 ~ 63V	
	OVER TEMPERATURE	Shut down o/p voltage, re-power on to recover								
ENVIRONMENT	WORKING TEMP.	-30 ~ +50 $^{\circ}$ C (Refer to "Derating Curve")								
	WORKING HUMIDITY	20 ~ 95% RH non-condensing								
	STORAGE TEMP., HUMIDITY	-40 ~ +80 $^{\circ}$ C, 10 ~ 95% RH								
	TEMP. COEFFICIENT	±0.06%/ $^{\circ}$ C (0 ~ 50 $^{\circ}$ C)								
VIBRATION	10 ~ 500Hz, 2G 12min./1cycle, period for 72min. each along X, Y, Z axes									
SAFETY & EMC	SAFETY STANDARDS	UL1310, TUV BS EN/EN61347-1, BS EN/EN61347-2-13, GB19510.14,GB19510.1, CAN/CSA C22.2 No. 223-M91(except for 48V), EAC TP TC 004 approved								
	WITHSTAND VOLTAGE	I/P-O/P:3.75KVAC								
	ISOLATION RESISTANCE	I/P-O/P:100M Ohms / 500VDC / 25 $^{\circ}$ C/ 70% RH								
	EMC EMISSION	Compliance to BS EN/EN55015, GB/T 17743, GB17625.1,BS EN/EN61000-3-2 Class C (Pin \geq 25W), Class D (>70% load) ; BS EN/EN61000-3-3,EAC TP TC 020								
	EMC IMMUNITY	Compliance to BS EN/EN61000-4-2,3,4,5,6,8,11, BS EN/EN55024, BS EN/EN61547, light industry level, EAC TP TC 020								
OTHERS	MTBF	4293.1K hrs min. Telcordia SR-332 (Bellcore)		625.5Khrs min.		MIL-HDBK-217F (25 $^{\circ}$ C)				
	DIMENSION	160*46*30mm (L*W*H)								
	PACKING	0.2Kg; 70pcs/15Kg/0.96CUFT								

NOTE

- All parameters NOT specially mentioned are measured at 230VAC input, rated load and 25 $^{\circ}$ C of ambient temperature.
- Ripple & noise are measured at 20MHz of bandwidth by using a 12" twisted pair-wire terminated with a 0.1 μ f & 47 μ f parallel capacitor.
- Tolerance : includes set up tolerance, line regulation and load regulation.
- Derating may be needed under low input voltage. Please check the static characteristics for more details.
- Output voltage can be adjusted through the SVR1 on the PCB; limit of output constant current level can be adjusted through the SVR2 on the PCB.
- Please refer to "DRIVING METHODS OF LED MODULE".
- The power supply is considered as a component that will be operated in combination with final equipment. Since EMC performance will be affected by the complete installation, the final equipment manufacturers must re-qualify EMC Directive on the complete installation again. (as available on https://www.meanwell.com/Upload/PDF/EMI_statement_en.pdf)
- Direct connecting to LEDs is suggested, but is not suitable for using additional drivers.
- To fulfill requirements of the latest ErP regulation for lighting fixtures, this LED power supply can only be used behind a switch without permanently connected to the mains.
- The ambient temperature derating of 3.5 $^{\circ}$ C/1000m with fanless models and of 5 $^{\circ}$ C/1000m with fan models for operating altitude higher than 2000m(6500ft).
- PLC-30-9 is used for any light source that exempt from the ErP-Directive (EU) 2019/2020 requirement, for example this model could be use for signalling products (including, but not limited to road-, railway-, marineair traffic-signalling , traffic control or airfield lamps).

⊗ Product Liability Disclaimer : For detailed information, please refer to <https://www.meanwell.com/serviceDisclaimer.aspx>

■ Mechanical Specification

Case No. 990A Unit:mm

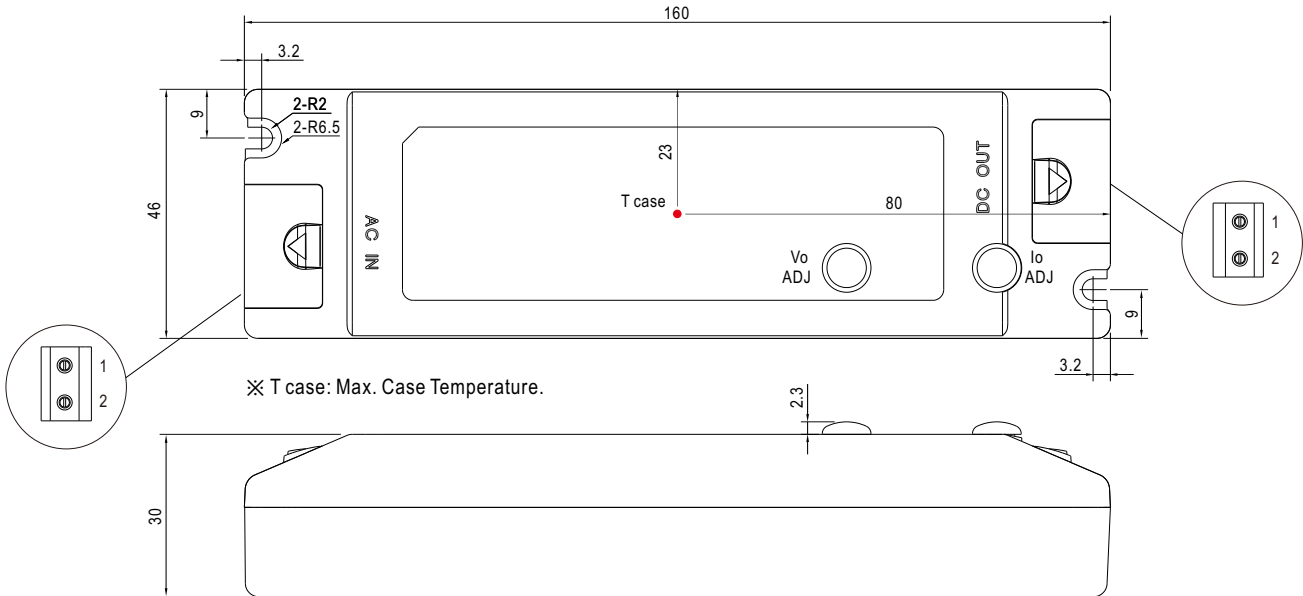

※ T case: Max. Case Temperature.

Terminal Pin No. Assignment (TB1):
SWITCHLAB MB310-75002

Pin No.	Assignment
1	AC/N
2	AC/L

Terminal Pin No. Assignment (TB2):
SWITCHLAB MB310-75002

Pin No.	Assignment
1	+V
2	-V

■ Block Diagram

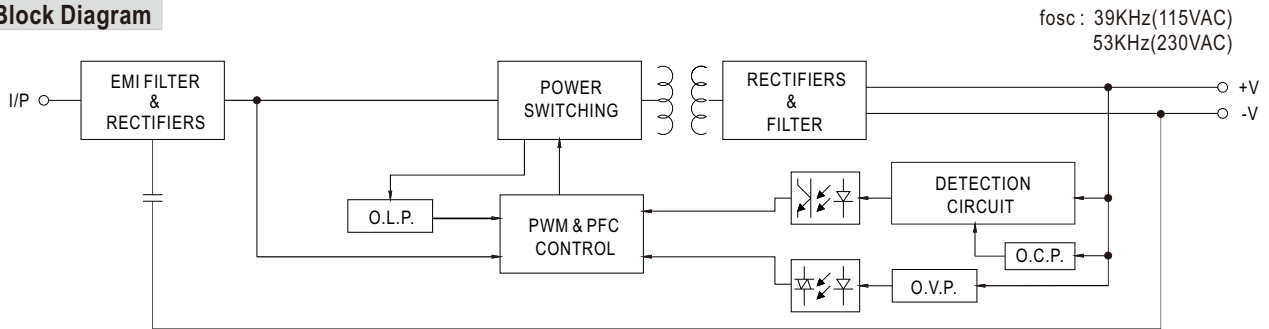

■ Derating Curve

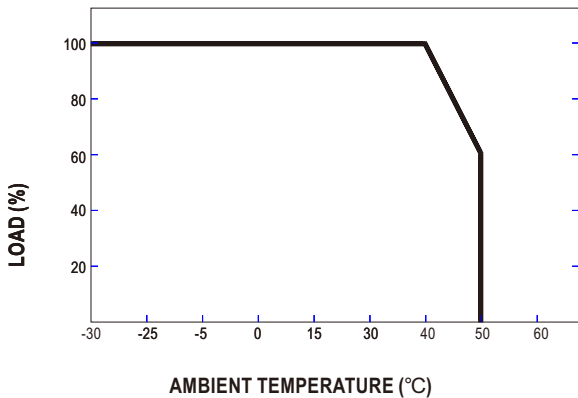

■ Static Characteristics

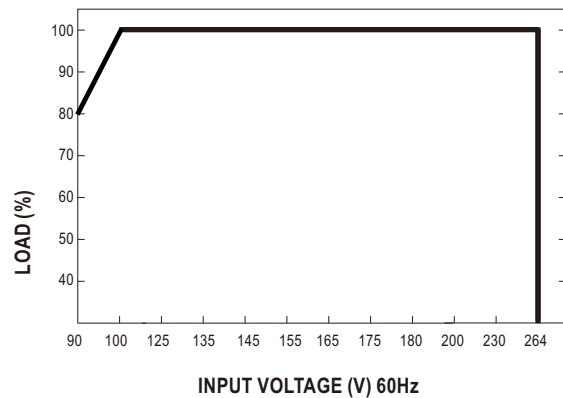

Power Factor Characteristic

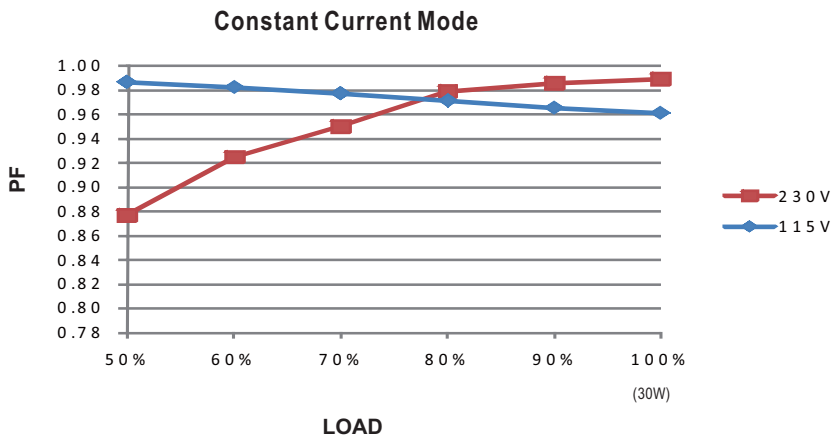

EFFICIENCY vs LOAD (48V Model)

PLC-30 series possess superior working efficiency that up to 85.5% can be reached in field applications.

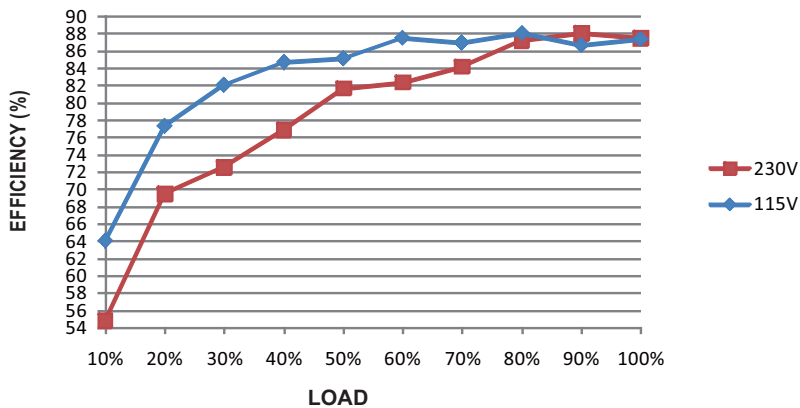

DRIVING METHODS OF LED MODULE

This LED power supply is suggested to work in constant current mode area (CC) to drive the LEDs.

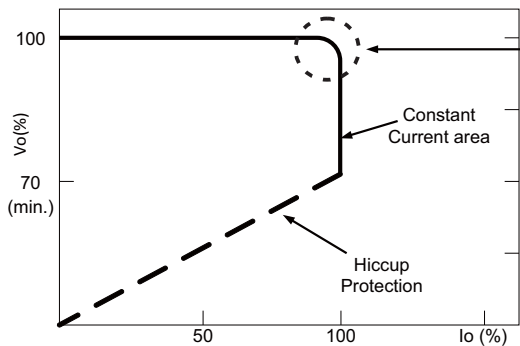



Typical LED power supply I-V curve

In the constant current region, the highest voltage at the output of the driver depends on the configuration of the end systems.
Should there be any compatibility issues, please contact MEAN WELL.

Looking for pricing, stock, or lifecycle information?

Click below to explore more details on WIN SOURCE:

-  [View PLC-30-48 on WIN SOURCE](#)
-  [Mean Well Enterprises Co., Ltd. Information](#)

Optimize Your Supply Chain with WIN SOURCE Solutions

-  Global Sourcing Solution
-  Obsolete Management
-  Cost Control Management
-  Shortage Management
-  Alternative Solution
-  Excess Inventory Management