



**THE DATASHEET OF  
NBPDANN100PAUNV**



# BASIC BOARD MOUNT PRESSURE SENSORS

32307741  
Issue D

## TBP Series: Compensated/Unamplified

60 mbar to 10 bar | 6 kPa to 1 MPa | 1 psi to 150 psi,  
Millivolt Analog Output

## NBP Series: Uncompensated/Unamplified

60 mbar to 10 bar | 1 psi to 150 psi,  
Millivolt Analog Output

### DESCRIPTION

Honeywell's Basic Board Mount Pressure Sensors, TBP Series and NBP Series, are designed for food grade and non-food grade potential medical and industrial applications. These unamplified, piezoresistive silicon pressure sensors provide a ratiometric output and are either temperature compensated (TBP Series) or uncompensated (NBP Series).

#### TBP Series:

- Temperature compensated and unamplified.
- Compensation makes it easier to integrate the sensor into a system by minimizing the need to calibrate the system over temperature on a regular basis; offers reduced part-to-part variation.
- Offers multitude of resolutions of the pressure signal.
- Compensated temperature range is 0°C to 85°C [-32°F to 185°F].

#### NBP Series:

- Uncompensated and unamplified.
- Is often ideal for customers who want to do their own compensation, calibration and amplification in order to make use of the maximum resolution of the bare sensor output, leveraging any algorithm needed for the application.
- Offers multitude of resolutions of the pressure signal.

These products are available in numerous package styles and mounting options, making it easier for device manufacturers to integrate the product into their applications. They are intended for use with non-corrosive, non-ionic gases, such as air and other dry gases, and for non-corrosive, non-ionic liquids when the silicone gel coating option is selected. All products are designed and manufactured according to ISO 9001 and are NSF certified. Specific configurations are food grade certified. Consult the factory for food grade options.

### VALUE TO CUSTOMERS

- Cost-competitive pressure sensing solution
- Smaller when compared to many

similar products, occupying less space on the printed circuit board (PCB) and typically allowing for easier placement on PCBs or in small devices

- Performs in many tough environments with dry and wetted media
- Numerous options simplify integration into the device manufacturer's application
- Food Safety Certification for North America, Europe and Asia

### FEATURES

- Package size as small as 7 mm x 7 mm [0.276 in x 0.276 in]
- Operating temperature range -40°C to 125°C [-40°F to 257°F]
- Reflow mounting J-STD-020E, MSL 1 and rapid stabilization after reflow soldering allow calibration immediately after mounting
- Media compatibility options:
  - **No gel coating in media path:** Input port is limited to non-corrosive, non-ionic media such as dry air and gases and should not be exposed to condensation; gases are limited to media that are compatible with high temperature polyamide, silicone, alumina ceramic, silicon, gold and glass
  - **Silicone gel coating in media path:** Uses the same materials in the wetted media path but is protected from condensation by a silicone-based gel coating; allows for use in applications where condensation can occur
- For selective configurations, sensor materials have been tested and certified for these food safety standards (applies to specific configurations only):
  - NSF-169
  - BPA Free
  - LFGB

### POTENTIAL APPLICATIONS

- **Medical:** Blood pressure monitoring, hospital beds, oxygen concentrators, wound therapy
- **Industrial:** Air movement control, environmental control, HVAC transmitters, industrial controls, leak detection, other commercial applications, pneumatic controls, food and beverage



### PORTFOLIO

Honeywell offers a variety of board mount pressure sensors for use in potential medical and industrial applications. To view the entire product portfolio, [click here.](#)



**Honeywell**

# TBP SERIES AND NBP SERIES BASIC BOARD MOUNT PRESSURE SENSORS

## TABLE OF CONTENTS

TBP Series and NBP Series General Specifications .....	2-3
TBP Series Nomenclature and Order Guide .....	4
NBP Series Nomenclature and Order Guide .....	5
<b>TBP Series Pressure Range Specifications:</b>	
60 mbar to 10 bar .....	6
6 kPa to 1 MPa .....	7
1 psi to 150 psi .....	8
<b>NBP Series Pressure Range Specifications:</b>	
60 mbar to 10 bar .....	9
1 psi to 150 psi .....	10
<b>Dimensional Drawings:</b>	
DIP Packages .....	11-14
SMT Packages .....	14-16
Leadless SMT Packages .....	16-17
<b>Food Grade Regulations</b> .....	18
<b>Additional Information</b> .....	back cover

**TABLE 1. OPERATING SPECIFICATIONS**

CHARACTERISTIC	MIN.	TYP.	MAX.	UNIT
<b>TBP SERIES</b>				
Supply voltage ( $V_{\text{supply}}$ ) <sup>1,2</sup>	1.5	5.0	12.0	Vdc
Supply current (at 5.0 Vdc supply)	–	0.6	1	mA
Operating temperature range <sup>3</sup>	-40 [-40]	–	125 [257]	°C [°F]
Compensated temperature range <sup>4</sup>	0 [32]	–	85 [185]	°C [°F]
Output resistance	–	2.5	–	kOhm
<b>NBP SERIES</b>				
Supply voltage ( $V_{\text{supply}}$ ) <sup>1,2</sup>	1.8	5.0	12.0	Vdc
Supply current (at 5.0 Vdc supply)	–	1.5	2.5	mA
Specified temperature range <sup>5</sup>	-40 [-40]	–	125 [257]	°C [°F]
Accuracy <sup>6</sup>	–	–	±0.25	%FSS BFSL <sup>7</sup>
Input resistance	2.4	3.0	5.5	kOhm
Thermal effect on resistance (TER) <sup>8</sup>	1200	–	3200	ppm/°C

<sup>1</sup>Ratiometricity of the sensor (the ability of the device output to scale to the supply voltage) is achieved within the specified operating voltage.

<sup>2</sup>Incorrect application of supply voltage or ground to the wrong pin may cause electrical failure.

<sup>3</sup>**Operating temperature range:** The temperature range over which the sensor produces an output proportional to pressure.

<sup>4</sup>**Compensated temperature range:** The temperature range over which the sensor produces an output proportional to pressure within the specified performance limits.

<sup>5</sup>**Specified temperature range:** The temperature range over which the sensor will produce an output proportional to pressure within the specified performance limits.

<sup>6</sup>**Accuracy:** The maximum deviation in output from a Best Fit Straight Line (BFSL) fitted to the output measured over the pressure range at 25°C [77°F]. Includes all errors due to pressure non-linearity, pressure hysteresis, and non-repeatability.

<sup>7</sup>**Full Scale Span (FSS):** The algebraic difference between the output signal measured at the maximum and minimum limits of the pressure range. (See Figure 2 for pressure ranges.)

<sup>8</sup>**TER (Thermal Effect on Resistance):** The deviation in input resistance due to change in temperature over the specified temperature range, relative to input resistance measured at 25°C [77°F].

**TABLE 2. PRESSURE REFERENCE TYPES**

PRESSURE TYPE	DESCRIPTION
Absolute	Output is proportional to the difference between applied pressure and a built-in reference to vacuum. Reference pressure is absolute zero pressure (full vacuum).
Differential	Output is proportional to the difference between the pressures applied to each port (Port 1 - Port 2).
Gage	Output is proportional to the difference between applied pressure and atmospheric (ambient) pressure. Reference pressure is atmospheric pressure.

# TBP SERIES AND NBP SERIES BASIC BOARD MOUNT PRESSURE SENSORS

**TABLE 3. ABSOLUTE MAXIMUM RATINGS<sup>1</sup>**

CHARACTERISTIC	MIN.	MAX.	UNIT
Supply voltage ( $V_{\text{supply}}$ )	-12.0	12.0	Vdc
Storage temperature	-40 [-40]	125 [257]	°C [°F]
Soldering time and temperature: lead solder temperature (DIP) peak reflow temperature (SMT, Leadless SMT)		4 s max. at 250°C [482°F] 15 s max. at 250°C [482°F]	

<sup>1</sup>Absolute maximum ratings are the extreme limits the device will withstand without damage.

**TABLE 4. ENVIRONMENTAL SPECIFICATIONS**

CHARACTERISTIC	PARAMETER
Humidity: all external surfaces internal surfaces of silicone gel coating option internal surfaces of no gel coating option	0 %RH to 95 %RH, non-condensing 0 %RH to 100 %RH, condensing 0 %RH to 95 %RH, non-condensing
Vibration	MIL-STD-202G, Method 204D, Condition B (15 g, 10 Hz to 2 kHz)
Shock	MIL-STD-202G, Method 213B, Condition C (100 g, 6 ms duration)
Life <sup>1</sup>	1 million pressure cycles min.
ESD	MIL-STD-883 Method 3015.7
Solder reflow	J-STD-020E, MSL 1, unlimited storage life
Certification (silicone gel coating option: Port 1 only)	NSF- 169, BPA Free, LFGB

<sup>1</sup>Life may vary depending on specific application in which the sensor is utilized.

**TABLE 5. WETTED MATERIALS<sup>1</sup>**

COMPONENT	PRESSURE PORT 1 (P1)		PRESSURE PORT 2 (P2)
	NO GEL COATING IN MEDIA PATH	SILICONE GEL COATING IN MEDIA PATH (FOOD GRADE)	
Ports and covers	high temperature polyamide		
Substrate	alumina ceramic	–	alumina ceramic
Adhesives	epoxy, silicone	epoxy, silicone gel	epoxy, silicone
Electronic components	silicon, gold, glass, solder, aluminum	304SST	silicon

<sup>1</sup>Contact Honeywell Customer Service for detailed material information.

## CAUTION MISUSE OF GEL COATING OPTION

- **No gel coating in media path:** The input port is limited to non-corrosive, non-ionic media such as dry air and gases and should not be exposed to condensation. The gases are limited to media which are compatible with the following wetted materials of construction: high temperature polyamide, silicone, alumina ceramic, silicon, gold, and glass.
- **Silicone gel coating in media path:** The gel coated sensors use the same materials in the wetted media path but are protected from condensation by a silicone-based gel coating. The gel coating option allows use in applications where condensation can occur.

**Failure to comply with these instructions may result in product damage.**

# TBP SERIES AND NBP SERIES BASIC BOARD MOUNT PRESSURE SENSORS

**FIGURE 1. TBP SERIES NOMENCLATURE AND ORDER GUIDE (PART ORDER QUANTITY MUST MEET MOQ REQUIREMENTS.)**























For example, **TBPDANN150PGUCV** defines a TBP Series Basic Board Mount Pressure Sensor, DIP package, AN pressure port, no gel coating in media path, 150 psi gage pressure range, unamplified, compensated, constant supply voltage.

**TBP D AN N 150PG U C V**

**Series**  
**TBP**

**Package**  
**L** Leadless SMT (Surface Mount Technology)  
**M** SMT (Surface Mount Technology)  
**D** DIP (Dual Inline Pin)

**Pressure Port**

Leadless SMT	SMT	DIP
<b>AN</b> Single axial small barbed port <sup>3</sup> 	<b>AN</b> Single axial small barbed port <sup>3</sup> 	<b>AN</b> Single axial small barbed port <sup>3</sup> 
-	-	<b>JJ</b> Dual radial barbless port 
<b>JN</b> Single radial barbless port 	<b>JN</b> Single radial barbless port 	<b>JN</b> Single radial barbless port 
<b>KN</b> Single axial large barbed port 	<b>KN</b> Single axial large barbed port 	<b>KN</b> Single axial large barbed port 
<b>LN</b> Single axial barbless port <sup>3</sup> 	<b>LN</b> Single axial barbless port <sup>3</sup> 	<b>LN</b> Single axial barbless port <sup>3</sup> 
<b>PN</b> Low-profile port 	<b>PN</b> Low-profile port 	<b>PN</b> Low-profile port 
<b>RN</b> Single radial barbed port 	<b>RN</b> Single radial barbed port 	<b>RN</b> Single radial barbed port 
-	-	<b>RR</b> Dual radial barbed port 
<b>VN</b> Single axial barbless straight port 	<b>VN</b> Single axial barbless straight port 	<b>VN</b> Single axial barbless straight port 

**Supply Voltage**  
**V** Constant

**Compensation**  
**C** Compensated

**Output**  
**U** Unamplified

**Pressure Range<sup>1,2</sup>**

60 mbar to 10 bar <i>Gage</i>		6 kPa to 1 MPa <i>Gage</i>		1 psi to 150 psi <i>Gage</i>	
<b>060MG</b>	0 mbar to 60 mbar	<b>006KG</b>	0 kPa to 6 kPa	<b>001PG</b>	0 psi to 1 psi
<b>100MG</b>	0 mbar to 100 mbar	<b>010KG</b>	0 kPa to 10 kPa	<b>005PG</b>	0 psi to 5 psi
<b>160MG</b>	0 mbar to 160 mbar	<b>016KG</b>	0 kPa to 16 kPa	<b>015PG</b>	0 psi to 15 psi
<b>250MG</b>	0 mbar to 250 mbar	<b>025KG</b>	0 kPa to 25 kPa	<b>030PG</b>	0 psi to 30 psi
<b>400MG</b>	0 bar to 400 mbar	<b>040KG</b>	0 kPa to 40 kPa	<b>060PG</b>	0 psi to 60 psi
<b>600MG</b>	0 bar to 600 mbar	<b>060KG</b>	0 kPa to 60 kPa	<b>100PG</b>	0 psi to 100 psi
<b>001BG</b>	0 bar to 1 bar	<b>100KG</b>	0 kPa to 100 kPa	<b>150PG</b>	0 psi to 150 psi
<b>1.6BG</b>	0 bar to 1.6 bar	<b>160KG</b>	0 kPa to 160 kPa		
<b>2.5BG</b>	0 bar to 2.5 bar	<b>250KG</b>	0 kPa to 250 kPa		
<b>004BG</b>	0 bar to 4 bar	<b>400KG</b>	0 kPa to 400 kPa		
<b>006BG</b>	0 bar to 6 bar	<b>600KG</b>	0 kPa to 600 kPa		
<b>010BG</b>	0 bar to 10 bar	<b>001GG</b>	0 kPa to 1 MPa		

<i>Differential</i>		<i>Differential</i>		<i>Differential</i>	
<b>060MD</b>	±60 mbar	<b>006KD</b>	±6 kPa	<b>001PD</b>	±1 psi
<b>100MD</b>	±100 mbar	<b>010KD</b>	±10 kPa	<b>005PD</b>	±5 psi
<b>160MD</b>	±160 mbar	<b>016KD</b>	±16 kPa	<b>015PD</b>	±15 psi
<b>250MD</b>	±250 mbar	<b>025KD</b>	±25 kPa	<b>030PD</b>	±30 psi
<b>400MD</b>	±400 mbar	<b>040KD</b>	±40 kPa	<b>060PD</b>	±60 psi
<b>600MD</b>	±600 mbar	<b>060KD</b>	±60 kPa		
<b>001BD</b>	±1 bar	<b>100KD</b>	±100 kPa		
<b>1.6BD</b>	±1.6 bar	<b>160KD</b>	±160 kPa		
<b>2.5BD</b>	±2.5 bar	<b>250KD</b>	±250 kPa		
<b>004BD</b>	±4 bar	<b>400KD</b>	±400 kPa		

**Gel Coating**  
**N** No gel coating in media path  
**S** Silicone gel coating in media path (food grade)

<sup>1</sup>Custom pressure ranges are available. Contact Honeywell Customer Service for more information.

<sup>2</sup>See Table 2 for an explanation of pressure types.

<sup>3</sup>These configurations have food grade compatible material.

# TBP SERIES AND NBP SERIES BASIC BOARD MOUNT PRESSURE SENSORS

**FIGURE 2. NBP SERIES NOMENCLATURE AND ORDER GUIDE (PART ORDER QUANTITY MUST MEET MOQ REQUIREMENTS.)**

For example, **NBPDANN150PGUNV** defines an NBP Series Basic Board Mount Pressure Sensor, DIP package, AN pressure port, no gel coating in media path, 150 psi gage pressure range, unamplified, uncompensated, constant supply voltage.

**NBP D AN N 150PG U N V**

<b>Series</b> <b>NBP</b>				<b>Supply Voltage</b> <b>V</b> Constant																																																																																																																
<b>Package</b> <b>L</b> Leadless SMT (Surface Mount Technology) <b>M</b> SMT (Surface Mount Technology) <b>D</b> DIP (Dual Inline Pin)				<b>Compensation</b> <b>N</b> Uncompensated																																																																																																																
<b>Pressure Port</b>	<b>Leadless SMT</b>	<b>SMT</b>	<b>DIP</b>	<b>Output</b> <b>U</b> Unamplified																																																																																																																
<b>AN</b> Single axial small barbed port <sup>3</sup>	<b>AN</b> Single axial small barbed port <sup>3</sup>	<b>AN</b> Single axial small barbed port <sup>3</sup>		<b>Pressure Range<sup>1,2</sup></b> 60 mbar to 10 bar <i>Absolute</i> <table border="1"> <tr><td><b>001BA</b></td><td>0 bar to 1 bar</td><td><b>015PA</b></td><td>0 psi to 15 psi</td></tr> <tr><td><b>1.6BA</b></td><td>0 bar to 1.6 bar</td><td><b>030PA</b></td><td>0 psi to 30 psi</td></tr> <tr><td><b>2.5BA</b></td><td>0 bar to 2.5 bar</td><td><b>060PA</b></td><td>0 psi to 60 psi</td></tr> <tr><td><b>004BA</b></td><td>0 bar to 4 bar</td><td><b>100PA</b></td><td>0 psi to 100 psi</td></tr> <tr><td><b>006BA</b></td><td>0 bar to 6 bar</td><td><b>150PA</b></td><td>0 psi to 150 psi</td></tr> <tr><td><b>010BA</b></td><td>0 bar to 10 bar</td><td></td><td></td></tr> </table> <i>Gage</i> <table border="1"> <tr><td><b>060MG</b></td><td>0 mbar to 60 mbar</td><td><b>001PG</b></td><td>0 psi to 1 psi</td></tr> <tr><td><b>100MG</b></td><td>0 mbar to 100 mbar</td><td><b>005PG</b></td><td>0 psi to 5 psi</td></tr> <tr><td><b>160MG</b></td><td>0 mbar to 160 mbar</td><td><b>015PG</b></td><td>0 psi to 15 psi</td></tr> <tr><td><b>250MG</b></td><td>0 mbar to 250 mbar</td><td><b>030PG</b></td><td>0 psi to 30 psi</td></tr> <tr><td><b>400MG</b></td><td>0 bar to 400 mbar</td><td><b>060PG</b></td><td>0 psi to 60 psi</td></tr> <tr><td><b>600MG</b></td><td>0 bar to 600 mbar</td><td><b>100PG</b></td><td>0 psi to 100 psi</td></tr> <tr><td><b>001BG</b></td><td>0 bar to 1 bar</td><td><b>150PG</b></td><td>0 psi to 150 psi</td></tr> <tr><td><b>1.6BG</b></td><td>0 bar to 1.6 bar</td><td></td><td></td></tr> <tr><td><b>2.5BG</b></td><td>0 bar to 2.5 bar</td><td></td><td></td></tr> <tr><td><b>004BG</b></td><td>0 bar to 4 bar</td><td></td><td></td></tr> <tr><td><b>006BG</b></td><td>0 bar to 6 bar</td><td></td><td></td></tr> <tr><td><b>010BG</b></td><td>0 bar to 10 bar</td><td></td><td></td></tr> </table> <i>Differential</i> <table border="1"> <tr><td><b>060MD</b></td><td>±60 mbar</td><td><b>001PD</b></td><td>±1 psi</td></tr> <tr><td><b>100MD</b></td><td>±100 mbar</td><td><b>005PD</b></td><td>±5 psi</td></tr> <tr><td><b>160MD</b></td><td>±160 mbar</td><td><b>015PD</b></td><td>±15 psi</td></tr> <tr><td><b>250MD</b></td><td>±250 mbar</td><td><b>030PD</b></td><td>±30 psi</td></tr> <tr><td><b>400MD</b></td><td>±400 mbar</td><td><b>060PD</b></td><td>±60 psi</td></tr> <tr><td><b>600MD</b></td><td>±600 mbar</td><td></td><td></td></tr> <tr><td><b>001BD</b></td><td>±1 bar</td><td></td><td></td></tr> <tr><td><b>1.6BD</b></td><td>±1.6 bar</td><td></td><td></td></tr> <tr><td><b>2.5BD</b></td><td>±2.5 bar</td><td></td><td></td></tr> <tr><td><b>004BD</b></td><td>±4 bar</td><td></td><td></td></tr> </table>	<b>001BA</b>	0 bar to 1 bar	<b>015PA</b>	0 psi to 15 psi	<b>1.6BA</b>	0 bar to 1.6 bar	<b>030PA</b>	0 psi to 30 psi	<b>2.5BA</b>	0 bar to 2.5 bar	<b>060PA</b>	0 psi to 60 psi	<b>004BA</b>	0 bar to 4 bar	<b>100PA</b>	0 psi to 100 psi	<b>006BA</b>	0 bar to 6 bar	<b>150PA</b>	0 psi to 150 psi	<b>010BA</b>	0 bar to 10 bar			<b>060MG</b>	0 mbar to 60 mbar	<b>001PG</b>	0 psi to 1 psi	<b>100MG</b>	0 mbar to 100 mbar	<b>005PG</b>	0 psi to 5 psi	<b>160MG</b>	0 mbar to 160 mbar	<b>015PG</b>	0 psi to 15 psi	<b>250MG</b>	0 mbar to 250 mbar	<b>030PG</b>	0 psi to 30 psi	<b>400MG</b>	0 bar to 400 mbar	<b>060PG</b>	0 psi to 60 psi	<b>600MG</b>	0 bar to 600 mbar	<b>100PG</b>	0 psi to 100 psi	<b>001BG</b>	0 bar to 1 bar	<b>150PG</b>	0 psi to 150 psi	<b>1.6BG</b>	0 bar to 1.6 bar			<b>2.5BG</b>	0 bar to 2.5 bar			<b>004BG</b>	0 bar to 4 bar			<b>006BG</b>	0 bar to 6 bar			<b>010BG</b>	0 bar to 10 bar			<b>060MD</b>	±60 mbar	<b>001PD</b>	±1 psi	<b>100MD</b>	±100 mbar	<b>005PD</b>	±5 psi	<b>160MD</b>	±160 mbar	<b>015PD</b>	±15 psi	<b>250MD</b>	±250 mbar	<b>030PD</b>	±30 psi	<b>400MD</b>	±400 mbar	<b>060PD</b>	±60 psi	<b>600MD</b>	±600 mbar			<b>001BD</b>	±1 bar			<b>1.6BD</b>	±1.6 bar			<b>2.5BD</b>	±2.5 bar			<b>004BD</b>	±4 bar		
<b>001BA</b>	0 bar to 1 bar	<b>015PA</b>	0 psi to 15 psi																																																																																																																	
<b>1.6BA</b>	0 bar to 1.6 bar	<b>030PA</b>	0 psi to 30 psi																																																																																																																	
<b>2.5BA</b>	0 bar to 2.5 bar	<b>060PA</b>	0 psi to 60 psi																																																																																																																	
<b>004BA</b>	0 bar to 4 bar	<b>100PA</b>	0 psi to 100 psi																																																																																																																	
<b>006BA</b>	0 bar to 6 bar	<b>150PA</b>	0 psi to 150 psi																																																																																																																	
<b>010BA</b>	0 bar to 10 bar																																																																																																																			
<b>060MG</b>	0 mbar to 60 mbar	<b>001PG</b>	0 psi to 1 psi																																																																																																																	
<b>100MG</b>	0 mbar to 100 mbar	<b>005PG</b>	0 psi to 5 psi																																																																																																																	
<b>160MG</b>	0 mbar to 160 mbar	<b>015PG</b>	0 psi to 15 psi																																																																																																																	
<b>250MG</b>	0 mbar to 250 mbar	<b>030PG</b>	0 psi to 30 psi																																																																																																																	
<b>400MG</b>	0 bar to 400 mbar	<b>060PG</b>	0 psi to 60 psi																																																																																																																	
<b>600MG</b>	0 bar to 600 mbar	<b>100PG</b>	0 psi to 100 psi																																																																																																																	
<b>001BG</b>	0 bar to 1 bar	<b>150PG</b>	0 psi to 150 psi																																																																																																																	
<b>1.6BG</b>	0 bar to 1.6 bar																																																																																																																			
<b>2.5BG</b>	0 bar to 2.5 bar																																																																																																																			
<b>004BG</b>	0 bar to 4 bar																																																																																																																			
<b>006BG</b>	0 bar to 6 bar																																																																																																																			
<b>010BG</b>	0 bar to 10 bar																																																																																																																			
<b>060MD</b>	±60 mbar	<b>001PD</b>	±1 psi																																																																																																																	
<b>100MD</b>	±100 mbar	<b>005PD</b>	±5 psi																																																																																																																	
<b>160MD</b>	±160 mbar	<b>015PD</b>	±15 psi																																																																																																																	
<b>250MD</b>	±250 mbar	<b>030PD</b>	±30 psi																																																																																																																	
<b>400MD</b>	±400 mbar	<b>060PD</b>	±60 psi																																																																																																																	
<b>600MD</b>	±600 mbar																																																																																																																			
<b>001BD</b>	±1 bar																																																																																																																			
<b>1.6BD</b>	±1.6 bar																																																																																																																			
<b>2.5BD</b>	±2.5 bar																																																																																																																			
<b>004BD</b>	±4 bar																																																																																																																			
-	-	<b>JJ</b> Dual radial barbless port																																																																																																																		
<b>JN</b> Single radial barbless port	<b>JN</b> Single radial barbless port	<b>JN</b> Single radial barbless port																																																																																																																		
<b>KN</b> Single axial large barbed port	<b>KN</b> Single axial large barbed port	<b>KN</b> Single axial large barbed port																																																																																																																		
<b>LN</b> Single axial barbless port <sup>3</sup>	<b>LN</b> Single axial barbless port <sup>3</sup>	<b>LN</b> Single axial barbless port <sup>3</sup>																																																																																																																		
<b>PN</b> Low-profile port	<b>PN</b> Low-profile port	<b>PN</b> Low-profile port																																																																																																																		
<b>RN</b> Single radial barbed port	<b>RN</b> Single radial barbed port	<b>RN</b> Single radial barbed port																																																																																																																		
-	-	<b>RR</b> Dual radial barbed port																																																																																																																		
<b>VN</b> Single axial barbless straight port	<b>VN</b> Single axial barbless straight port	<b>VN</b> Single axial barbless straight port																																																																																																																		

**Gel Coating**  
**N** No gel coating in media path  
**S** Silicone gel coating in media path (food grade)

<sup>1</sup>Custom pressure ranges are available. Contact Honeywell Customer Service for more information.  
<sup>2</sup>See Table 2 for an explanation of pressure types.  
<sup>3</sup>These configurations have food grade compatible material.

# TBP SERIES AND NBP SERIES BASIC BOARD MOUNT PRESSURE SENSORS

**TABLE 6. TBP SERIES PRESSURE RANGE SPECIFICATIONS FOR 60 mBAR TO 10 BAR**

Pressure Range Order Code (see Figure 1)	Pressure Range		Unit	Over-Pressure <sup>1</sup>		Burst Pressure <sup>2</sup>		Common Mode Pressure <sup>3</sup>	Pressure Accuracy (%FSS) <sup>4</sup>	Offset (mV/V) <sup>5</sup>	Full Scale Span (mV/V) <sup>6</sup>			Thermal Effect on Offset (%FSS) <sup>7</sup>		Thermal Effect on Span (%FSS) <sup>8</sup>		Long-Term Stability 1000 hr at 25°C (%FSS)	Thermal Hysteresis No Gel Option (%FSS) <sup>9</sup>	Thermal Hysteresis Silicone Gel Option (%FSS) <sup>9</sup>
	Pmin.	Pmax.		Port 1	Port 2	Port 1	Port 2				Min.	Nom.	Max.	10°C to 50°C	0°C to 85°C	10°C to 50°C	0°C to 85°C			
<b>GAGE</b>																				
060MG	0	60	mbar	872	–	1370	–	–	±0.20	±0.075	1.23	1.30	1.40	±1.15	±2.35	±1.00	±2.00	±0.45	±0.40	±0.60
100MG	0	100	mbar	872	–	1370	–	–	±0.20	±0.075	2.06	2.20	2.33	±0.70	±1.40	±1.00	±2.00	±0.30	±0.25	±0.35
160MG	0	160	mbar	2000	–	4000	–	–	±0.15	±0.12	2.18	2.30	2.46	±1.65	±3.30	±0.75	±2.00	±0.55	±0.35	±0.55
250MG	0	250	mbar	2000	–	4000	–	–	±0.15	±0.12	3.41	3.65	3.85	±1.05	±2.10	±0.75	±2.00	±0.35	±0.20	±0.35
400MG	0	400	mbar	2000	–	4000	–	–	±0.15	±0.12	5.45	5.80	6.15	±0.65	±1.30	±0.75	±2.00	±0.20	±0.15	±0.20
600MG	0	600	mbar	4000	–	8000	–	–	±0.15	±0.075	2.94	3.05	3.18	±0.85	±1.65	±0.50	±1.25	±0.40	±0.15	±0.35
001BG	0	1	bar	4	–	8	–	–	±0.15	±0.075	4.90	5.10	5.30	±0.50	±1.00	±0.50	±1.25	±0.25	±0.10	±0.20
1.6BG	0	1.6	bar	4	–	8	–	–	±0.15	±0.075	7.84	8.15	8.48	±0.30	±0.65	±0.50	±1.25	±0.15	±0.10	±0.15
2.5BG	0	2.5	bar	8	–	17	–	–	±0.15	±0.075	6.10	6.35	6.59	±0.40	±0.80	±0.50	±1.50	±0.20	±0.10	±0.15
004BG	0	4	bar	10	–	17	–	–	±0.15	±0.075	5.57	5.80	6.04	±0.50	±1.00	±0.50	±1.25	±0.25	±0.10	±0.20
006BG	0	6	bar	17	–	21	–	–	±0.15	±0.075	5.08	5.30	5.54	±0.65	±1.00	±0.50	±1.00	±0.25	±0.15	±0.25
010BG	0	10	bar	17	–	21	–	–	±0.15	±0.075	8.47	8.85	9.22	±0.40	±0.60	±0.50	±1.00	±0.15	±0.10	±0.15
<b>DIFFERENTIAL</b>																				
060MD	-60	60	mbar	872	872	1370	1370	10000	±0.20	±0.075	2.46	2.60	2.80	±0.60	±1.20	±1.00	±2.00	±0.25	±0.20	±0.30
100MD	-100	100	mbar	872	872	1370	1370	10000	±0.20	±0.075	4.12	4.40	4.66	±0.35	±0.70	±1.00	±2.00	±0.15	±0.15	±0.20
160MD	-160	160	mbar	2000	2000	4000	4000	10000	±0.15	±0.12	4.36	4.60	4.92	±0.85	±1.65	±0.75	±2.00	±0.30	±0.20	±0.30
250MD	-250	250	mbar	2000	2000	4000	4000	10000	±0.15	±0.12	6.82	7.30	7.70	±0.55	±1.05	±0.75	±2.00	±0.20	±0.10	±0.20
400MD	-400	400	mbar	2000	2000	4000	4000	10000	±0.15	±0.12	10.90	11.60	12.30	±0.35	±0.65	±0.75	±2.00	±0.10	±0.10	±0.10
600MD	-600	600	mbar	4000	4000	8000	8000	10000	±0.15	±0.075	5.88	6.10	6.36	±0.45	±0.85	±0.50	±1.25	±0.20	±0.10	±0.20
001BD	-1	1	bar	4	4	8	8	10	±0.15	±0.075	9.80	10.20	10.60	±0.25	±0.50	±0.50	±1.25	±0.15	±0.10	±0.10
1.6BD	-1.6	1.6	bar	4	4	8	8	10	±0.15	±0.075	15.68	16.30	16.96	±0.15	±0.35	±0.50	±1.25	±0.10	±0.10	±0.10
2.5BD	-2.5	2.5	bar	8	8	17	17	10	±0.15	±0.075	12.20	12.70	13.18	±0.20	±0.40	±0.50	±1.50	±0.10	±0.10	±0.10
004BD	-4	4	bar	10	10	17	17	15	±0.15	±0.075	11.14	11.60	12.08	±0.25	±0.50	±0.50	±1.25	±0.15	±0.10	±0.10

<sup>1</sup>**Overpressure:** The maximum pressure which may safely be applied to the product for it to remain within specifications once pressure is returned to the operating pressure range. Exposure to higher pressures may cause permanent damage to the product. Unless otherwise specified, this applies to all available pressure ports at any temperature within the operating temperature range.

<sup>2</sup>**Burst pressure:** The maximum pressure that may be applied to the specified port (P1 or P2) of the product without causing escape of pressure media. Product should not be expected to function after exposure to any pressure beyond the burst pressure.

<sup>3</sup>**Common mode pressure:** The maximum pressure that can be applied simultaneously to both ports of a differential pressure sensor without causing changes in specified performance.

<sup>4</sup>**Accuracy:** The maximum deviation in output from a Best Fit Straight Line (BFSL) fitted to the output measured over the pressure range at 25°C. Includes all errors due to pressure non-linearity, pressure hysteresis, and non-repeatability.

<sup>5</sup>**Offset:** The output signal obtained when the reference pressure is applied to all available pressure ports. Also known as "null" or "zero".

<sup>6</sup>**Full Scale Span:** The algebraic difference between the output signal measured at the maximum and minimum limits of the pressure range (see Figure 1) for pressure ranges).

<sup>7</sup>**Thermal effect on offset:** The deviation in offset due to changes in temperature over the compensated temperature range, relative to offset measured at 25°C.

<sup>8</sup>**Thermal effect on span:** The deviation in full scale span due to changes in temperature over the compensated temperature range, relative to full scale span measured at 25°C.

<sup>9</sup>**Thermal hysteresis:** The maximum difference between output readings when the same temperature is reached consecutively, under the same operating conditions, with temperature approaching from opposite directions within the operating temperature range. Validated over the full operating temperature and pressure ranges using a ~5°C/ minute ramp and 30 minute dwell. Application performance may be affected by thermal mass of end user system.

# TBP SERIES AND NBP SERIES BASIC BOARD MOUNT PRESSURE SENSORS

**TABLE 7. TBP SERIES PRESSURE RANGE SPECIFICATIONS FOR 6 kPa TO 1 MPa**

Pressure Range Order Code (see Figure 1)	Pressure Range		Unit	Over-Pressure <sup>1</sup>		Burst Pressure <sup>2</sup>		Common Mode Pressure <sup>3</sup>	Pressure Accuracy (%FSS) <sup>4</sup>	Offset (mV/V) <sup>5</sup>	Full Scale Span (mV/V) <sup>6</sup>			Thermal Effect on Offset (%FSS) <sup>7</sup>		Thermal Effect on Span (%FSS) <sup>8</sup>		Long-Term Stability 1000 hr at 25°C (%FSS)	Thermal Hysteresis No Gel Option (%FSS) <sup>9</sup>	Thermal Hysteresis Silicone Gel Option (%FSS) <sup>9</sup>
	Pmin.	Pmax.		Port 1	Port 2	Port 1	Port 2				Min.	Nom.	Max.	10°C to 50°C	0°C to 85°C	10°C to 50°C	0°C to 85°C			
<b>GAGE</b>																				
006KG	0	6	kPa	87	–	137	–	–	±0.20	±0.075	1.23	1.30	1.40	±1.15	±2.35	±1.00	±2.00	±0.45	±0.40	±0.60
010KG	0	10	kPa	87	–	137	–	–	±0.20	±0.075	2.06	2.20	2.33	±0.70	±1.40	±1.00	±2.00	±0.30	±0.25	±0.35
016KG	0	16	kPa	200	–	400	–	–	±0.15	±0.12	2.18	2.30	2.46	±1.65	±3.30	±0.75	±2.00	±0.55	±0.35	±0.55
025KG	0	25	kPa	200	–	400	–	–	±0.15	±0.12	3.41	3.65	3.85	±1.05	±2.10	±0.75	±2.00	±0.35	±0.20	±0.35
040KG	0	40	kPa	200	–	400	–	–	±0.15	±0.12	5.45	5.80	6.15	±0.65	±1.30	±0.75	±2.00	±0.20	±0.15	±0.20
060KG	0	60	kPa	400	–	800	–	–	±0.15	±0.075	2.94	3.05	3.18	±0.85	±1.65	±0.50	±1.25	±0.40	±0.15	±0.35
100KG	0	100	kPa	400	–	800	–	–	±0.15	±0.075	4.90	5.10	5.30	±0.50	±1.00	±0.50	±1.25	±0.25	±0.10	±0.20
160KG	0	160	kPa	400	–	800	–	–	±0.15	±0.075	7.84	8.15	8.48	±0.30	±0.65	±0.50	±1.25	±0.15	±0.10	±0.15
250KG	0	250	kPa	800	–	1700	–	–	±0.15	±0.075	6.10	6.35	6.59	±0.40	±0.80	±0.50	±1.50	±0.20	±0.10	±0.15
400KG	0	400	kPa	1000	–	1700	–	–	±0.15	±0.075	5.57	5.80	6.04	±0.50	±1.00	±0.50	±1.25	±0.25	±0.10	±0.20
600KG	0	600	kPa	1700	–	2100	–	–	±0.15	±0.075	5.08	5.30	5.54	±0.65	±1.00	±0.50	±1.00	±0.25	±0.15	±0.25
001GG	0	1	MPa	1.70	–	2.10	–	–	±0.15	±0.075	8.47	8.85	9.22	±0.40	±0.60	±0.50	±1.00	±0.15	±0.10	±0.15
<b>DIFFERENTIAL</b>																				
006KD	-6	6	kPa	87	87	137	137	1000	±0.20	±0.075	2.46	2.60	2.80	±0.60	±1.20	±1.00	±2.00	±0.25	±0.20	±0.30
010KD	-10	10	kPa	87	87	137	137	1000	±0.20	±0.075	4.12	4.40	4.66	±0.35	±0.70	±1.00	±2.00	±0.15	±0.15	±0.20
016KD	-16	16	kPa	200	200	400	400	1000	±0.15	±0.12	4.36	4.60	4.92	±0.85	±1.65	±0.75	±2.00	±0.30	±0.20	±0.30
025KD	-25	25	kPa	200	200	400	400	1000	±0.15	±0.12	6.82	7.30	7.70	±0.55	±1.05	±0.75	±2.00	±0.20	±0.10	±0.20
040KD	-40	40	kPa	200	200	400	400	1000	±0.15	±0.12	10.90	11.60	12.30	±0.35	±0.65	±0.75	±2.00	±0.10	±0.10	±0.10
060KD	-60	60	kPa	400	400	800	800	1000	±0.15	±0.075	5.88	6.10	6.36	±0.45	±0.85	±0.50	±1.25	±0.20	±0.10	±0.20
100KD	-100	100	kPa	400	400	800	800	1000	±0.15	±0.075	9.80	10.20	10.60	±0.25	±0.50	±0.50	±1.25	±0.15	±0.10	±0.10
160KD	-160	160	kPa	400	400	800	800	1000	±0.15	±0.075	15.68	16.30	16.96	±0.15	±0.35	±0.50	±1.25	±0.10	±0.10	±0.10
250KD	-250	250	kPa	800	800	1700	1700	1000	±0.15	±0.075	12.20	12.70	13.18	±0.20	±0.40	±0.50	±1.50	±0.10	±0.10	±0.10
400KD	-400	400	kPa	1000	1000	1700	1700	1500	±0.15	±0.075	11.14	11.60	12.08	±0.25	±0.50	±0.50	±1.25	±0.15	±0.10	±0.10

<sup>1</sup>**Overpressure:** The maximum pressure which may safely be applied to the product for it to remain within specifications once pressure is returned to the operating pressure range. Exposure to higher pressures may cause permanent damage to the product. Unless otherwise specified, this applies to all available pressure ports at any temperature within the operating temperature range.

<sup>2</sup>**Burst pressure:** The maximum pressure that may be applied to the specified port (P1 or P2) of the product without causing escape of pressure media. Product should not be expected to function after exposure to any pressure beyond the burst pressure.

<sup>3</sup>**Common mode pressure:** The maximum pressure that can be applied simultaneously to both ports of a differential pressure sensor without causing changes in specified performance.

<sup>4</sup>**Accuracy:** The maximum deviation in output from a Best Fit Straight Line (BFSL) fitted to the output measured over the pressure range at 25°C. Includes all errors due to pressure non-linearity, pressure hysteresis, and non-repeatability.

<sup>5</sup>**Offset:** The output signal obtained when the reference pressure is applied to all available pressure ports. Also known as “null” or “zero”.

<sup>6</sup>**Full Scale Span:** The algebraic difference between the output signal measured at the maximum and minimum limits of the pressure range (see Figure 1) for pressure ranges).

<sup>7</sup>**Thermal effect on offset:** The deviation in offset due to changes in temperature over the compensated temperature range, relative to offset measured at 25°C.

<sup>8</sup>**Thermal effect on span:** The deviation in full scale span due to changes in temperature over the compensated temperature range, relative to full scale span measured at 25°C.

<sup>9</sup>**Thermal hysteresis:** The maximum difference between output readings when the same temperature is reached consecutively, under the same operating conditions, with temperature approaching from opposite directions within the operating temperature range. Validated over the full operating temperature and pressure ranges using a ~5°C/ minute ramp and 30 minute dwell. Application performance may be affected by thermal mass of end user system.

# TBP SERIES AND NBP SERIES BASIC BOARD MOUNT PRESSURE SENSORS

**TABLE 8. TBP SERIES PRESSURE RANGE SPECIFICATIONS FOR 1 PSI TO 150 PSI**

Pressure Range Order Code (see Figure 1)	Pressure Range		Unit	Over-Pressure <sup>1</sup>		Burst Pressure <sup>2</sup>		Common Mode Pressure <sup>3</sup>	Pressure Accuracy (%FSS) <sup>4</sup>	Offset (mV/V) <sup>5</sup>	Full Scale Span (mV/V) <sup>6</sup>			Thermal Effect on Offset (%FSS) <sup>7</sup>		Thermal Effect on Span (%FSS) <sup>8</sup>		Long-Term Stability 1000 hr at 25°C (%FSS)	Thermal Hysteresis No Gel Option (%FSS) <sup>9</sup>	Thermal Hysteresis Silicone Gel Option (%FSS) <sup>9</sup>
	Pmin.	Pmax.		Port 1	Port 2	Port 1	Port 2				Min.	Nom.	Max.	10°C to 50°C	0°C to 85°C	10°C to 50°C	0°C to 85°C			
<b>GAGE</b>																				
001PG	0	1	psi	12.7	–	20	–	–	±0.20	±0.075	1.42	1.50	1.61	±1.00	±2.05	±1.00	±2.00	±0.40	±0.35	±0.50
005PG	0	5	psi	30	–	60	–	–	±0.15	±0.12	4.70	5.00	5.30	±0.75	±1.50	±0.75	±2.00	±0.25	±0.15	±0.25
015PG	0	15	psi	60	–	115	–	–	±0.15	±0.075	5.06	5.25	5.49	±0.50	±0.95	±0.50	±1.25	±0.25	±0.10	±0.20
030PG	0	30	psi	115	–	245	–	–	±0.15	±0.075	5.05	5.25	5.45	±0.50	±0.95	±0.50	±1.50	±0.25	±0.10	±0.20
060PG	0	60	psi	145	–	245	–	–	±0.15	±0.075	5.76	6.00	6.24	±0.50	±0.95	±0.50	±1.25	±0.25	±0.10	±0.20
100PG	0	100	psi	245	–	300	–	–	±0.15	±0.075	5.83	6.10	6.36	±0.60	±0.85	±0.50	±1.00	±0.25	±0.10	±0.25
150PG	0	150	psi	245	–	300	–	–	±0.15	±0.075	8.75	9.15	9.54	±0.40	±0.60	±0.50	±1.00	±0.15	±0.10	±0.15
<b>DIFFERENTIAL</b>																				
001PD	-1	1	psi	12.7	12.7	20	20	150	±0.20	±0.075	2.84	3.00	3.22	±0.50	±1.05	±1.00	±2.00	±0.20	±0.20	±0.25
005PD	-5	5	psi	30	30	60	60	150	±0.15	±0.12	9.40	10.00	10.60	±0.40	±0.75	±0.75	±2.00	±0.15	±0.10	±0.15
015PD	-15	15	psi	60	60	115	115	150	±0.15	±0.075	10.12	10.50	10.98	±0.25	±0.50	±0.50	±1.25	±0.15	±0.10	±0.10
030PD	-30	30	psi	115	115	245	245	150	±0.15	±0.075	10.10	10.50	10.90	±0.25	±0.50	±0.50	±1.50	±0.15	±0.10	±0.10
060PD	-60	60	psi	145	145	245	245	250	±0.15	±0.075	11.52	12.00	12.48	±0.25	±0.50	±0.50	±1.25	±0.15	±0.10	±0.10

<sup>1</sup>**Overpressure:** The maximum pressure which may safely be applied to the product for it to remain within specifications once pressure is returned to the operating pressure range. Exposure to higher pressures may cause permanent damage to the product. Unless otherwise specified, this applies to all available pressure ports at any temperature within the operating temperature range.

<sup>2</sup>**Burst pressure:** The maximum pressure that may be applied to the specified port (P1 or P2) of the product without causing escape of pressure media. Product should not be expected to function after exposure to any pressure beyond the burst pressure.

<sup>3</sup>**Common mode pressure:** The maximum pressure that can be applied simultaneously to both ports of a differential pressure sensor without causing changes in specified performance.

<sup>4</sup>**Accuracy:** The maximum deviation in output from a Best Fit Straight Line (BFSL) fitted to the output measured over the pressure range at 25°C. Includes all errors due to pressure non-linearity, pressure hysteresis, and non-repeatability.

<sup>5</sup>**Offset:** The output signal obtained when the reference pressure is applied to all available pressure ports. Also known as “null” or “zero”.

<sup>6</sup>**Full Scale Span:** The algebraic difference between the output signal measured at the maximum and minimum limits of the pressure range (see Figure 1) for pressure ranges).

<sup>7</sup>**Thermal effect on offset:** The deviation in offset due to changes in temperature over the compensated temperature range, relative to offset measured at 25°C.

<sup>8</sup>**Thermal effect on span:** The deviation in full scale span due to changes in temperature over the compensated temperature range, relative to full scale span measured at 25°C.

<sup>9</sup>**Thermal hysteresis:** The maximum difference between output readings when the same temperature is reached consecutively, under the same operating conditions, with temperature approaching from opposite directions within the operating temperature range. Validated over the full operating temperature and pressure ranges using a ~5°C/ minute ramp and 30 minute dwell. Application performance may be affected by thermal mass of end user system.

# TBP SERIES AND NBP SERIES BASIC BOARD MOUNT PRESSURE SENSORS

**TABLE 9. NBP SERIES PRESSURE RANGE SPECIFICATIONS FOR 60 mBAR TO 10 BAR**

Pressure Range (see Figure 2)	Pressure Range		Unit	Over-Pressure <sup>1</sup>		Burst Pressure <sup>2</sup>		Common Mode Pressure <sup>3</sup>	Offset <sup>4</sup> (mV/V)		Sensitivity (mV/V/Full Scale Span)			Thermal Effect on Offset (%FSS/25°C) <sup>5</sup>			Thermal Effect on Span (%FSS/25°C) <sup>6</sup>		
	Pmin.	Pmax.		Port 1	Port 2	Port 1	Port 2		Min.	Max.	Min.	Nom.	Max.	Min.	Nom.	Max.	Min.	Nom.	Max.
<b>ABSOLUTE</b>																			
001BA	0	1	bar	2	–	4	–	–	-7.0	7.0	10.0	15.0	20.0	-1.5	-0.5	1.5	-6.0	-5.0	-3.5
1.6BA	0	1.6	bar	4	–	8	–	–	-7.0	7.0	12.0	16.0	20.0	-1.5	-0.5	1.5	-6.0	-5.0	-3.5
2.5BA	0	2.5	bar	4	–	8	–	–	-7.0	7.0	18.8	25.0	31.3	-1.0	-0.3	1.0	-6.0	-5.0	-3.5
004BA	0	4	bar	8	–	16	–	–	-7.0	7.0	16.8	20.0	23.2	-1.0	-0.3	1.0	-6.0	-5.0	-3.5
006BA	0	6	bar	16	–	20	–	–	-7.0	7.0	12.6	15.0	17.4	-1.5	-0.4	1.5	-6.0	-5.0	-3.5
010BA	0	10	bar	16	–	20	–	–	-7.0	7.0	21.0	25.0	29.0	-1.0	-0.3	1.0	-6.0	-5.0	-3.5
<b>GAGE</b>																			
060MG	0	60	mbar	850	–	1400	–	–	-8.5	8.5	3.9	5.7	7.4	-3.5	-1.2	3.5	-6.0	-5.0	-3.5
100MG	0	100	mbar	850	–	1400	–	–	-8.5	8.5	6.6	9.4	12.3	-2.1	-0.7	2.1	-6.0	-5.0	-3.5
160MG	0	160	mbar	850	–	1400	–	–	-8.5	8.5	10.5	15.1	19.7	-1.3	-0.4	1.3	-6.0	-5.0	-3.5
250MG	0	250	mbar	1800	–	3000	–	–	-8.5	8.5	7.3	10.9	14.5	-2.1	-0.7	2.1	-6.0	-5.0	-3.5
400MG	0	400	mbar	1800	–	3000	–	–	-8.5	8.5	11.7	17.4	23.2	-1.3	-0.4	1.3	-6.0	-5.0	-3.5
600MG	0	600	mbar	2000	–	4000	–	–	-7.0	7.0	6.0	9.0	12.0	-2.5	-1.0	2.5	-6.0	-5.0	-3.5
001BG	0	1	bar	2	–	4	–	–	-7.0	7.0	10.0	15.0	20.0	-1.5	-0.5	1.5	-6.0	-5.0	-3.5
1.6BG	0	1.6	bar	4	–	8	–	–	-7.0	7.0	12.0	16.0	20.0	-1.5	-0.5	1.5	-6.0	-5.0	-3.5
2.5BG	0	2.5	bar	4	–	8	–	–	-7.0	7.0	18.8	25.0	31.3	-1.0	-0.3	1.0	-6.0	-5.0	-3.5
004BG	0	4	bar	8	–	16	–	–	-7.0	7.0	16.8	20.0	23.2	-1.0	-0.3	1.0	-6.0	-5.0	-3.5
006BG	0	6	bar	16	–	20	–	–	-7.0	7.0	12.6	15.0	17.4	-1.5	-0.4	1.5	-6.0	-5.0	-3.5
010BG	0	10	bar	16	–	20	–	–	-7.0	7.0	21.0	25.0	29.0	-1.0	-0.3	1.0	-6.0	-5.0	-3.5
<b>DIFFERENTIAL</b>																			
060MD	-60	60	mbar	850	850	1400	1400	10000	-8.5	8.5	7.8	11.4	14.8	-1.8	-0.6	1.8	-6.0	-5.0	-3.5
100MD	-100	100	mbar	850	850	1400	1400	10000	-8.5	8.5	13.2	18.8	24.6	-1.1	-0.4	1.1	-6.0	-5.0	-3.5
160MD	-160	160	mbar	850	850	1400	1400	10000	-8.5	8.5	21.0	30.2	39.4	-0.7	-0.2	0.7	-6.0	-5.0	-3.5
250MD	-250	250	mbar	1800	1800	3000	3000	10000	-8.5	8.5	14.6	21.8	29.0	-1.1	-0.4	1.1	-6.0	-5.0	-3.5
400MD	-400	400	mbar	1800	1800	3000	3000	10000	-8.5	8.5	23.4	34.8	46.4	-0.7	-0.2	0.7	-6.0	-5.0	-3.5
600MD	-600	600	mbar	2000	2000	4000	4000	10000	-7.0	7.0	12.0	18.0	24.0	-1.3	-0.5	1.3	-6.0	-5.0	-3.5
001BD	-1	1	bar	2	2	4	4	10	-7.0	7.0	20.0	30.0	40.0	-0.8	-0.3	0.8	-6.0	-5.0	-3.5
1.6BD	-1.6	1.6	bar	4	4	8	8	10	-7.0	7.0	24.0	32.0	40.0	-0.8	-0.3	0.8	-6.0	-5.0	-3.5
2.5BD	-2.5	2.5	bar	4	4	8	8	10	-7.0	7.0	37.6	50.0	62.6	-0.5	-0.2	0.5	-6.0	-5.0	-3.5
004BD	-4	4	bar	8	8	16	16	15	-7.0	7.0	33.6	40.0	46.4	-0.5	-0.2	0.5	-6.0	-5.0	-3.5

<sup>1</sup>**Overpressure:** The maximum pressure which may safely be applied to the product for it to remain within specifications once pressure is returned to the operating pressure range. Exposure to higher pressures may cause permanent damage to the product. Unless otherwise specified, this applies to all available pressure ports at any temperature within the operating temperature range.

<sup>2</sup>**Burst pressure:** The maximum pressure that may be applied to the specified port (P1 or P2) of the product without causing escape of pressure media. Product should not be expected to function after exposure to any pressure beyond the burst pressure.

<sup>3</sup>**Common mode pressure:** The maximum pressure that can be applied simultaneously to both ports of a differential pressure sensor without causing changes in specified performance.

<sup>4</sup>**Offset:** The output signal obtained when the reference pressure is applied to all available pressure ports. Also known as “null” or “zero”.

<sup>5</sup>**TCO (Thermal Effect on Offset):** The deviation in offset due to changes in temperature over the specified temperature range, relative to offset measured at 25°C.

<sup>6</sup>**TCS (Thermal Effect on Span):** The deviation in full scale span due to changes in temperature over the specified temperature range, relative to full scale span measured at 25°C.

# TBP SERIES AND NBP SERIES BASIC BOARD MOUNT PRESSURE SENSORS

**TABLE 10. NBP SERIES PRESSURE RANGE SPECIFICATIONS FOR 1 PSI TO 150 PSI**

Pressure Range (see Figure 2)	Pressure Range		Unit	Over-Pressure <sup>1</sup>		Burst Pressure <sup>2</sup>		Common Mode Pressure <sup>3</sup>	Offset <sup>4</sup> (mV/V)		Sensitivity (mV/V/Full Scale Span)			Thermal Effect on Offset (%FSS/25°C) <sup>5</sup>			Thermal Effect on Span (%FSS/25°C) <sup>6</sup>		
	Pmin.	Pmax.		Port 1	Port 2	Port 1	Port 2		Min.	Max.	Min.	Nom.	Max.	Min.	Nom.	Max.	Min.	Nom.	Max.
<b>ABSOLUTE</b>																			
015PA	0	15	psi	30	–	60	–	–	-7.0	7.0	10.3	15.0	20.7	-1.5	-0.6	1.5	-6.0	-5.0	-3.5
030PA	0	30	psi	60	–	120	–	–	-7.0	7.0	15.5	21.0	26.0	-1.0	-0.4	1.0	-6.0	-5.0	-3.5
060PA	0	60	psi	120	–	240	–	–	-7.0	7.0	17.4	21.0	24.0	-1.0	-0.3	1.0	-6.0	-5.0	-3.5
100PA	0	100	psi	240	–	300	–	–	-7.0	7.0	14.5	17.2	20.0	-1.0	-0.4	1.0	-6.0	-5.0	-3.5
150PA	0	150	psi	240	–	300	–	–	-7.0	7.0	21.7	26.0	30.0	-1.0	-0.3	1.0	-6.0	-5.0	-3.5
<b>GAGE</b>																			
001PG	0	1	psi	10	–	20	–	–	-8.5	8.5	4.5	6.5	8.5	-3.0	-1.0	3.0	-6.0	-5.0	-3.5
005PG	0	5	psi	30	–	40	–	–	-8.5	8.5	10.0	15.0	20.0	-1.5	-0.5	1.5	-6.0	-5.0	-3.5
015PG	0	15	psi	30	–	60	–	–	-7.0	7.0	10.3	15.0	20.7	-1.5	-0.6	1.5	-6.0	-5.0	-3.5
030PG	0	30	psi	60	–	120	–	–	-7.0	7.0	15.5	21.0	26.0	-1.0	-0.4	1.0	-6.0	-5.0	-3.5
060PG	0	60	psi	120	–	240	–	–	-7.0	7.0	17.4	21.0	24.0	-1.0	-0.3	1.0	-6.0	-5.0	-3.5
100PG	0	100	psi	240	–	300	–	–	-7.0	7.0	14.5	17.2	20.0	-1.0	-0.4	1.0	-6.0	-5.0	-3.5
150PG	0	150	psi	240	–	300	–	–	-7.0	7.0	21.7	26.0	30.0	-1.0	-0.3	1.0	-6.0	-5.0	-3.5
<b>DIFFERENTIAL</b>																			
001PD	-1	1	psi	10	10	20	20	150	-8.5	8.5	9.0	13.0	17.0	-1.5	-0.5	1.5	-6.0	-5.0	-3.5
005PD	-5	5	psi	30	30	40	40	150	-8.5	8.5	20.0	30.0	40.0	-0.8	-0.3	0.8	-6.0	-5.0	-3.5
015PD	-15	15	psi	30	30	60	60	150	-7.0	7.0	20.6	30.0	41.4	-0.8	-0.3	0.8	-6.0	-5.0	-3.5
030PD	-30	30	psi	60	60	120	120	150	-7.0	7.0	31.0	42.0	52.0	-0.5	-0.2	0.5	-6.0	-5.0	-3.5
060PD	-60	60	psi	120	120	240	240	250	-7.0	7.0	34.8	42.0	48.0	-0.5	-0.2	0.5	-6.0	-5.0	-3.5

<sup>1</sup>**Overpressure:** The maximum pressure which may safely be applied to the product for it to remain within specifications once pressure is returned to the operating pressure range. Exposure to higher pressures may cause permanent damage to the product. Unless otherwise specified, this applies to all available pressure ports at any temperature within the operating temperature range.

<sup>2</sup>**Burst pressure:** The maximum pressure that may be applied to the specified port (P1 or P2) of the product without causing escape of pressure media. Product should not be expected to function after exposure to any pressure beyond the burst pressure.

<sup>3</sup>**Common mode pressure:** The maximum pressure that can be applied simultaneously to both ports of a differential pressure sensor without causing changes in specified performance.

<sup>4</sup>**Offset:** The output signal obtained when the reference pressure is applied to all available pressure ports. Also known as “null” or “zero”.

<sup>5</sup>**TCO (Thermal Effect on Offset):** The deviation in offset due to changes in temperature over the specified temperature range, relative to offset measured at 25°C.

<sup>6</sup>**TCS (Thermal Effect on Span):** The deviation in full scale span due to changes in temperature over the specified temperature range, relative to full scale span.

# TBP SERIES AND NBP SERIES BASIC BOARD MOUNT PRESSURE SENSORS

FIGURE 3. DIP PACKAGE DIMENSIONAL DRAWINGS (FOR REFERENCE ONLY: MM [IN].)

AN: Single axial small barbed port

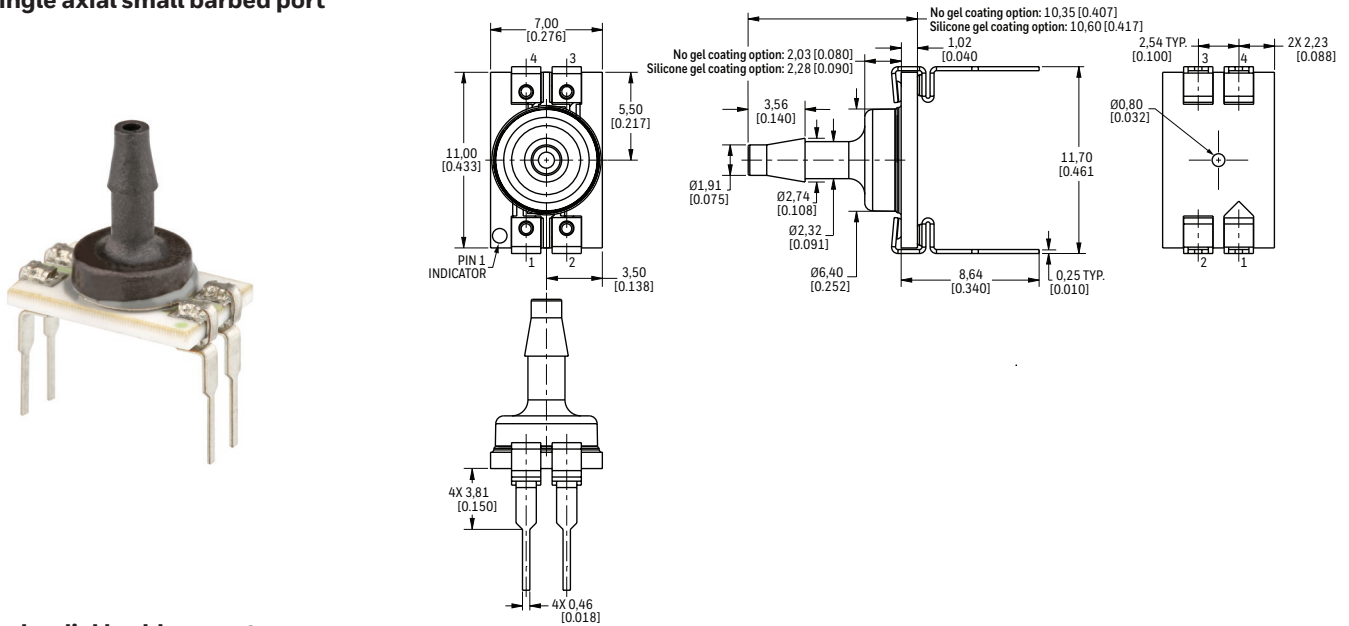

JJ: Dual radial barbless port

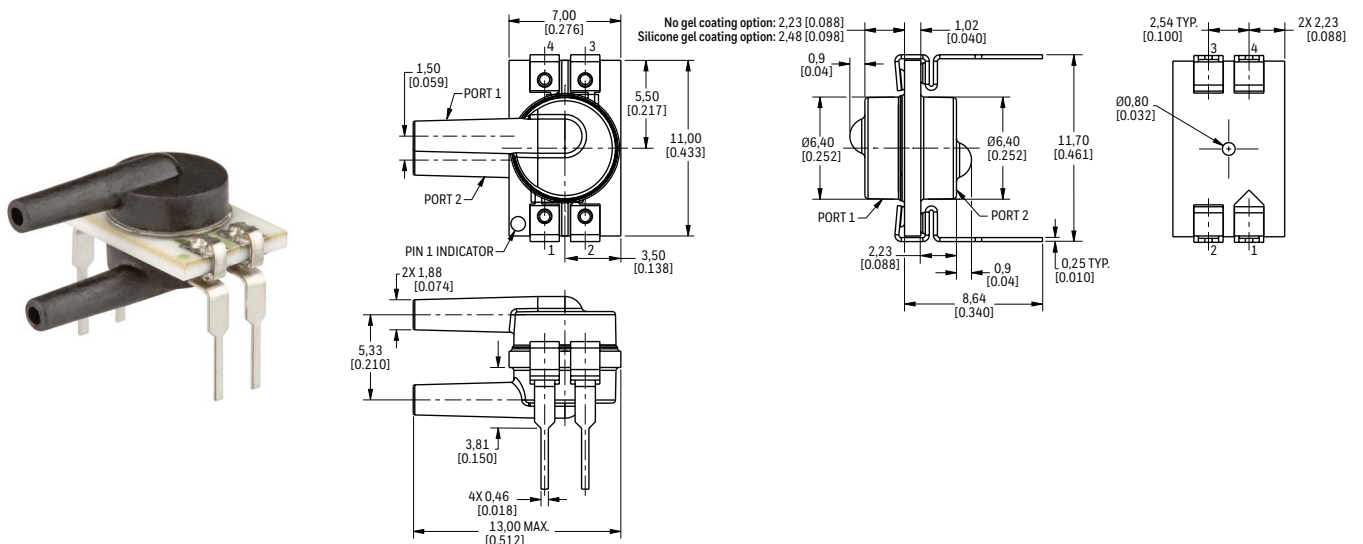

JN: Single radial barbless port

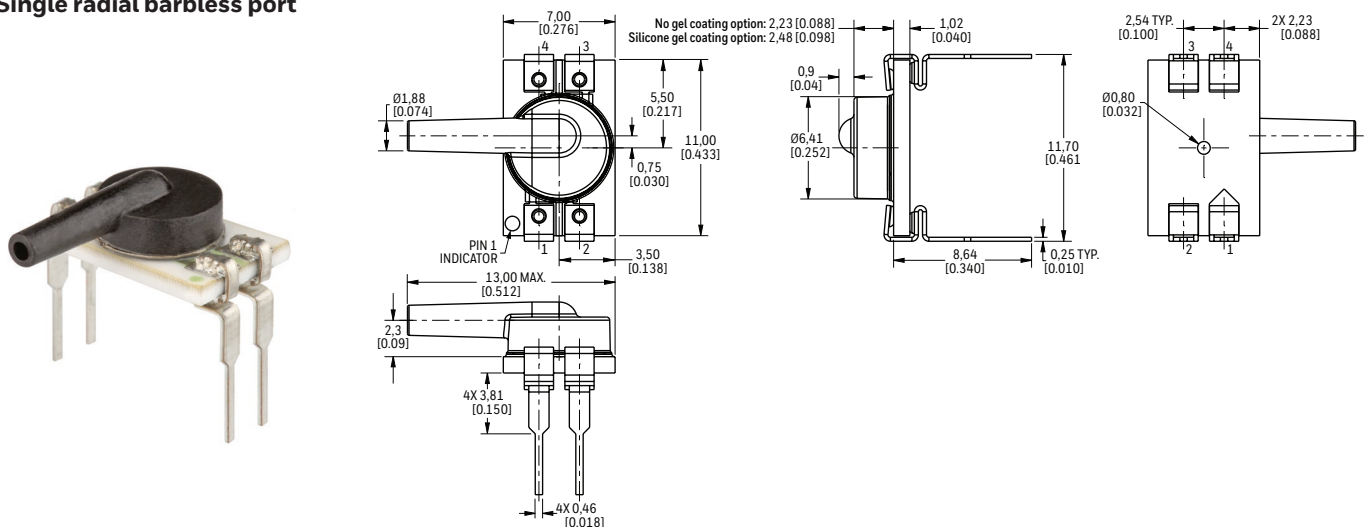

# TBP SERIES AND NBP SERIES BASIC BOARD MOUNT PRESSURE SENSORS

FIGURE 3. DIP PACKAGE DIMENSIONAL DRAWINGS (FOR REFERENCE ONLY: MM [IN], CONTINUED.)

**KN: Single axial large barbed port**

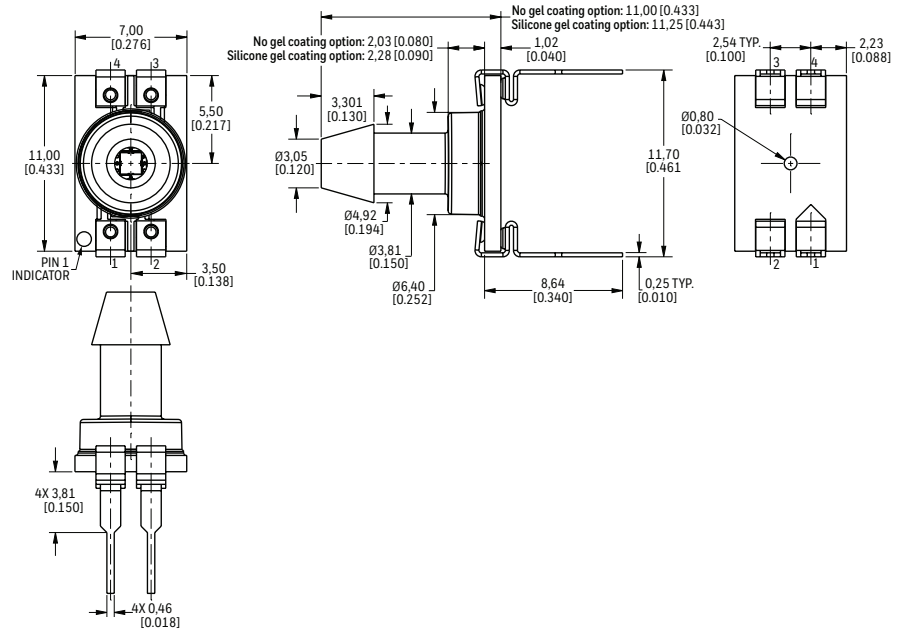
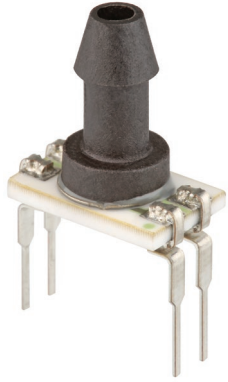

**LN: Single axial barbless port**

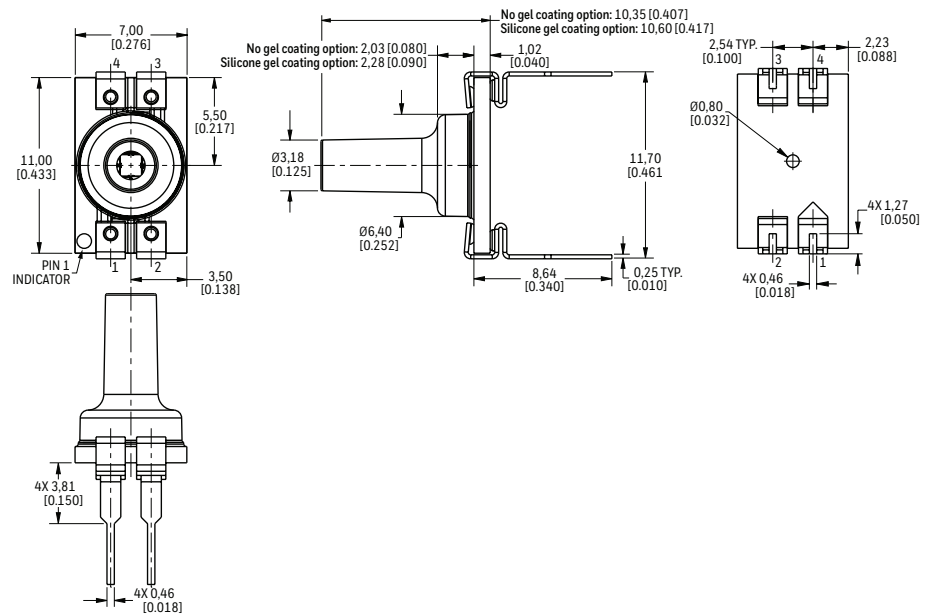
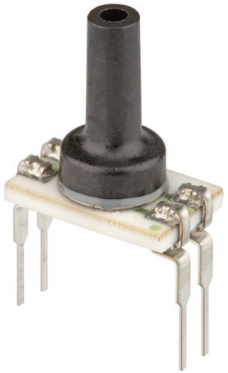

**PN: Low-profile port**

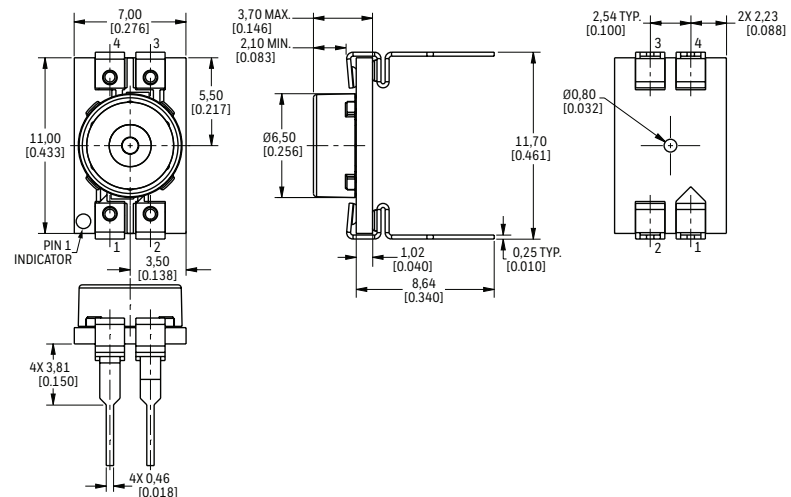
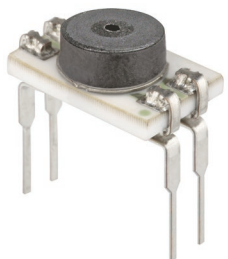

# TBP SERIES AND NBP SERIES BASIC BOARD MOUNT PRESSURE SENSORS

FIGURE 3. DIP PACKAGE DIMENSIONAL DRAWINGS (FOR REFERENCE ONLY: MM [IN], CONTINUED.)

**RN: Single radial barbed port**

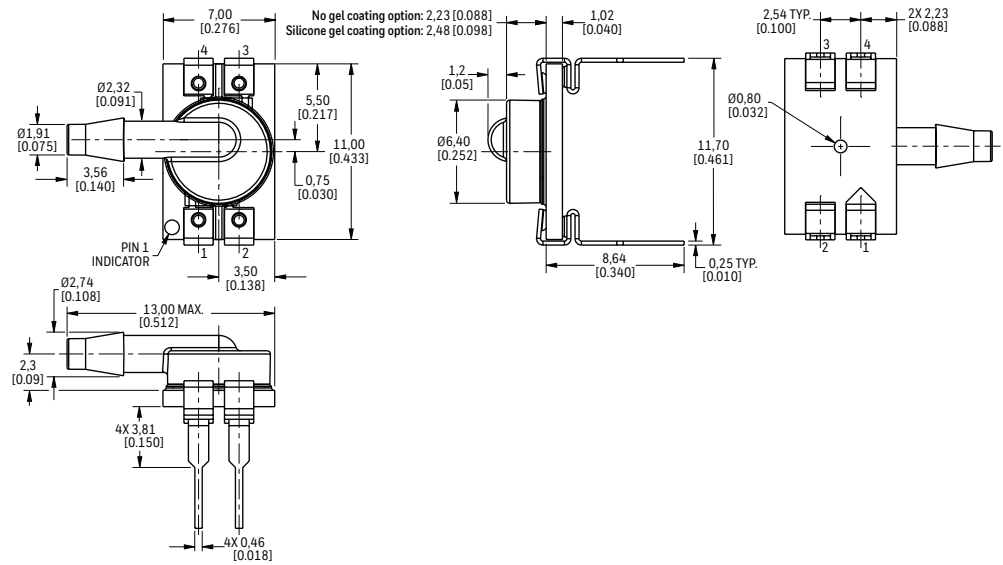
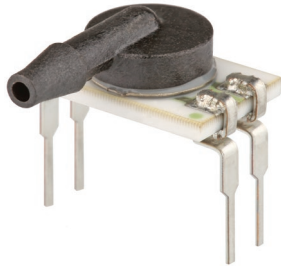

**RR: Dual radial barbed port**

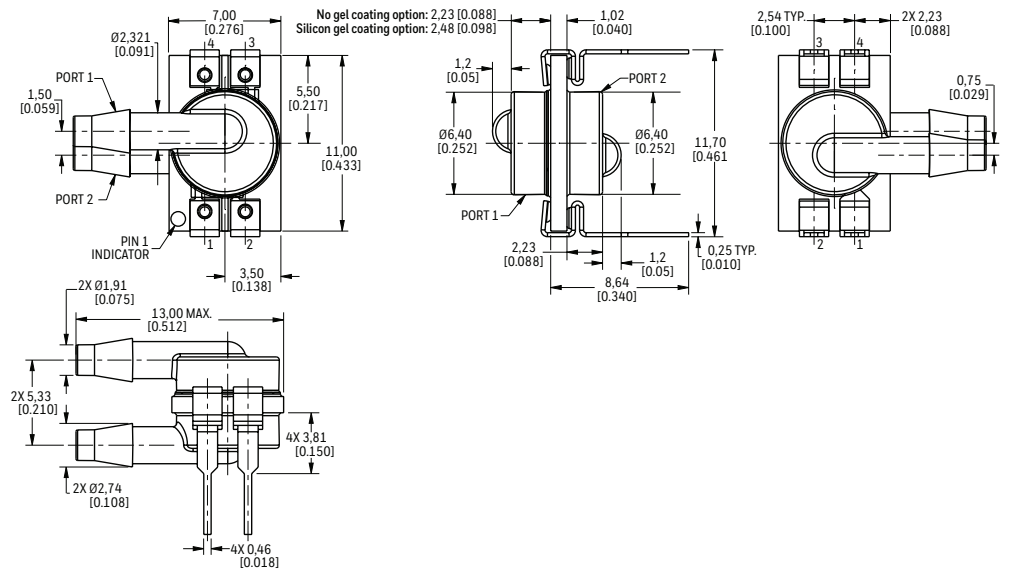
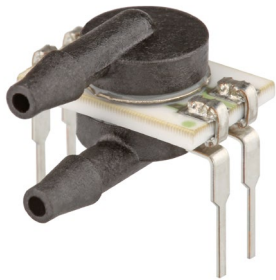

**VN: Single axial barbless straight port**

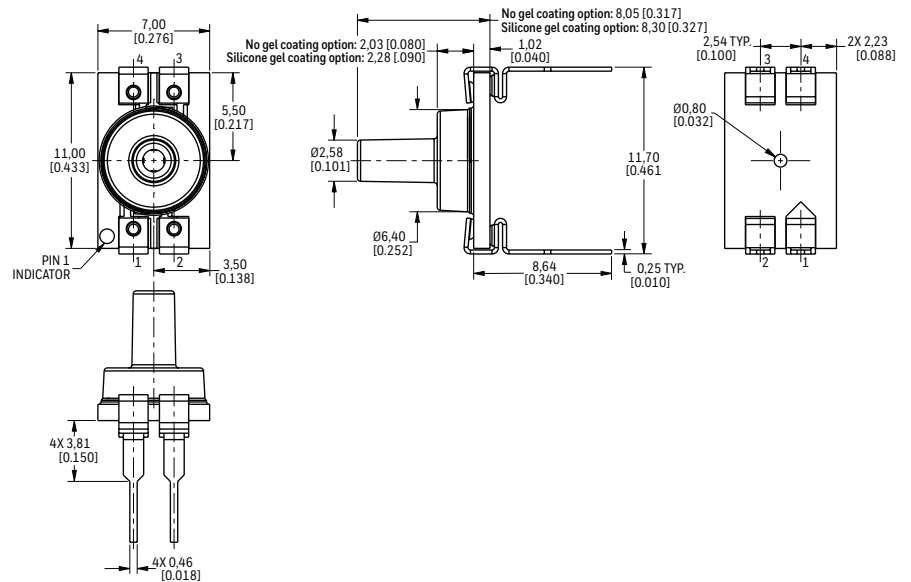
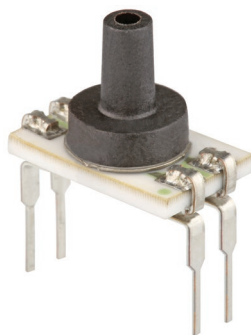

# TBP SERIES AND NBP SERIES BASIC BOARD MOUNT PRESSURE SENSORS

FIGURE 3. DIP PACKAGE DIMENSIONAL DRAWINGS (FOR REFERENCE ONLY: MM [IN], CONTINUED.)

## Recommended DIP Package PCB Pad Layout

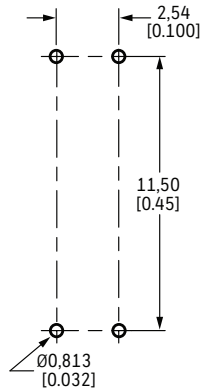

DIP PACKAGE PINOUT	
PIN	FUNCTION
1	Vsupply
2	Vout-
3	GND
4	Vout+

FIGURE 4. SMT PACKAGE DIMENSIONAL DRAWINGS (FOR REFERENCE ONLY: MM [IN].)

## AN: Single axial small barbed port

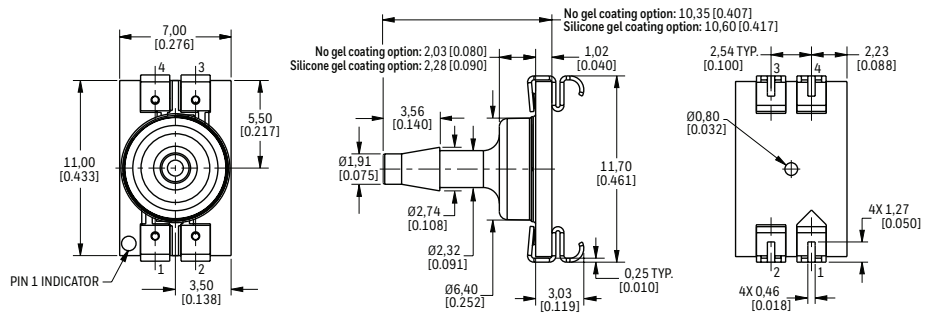

## JN: Single radial barbless port

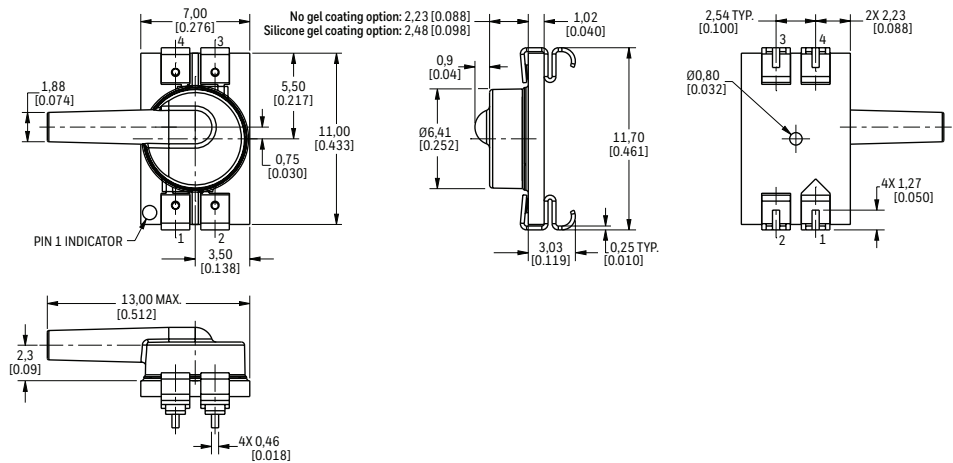



# TBP SERIES AND NBP SERIES BASIC BOARD MOUNT PRESSURE SENSORS

FIGURE 4. SMT PACKAGE DIMENSIONAL DRAWINGS (FOR REFERENCE ONLY: MM [IN], CONTINUED.)

VN: Single axial barbless straight port

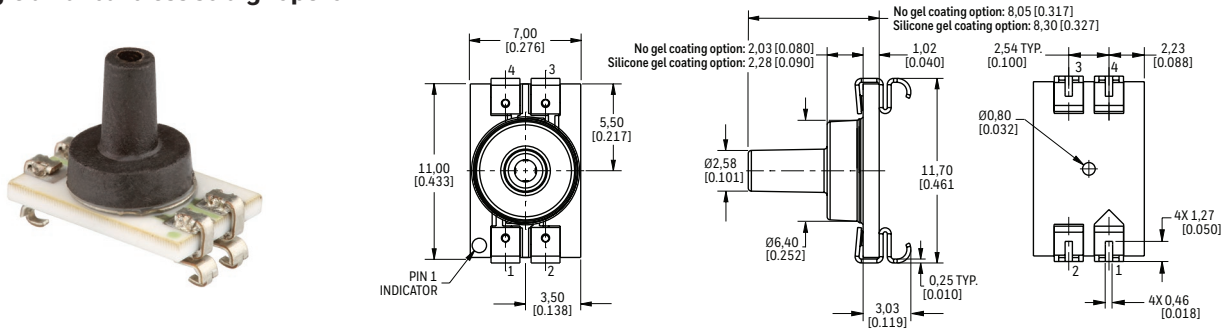

Recommended SMT Package PCB Pad Layout

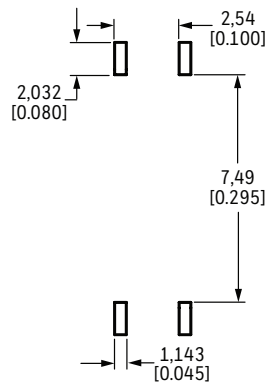

## SMT PACKAGE PINOUT

PIN	FUNCTION
1	Vsupply
2	Vout-
3	GND
4	Vout+

FIGURE 5. LEADLESS SMT PACKAGE DIMENSIONAL DRAWINGS (FOR REFERENCE ONLY: MM [IN].)

AN: Single axial small barbed port

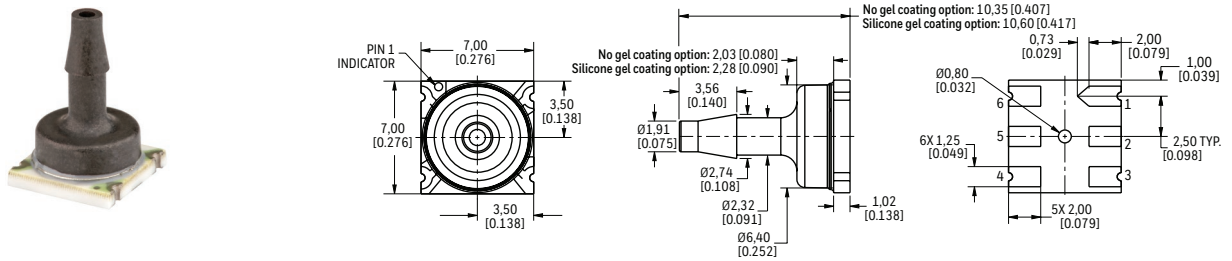

JN: Single radial barbless port

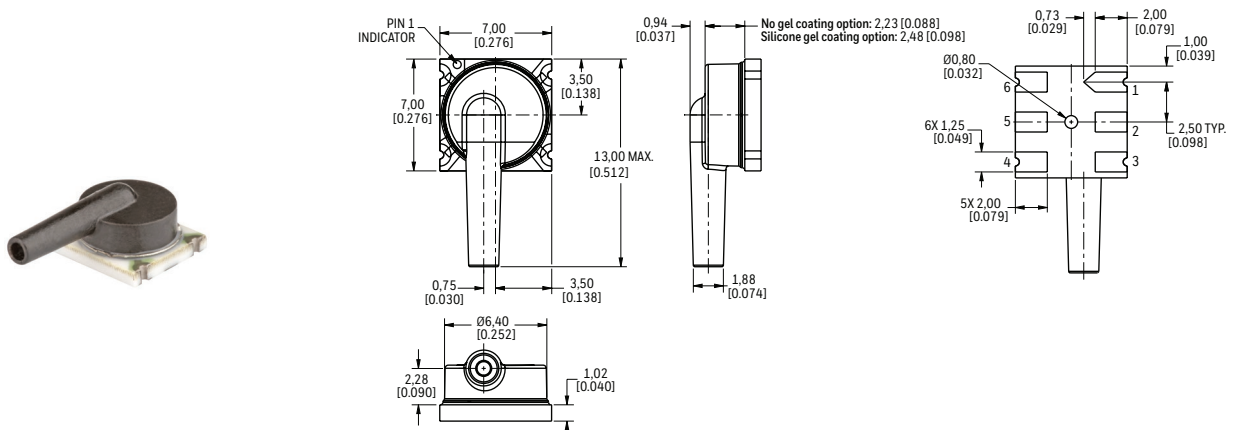

# TBP SERIES AND NBP SERIES BASIC BOARD MOUNT PRESSURE SENSORS

FIGURE 5. LEADLESS SMT PACKAGE DIMENSIONAL DRAWINGS (FOR REFERENCE ONLY: MM [IN], CONTINUED.)

**KN: Single axial large barbed port**

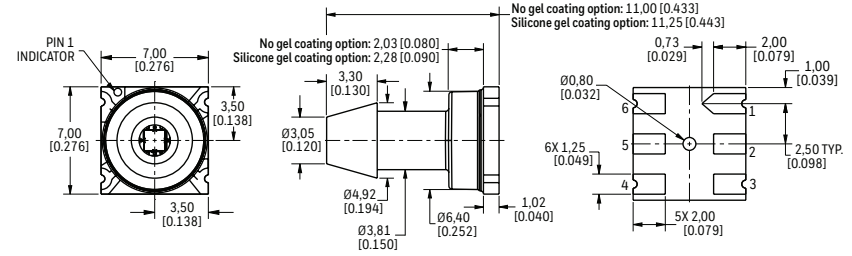

**LN: Single axial barbless port**

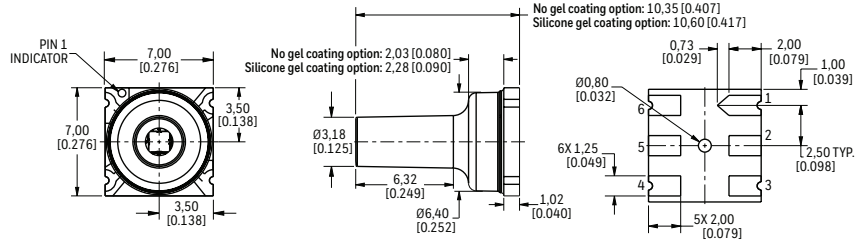

**PN: Low-profile port**

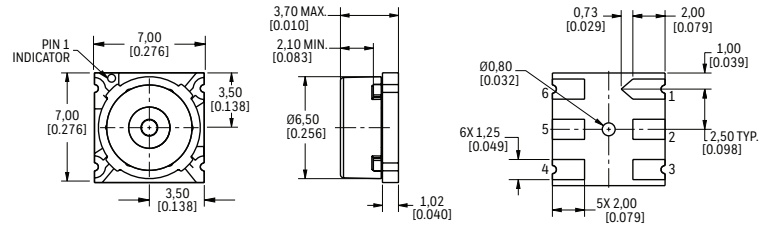

**RN: Single radial barbed port**

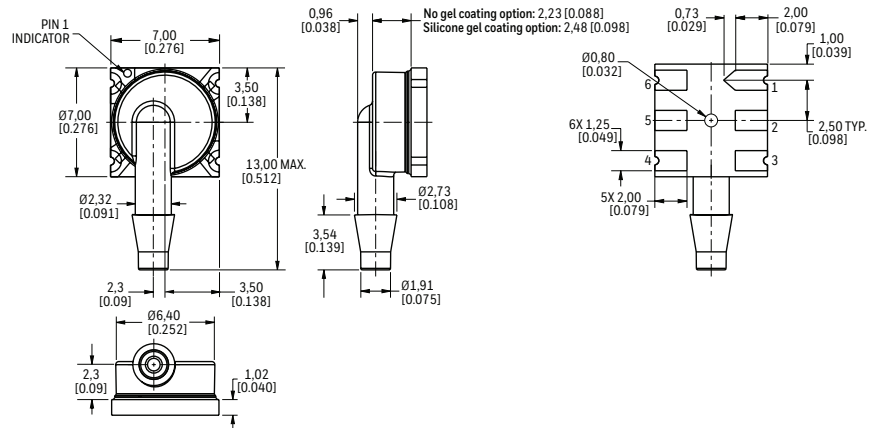

**VN: Single axial barbless straight port**

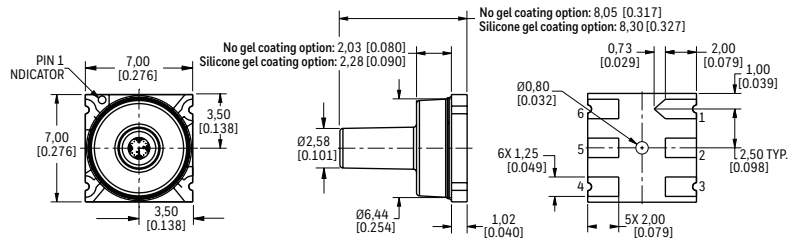

**Recommended Leadless SMT PCB Pad Layout**

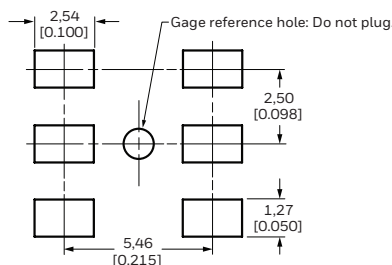

## LEADLESS SMT PINOUT

PIN	FUNCTION
1	Vsupply
2	NC
3	Vout-
4	GND
5	NC
6	Vout+

## TBP SERIES AND NBP SERIES BASIC BOARD MOUNT PRESSURE SENSORS

**TABLE 11. FOOD GRADE REGULATIONS**

NAME	DESCRIPTION
32309475-00A	South Korea Food Grade Regulation Certificate for SS304
32309475-00B	SS304 Food Grade Regulation Certificate - Europe, France, Italy, Germany (LFGB), Netherlands, Finland, Norway, Denmark, Switzerland, Sweden. Note: Australia follows EU or USA FDA food grade regulations.
32327768-00A	South Korea Food Grade Regulation Certificate for silpuran2130 gel
32327768-00B	SILPURAN 2130 Food Grade Regulation Certificate - Europe, France, Italy, Germany (LFGB), Netherlands, Finland, Norway, Denmark, Switzerland, Sweden. Note: Australia follows EU or USA FDA food grade regulations
32327768-00C	SILPURAN 2130 A & B Gel FDA letter
32332678-00A	South Korea Food Grade Regulation Certificate for High temp Nylon based plastic
32332678-00B	Plastic Part Food Grade Regulation Certificate- Europe, France, Italy, Germany(LFGB), Netherlands, Finland, Norway, Denmark, Switzerland, Sweden. Note: Australia follows EU or USA FDA food grade regulations
32332678-00C	Nylon resin Zytal HTNFG52G35HSLR BK011 FDA letter
32339019-00A	South Korea Food Grade Regulation Certificate for GL107 adhesive
32339019-00B	GL107 adhesive BPA Free test certificate as per French decree
32339019-00C	GL107 adhesive Food Grade Regulation Certificate - Europe, France, Italy, Germany(LFGB), Netherlands, Finland, Norway, Denmark, Switzerland, Sweden. Note: Australia follows EU or USA FDA food grade regulations.
32339019-00D	GL 107 penchem Adhesive FDA letter
32340305-00A	EB350 adhesive BPA Free test certificate as per French decree
32347956	EU General Food Grade Regulation certificate for NBP, TBP, ABP, ABP2, MPR, ISC series
32347957	Food Grade Regulation Certificate from Europe, France, Italy, Germany(LFGB), Netherlands, Finland, Norway, Denmark, Switzerland, Sweden for NBP, TBP, ABP, ABP2, MPR, ISC series. Note: Australia follows EU or USA FDA food grade regulations.
32347958	Singapore Food Grade Regulation Certificate for NBP, TBP, ABP, ABP2, MPR, ISC series
32347959	NBP/TBP product BPA free test certificate as per French decree
32347960	NSF-169-C0280766 for NBP, TBP, ABP, ABP2, MPR, ISC series
32347961-00A	China Food Grade Regulation Certificate for TFN, SS304 gel ring and plastic part
32347961-00B	China Food Grade Regulation Certificate for GL107 adhesive, RTV6424 adhesive and SILPURAN 2130 gel part
32347962-00A	Japan Food Grade Regulation Certificate for TFN, SS304 gel ring and high temp nylon based plastic part
32347962-00B	Japan Food Grade Regulation Certificate for GL107adhesive, RTV6424 adhesive and SILPURAN 2130 gel part
50039078-00A	South Korea Food Grade Regulation Certificate for RTV6424 adhesive
50039078-00B	RTV6424 adhesive Food Grade Regulation Certificate - Europe, France, Italy, Germany (LFGB), Netherlands, Finland, Norway, Denmark, Switzerland, Sweden. Note: Australia follows EU or USA FDA food grade regulations.
50039078-00C	RTV6424 Adhesive FDA letter
50071551-00A	South Korea Food Grade Regulation Certificate for ceramic alumina (TFN)
50071551-00B	TFN Food Grade Regulation Certificate - Europe, France, Italy, Germany (LFGB), Netherlands, Finland, Norway, Denmark, Switzerland, Sweden. Note: Australia follows EU or USA FDA food grade regulations.
32339019-00E	GL107 adhesive pthalates_Reach and RoHS compliance certificate
32327768-00D	SILPURAN 2130 adhesive pthalates_Reach and RoHS compliance certificate

## ADDITIONAL MATERIALS

The following associated literature is available at our [website](#):

- Product range guide
- Product installation instructions
- Application-specific information
- CAD Models

## FOR MORE INFORMATION

Honeywell Advanced Sensing Solutions services its customers through a worldwide network of sales offices and distributors. For application assistance, current specifications, pricing or the nearest Authorized Distributor, visit our [website](#) or call:

USA/Canada	+1 302 613 4491
Latin America	+1 305 805 8188
Europe	+44 1344 238258
Japan	+81 (0) 3-6730-7152
Singapore	+65 6355 2828
Greater China	+86 4006396841

## Honeywell Advanced Sensing Technologies

830 East Arapaho Road  
Richardson, TX 75081  
[sps.honeywell.com/ast](http://sps.honeywell.com/ast)

## WARRANTY/REMEDY

Honeywell warrants goods of its manufacture as being free of defective materials and faulty workmanship during the applicable warranty period. Honeywell's standard product warranty applies unless agreed to otherwise by Honeywell in writing; please refer to your order acknowledgment or consult your local sales office for specific warranty details. If warranted goods are returned to Honeywell during the period of coverage, Honeywell will repair or replace, at its option, without charge those items that Honeywell, in its sole discretion, finds defective.

**The foregoing is buyer's sole remedy and is in lieu of all other warranties, expressed or implied, including those of merchantability and fitness for a particular purpose. In no event shall Honeywell be liable for consequential, special, or indirect damages.**

While Honeywell may provide application assistance personally, through our literature and the Honeywell web site, it is buyer's sole responsibility to determine the suitability of the product in the application.

Specifications may change without notice. The information we supply is believed to be accurate and reliable as of this writing. However, Honeywell assumes no responsibility for its use.

## WARNING PERSONAL INJURY

DO NOT USE these products as safety or emergency stop devices or in any other application where failure of the product could result in personal injury.

**Failure to comply with these instructions could result in death or serious injury.**

## WARNING MISUSE OF DOCUMENTATION

- The information presented in this product sheet is for reference only. Do not use this document as a product installation guide.
- Complete installation, operation, and maintenance information is provided in the instructions supplied with each product.

**Failure to comply with these instructions could result in death or serious injury.**

## Looking for pricing, stock, or lifecycle information?

Click below to explore more details on WIN SOURCE:

 [View NBPDANN100PAUNV on WIN SOURCE](#)

 [Honeywell Information](#)

## Optimize Your Supply Chain with WIN SOURCE Solutions

-  Global Sourcing Solution
-  Obsolete Management
-  Cost Control Management
-  Shortage Management
-  Alternative Solution
-  Excess Inventory Management