



**THE DATASHEET OF
AP1702DWG-7**



Features

- Precision Monitoring of +2.5V, +3V, +3.3V, and +5V Power-Supply Voltages
- Fully Specified Over Temperature
- Available in three Output Configurations
- Push-Pull **RESET** Low Output (AP1701/3)
- Push-Pull **RESET** High Output (AP1702/4)
- 200ms Min. Power-On Reset Pulse Width
- 20µA Supply Current (Typ.)
- Guaranteed Reset Valid to $V_{CC} = +1V$
- Power Supply Transient Immunity
- No External Components
- Green Packages: SC59-3L and SOT23
- Lead Free Finish / RoHS Compliant (Note 1)

General Description

The AP1701/2/3/4 are used for microprocessor (μP) supervisory circuits to monitor the power supplies in μP and digital systems. They provide excellent circuit reliability and low cost by eliminating external components and adjustments when used with +5V, +3.3V, +3.0V powered circuits.

These circuits perform a single function: they assert a reset signal whenever the V_{CC} supply voltage declines below a preset threshold, keeping it asserted for at least 240ms after V_{CC} has risen above the reset threshold. Reset thresholds suitable for operation with a variety of supply voltages are available. The AP1701/2/3/4 have push pull outputs. The AP1701/3 have an active low **RESET** output, while the AP1702/4 has an active high **RESET** output. The reset comparator is designed to ignore fast transients on V_{CC} , and the outputs are guaranteed to be in the correct logic state for V_{CC} down to 1V. Low supply current makes the AP1701/2/3/4 ideal for use in portable equipment. The AP1701/2/3/4 is available in a 3-pin SC59 package.

Applications

- Computers
- Controllers
- Intelligent Instruments
- Critical μP and μC Power Monitoring
- Portable/Battery Powered Equipment
- Automotive

Ordering Information

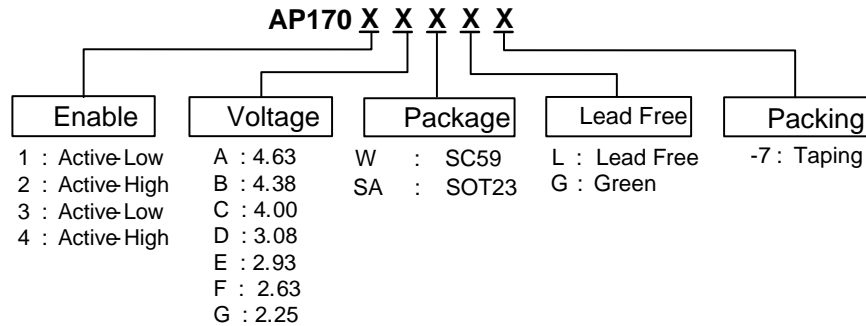

Notes: 1. RoHS revision 13.2.2003. Glass and High Temperature Solder Exemptions Applied, see *EU Directive Annex Notes 5 and 7*.

Device	Package Code	Packaging (Note 2)	7" Tape and Reel	
			Quantity	Part Number Suffix
AP170XXW	W	SC59	3000/Tape & Reel	-7
AP170XXSA	SA	SOT23	3000/Tape & Reel	-7

Notes: 2. Pad layout as shown on Diodes Inc. suggested pad layout document AP02001, which can be found on our website at <http://www.diodes.com/datasheets/ap02001.pdf>.

Pin Assignments



Pin Descriptions

Name	Description
GND	Ground
$\overline{\text{RESET}}$ (RESET)	Reset Output Pin L: for AP1701/3 H: for AP1702/4
V_{CC}	Operating Voltage Input

Absolute Maximum Ratings

Symbol	Parameter	Rating	Unit
V_{CC}	Terminal Voltage (with respect to GND)	-0.3 to +6.0	V
V_{RESET}	RESET, \overline{RESET} (push-pull)	-0.3 to ($V_{CC} + 0.3$)	V
I_{CC}	Input Current, V_{CC}	20	mA
I_O	Output Current, RESET, \overline{RESET}	20	mA
P_D	Continuous Power Dissipation ($T_A = +70^\circ\text{C}$), de-rate 4mW/°C above +70°C	320	mW
T_{OP}	Operating Junction Temperature Range	-40 to +105	°C
T_{ST}	Storage Temperature Range	-65 to +150	°C

Electrical Characteristics ($T_A = 25^\circ\text{C}$)

Symbol	Parameter	Conditions	Min.	Typ.	Max.	Unit
V_{CC}	V_{CC} Range	$T_A = 0^\circ\text{C}$ to $+70^\circ\text{C}$	1.0		5.5	V
I_{CC}	Supply Current	$V_{TH} + 1.0\text{V}$		20	30	μA
V_{TH}	Reset Threshold $T_A = 25^\circ\text{C}$	AP1701/2/3/4A	4.54	4.63	4.72	V
		AP1701/2/3/4B	4.29	4.38	4.47	
		AP1701/2/3/4C	3.92	4.00	4.08	
		AP1701/2/3/4D	3.02	3.08	3.14	
		AP1701/2/3/4E	2.87	2.93	2.99	
		AP1701/2/3/4F	2.57	2.63	2.68	
		AP1701/2/3/4G	2.20	2.25	2.30	
	Reset Threshold Tempco			30		ppm/ °C
T_S	Set-up Time	$V_{CC} = 0$ to ($V_{TH} - 100\text{mV}$)	100			μs
T_{DELAY}	Reset Active Timeout Period	$T_A = 0^\circ\text{C}$ to $+70^\circ\text{C}$	100	240	600	ms
V_{OL}	\overline{RESET} Output Voltage Low	$V_{CC} = V_{TH}$ min, $I_{SINK} = 1.2\text{mA}$, AP1701/3			0.3	V
		$V_{CC} = V_{TH}$ min, $I_{SINK} = 3.2\text{mA}$			0.4	
		$V_{CC} > 1.0\text{V}$, $I_{SINK} = 50\mu\text{A}$			0.3	
V_{OH}	\overline{RESET} Output Voltage-High	$V_{CC} > V_{TH}$ max, $I_{SOURCE} = 500\mu\text{A}$, AP1701/3	$0.8V_{CC}$			V
		$V_{CC} > V_{TH}$ max, $I_{SOURCE} = 800\mu\text{A}$	$V_{CC} - 1.5$			
V_{OL}	RESET Output Voltage-Low	$V_{CC} = V_{TH}$ max, $I_{SINK} = 1.2\text{mA}$, AP1702/4			0.3	V
		$V_{CC} = V_{TH}$ max, $I_{SINK} = 3.2\text{mA}$			0.4	
V_{OH}	RESET Output Voltage-High	$1.8\text{V} < V_{CC} < V_{TH}$ min, $I_{SOURCE} = 150\mu\text{A}$, AP1702/4	$0.8 V_{CC}$			V

Typical Application Circuit



Function Description

A microprocessor's (μ P's) reset input starts the μ P in a known state. The AP1701/2/3/4 assert reset to prevent code-execution errors during power-up, power-down, or brownout conditions. They assert a reset signal whenever the V_{CC} supply voltage declines below a preset threshold, keeping it asserted for at least 240ms after V_{CC} has risen above the reset threshold. The AP1701/2/3/4 have a push-pull output stage.

Applications Information

Negative-Going V_{CC} Transients

In addition to issuing a reset to the μ P during power-up, power-down, and brownout conditions, the AP1701/2/3/4 are relatively immune to short-duration negative-going V_{CC} transients (glitches).

The AP1701/2/3/4 do not generate a reset pulse. The graph was generated using a negative going pulse applied to V_{CC} , starting 0.5V above the actual reset threshold and ending below it by the magnitude indicated (reset comparator overdrive). The graph indicates the maximum pulse width a negative going V_{CC} transient can have without causing a reset pulse. As the magnitude of the transient increases (goes farther below the reset threshold), the maximum allowable pulse width decreases. Typically, a V_{CC} transient that goes 100mV below the reset threshold and lasts 100 μ s or less will not cause a reset pulse. A 0.1 μ F bypass capacitor mounted as close as possible to the V_{CC} pin provides additional transient immunity.

Ensuring a Valid Reset Output Down to $V_{CC} = 0$

$\overline{\text{RESET}}$ is guaranteed to be a logic low for $V_{CC} > 1V$. Once V_{CC} exceeds the reset threshold, an internal timer keeps $\overline{\text{RESET}}$ low for the reset timeout period; after this interval, $\overline{\text{RESET}}$ goes high. If a brownout condition occurs (V_{CC} dips $\overline{\text{RESET}}$

below the reset threshold), $\overline{\text{RESET}}$ goes low. Any time V_{CC} goes below the reset threshold, the internal timer resets to zero, and $\overline{\text{RESET}}$ goes low. The internal timer starts after V_{CC} returns above the reset threshold, and $\overline{\text{RESET}}$ remains low for the reset timeout period.

When V_{CC} falls below 1V, the AP1701/3 $\overline{\text{RESET}}$ output no longer sinks current—it becomes an open circuit. Therefore, high-impedance CMOS logic inputs connected to $\overline{\text{RESET}}$ can drift to undetermined voltages. This presents no problem in most applications since most μ P and other circuitry is inoperative with V_{CC} below 1V. However, in applications where $\overline{\text{RESET}}$ must be valid down to 0V, adding a pull down resistor to $\overline{\text{RESET}}$ causes any stray leakage currents to flow to ground, holding $\overline{\text{RESET}}$ low. R1's value is not critical; 100k are large enough not to load $\overline{\text{RESET}}$ and small enough to pull $\overline{\text{RESET}}$ to ground. For the AP1702/4 if $\overline{\text{RESET}}$ is required to remain valid for $V_{CC} < 1V$.

Benefits of Highly Accurate Reset Threshold

Most μ P supervisor ICs has reset threshold voltages between 5% and 10% below the value of nominal supply voltages. This ensures a reset will not occur within 5% of the nominal supply, but will occur when the supply is 10% below nominal. When using ICs rated at only the nominal supply $\pm 5\%$, this leaves a zone of uncertainty where the supply is between 5% and 10% low, and where the reset may or may not be asserted.

Block Diagram



Performance Characteristics



Timing Diagram

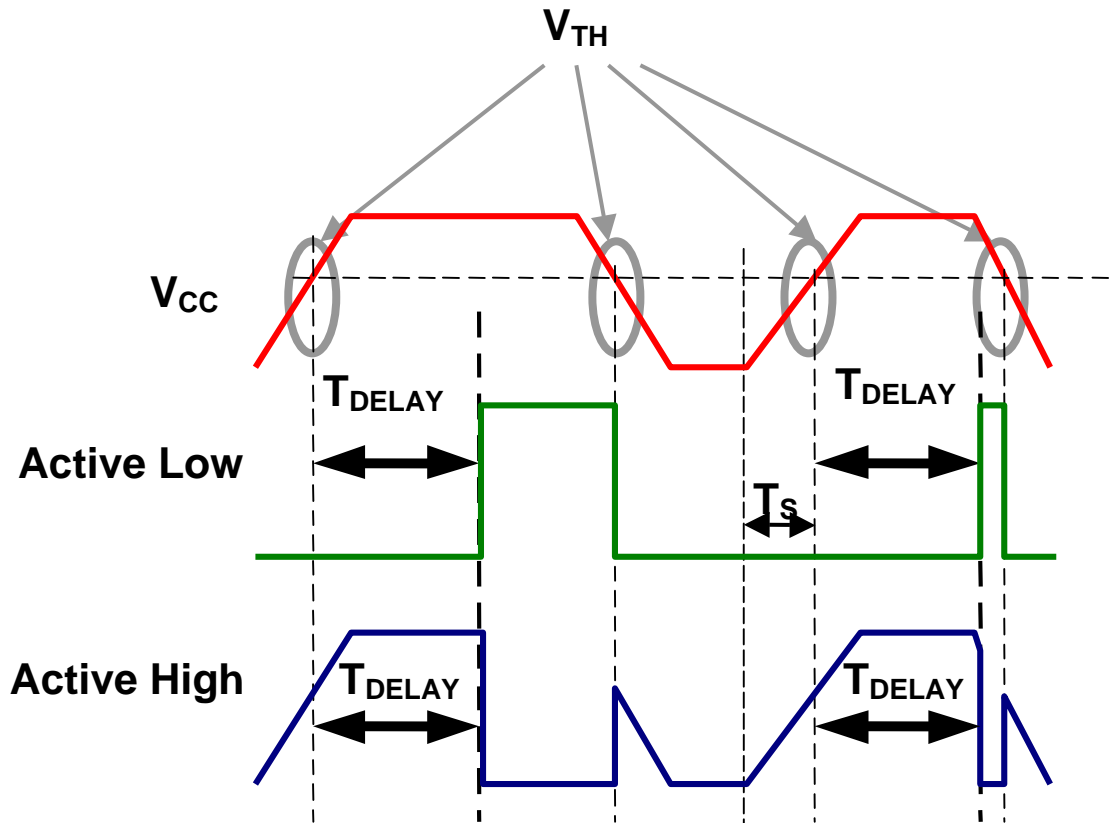

Marking Information

(1) SC59-3L



(2) SOT23





3-PIN MICROPROCESSOR RESET CIRCUITS

Marking Information (Continued)

Device	Package (Note 3)	Identification Code
AP1701ASA	SOT23	
AP1701BSA	SOT23	
AP1701CSA	SOT23	
AP1701DSA	SOT23	
AP1701ESA	SOT23	
AP1701FSA	SOT23	
AP1701GSA	SOT23	
AP1702ASA	SOT23	
AP1702BSA	SOT23	
AP1702CSA	SOT23	
AP1702DSA	SOT23	
AP1702ESA	SOT23	
AP1702FSA	SOT23	
AP1702GSA	SOT23	
AP1703ASA	SOT23	
AP1703BSA	SOT23	
AP1703CSA	SOT23	
AP1703DSA	SOT23	
AP1703ESA	SOT23	
AP1703FSA	SOT23	
AP1703GSA	SOT23	
AP1704ASA	SOT23	
AP1704BSA	SOT23	
AP1704CSA	SOT23	
AP1704DSA	SOT23	
AP1704ESA	SOT23	
AP1704FSA	SOT23	
AP1704GSA	SOT23	
AP1701AW	SC59	EA
AP1701BW	SC59	EB
AP1701CW	SC59	EC
AP1701DW	SC59	ED
AP1701EW	SC59	EE
AP1701FW	SC59	EF
AP1701GW	SC59	W1
AP1702AW	SC59	E0
AP1702BW	SC59	E2
AP1702CW	SC59	E3
AP1702DW	SC59	E4
AP1702EW	SC59	E5
AP1702FW	SC59	E6
AP1702GW	SC59	W2
AP1703AW	SC59	EG
AP1703BW	SC59	EH
AP1703CW	SC59	EI
AP1703DW	SC59	EJ
AP1703EW	SC59	EK
AP1703FW	SC59	EL
AP1703GW	SC59	W3
AP1704AW	SC59	E7
AP1704BW	SC59	E8
AP1704CW	SC59	E9
AP1704DW	SC59	EM
AP1704EW	SC59	EN
AP1704FW	SC59	EP
AP1704GW	SC59	W4

Notes: 3. For Packaging Details, go to our website at <http://www.diodes.com/datasheets/ap02007.pdf>.

Package Information (All Dimensions in mm)

(1) Package Type: SC59-3L



(2) Package Type: SOT23



IMPORTANT NOTICE



Diodes Incorporated and its subsidiaries reserve the right to make modifications, enhancements, improvements, corrections or other changes without further notice to any product herein. Diodes Incorporated does not assume any liability arising out of the application or use of any product described herein; neither does it convey any license under its patent rights, nor the rights of others. The user of products in such applications shall assume all risks of such use and will agree to hold Diodes Incorporated and all the companies whose products are represented on our website, harmless against all damages.

LIFE SUPPORT





Diodes Incorporated products are not authorized for use as critical components in life support devices or systems without the expressed written approval of the President of Diodes Incorporated.

Looking for pricing, stock, or lifecycle information?

Click below to explore more details on WIN SOURCE:

-  [View AP1702DWG-7 on WIN SOURCE](#)
-  [Diodes Incorporated](#) Information

Optimize Your Supply Chain with WIN SOURCE Solutions

-  Global Sourcing Solution
-  Obsolete Management
-  Cost Control Management
-  Shortage Management
-  Alternative Solution
-  Excess Inventory Management