



ELECTRONICS, INC.
 44 FARRAND STREET
 BLOOMFIELD, NJ 07003
 (973) 748-5089
<http://www.nteinc.com>

1N4728A thru 1N4764A Zener Diode, 1 Watt ±5% Tolerance

Features:

- Zener Voltage 3.3V to 100V

Absolute Maximum Ratings: ($T_A = +25^\circ\text{C}$, unless otherwise specified)

Power Dissipation ($T_L \leq +50^\circ\text{C}$, Lead Length = 3/8"), P_D 1.0W
 Derate Above +50 6.67mW/ $^\circ\text{C}$
 Operating Temperature Range, T_{opr} -65° to $+200^\circ\text{C}$
 Storage Temperature Range, T_{stg} -65° to $+200^\circ\text{C}$

Electrical Characteristics: ($T_A = +25^\circ\text{C}$, unless otherwise specified)

Device Number	Nominal Zener Voltage $V_z @ I_{zt}$	Zener Test Current (I_{zt})	Maximum Dynamic Impedance			Maximum Leakage Current $I_R @ V_R$	
			$Z_{zt} @ I_{zt}$	$Z_{zk} @ I_{zk}$		μA	Volts
	Volts	mA	Ω	Ω	mA	μA	Volts
1N4728A	3.3	76.0	10	400	1.0	100	1.0
1N4729A	3.6	69.0	10	400	1.0	100	1.0
1N4730A	3.9	64.0	9	400	1.0	50	1.0
1N4731A	4.3	58.0	9	400	1.0	10	1.0
1N4732A	4.7	53.0	8	500	1.0	10	1.0
1N4733A	5.1	49.0	7	550	1.0	10	1.0
1N4734A	5.6	45.0	5	600	1.0	10	2.0
1N4735A	6.2	41.0	2	700	1.0	10	3.0
1N4736A	6.8	37.0	3.5	700	1.0	10	4.0
1N4737A	7.5	34.0	4.0	700	0.5	10	5.0
1N4738A	8.2	31.0	4.5	700	0.5	10	6.0
1N4739A	9.1	28.0	5.0	700	0.5	10	7.0
1N4740A	10.0	25.0	7.0	700	0.25	10	7.6
1N4741A	11.0	23.0	8.0	700	0.25	5	8.4
1N4742A	12.0	21.0	9.0	700	0.25	5	9.1

Electrical Characteristics (Cont'd): ($T_A = +25^\circ\text{C}$, unless otherwise specified)

Device Number	Nominal Zener Voltage $V_z @ I_{zt}$	Zener Test Current (I_{zt})	Maximum Dynamic Impedance			Maximum Leakage Current $I_R @ V_R$	
			$Z_{zt} @ I_{zt}$	$Z_{zk} @ I_{zk}$		μA	Volts
	Volts	mA	Ω	Ω	mA	μA	Volts
1N4743A	13	19.0	10	700	0.25	5	9.9
1N4744A	15	17.0	14	700	0.25	5	11.4
1N4745A	16	15.5	16	700	0.25	5	12.2
1N4746A	18	14.0	20	750	0.25	5	13.7
1N4747A	20	12.5	22	750	0.25	5	15.2
1N4748A	22	11.5	23	750	0.25	5	16.7
1N4749A	24	10.5	25	750	0.25	5	18.2
1N4750A	27	9.5	35	750	0.25	5	20.6
1N4751A	30	8.5	40	1000	0.25	5	22.8
1N4752A	33	7.5	45	1000	0.25	5	25.1
1N4753A	36	7.0	50	1000	0.25	5	27.4
1N4754A	39	6.5	60	1000	0.25	5	29.7
1N4755A	43	6.0	70	1500	0.25	5	32.7
1N4756A	47	5.5	80	1500	0.25	5	35.8
1N4757A	51	5.0	95	1500	0.25	5	38.8
1N4758A	56	4.5	110	2000	0.25	5	42.6
1N4759A	62	4.0	125	2000	0.25	5	47.1
1N4760A	68	3.7	150	2000	0.25	5	51.7
1N4761A	75	3.3	175	2000	0.25	5	56.0
1N4762A	82	3.0	200	3000	0.25	5	62.2
1N4763A	91	2.8	250	3000	0.25	5	69.2
1N4764A	100	2.5	350	3000	0.25	5	76.0

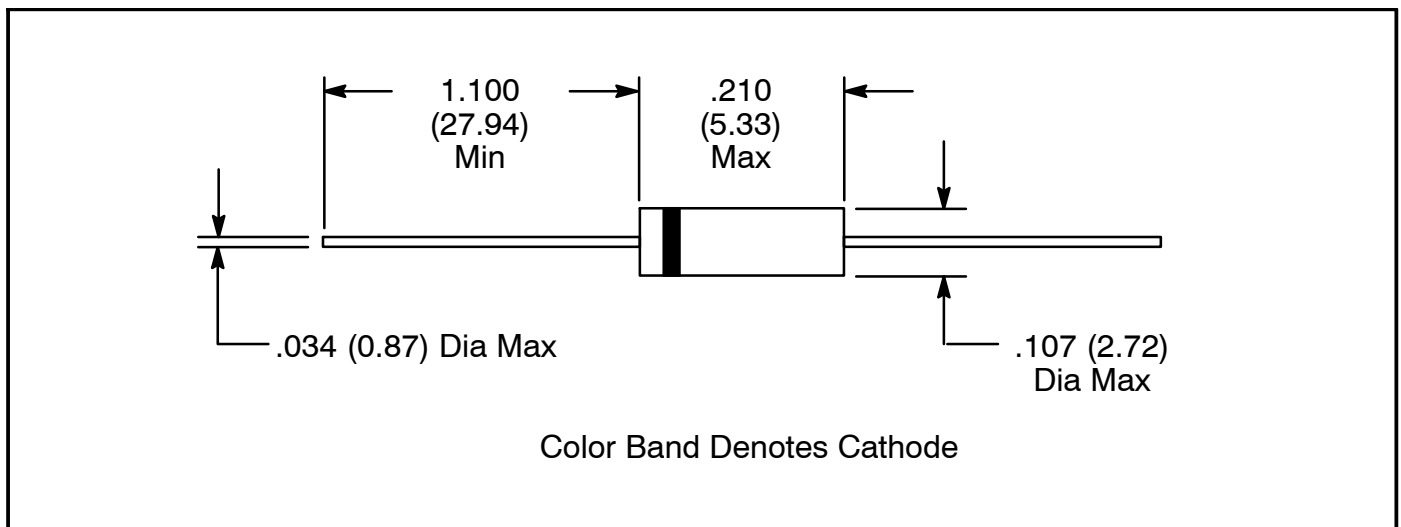

Looking for pricing, stock, or lifecycle information?

Click below to explore more details on WIN SOURCE:

 [View 1N4762A on WIN SOURCE](#)

 [NTE Information](#)

Optimize Your Supply Chain with WIN SOURCE Solutions

-  Global Sourcing Solution
-  Obsolete Management
-  Cost Control Management
-  Shortage Management
-  Alternative Solution
-  Excess Inventory Management