



**THE DATASHEET OF
TPS79301DBVREP**



ULTRALOW-NOISE, HIGH-PSRR, FAST RF 200-mA LOW-DROPOUT LINEAR REGULATORS

FEATURES

- **Controlled Baseline**
 - One Assembly/Test Site, One Fabrication Site
- **Enhanced Diminishing Manufacturing Sources (DMS) Support**
- **Enhanced Product-Change Notification**
- **Qualification Pedigree ⁽¹⁾**
- **200-mA Low-Dropout Regulator With EN**
- **Available in 1.8 V, 2.5 V, 2.8 V, 2.85 V, 3 V, 3.3 V, 4.75 V, and Adjustable**
- **High PSRR (70 dB at 10 kHz)**
- **Ultralow Noise (32 μ V)**
- **Fast Start-Up Time (50 μ s)**
- **Stable With a 2.2- μ F Ceramic Capacitor**
- **Excellent Load/Line Transient**
- **Very Low Dropout Voltage (112 mV at Full Load, TPS79330)**
- **5-Pin SOT23 (DBV) Package**

APPLICATIONS

- **VCOs**
- **RF**
- **Bluetooth™, Wireless LAN**

(1) Component qualification in accordance with JEDEC and industry standards to ensure reliable operation over specified temperature range. This includes, but is not limited to, Highly Accelerated Stress Test (HAST) or biased 85/85, temperature cycle, autoclave or unbiased HAST, electromigration, bond intermetallic life, and mold compound life. Such qualification testing should not be viewed as justifying use of this component beyond specified performance and environmental limits.

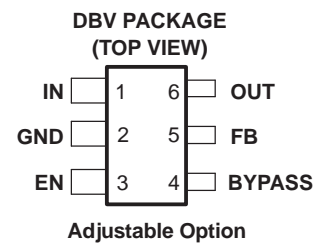
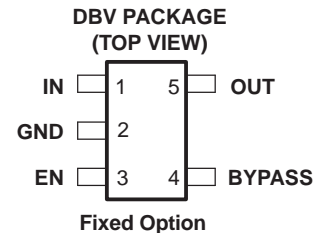

DESCRIPTION

The TPS793xx family of low-dropout (LDO) low-power linear voltage regulators features high power-supply rejection ratio (PSRR), ultralow noise, fast start-up, and excellent line and load transient responses in a small-outline SOT23 package. Each device in the family is stable, with a small 2.2- μ F ceramic capacitor on the output. The TPS793xx family uses an advanced, proprietary, BiCMOS fabrication process to yield extremely low dropout voltages (e.g., 112 mV at 200 mA, TPS79330). Each device achieves fast start-up times (approximately 50 μ s with a 0.001- μ F bypass capacitor), while consuming very low quiescent current (170 μ A typical). Moreover, when the device is placed in standby mode, the supply current is reduced to less than 1 μ A. The TPS79328 exhibits approximately 32 μ V_{RMS} of output voltage noise with a 0.1- μ F bypass capacitor. Applications with analog components that are noise sensitive, such as portable RF electronics, benefit from the high PSRR and low-noise features, as well as the fast response time.



Please be aware that an important notice concerning availability, standard warranty, and use in critical applications of Texas Instruments semiconductor products and disclaimers thereto appears at the end of this data sheet.

Bluetooth is a trademark of Bluetooth SIG, Inc.

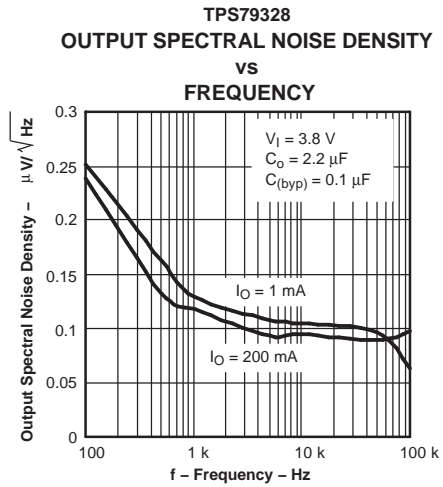
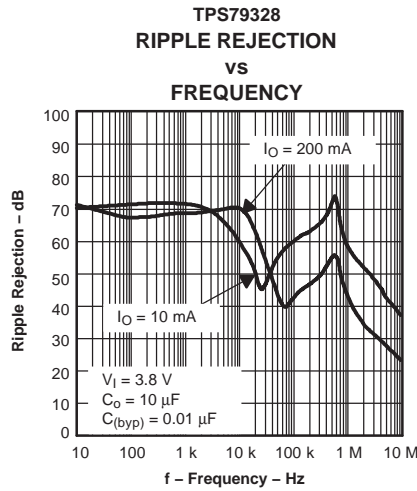

AVAILABLE OPTIONS

T _J	VOLTAGE	PACKAGE	PART NUMBER	SYMBOL
-40°C to 125°C	1.2 to 5.5 V	SOT23 (DBV)	TPS79301DBVREP ⁽¹⁾	PGVE
	1.8 V		TPS79318DBVREP ⁽¹⁾	PHHE
	2.5 V		TPS79325DBVREP ⁽¹⁾	PGWE
	2.8 V		TPS79328DBVREP ⁽¹⁾⁽²⁾	PGXE
	2.85 V		TPS793285DBVREP ⁽¹⁾⁽²⁾	PHIE
	3 V		TPS79330DBVREP ⁽¹⁾⁽²⁾	PGYE
	3.3 V		TPS79333DBVREP ⁽¹⁾	PHUE
	4.75 V		TPS793475DBVREP ⁽¹⁾	PHJE
-55°C to 125°C	1.2 to 5.5 V		TPS79301MDBVREP ⁽¹⁾	PMBM

- (1) The DBVR indicates tape and reel of 3000 parts.
 (2) Product preview

ABSOLUTE MAXIMUM RATINGS⁽¹⁾

over operating free-air temperature range (unless otherwise noted)

		MIN	MAX	UNIT
Input voltage range ⁽²⁾		-0.3	6	V
Voltage range at EN		-0.3	$V_I + 0.3$	V
Voltage on OUT		-0.3	6	V
Peak output current		Internally limited		
ESD rating	Human-Body Model (HBM)	2		kV
	Charged-Device Model (CDM)	500		V
Continuous total power dissipation		See Dissipation Rating Table		
T _J	Operating virtual junction temperature range	-55	125	°C
T _{stg}	Storage temperature range	-65	150	°C

- (1) Stresses beyond those listed under "absolute maximum ratings" may cause permanent damage to the device. These are stress ratings only, and functional operation of the device at these or any other conditions beyond those indicated under "recommended operating conditions" is not implied. Exposure to absolute-maximum-rated conditions for extended periods may affect device reliability.
- (2) All voltage values are with respect to network ground terminal

Dissipation Ratings

BOARD	PACKAGE	R _{θJC}	R _{θJA}	DERATING FACTOR ABOVE T _A = 25°C	T _A ≤ 25°C POWER RATING	T _A = 70°C POWER RATING	T _A = 85°C POWER RATING
Low K ⁽¹⁾	DBV	63.75°C/W	256°C/W	3.906 mW/°C	391 mW	215 mW	156 mW
High K ⁽²⁾	DBV	63.75°C/W	178.3°C/W	5.609 mW/°C	561 mW	308 mW	224 mW

- (1) The JEDEC low K (1s) board design used to derive this data was a 3-in × 3-in, two layer board with 2-oz copper traces on top of the board.
- (2) The JEDEC high K (2s2p) board design used to derive this data was a 3-in × 3-in, multilayer board with 1-oz internal power and ground planes and 2-oz copper traces on top and bottom of the board.

ELECTRICAL CHARACTERISTICS

over recommended operating free-air temperature range, $EN = V_I$, $T_J = -55$ to 125°C and $T_J = -40$ to 125°C , $V_I = V_{O(\text{typ})} + 1$ V, $I_O = 1$ mA, $C_O = 10$ μF , $C_{(\text{byp})} = 0.01$ μF (unless otherwise noted)

PARAMETER		TEST CONDITIONS		MIN	TYP	MAX	UNIT	
V_I	Input voltage ⁽¹⁾			2.7		5.5	V	
I_O	Continuous output current ⁽²⁾			0		200	mA	
T_J	Operating junction temperature			-55		125	$^\circ\text{C}$	
Output voltage	TPS79301	$0 \mu\text{A} < I_O < 200$ mA, $1.22 \text{ V} \leq V_O \leq 5.2 \text{ V}$ ⁽³⁾	$T_J = -40$ to 125°C ,	0.98 V_O		1.02 V_O	V	
		$0 \mu\text{A} < I_O < 200$ mA, $1.22 \text{ V} \leq V_O \leq 5.2 \text{ V}$ ⁽³⁾	$T_J = -55$ to 125°C ,	0.97 V_O		1.025 V_O		
	TPS79318	$T_J = 25^\circ\text{C}$			1.8			
		$0 \mu\text{A} < I_O < 200$ mA, $2.8 \text{ V} < V_I < 5.5 \text{ V}$			1.764			1.836
	TPS79325	$T_J = 25^\circ\text{C}$				2.5		
		$0 \mu\text{A} < I_O < 200$ mA, $3.5 \text{ V} < V_I < 5.5 \text{ V}$			2.45			2.55
	TPS79328	$T_J = 25^\circ\text{C}$				2.8		
		$0 \mu\text{A} < I_O < 200$ mA, $3.8 \text{ V} < V_I < 5.5 \text{ V}$			2.744			2.856
	TPS793285	$T_J = 25^\circ\text{C}$				2.85		
		$0 \mu\text{A} < I_O < 200$ mA, $3.85 \text{ V} < V_I < 5.5 \text{ V}$			2.793			2.907
	TPS79330	$T_J = 25^\circ\text{C}$				3		
		$0 \mu\text{A} < I_O < 200$ mA, $4 \text{ V} < V_I < 5.5 \text{ V}$			2.94			3.06
	TPS79333	$T_J = 25^\circ\text{C}$				3.3		
		$0 \mu\text{A} < I_O < 200$ mA, $4.3 \text{ V} < V_I < 5.5 \text{ V}$			3.234			3.366
TPS793475	$T_J = 25^\circ\text{C}$				4.75			
	$0 \mu\text{A} < I_O < 200$ mA, $5.25 \text{ V} < V_I < 5.5 \text{ V}$			4.655		4.845		
Quiescent current (GND current)	$0 \mu\text{A} < I_O < 200$ mA, $T_J = 25^\circ\text{C}$				170		μA	
	$0 \mu\text{A} < I_O < 200$ mA					220		
Load regulation	$0 \mu\text{A} < I_O < 200$ mA, $T_J = 25^\circ\text{C}$				5		mV	
Output voltage line regulation ($\Delta V_O/V_O$) ⁽⁴⁾	$V_O + 1 \text{ V} < V_I \leq 5.5 \text{ V}$, $T_J = 25^\circ\text{C}$				0.05		%V	
	$V_O + 1 \text{ V} < V_I \leq 5.5 \text{ V}$					0.12		
Output noise voltage (TPS79328)	$BW = 200$ Hz to 100 kHz, $I_O = 200$ mA, $T_J = 25^\circ\text{C}$	$C_{(\text{byp})} = 0.001$ μF			55		μV_{RMS}	
		$C_{(\text{byp})} = 0.0047$ μF			36			
		$C_{(\text{byp})} = 0.01$ μF			33			
		$C_{(\text{byp})} = 0.1$ μF			32			
Time, start-up (TPS79328)	$R_L = 14$ Ω , $C_O = 1$ μF , $T_J = 25^\circ\text{C}$	$C_{(\text{byp})} = 0.001$ μF			50		μs	
		$C_{(\text{byp})} = 0.0047$ μF			70			
		$C_{(\text{byp})} = 0.01$ μF			100			
Output current limit	$V_O = 0$ V ⁽³⁾			285		600	mA	
Standby current	$EN = 0$ V, $2.7 \text{ V} < V_I < 5.5 \text{ V}$				0.07	1	μA	
High-level enable input voltage	$2.7 \text{ V} < V_I < 5.5 \text{ V}$			2			V	
Low-level enable input voltage	$2.7 \text{ V} < V_I < 5.5 \text{ V}$					0.7	V	
Input current (EN)	$EN = 0$			-1		1	μA	

- To calculate the minimum input voltage for your maximum output current, use the following formula:
 $V_I(\text{min}) = V_O(\text{max}) + V_{DO}(\text{max load})$
- Continuous output current and operating junction temperature are limited by internal protection circuitry, but it is not recommended that the device operate under conditions beyond those specified in this table for extended periods of time.
- The minimum IN operating voltage is 2.7 V or $V_{O(\text{typ})} + 1$ V, whichever is greater. The maximum IN voltage is 5.5 V. The maximum output current is 200 mA.
- If $V_O \leq 2.5$ V, then $V_{I\text{min}} = 2.7$ V, $V_{I\text{max}} = 5.5$ V:

$$\text{Line Reg. (mV)} = (\%/\text{V}) \times \frac{V_O(V_{I\text{max}} - 2.7 \text{ V})}{100} \times 1000$$
 If $V_O \geq 2.5$ V, then $V_{I\text{min}} = V_O + 1$ V, $V_{I\text{max}} = 5.5$ V.

ELECTRICAL CHARACTERISTICS (continued)

over recommended operating free-air temperature range, $EN = V_I$, $T_J = -55$ to 125°C and $T_J = -40$ to 125°C , $V_I = V_{O(\text{typ})} + 1$ V, $I_O = 1$ mA, $C_O = 10$ μF , $C_{(\text{byp})} = 0.01$ μF (unless otherwise noted)

PARAMETER		TEST CONDITIONS	MIN	TYP	MAX	UNIT
Input current (FB) (TPS79301)		FB = 1.8 V			1	μA
Power-supply ripple rejection	TPS79328	f = 100 Hz, $T_J = 25^\circ\text{C}$, $I_O = 10$ mA		70		dB
		f = 100 Hz, $T_J = 25^\circ\text{C}$, $I_O = 200$ mA		68		
		f = 10 Hz, $T_J = 25^\circ\text{C}$, $I_O = 200$ mA		70		
		f = 100 Hz, $T_J = 25^\circ\text{C}$, $I_O = 200$ mA		43		
Dropout voltage ⁽⁵⁾	TPS79328	$I_O = 200$ mA, $T_J = 25^\circ\text{C}$		120		mV
		$I_O = 200$ mA			200	
	TPS793285	$I_O = 200$ mA, $T_J = 25^\circ\text{C}$		120		
		$I_O = 200$ mA			200	
	TPS79330	$I_O = 200$ mA, $T_J = 25^\circ\text{C}$		112		
		$I_O = 200$ mA			200	
	TPS79333	$I_O = 200$ mA, $T_J = 25^\circ\text{C}$		102		
		$I_O = 200$ mA			180	
	TPS793475	$I_O = 200$ mA, $T_J = 25^\circ\text{C}$		77		
		$I_O = 200$ mA			125	
UVLO threshold		V_{CC} rising	2.25		2.65	V
UVLO hysteresis		$T_J = 25^\circ\text{C}$ V_{CC} rising		100		mV

(5) IN voltage equals $V_{O(\text{typ})} - 100$ mV; The TPS79325 dropout voltage is limited by the input voltage range limitations.

DEVICE INFORMATION

FUNCTIONAL BLOCK DIAGRAM – ADJUSTABLE VERSION

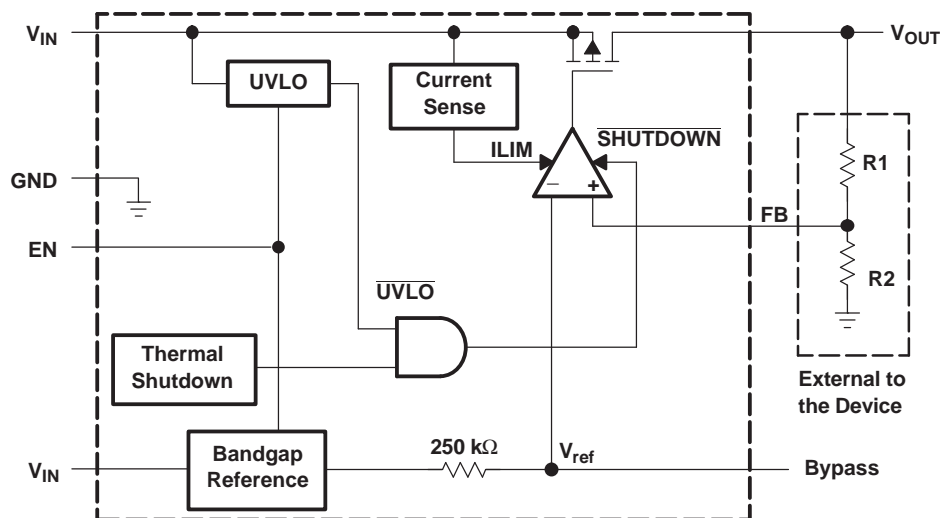

FUNCTIONAL BLOCK DIAGRAM – FIXED VERSION

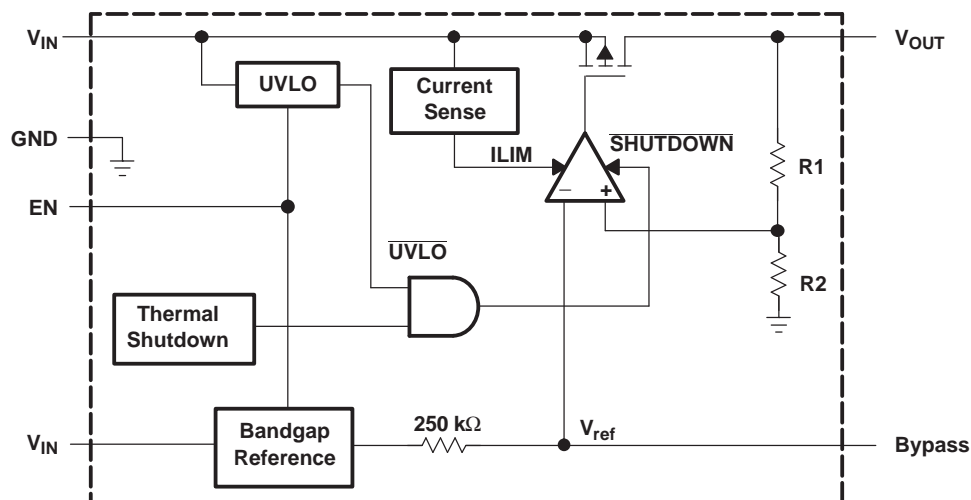

TERMINAL FUNCTIONS

TERMINAL			I/O	DESCRIPTION
NAME	ADJ	FIXED		
BYPASS	4	4		An external bypass capacitor, connected to this terminal, in conjunction with an internal resistor, creates a low-pass filter to further reduce regulator noise.
EN	3	3	I	Enable input that enables or shuts down the device. When EN goes to a logic high, the device is enabled. When the device goes to a logic low, the device is in shutdown mode.
FB	5	N/A	I	Feedback input voltage for the adjustable device
GND	2	2		Regulator ground
IN	1	1	I	Input to the device
OUT	6	5	O	Regulated output of the device

TYPICAL CHARACTERISTICS

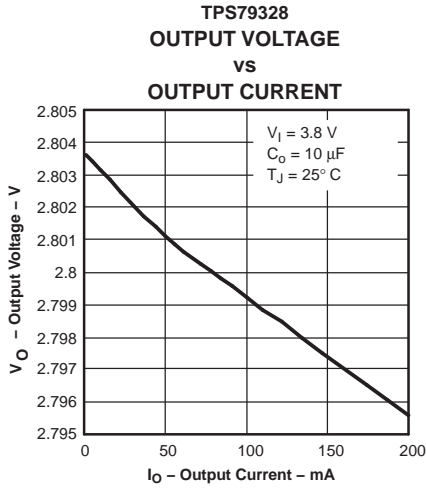

Figure 1.

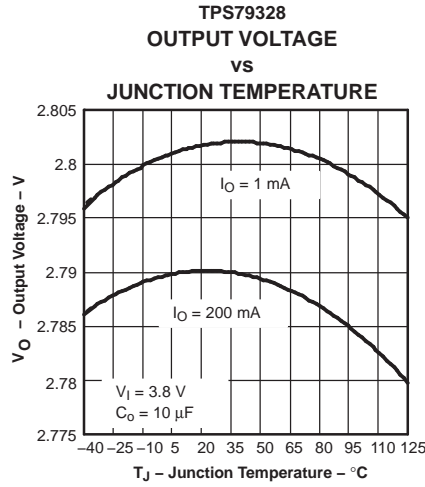

Figure 2.

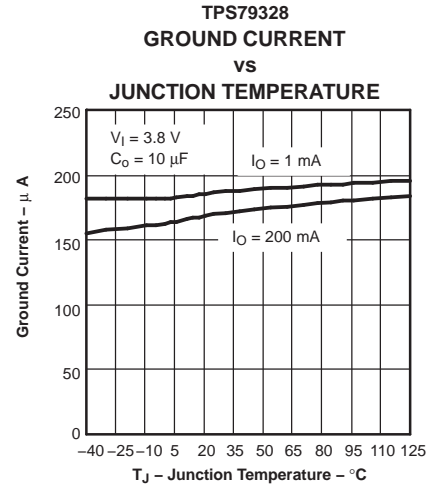

Figure 3.

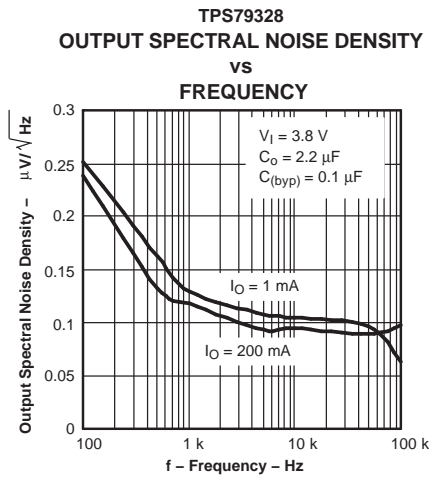

Figure 4.

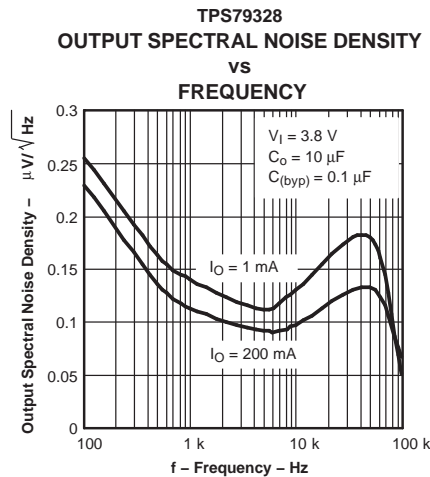

Figure 5.

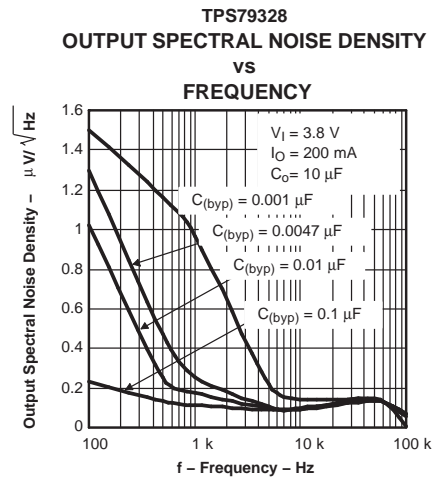

Figure 6.

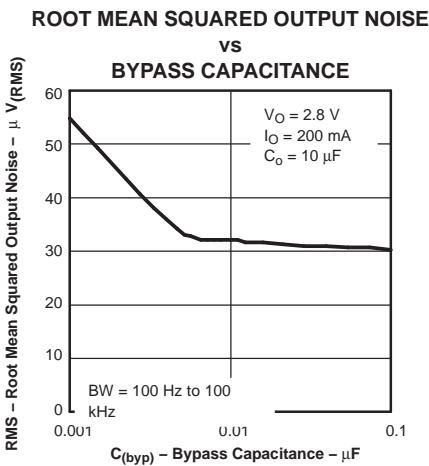

Figure 7.

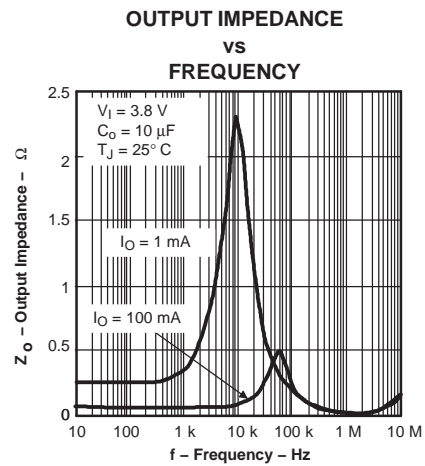

Figure 8.

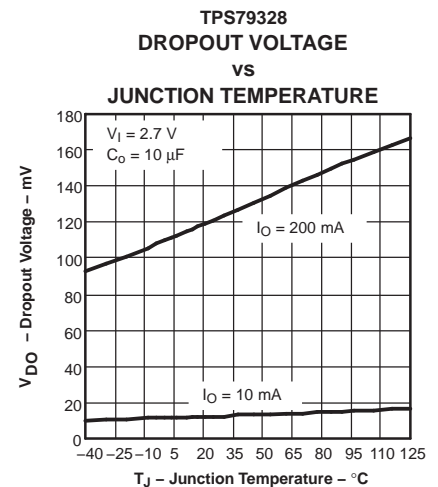

Figure 9.

TYPICAL CHARACTERISTICS (continued)

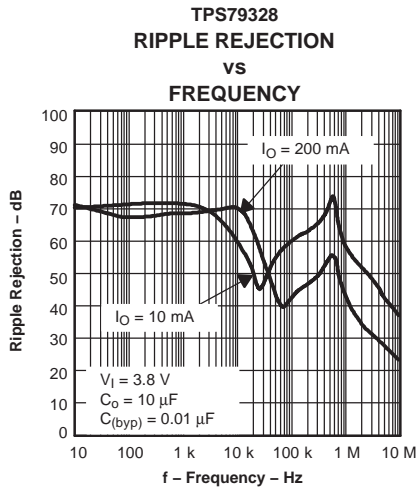

Figure 10.

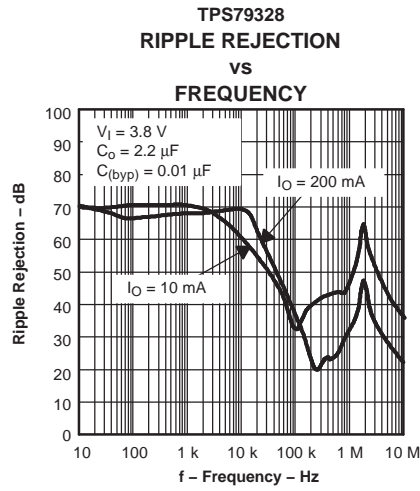

Figure 11.

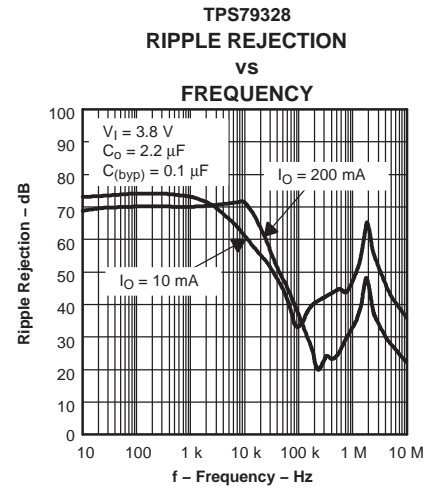

Figure 12.

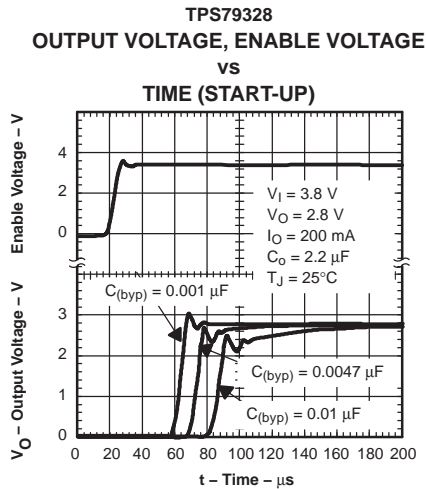

Figure 13.

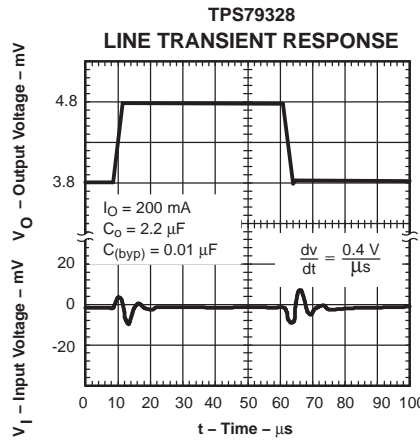

Figure 14.

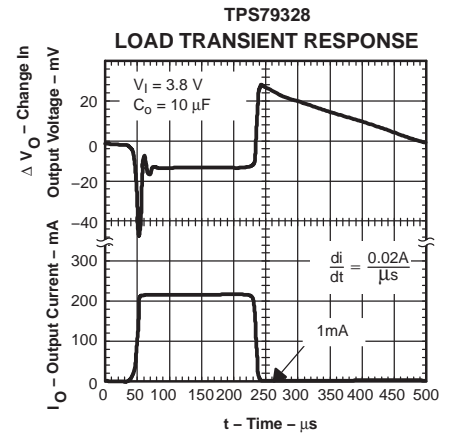

Figure 15.

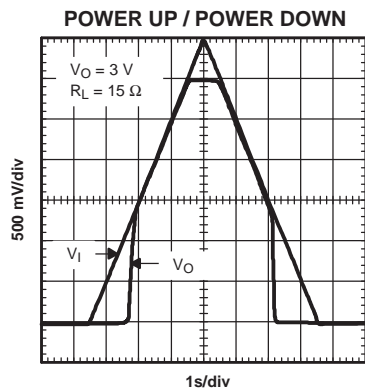

Figure 16.

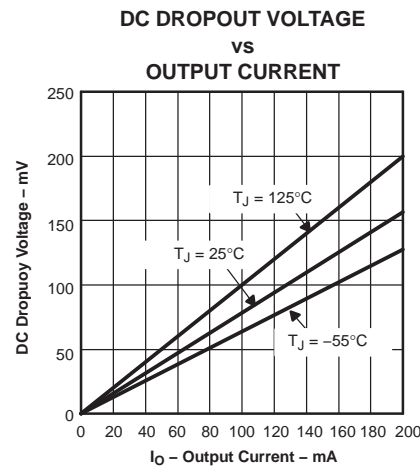

Figure 17.

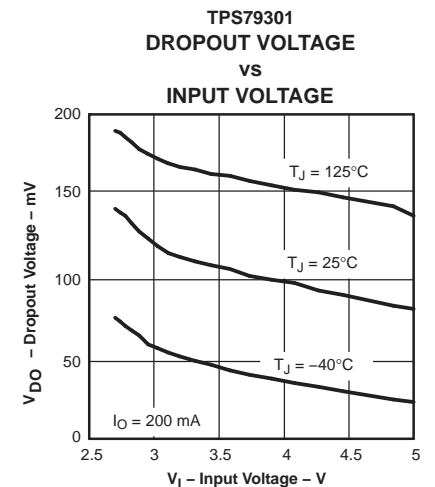

Figure 18.

TYPICAL CHARACTERISTICS (continued)

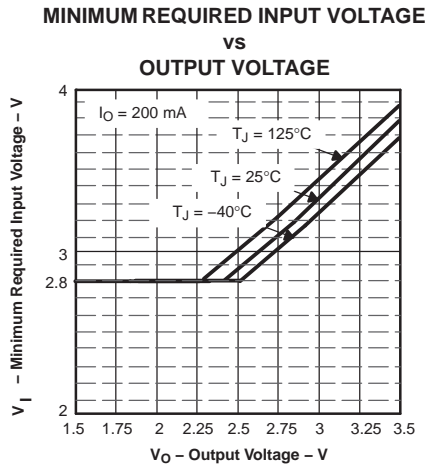

Figure 19.

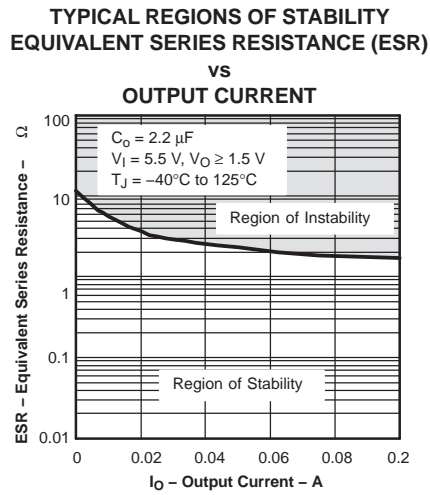

Figure 20.

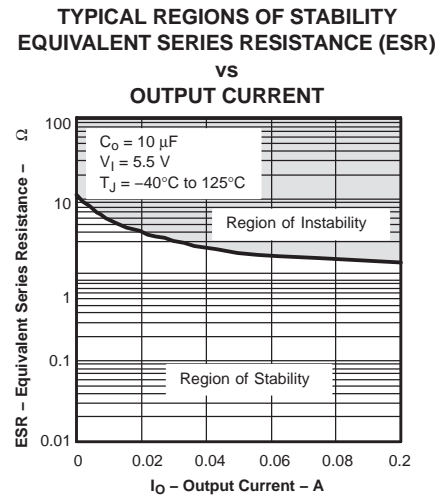

Figure 21.

APPLICATION INFORMATION

The TPS793xx family of low-dropout (LDO) regulators has been optimized for use in noise-sensitive battery-operated equipment. The device features extremely low dropout voltages, high PSRR, ultralow output noise, low quiescent current (170 μA typically), and enable-input to reduce supply currents to less than 1 μA when the regulator is turned off.

A typical application circuit is shown in [Figure 22](#).

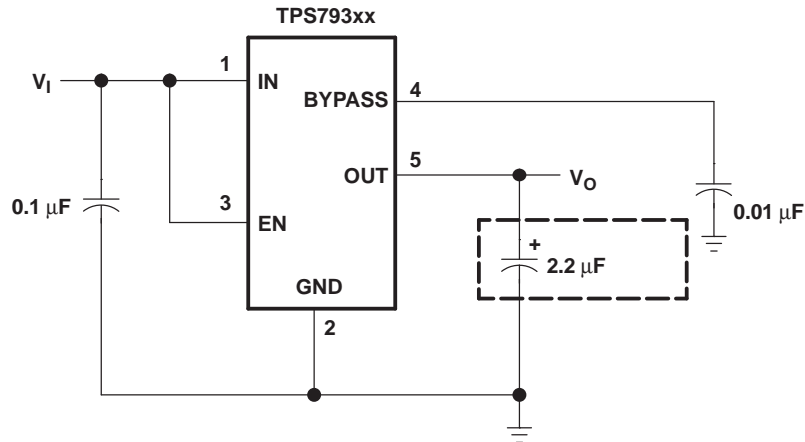

Figure 22. Typical Application Circuit

External Capacitor Requirements

A 0.1- μF or larger ceramic input bypass capacitor, connected between IN and GND and located close to the TPS793xx, is required for stability and improves transient response, noise rejection, and ripple rejection. A higher-value electrolytic input capacitor may be necessary if large, fast-rise-time load transients are anticipated and the device is located several inches from the power source.

Like all LDOs, the TPS793xx requires an output capacitor connected between OUT and GND to stabilize the internal control loop. The minimum recommended capacitance is 2.2- μF . Any 2.2- μF or larger ceramic capacitor is suitable, provided the capacitance does not vary significantly over temperature.

The internal voltage reference is a key source of noise in an LDO regulator. The TPS793xx has a BYPASS pin that is connected to the voltage reference through a 250-k Ω internal resistor. The 250-k Ω internal resistor, in conjunction with an external bypass capacitor connected to the BYPASS pin, creates a low pass filter to reduce the voltage reference noise and, therefore, the noise at the regulator output. In order for the regulator to operate properly, the current flow out of the BYPASS pin must be at a minimum, because any leakage current creates an IR drop across the internal resistor, thus, creating an output error. Therefore, the bypass capacitor must have minimal leakage current.

For example, the TPS79328 exhibits only 32 μV_{RMS} of output voltage noise using a 0.1- μF ceramic bypass capacitor and a 2.2- μF ceramic output capacitor. Note that the output starts up slower as the bypass capacitance increases due to the RC time constant at the BYPASS pin that is created by the internal 250-k Ω resistor and external capacitor.

Board Layout Recommendation to Improve PSRR and Noise Performance

To improve ac measurements like PSRR, output noise, and transient response, it is recommended that the board be designed with separate ground planes for V_{IN} and V_{OUT} , with each ground plane connected only at the GND pin of the device. In addition, the ground connection for the bypass capacitor should connect directly to the GND pin of the device.

APPLICATION INFORMATION (continued)

Power Dissipation and Junction Temperature

Specified regulator operation is ensured to a junction temperature of 125°C; the maximum junction temperature should be restricted to 125°C under normal operating conditions. This restriction limits the power dissipation the regulator can handle in any given application. To ensure the junction temperature is within acceptable limits, calculate the maximum allowable dissipation, $P_{D(max)}$, and the actual dissipation, P_D , which must be less than or equal to $P_{D(max)}$.

The maximum power dissipation limit is determined using the following equation:

$$P_{D(max)} = \frac{T_{Jmax} - T_A}{R_{\theta JA}} \quad (1)$$

Where:

T_{Jmax} = Maximum allowable junction temperature

$R_{\theta JA}$ = Thermal resistance, junction to ambient, for the package, see the dissipation rating table

T_A = Ambient temperature

The regulator dissipation is calculated using:

$$P_D = (V_I - V_O) \times I_O \quad (2)$$

Power dissipation resulting from quiescent current is negligible. Excessive power dissipation triggers the thermal protection circuit.

Programming the TPS79301 Adjustable LDO Regulator

The output voltage of the TPS79301 adjustable regulator is programmed using an external resistor divider as shown in [Figure 23](#). The output voltage is calculated using:

$$V_O = V_{ref} \times \left(1 + \frac{R1}{R2}\right) \quad (3)$$

Where:

V_{ref} = 1.2246 V typical (the internal reference voltage)

APPLICATION INFORMATION (continued)

Programming the TPS79301 Adjustable LDO Regulator (continued)

Resistors R1 and R2 should be chosen for approximately 50- μ A divider current. Lower-value resistors can be used for improved noise performance, but the solution consumes more power. Higher resistor values should be avoided as leakage current into/out of FB across R1/R2 creates an offset voltage that artificially increases/decreases the feedback voltage and, thus, erroneously decreases/increases V_O . The recommended design procedure is to choose $R_2 = 30.1 \text{ k}\Omega$ to set the divider current at 50 μ A, $C_1 = 15 \text{ pF}$ for stability, and then calculate R1 using:

$$R_1 = \left(\frac{V_O}{V_{\text{ref}}} - 1 \right) \times R_2 \quad (4)$$

In order to improve the stability of the adjustable version, it is suggested that a small compensation capacitor be placed between OUT and FB. For voltages <1.8 V, the value of this capacitor should be 100 pF. For voltages >1.8 V, the approximate value of this capacitor can be calculated as:

$$C_1 = \frac{(3 \times 10^{-7}) \times (R_1 + R_2)}{(R_1 \times R_2)} \quad (5)$$

The suggested value of this capacitor for several resistor ratios is shown in the table below. If this capacitor is not used (such as in a unity-gain configuration) or if an output voltage <1.8 V is chosen, then the minimum recommended output capacitor is 4.7 μ F instead of 2.2 μ F.

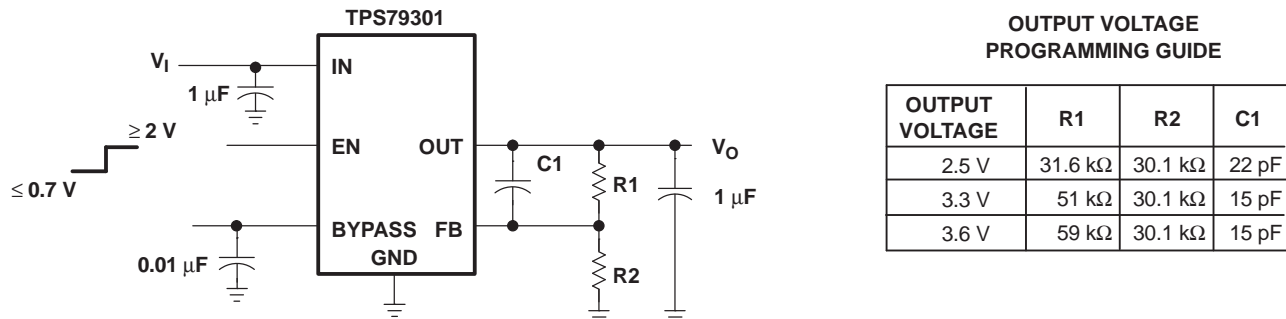

Figure 23. TPS79301 Adjustable LDO Regulator Programming

Regulator Protection

The TPS793xx features internal current limiting and thermal protection. During normal operation, the TPS793xx limits output current to approximately 400 mA. When current limiting engages, the output voltage scales back linearly until the overcurrent condition ends. While current limiting is designed to prevent gross device failure, care should be taken not to exceed the power dissipation ratings of the package or the absolute maximum voltage ratings of the device. If the temperature of the device exceeds approximately 165°C, thermal-protection circuitry shuts it down. Once the device has cooled down to below approximately 140°C, regulator operation resumes.

PACKAGING INFORMATION

Orderable Device	Status (1)	Package Type	Package Drawing	Pins	Package Qty	Eco Plan (2)	Lead finish/ Ball material (6)	MSL Peak Temp (3)	Op Temp (°C)	Device Marking (4/5)	Samples
TPS79301DBVREP	ACTIVE	SOT-23	DBV	6	3000	RoHS & Green	NIPDAU	Level-1-260C-UNLIM	-40 to 125	PGVE	Samples
TPS79301MDBVREP	ACTIVE	SOT-23	DBV	6	3000	RoHS & Green	NIPDAU	Level-1-260C-UNLIM	-40 to 125	PMBM	Samples
TPS79318DBVREP	ACTIVE	SOT-23	DBV	5	3000	RoHS & Green	NIPDAU	Level-1-260C-UNLIM	-40 to 125	PHHE	Samples
TPS79333DBVREP	ACTIVE	SOT-23	DBV	5	3000	RoHS & Green	NIPDAU	Level-1-260C-UNLIM	-40 to 125	PHUE	Samples
TPS793475DBVREP	ACTIVE	SOT-23	DBV	5	3000	RoHS & Green	NIPDAU	Level-1-260C-UNLIM	-40 to 125	PHJE	Samples
V62/03634-01YE	ACTIVE	SOT-23	DBV	6	3000	RoHS & Green	NIPDAU	Level-1-260C-UNLIM	-40 to 125	PGVE	Samples
V62/03634-02XE	ACTIVE	SOT-23	DBV	5	3000	RoHS & Green	NIPDAU	Level-1-260C-UNLIM	-40 to 125	PHHE	Samples
V62/03634-07XE	ACTIVE	SOT-23	DBV	5	3000	RoHS & Green	NIPDAU	Level-1-260C-UNLIM	-40 to 125	PHUE	Samples
V62/03634-08XE	ACTIVE	SOT-23	DBV	5	3000	RoHS & Green	NIPDAU	Level-1-260C-UNLIM	-40 to 125	PHJE	Samples
V62/03634-09XE	ACTIVE	SOT-23	DBV	6	3000	RoHS & Green	NIPDAU	Level-1-260C-UNLIM	-40 to 125	PMBM	Samples

(1) The marketing status values are defined as follows:

ACTIVE: Product device recommended for new designs.

LIFEBUY: TI has announced that the device will be discontinued, and a lifetime-buy period is in effect.

NRND: Not recommended for new designs. Device is in production to support existing customers, but TI does not recommend using this part in a new design.

PREVIEW: Device has been announced but is not in production. Samples may or may not be available.

OBSOLETE: TI has discontinued the production of the device.

(2) **RoHS:** TI defines "RoHS" to mean semiconductor products that are compliant with the current EU RoHS requirements for all 10 RoHS substances, including the requirement that RoHS substance do not exceed 0.1% by weight in homogeneous materials. Where designed to be soldered at high temperatures, "RoHS" products are suitable for use in specified lead-free processes. TI may reference these types of products as "Pb-Free".

RoHS Exempt: TI defines "RoHS Exempt" to mean products that contain lead but are compliant with EU RoHS pursuant to a specific EU RoHS exemption.

Green: TI defines "Green" to mean the content of Chlorine (Cl) and Bromine (Br) based flame retardants meet JS709B low halogen requirements of <=1000ppm threshold. Antimony trioxide based flame retardants must also meet the <=1000ppm threshold requirement.

(3) MSL, Peak Temp. - The Moisture Sensitivity Level rating according to the JEDEC industry standard classifications, and peak solder temperature.

(4) There may be additional marking, which relates to the logo, the lot trace code information, or the environmental category on the device.

⁽⁵⁾ Multiple Device Markings will be inside parentheses. Only one Device Marking contained in parentheses and separated by a "~" will appear on a device. If a line is indented then it is a continuation of the previous line and the two combined represent the entire Device Marking for that device.

⁽⁶⁾ Lead finish/Ball material - Orderable Devices may have multiple material finish options. Finish options are separated by a vertical ruled line. Lead finish/Ball material values may wrap to two lines if the finish value exceeds the maximum column width.

Important Information and Disclaimer:The information provided on this page represents TI's knowledge and belief as of the date that it is provided. TI bases its knowledge and belief on information provided by third parties, and makes no representation or warranty as to the accuracy of such information. Efforts are underway to better integrate information from third parties. TI has taken and continues to take reasonable steps to provide representative and accurate information but may not have conducted destructive testing or chemical analysis on incoming materials and chemicals. TI and TI suppliers consider certain information to be proprietary, and thus CAS numbers and other limited information may not be available for release.

In no event shall TI's liability arising out of such information exceed the total purchase price of the TI part(s) at issue in this document sold by TI to Customer on an annual basis.

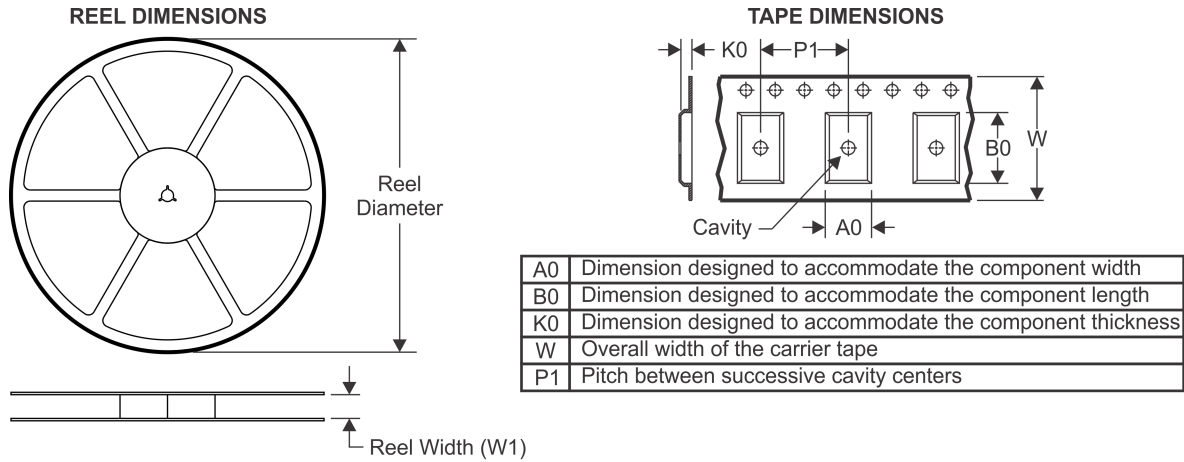
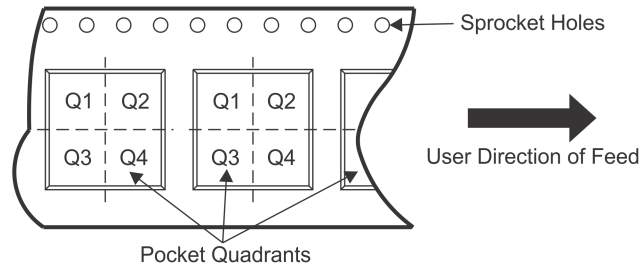
TAPE AND REEL INFORMATION

QUADRANT ASSIGNMENTS FOR PIN 1 ORIENTATION IN TAPE

*All dimensions are nominal

Device	Package Type	Package Drawing	Pins	SPQ	Reel Diameter (mm)	Reel Width W1 (mm)	A0 (mm)	B0 (mm)	K0 (mm)	P1 (mm)	W (mm)	Pin1 Quadrant
TPS79301DBVREP	SOT-23	DBV	6	3000	180.0	9.0	3.15	3.2	1.4	4.0	8.0	Q3
TPS79301MDBVREP	SOT-23	DBV	6	3000	179.0	8.4	3.2	3.2	1.4	4.0	8.0	Q3
TPS79318DBVREP	SOT-23	DBV	5	3000	180.0	9.0	3.15	3.2	1.4	4.0	8.0	Q3
TPS79333DBVREP	SOT-23	DBV	5	3000	180.0	9.0	3.15	3.2	1.4	4.0	8.0	Q3
TPS793475DBVREP	SOT-23	DBV	5	3000	180.0	9.0	3.15	3.2	1.4	4.0	8.0	Q3

TAPE AND REEL BOX DIMENSIONS



*All dimensions are nominal

Device	Package Type	Package Drawing	Pins	SPQ	Length (mm)	Width (mm)	Height (mm)
TPS79301DBVREP	SOT-23	DBV	6	3000	182.0	182.0	20.0
TPS79301MDBVREP	SOT-23	DBV	6	3000	200.0	183.0	25.0
TPS79318DBVREP	SOT-23	DBV	5	3000	182.0	182.0	20.0
TPS79333DBVREP	SOT-23	DBV	5	3000	182.0	182.0	20.0
TPS793475DBVREP	SOT-23	DBV	5	3000	182.0	182.0	20.0

EXAMPLE BOARD LAYOUT

DBV0006A

SOT-23 - 1.45 mm max height

SMALL OUTLINE TRANSISTOR



LAND PATTERN EXAMPLE
EXPOSED METAL SHOWN
SCALE:15X

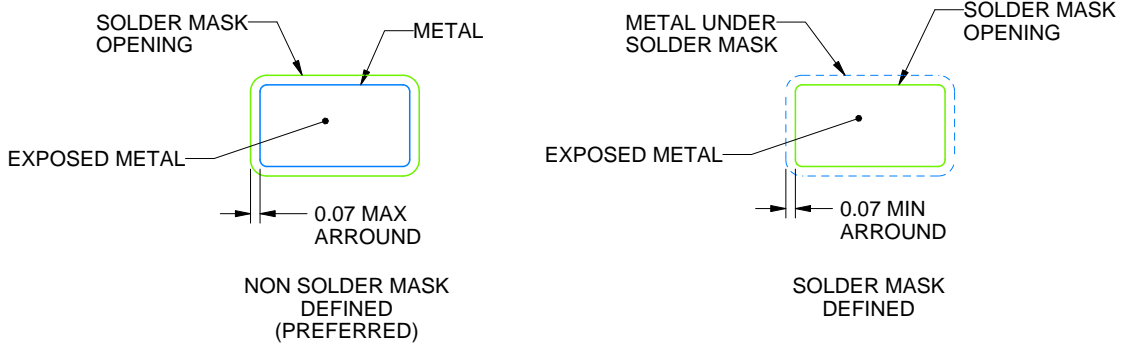

SOLDER MASK DETAILS

4214840/E 02/2024

NOTES: (continued)

- 6. Publication IPC-7351 may have alternate designs.
- 7. Solder mask tolerances between and around signal pads can vary based on board fabrication site.

EXAMPLE STENCIL DESIGN

DBV0006A

SOT-23 - 1.45 mm max height

SMALL OUTLINE TRANSISTOR

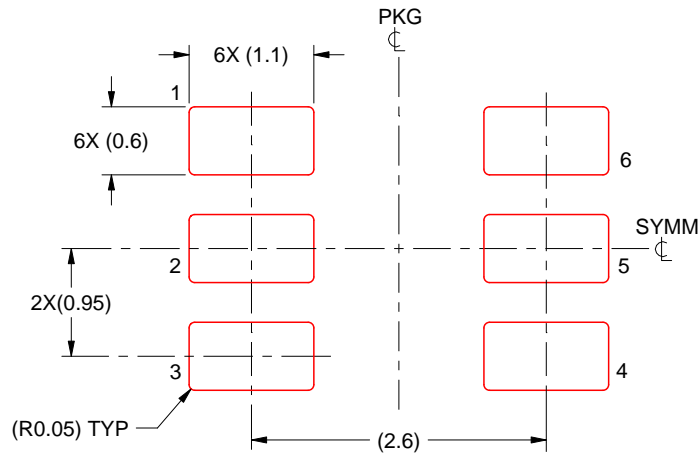

SOLDER PASTE EXAMPLE
BASED ON 0.125 mm THICK STENCIL
SCALE:15X

4214840/E 02/2024

NOTES: (continued)

8. Laser cutting apertures with trapezoidal walls and rounded corners may offer better paste release. IPC-7525 may have alternate design recommendations.
9. Board assembly site may have different recommendations for stencil design.

EXAMPLE BOARD LAYOUT

DBV0005A

SOT-23 - 1.45 mm max height

SMALL OUTLINE TRANSISTOR



LAND PATTERN EXAMPLE
EXPOSED METAL SHOWN
SCALE:15X

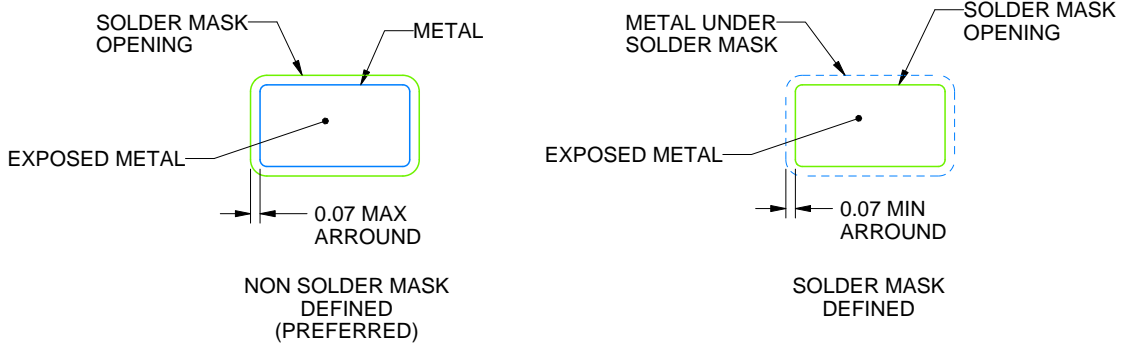

SOLDER MASK DETAILS

4214839/J 02/2024

NOTES: (continued)

- 6. Publication IPC-7351 may have alternate designs.
- 7. Solder mask tolerances between and around signal pads can vary based on board fabrication site.

EXAMPLE STENCIL DESIGN

DBV0005A

SOT-23 - 1.45 mm max height

SMALL OUTLINE TRANSISTOR



SOLDER PASTE EXAMPLE
BASED ON 0.125 mm THICK STENCIL
SCALE:15X

4214839/J 02/2024

NOTES: (continued)

8. Laser cutting apertures with trapezoidal walls and rounded corners may offer better paste release. IPC-7525 may have alternate design recommendations.
9. Board assembly site may have different recommendations for stencil design.

IMPORTANT NOTICE AND DISCLAIMER

TI PROVIDES TECHNICAL AND RELIABILITY DATA (INCLUDING DATA SHEETS), DESIGN RESOURCES (INCLUDING REFERENCE DESIGNS), APPLICATION OR OTHER DESIGN ADVICE, WEB TOOLS, SAFETY INFORMATION, AND OTHER RESOURCES "AS IS" AND WITH ALL FAULTS, AND DISCLAIMS ALL WARRANTIES, EXPRESS AND IMPLIED, INCLUDING WITHOUT LIMITATION ANY IMPLIED WARRANTIES OF MERCHANTABILITY, FITNESS FOR A PARTICULAR PURPOSE OR NON-INFRINGEMENT OF THIRD PARTY INTELLECTUAL PROPERTY RIGHTS.

These resources are intended for skilled developers designing with TI products. You are solely responsible for (1) selecting the appropriate TI products for your application, (2) designing, validating and testing your application, and (3) ensuring your application meets applicable standards, and any other safety, security, regulatory or other requirements.

These resources are subject to change without notice. TI grants you permission to use these resources only for development of an application that uses the TI products described in the resource. Other reproduction and display of these resources is prohibited. No license is granted to any other TI intellectual property right or to any third party intellectual property right. TI disclaims responsibility for, and you will fully indemnify TI and its representatives against, any claims, damages, costs, losses, and liabilities arising out of your use of these resources.

TI's products are provided subject to [TI's Terms of Sale](#) or other applicable terms available either on [ti.com](https://www.ti.com) or provided in conjunction with such TI products. TI's provision of these resources does not expand or otherwise alter TI's applicable warranties or warranty disclaimers for TI products.

TI objects to and rejects any additional or different terms you may have proposed.

Mailing Address: Texas Instruments, Post Office Box 655303, Dallas, Texas 75265
Copyright © 2024, Texas Instruments Incorporated

Looking for pricing, stock, or lifecycle information?

Click below to explore more details on WIN SOURCE:

 [View TPS79301DBVREP](#) on WIN SOURCE

 [Texas Instruments](#) Information

Optimize Your Supply Chain with WIN SOURCE Solutions

-  Global Sourcing Solution
-  Obsolete Management
-  Cost Control Management
-  Shortage Management
-  Alternative Solution
-  Excess Inventory Management