



THE DATASHEET OF TSM104WIPWR



FEATURES

- **OPERATIONAL AMPLIFIER**
 - Low Offset Voltage, Max of:
 - TSM104WA...3 mV (25°C) and 4 mV (Full Temperature)
 - TSM104W...5 mV (25°C) and 6 mV (Full Temperature)
 - Low Supply Current...375 μ A/Channel Typ at $V_{CC} = 5$ V
 - Unity Gain Bandwidth...0.9 MHz Typ
 - Input Common-Mode Range Includes GND
 - Large Output-Voltage Swing...0 V to $V_{CC} - 2$ V
 - Wide Supply-Voltage Range...3 V to 30 V
 - 2-kV ESD Protection (HBM)
- **VOLTAGE REFERENCE**
 - Adjustable Output Voltage... V_{REF} to 36 V
 - $V_{REF} = 2.5$ V With Tight Tolerance, Max of:
 - TSM104WA...0.4% (25°C) and 0.8% (Full Temperature)
 - TSM104W...1% (25°C) and 2% (Full Temperature)
 - Low Temperature Drift...7 mV Typ Over Operating Temperature Range
 - Wide Sink-Current Range...0.5 mA Typ to 100 mA
 - Output Impedance...0.2 Ω Typ

TYPICAL APPLICATIONS

- Battery Chargers
- Switch-Mode Power Supplies
- Linear Voltage Regulation
- Data-Acquisition Systems

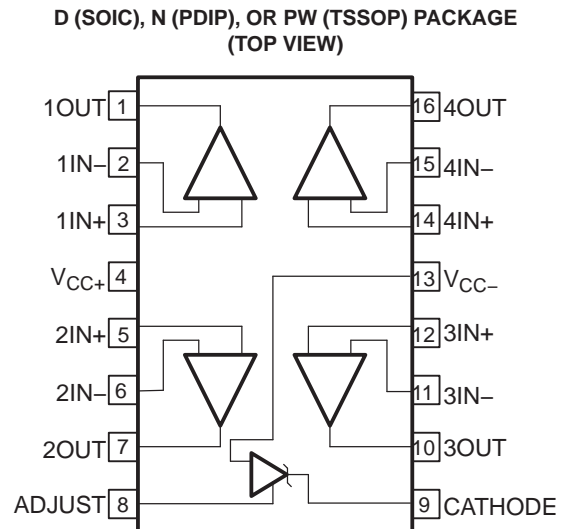

DESCRIPTION/ORDERING INFORMATION

The TSM104W combines the building blocks of a quad operational amplifier and an adjustable voltage reference, both of which often are used in the control circuitry of switch-mode power supplies.

For the A grade, especially tight voltage regulation can be achieved through the low offset voltage for each operational amplifier (typically 0.5 mV) and tight tolerance for the voltage reference (0.4% at 25°C and 0.8% over operating temperature range).

The TSM104W and TSM104WA are characterized for operation from -40°C to 105°C .



Please be aware that an important notice concerning availability, standard warranty, and use in critical applications of Texas Instruments semiconductor products and disclaimers thereto appears at the end of this data sheet.

TSM104W, TSM104WA QUAD OPERATIONAL AMPLIFIER AND PROGRAMMABLE VOLTAGE REFERENCE

SLOS478D–JULY 2005–REVISED AUGUST 2006

ORDERING INFORMATION

T_A	MAX V_{IO} AND V_{REF} TOLERANCE (25°C)	PACKAGE ⁽¹⁾		ORDERABLE PART NUMBER	TOP-SIDE MARKING
–40°C to 105°C	A grade 3 mV, 0.4%	PDIP – N	Tube of 25	TSM104WAIN	PREVIEW
		SOIC – D	Tube of 75	TSM104WAID	TSM104WAI
			Reel of 2500	TSM104WAIDR	
		TSSOP – PW	Tube of 75	TSM104WAIPW	SM104AI
			Reel of 2000	TSM104WAIPWR	
		Standard grade 5 mV, 1%	PDIP – N	Tube of 25	TSM104WIN
	SOIC – D		Tube of 75	TSM104WID	TSM104WI
			Reel of 2500	TSM104WIDR	
	TSSOP – PW		Tube of 75	TSM104WIPW	SM104I
			Reel of 2000	TSM104WIPWR	

(1) Package drawings, standard packing quantities, thermal data, symbolization, and PCB design guidelines are available at www.ti.com/sc/package.

Absolute Maximum Ratings⁽¹⁾

over free-air temperature range (unless otherwise noted)

		MIN	MAX	UNIT
V_{CC}	Supply voltage		36	V
V_{ID}	Operational amplifier input differential voltage		36	V
V_I	Operational amplifier input voltage range	–0.3	36	V
I_{KA}	Voltage reference cathode current		100	mA
θ_{JA}	Package thermal impedance ⁽²⁾⁽³⁾		73	°C/W
		D package	67	
		PW package	108	
T_J	Maximum junction temperature		150	°C
T_{stg}	Storage temperature range	–65	150	°C

- (1) Stresses beyond those listed under “absolute maximum ratings” may cause permanent damage to the device. These are stress ratings only, and functional operation of the device at these or any other conditions beyond those indicated under “recommended operating conditions” is not implied. Exposure to absolute-maximum-rated conditions for extended periods may affect device reliability.
- (2) Maximum power dissipation is a function of $T_J(\text{max})$, θ_{JA} , and T_A . The maximum allowable power dissipation at any allowable ambient temperature is $P_D = (T_J(\text{max}) - T_A)/\theta_{JA}$. Selecting the maximum of 150°C can affect reliability.
- (3) The package thermal impedance is calculated in accordance with JESD 51-7.

Recommended Operating Conditions

		MIN	MAX	UNIT
$V_{CC+} - V_{CC-}$	Supply voltage	3	30	V
I_K	Cathode current	1	100	mA
T_A	Operating free-air temperature	–40	105	°C

Total Device Electrical Characteristics

PARAMETER		TEST CONDITIONS	T _A	MIN	TYP	MAX	UNIT
I _{CC}	Total supply current, excluding cathode-current reference	V _{CC+} = 5 V, No load	Full range		1.4	2.4	mA
		V _{CC+} = 30 V, No load					

Operational Amplifier Electrical Characteristics

 V_{CC+} = 5 V, V_{CC-} = GND, V_O = 1.4 V, T_A = 25°C (unless otherwise noted)

PARAMETER		TEST CONDITIONS	T _A	MIN	TYP	MAX	UNIT
V _{IO}	Input offset voltage	TSM104W	25°C		1	5	mV
			Full range			6	
		TSM104WA	25°C		0.5	3	
			Full range			4	
αV _{IO}	Input offset voltage drift		25°C		7	μV/°C	
I _{IO}	Input offset current		25°C		2	30	nA
			Full range			50	
I _{IB}	Input bias current		25°C		30	150	nA
			Full range			200	
A _{VD}	Large-signal voltage gain	V _{CC+} = 15 V, R _L = 2 kΩ, V _O = 1.4 V to 11.4 V	25°C	50	100		V/mV
			Full range		25		
k _{SVR}	Supply-voltage rejection ratio	V _{CC+} = 5 V to 30 V	25°C	65	100		dB
V _{ICR}	Input common-mode voltage range	V _{CC+} = 30 V ⁽¹⁾	25°C	0		V _{CC+} – 1.5	V
			Full range		0		
CMRR	Common-mode rejection ratio		25°C	70	85		dB
			Full range		60		
I _{source}	Output source current	V _{CC+} = 15 V, V _O = 2 V, V _{id} = 1 V	25°C	20	40		mA
I _{SC}	Short circuit to GND	V _{CC+} = 15 V	25°C		40	60	mA
I _{sink}	Output sink current	V _{CC+} = 15 V, V _O = 2 V, V _{id} = –1 V	25°C	10	20		mA
V _{OH}	High-level output voltage	V _{CC+} = 30 V, R _L = 10 kΩ	25°C	27	28		V
			Full range		27		
V _{OL}	Low-level output voltage	R _L = 10 kΩ	25°C		5	20	mV
			Full range			20	
SR	Slew rate at unity gain	V _{CC+} = 15 V, C _L = 100 pF, R _L = 2 kΩ, V _I = 0.5 V to 3 V, unity gain	25°C	0.1	0.3		V/μs
GBW	Gain bandwidth product	V _{CC+} = 30 V, V _I = 10 mV, C _L = 100 pF, R _L = 2 kΩ, f = 100 kHz	25°C	0.5	0.9		MHz
THD	Total harmonic distortion	V _{CC+} = 30 V, V _O = 2 V _{pp} , C _L = 100 pF, R _L = 2 kΩ, f = 1 kHz, A _V = 20 dB	25°C		0.01		%
V _n	Equivalent input noise voltage	V _{CC} = 30 V, R _S = 100 Ω, f = 1 kHz	25°C		25		nV/√Hz
	Channel separation	1 kHz < f < 20 kHz	25°C		120		dB

(1) The input common-mode voltage of either input should not be allowed to go below –0.3 V. The upper end of the common-mode voltage range is V_{CC+} – 1.5 V, but either input can go to V_{CC+} + 0.3 V without damage (absolute maximum ratings still must be observed).

TSM104W, TSM104WA QUAD OPERATIONAL AMPLIFIER AND PROGRAMMABLE VOLTAGE REFERENCE

SLOS478D–JULY 2005–REVISED AUGUST 2006

Voltage Reference Electrical Characteristics

PARAMETER		TEST CONDITIONS	T _A	MIN	TYP	MAX	UNIT
V _{REF}	Reference voltage	TSM104W I _K = 10 mA	25°C	2.475	2.5	2.525	V
			Full range	2.45		2.55	
		TSM104WA I _K = 10 mA	25°C	2.49	2.5	2.51	
			Full range	2.48		2.52	
ΔV _{REF}	Reference input voltage deviation over temperature range	V _{KA} = V _{REF} , I _K = 10 mA	Full range		7	30	mV
$\frac{\Delta V_{REF}}{\Delta V_{KA}}$	Ratio of change in reference voltage to change in cathode voltage	V _{KA} = 3 V to 36 V, I _K = 10 mA	25°C	–2	–1.1		mV/V
I _{REF}	Reference input current	I _K = 10 mA	25°C		1.5	2.5	μA
			Full range			3	
ΔI _{REF}	Reference input current deviation over temperature range		Full range		0.8	1.2	μA
I _{min}	Minimum cathode current for regulation	V _{KA} = V _{REF}	25°C		0.5	1	mA
I _{K,OFF}	Off-state cathode current		25°C		180	500	nA
z _{ka}	Dynamic impedance ⁽¹⁾	V _{KA} = V _{REF} , f < 1 kHz, ΔI _K = 1 mA to 100 mA	25°C		0.2	0.5	Ω

(1) The dynamic impedance is defined as $|z_{ka}| = \frac{\Delta V_{KA}}{\Delta I_K}$.

TYPICAL OPERATING CHARACTERISTICS

$T_A = 25^\circ\text{C}$ (unless otherwise noted)

**TOTAL HARMONIC DISTORTION (THD)
vs
FREQUENCY**

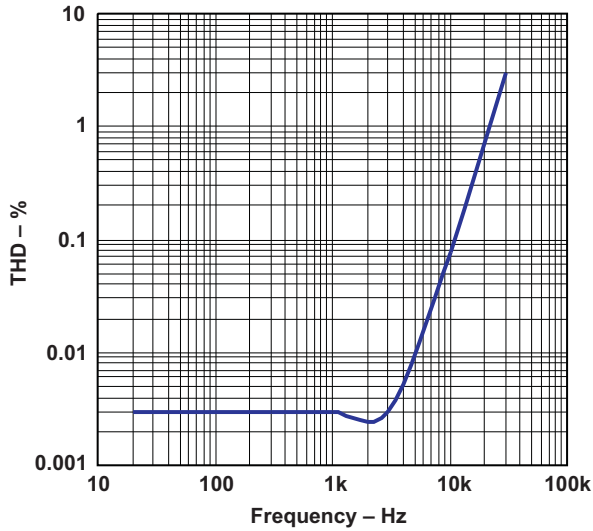

Figure 1.

**AMPLIFIER NOISE VOLTAGE
vs
FREQUENCY**

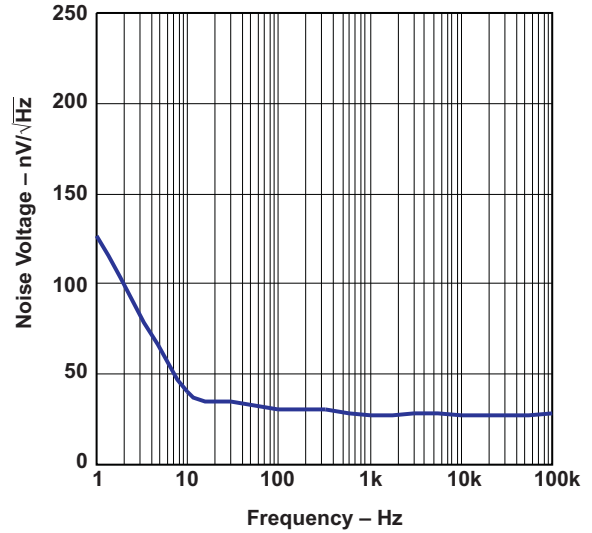

Figure 2.

**I_K
vs
 V_{REF}**

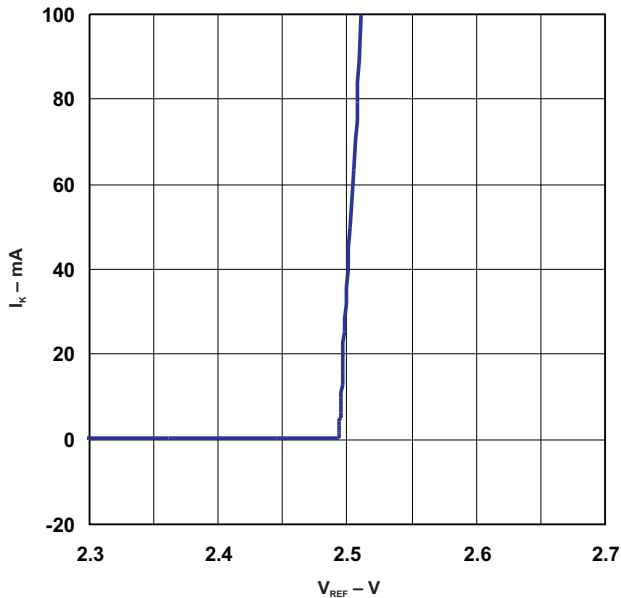

Figure 3.

**V_{REF} STABILITY
vs
CAPACITANCE**

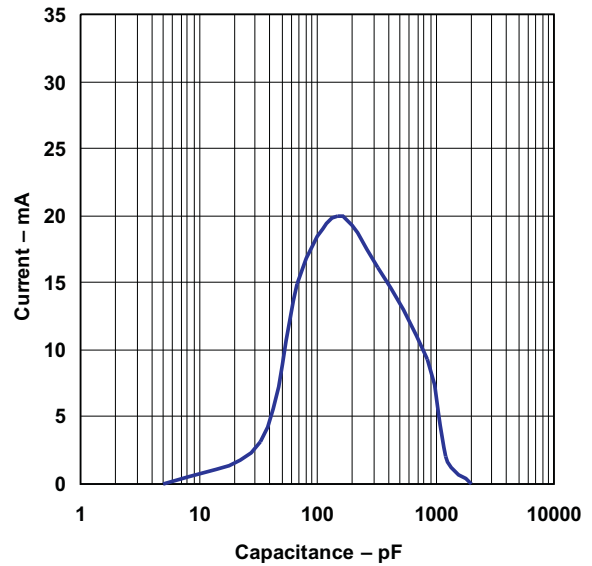

Figure 4.

TYPICAL OPERATING CHARACTERISTICS (continued)

$T_A = 25^\circ\text{C}$ (unless otherwise noted)

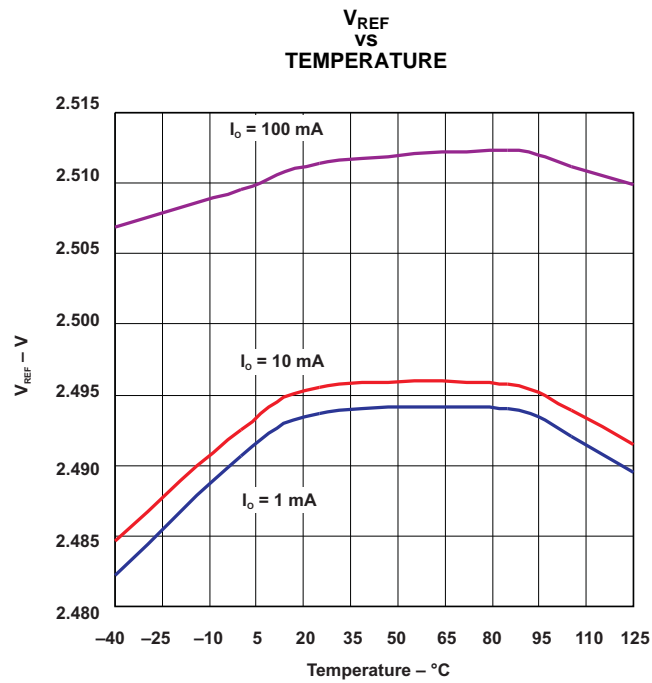

Figure 5.

PACKAGING INFORMATION

Orderable Device	Status (1)	Package Type	Package Drawing	Pins	Package Qty	Eco Plan (2)	Lead finish/ Ball material (6)	MSL Peak Temp (3)	Op Temp (°C)	Device Marking (4/5)	Samples
TSM104WAID	ACTIVE	SOIC	D	16	40	RoHS & Green	NIPDAU	Level-1-260C-UNLIM	-40 to 105	TSM104WAI	Samples
TSM104WAIDR	ACTIVE	SOIC	D	16	2500	RoHS & Green	NIPDAU	Level-1-260C-UNLIM	-40 to 105	TSM104WAI	Samples
TSM104WAIPWR	ACTIVE	TSSOP	PW	16	2000	RoHS & Green	NIPDAU	Level-1-260C-UNLIM	-40 to 105	SM104AI	Samples
TSM104WIDR	ACTIVE	SOIC	D	16	2500	RoHS & Green	NIPDAU	Level-1-260C-UNLIM	-40 to 105	TSM104WI	Samples
TSM104WIPWR	ACTIVE	TSSOP	PW	16	2000	RoHS & Green	NIPDAU	Level-1-260C-UNLIM	-40 to 105	SM104I	Samples

(1) The marketing status values are defined as follows:

ACTIVE: Product device recommended for new designs.

LIFEBUY: TI has announced that the device will be discontinued, and a lifetime-buy period is in effect.

NRND: Not recommended for new designs. Device is in production to support existing customers, but TI does not recommend using this part in a new design.

PREVIEW: Device has been announced but is not in production. Samples may or may not be available.

OBSELETE: TI has discontinued the production of the device.

(2) **RoHS:** TI defines "RoHS" to mean semiconductor products that are compliant with the current EU RoHS requirements for all 10 RoHS substances, including the requirement that RoHS substance do not exceed 0.1% by weight in homogeneous materials. Where designed to be soldered at high temperatures, "RoHS" products are suitable for use in specified lead-free processes. TI may reference these types of products as "Pb-Free".

RoHS Exempt: TI defines "RoHS Exempt" to mean products that contain lead but are compliant with EU RoHS pursuant to a specific EU RoHS exemption.

Green: TI defines "Green" to mean the content of Chlorine (Cl) and Bromine (Br) based flame retardants meet JS709B low halogen requirements of <=1000ppm threshold. Antimony trioxide based flame retardants must also meet the <=1000ppm threshold requirement.

(3) MSL, Peak Temp. - The Moisture Sensitivity Level rating according to the JEDEC industry standard classifications, and peak solder temperature.

(4) There may be additional marking, which relates to the logo, the lot trace code information, or the environmental category on the device.

(5) Multiple Device Markings will be inside parentheses. Only one Device Marking contained in parentheses and separated by a "~" will appear on a device. If a line is indented then it is a continuation of the previous line and the two combined represent the entire Device Marking for that device.

(6) Lead finish/Ball material - Orderable Devices may have multiple material finish options. Finish options are separated by a vertical ruled line. Lead finish/Ball material values may wrap to two lines if the finish value exceeds the maximum column width.

Important Information and Disclaimer: The information provided on this page represents TI's knowledge and belief as of the date that it is provided. TI bases its knowledge and belief on information provided by third parties, and makes no representation or warranty as to the accuracy of such information. Efforts are underway to better integrate information from third parties. TI has taken and continues to take reasonable steps to provide representative and accurate information but may not have conducted destructive testing or chemical analysis on incoming materials and chemicals. TI and TI suppliers consider certain information to be proprietary, and thus CAS numbers and other limited information may not be available for release.

In no event shall TI's liability arising out of such information exceed the total purchase price of the TI part(s) at issue in this document sold by TI to Customer on an annual basis.

TAPE AND REEL INFORMATION

QUADRANT ASSIGNMENTS FOR PIN 1 ORIENTATION IN TAPE



*All dimensions are nominal

Device	Package Type	Package Drawing	Pins	SPQ	Reel Diameter (mm)	Reel Width W1 (mm)	A0 (mm)	B0 (mm)	K0 (mm)	P1 (mm)	W (mm)	Pin1 Quadrant
TSM104WAIDR	SOIC	D	16	2500	330.0	16.4	6.5	10.3	2.1	8.0	16.0	Q1
TSM104WAIPWR	TSSOP	PW	16	2000	330.0	12.4	6.9	5.6	1.6	8.0	12.0	Q1
TSM104WIDR	SOIC	D	16	2500	330.0	16.4	6.5	10.3	2.1	8.0	16.0	Q1
TSM104WIPWR	TSSOP	PW	16	2000	330.0	12.4	6.9	5.6	1.6	8.0	12.0	Q1

TAPE AND REEL BOX DIMENSIONS

*All dimensions are nominal

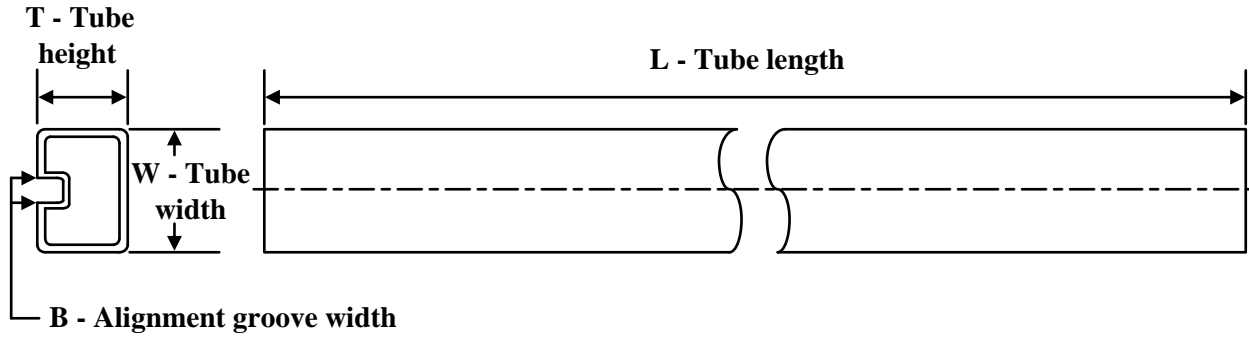
Device	Package Type	Package Drawing	Pins	SPQ	Length (mm)	Width (mm)	Height (mm)
TSM104WAIDR	SOIC	D	16	2500	356.0	356.0	35.0
TSM104WAIPWR	TSSOP	PW	16	2000	356.0	356.0	35.0
TSM104WIDR	SOIC	D	16	2500	356.0	356.0	35.0
TSM104WIPWR	TSSOP	PW	16	2000	356.0	356.0	35.0

TUBE

*All dimensions are nominal

Device	Package Name	Package Type	Pins	SPQ	L (mm)	W (mm)	T (μm)	B (mm)
TSM104WAID	D	SOIC	16	40	506.6	8	3940	4.32

D (R-PDSO-G16)

PLASTIC SMALL OUTLINE



4040047-6/M 06/11

- NOTES:
- A. All linear dimensions are in inches (millimeters).
 - B. This drawing is subject to change without notice.
 -  Body length does not include mold flash, protrusions, or gate burrs. Mold flash, protrusions, or gate burrs shall not exceed 0.006 (0,15) each side.
 -  Body width does not include interlead flash. Interlead flash shall not exceed 0.017 (0,43) each side.
 - E. Reference JEDEC MS-012 variation AC.



NOTES:

1. All linear dimensions are in millimeters. Any dimensions in parenthesis are for reference only. Dimensioning and tolerancing per ASME Y14.5M.
2. This drawing is subject to change without notice.
3. This dimension does not include mold flash, protrusions, or gate burrs. Mold flash, protrusions, or gate burrs shall not exceed 0.15 mm per side.
4. This dimension does not include interlead flash. Interlead flash shall not exceed 0.25 mm per side.
5. Reference JEDEC registration MO-153.

EXAMPLE BOARD LAYOUT

PW0016A

TSSOP - 1.2 mm max height

SMALL OUTLINE PACKAGE



LAND PATTERN EXAMPLE
EXPOSED METAL SHOWN
SCALE: 10X



SOLDER MASK DETAILS

4220204/A 02/2017

NOTES: (continued)

- 6. Publication IPC-7351 may have alternate designs.
- 7. Solder mask tolerances between and around signal pads can vary based on board fabrication site.

EXAMPLE STENCIL DESIGN

PW0016A

TSSOP - 1.2 mm max height

SMALL OUTLINE PACKAGE



SOLDER PASTE EXAMPLE
BASED ON 0.125 mm THICK STENCIL
SCALE: 10X

4220204/A 02/2017

NOTES: (continued)

8. Laser cutting apertures with trapezoidal walls and rounded corners may offer better paste release. IPC-7525 may have alternate design recommendations.
9. Board assembly site may have different recommendations for stencil design.

IMPORTANT NOTICE AND DISCLAIMER

TI PROVIDES TECHNICAL AND RELIABILITY DATA (INCLUDING DATA SHEETS), DESIGN RESOURCES (INCLUDING REFERENCE DESIGNS), APPLICATION OR OTHER DESIGN ADVICE, WEB TOOLS, SAFETY INFORMATION, AND OTHER RESOURCES "AS IS" AND WITH ALL FAULTS, AND DISCLAIMS ALL WARRANTIES, EXPRESS AND IMPLIED, INCLUDING WITHOUT LIMITATION ANY IMPLIED WARRANTIES OF MERCHANTABILITY, FITNESS FOR A PARTICULAR PURPOSE OR NON-INFRINGEMENT OF THIRD PARTY INTELLECTUAL PROPERTY RIGHTS.

These resources are intended for skilled developers designing with TI products. You are solely responsible for (1) selecting the appropriate TI products for your application, (2) designing, validating and testing your application, and (3) ensuring your application meets applicable standards, and any other safety, security, regulatory or other requirements.

These resources are subject to change without notice. TI grants you permission to use these resources only for development of an application that uses the TI products described in the resource. Other reproduction and display of these resources is prohibited. No license is granted to any other TI intellectual property right or to any third party intellectual property right. TI disclaims responsibility for, and you will fully indemnify TI and its representatives against, any claims, damages, costs, losses, and liabilities arising out of your use of these resources.

TI's products are provided subject to [TI's Terms of Sale](#) or other applicable terms available either on [ti.com](https://www.ti.com) or provided in conjunction with such TI products. TI's provision of these resources does not expand or otherwise alter TI's applicable warranties or warranty disclaimers for TI products.

TI objects to and rejects any additional or different terms you may have proposed.

Mailing Address: Texas Instruments, Post Office Box 655303, Dallas, Texas 75265
Copyright © 2024, Texas Instruments Incorporated

Looking for pricing, stock, or lifecycle information?

Click below to explore more details on WIN SOURCE:

 [View TSM104WIPWR on WIN SOURCE](#)

 [Texas Instruments](#) Information

Optimize Your Supply Chain with WIN SOURCE Solutions

-  Global Sourcing Solution
-  Obsolete Management
-  Cost Control Management
-  Shortage Management
-  Alternative Solution
-  Excess Inventory Management