



THE DATASHEET OF LMH0024MA/NOPB



LMH0024

LMH0024 3.3V SMPTE 259M / 344M Adaptive Cable Equalizer



Literature Number: SNLS210F

LMH0024

3.3V SMPTE 259M / 344M Adaptive Cable Equalizer

General Description

The LMH0024 SMPTE 259M / 344M adaptive cable equalizer is a monolithic integrated circuit for equalizing data transmitted over cable (or any media with similar dispersive loss characteristics). The equalizer operates over a wide range of data rates from 125 Mbps to 540 Mbps and supports SMPTE 259M and SMPTE 344M.

The LMH0024 implements DC restoration to correctly handle pathological data conditions. DC restoration can be bypassed for low data rate applications. The equalizer is flexible in allowing either single-ended or differential input drive.

Additional features include a mute pin which can be used to manually mute the output and a cable length indicator which determines the amount of cable being equalized.

Features

- SMPTE 259M and SMPTE 344M compliant
- Supports DVB-ASI at 270 Mbps
- Data rates: 125 Mbps to 540 Mbps
- Equalizes up to 350 meters of Belden 1694A at 270 Mbps
- Manual bypass, cable length indicator, and output mute
- Single-ended or differential input
- 50Ω differential outputs
- Single 3.3V supply operation
- Industrial temperature range: -40°C to +85°C
- 198 mW typical power consumption with 3.3V supply
- Footprint compatible with the LMH0034 and the GS9064

Applications

- SMPTE 259M and SMPTE 344M serial digital interfaces
- Serial digital data equalization and reception
- Data recovery equalization

Typical Application

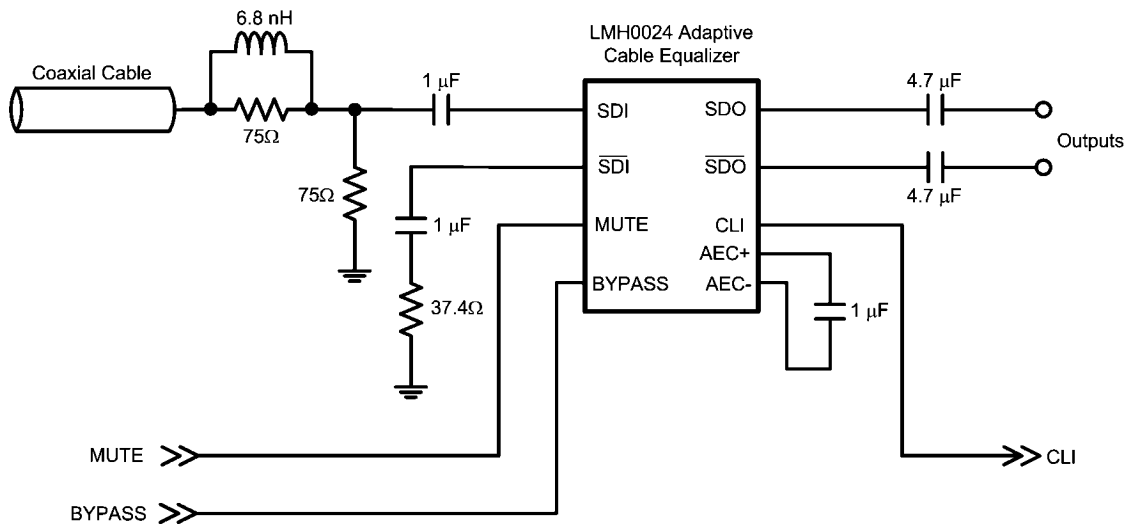

20172501

Absolute Maximum Ratings *(Note 1)*

Supply Voltage	-0.5V to 3.6V
Input Voltage (all inputs)	-0.3V to $V_{CC}+0.3V$
Storage Temperature Range	-65°C to +150°C
Junction Temperature	+150°C
Lead Temperature (Soldering 4 Sec)	+260°C
Package Thermal Resistance	
θ_{JA} 16-pin SOIC	+115°C/W
θ_{JC} 16-pin SOIC	+105°C/W
ESD Rating (HBM)	8 kV
ESD Rating (MM)	250V

Recommended Operating Conditions

Supply Voltage ($V_{CC} - V_{EE}$)	3.3V \pm 5%
Input Coupling Capacitance	1.0 μ F
AEC Capacitor (Connected between AEC+ and AEC-)	1.0 μ F
Operating Free Air Temperature (T_A)	-40°C to +85°C

DC Electrical Characteristics

Over Supply Voltage and Operating Temperature ranges, unless otherwise specified (*Note 2, Note 3*).

Symbol	Parameter	Conditions	Reference	Min	Typ	Max	Units
V_{CMIN}	Input Common Mode Voltage		SDI, \overline{SDI}		1.9		V
V_{SDI}	Input Voltage Swing	At LMH0024 input, (<i>Note 4, Note 6</i>)		720	800	950	mV _{P-P}
V_{CMOUT}	Output Common Mode Voltage		SDO, \overline{SDO}		$V_{CC} - V_{SDO}/2$		V
V_{SDO}	Output Voltage Swing	50 Ω load, differential			750		mV _{P-P}
	CLI DC Voltage	0m cable, (<i>Note 7</i>)	CLI		2.5		V
		Max cable, (<i>Note 7</i>)			2.0		V
	MUTE Input Voltage	Min to mute outputs	MUTE	3.0			V
		Max to force outputs active				2.0	V
I_{CC}	Supply Current	(<i>Note 8</i>)			60	77	mA

AC Electrical Characteristics

Over Supply Voltage and Operating Temperature ranges, unless otherwise specified ([Note 3](#)).

Symbol	Parameter	Conditions	Reference	Min	Typ	Max	Units
BR_{MIN}	Minimum Input Data Rate		SDI, \overline{SDI}		125		Mbps
BR_{MAX}	Maximum Input Data Rate					540	Mbps
	Maximum Equalized Cable Length (with equalizer pathological)	270 Mbps, Belden 1694A, 0.2UI output jitter, (Note 4)			350		m
		270 Mbps, Belden 8281, 0.2UI output jitter, (Note 4)			280		m
		540 Mbps, Belden 1694A, 0.2UI output jitter, (Note 4)			250		m
		540 Mbps, Belden 8281, 0.2UI output jitter, (Note 4)			180		m
t_r, t_f	Output Rise Time, Fall Time	20% – 80%, (Note 4)	SDO, \overline{SDO}		100	220	ps
	Mismatch in Rise/Fall Time	(Note 4)			2	15	ps
t_{OS}	Output Overshoot	(Note 4)			1	5	%
R_{OUT}	Output Resistance	single-ended, (Note 5)			50		Ω
RL_{IN}	Input Return Loss	(Note 9)	SDI, \overline{SDI}	15	18-20		dB
R_{IN}	Input Resistance	single-ended			1.3		k Ω
C_{IN}	Input Capacitance	single-ended, (Note 5)			1		pF

Note 1: "Absolute Maximum Ratings" are those parameter values beyond which the life and operation of the device cannot be guaranteed. The stating herein of these maximums shall not be construed to imply that the device can or should be operated at or beyond these values. The table of "Electrical Characteristics" specifies acceptable device operating conditions.

Note 2: Current flow into device pins is defined as positive. Current flow out of device pins is defined as negative. All voltages are stated referenced to $V_{EE} = 0$ Volts.

Note 3: Typical values are stated for $V_{CC} = +3.3V$ and $T_A = +25^\circ C$.

Note 4: Specification is guaranteed by characterization.

Note 5: Specification is guaranteed by design.

Note 6: The maximum input voltage swing assumes a nonstressing, DC-balance signal; specifically, the SMPTE-recommended color bar test signal. Pathological or other stressing signals may not be used. This specification is for 0m cable only.

Note 7: Input signal must be present for valid CLI. Refer to [Figure 1](#) for typical results.

Note 8: Supply current depends on the amount of cable being equalized. The current is highest for short cable and decreases as the cable length is increased. Refer to [Figure 2](#).

Note 9: Input return loss is dependent on board design. The LMH0024 meets this specification on the SD024 evaluation board from 5MHz to 1.5GHz.

Connection Diagram

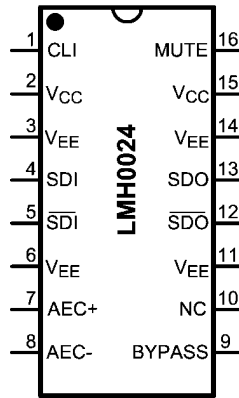

20172503
16-Pin SOIC
Order Number LMH0024MA
See NS Package Number M16A

Pin Descriptions

Pin #	Name	Description
1	CLI	Cable length indicator. Provides a voltage inversely proportional to the cable length being equalized.
2	V _{CC}	Positive power supply (+3.3V).
3	V _{EE}	Negative power supply (ground).
4	SDI	Serial data true input.
5	$\overline{\text{SDI}}$	Serial data complement input.
6	V _{EE}	Negative power supply (ground).
7	AEC+	AEC loop filter external capacitor (1 μ F) positive connection.
8	AEC-	AEC loop filter external capacitor (1 μ F) negative connection.
9	BYPASS	Bypasses equalization and DC restoration when high. No equalization occurs in this mode.
10	NC	No connect.
11	V _{EE}	Negative power supply (ground).
12	$\overline{\text{SDO}}$	Serial data complement output.
13	SDO	Serial data true output.
14	V _{EE}	Negative power supply (ground).
15	V _{CC}	Positive power supply (+3.3V).
16	MUTE	Output mute. To force SDO and $\overline{\text{SDO}}$ to mute, tie to V _{CC} . To disable MUTE, tie to GND. Typical application is MUTE tied to GND to enable the outputs. MUTE must be tied either high or low; it may not be left unconnected.

Block Diagram

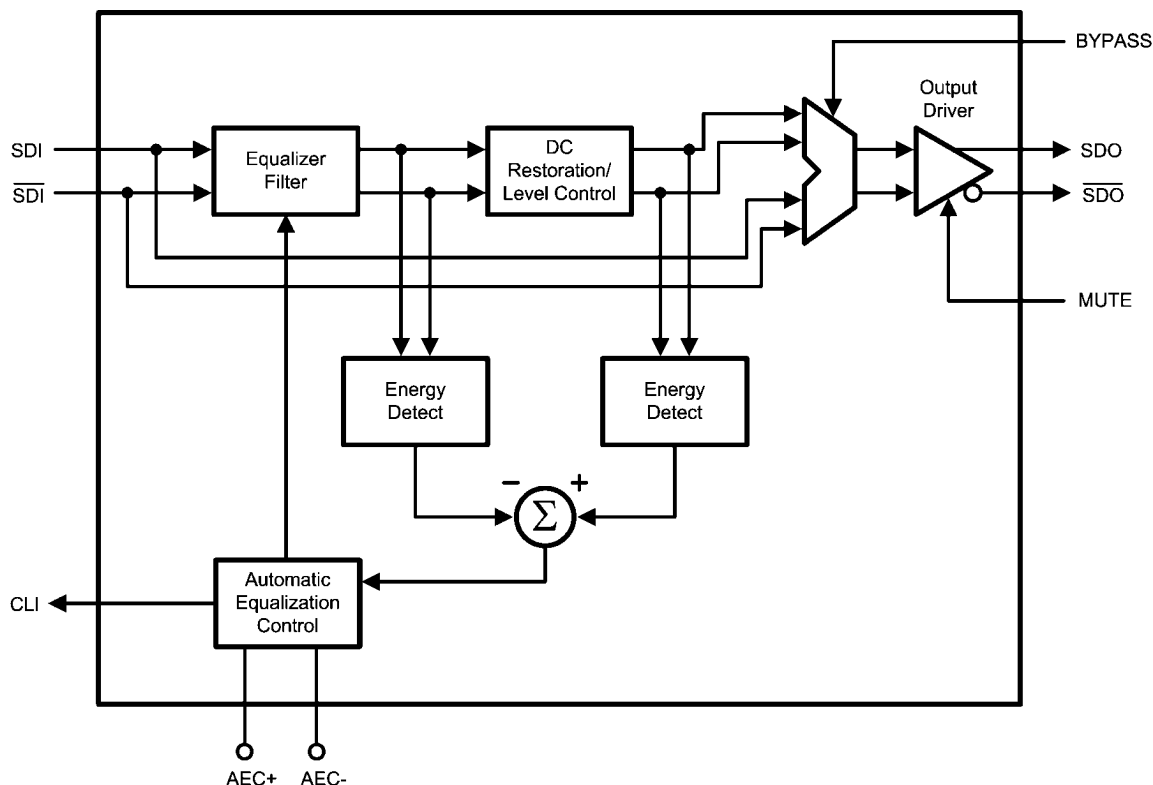

20172502

Device Operation

BLOCK DESCRIPTION

The **Equalizer Filter** block is a multi-stage adaptive filter. If Bypass is high, the equalizer filter is disabled.

The **DC Restoration / Level Control** block receives the differential signals from the equalizer filter block. This block incorporates a self-biasing DC restoration circuit to fully DC restore the signals. If Bypass is high, this function is disabled.

The signals before and after the DC Restoration / Level Control block are used to generate the **Automatic Equalization Control (AEC)** signal. This control signal sets the gain and bandwidth of the equalizer filter. The loop response in the AEC block is controlled by an external $1\mu\text{F}$ capacitor placed across the AEC+ and AEC- pins. **Cable Length Indicator (CLI)** is derived from this block.

The **Output Driver** produces SDO and $\overline{\text{SDO}}$. SDO and $\overline{\text{SDO}}$ may be forced to mute by activating **MUTE**.

CABLE LENGTH INDICATOR (CLI)

The cable length indicator provides a voltage to indicate the length of cable being equalized. The CLI voltage decreases as the cable length increases. *Figure 1* shows the typical CLI voltage vs. Belden 1694A cable length. Note: CLI is only valid when an input signal is present.

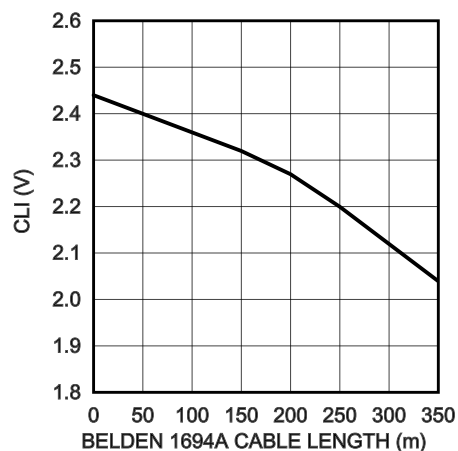

20172504

FIGURE 1. CLI vs. Belden 1694A Cable Length

MUTE

MUTE can be used to manually mute or enable the LMH0024 outputs. MUTE must be tied to a low-level input or ground for SDO and $\overline{\text{SDO}}$ to be active. Applying a high input to MUTE will mute the LMH0024 outputs.

INPUT INTERFACING

The LMH0024 accepts either differential or single-ended input. The input must be AC coupled. Transformer coupling is not supported.

The LMH0024 correctly handles equalizer pathological signals for standard definition serial digital video, as described in SMPTE RP 178.

OUTPUT INTERFACING

The SDO and $\overline{\text{SDO}}$ outputs are internally loaded with 50Ω . They produce a $750\text{ mV}_{\text{P-P}}$ differential output, or a $375\text{ mV}_{\text{P-P}}$ single-ended output.

Application Information

PCB LAYOUT RECOMMENDATIONS

Please refer to the following Application Note for the CLC034 on National's website: **AN-1372, "LMH0034 PCB Layout Techniques."** The PCB layout techniques in this application note apply to the LMH0024 as well.

REPLACING THE GENNUM GS9064

The LMH0024 is footprint compatible with the Gennum GS9064. Pin 16 (MUTE) of the LMH0024 must be connect to ground for correct operation.

SUPPLY CURRENT VS. CABLE LENGTH

The supply current (I_{CC}) depends on the amount of cable being equalized. The current is highest for short cable and decreases as the cable length is increased. *Figure 2* shows

supply current vs. Belden 1694A cable length for 270 Mbps data.

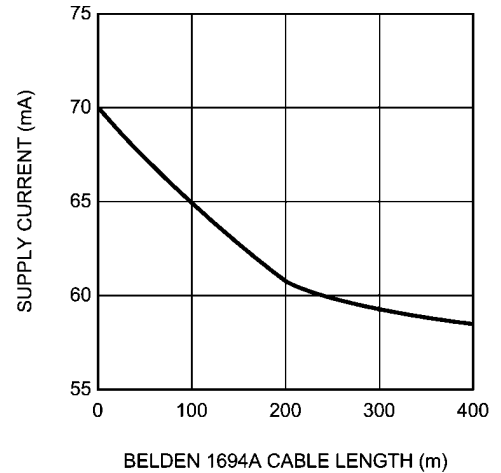

20172515

FIGURE 2. Supply Current vs. Belden 1694A Cable Length, 270 Mbps

Physical Dimensions inches (millimeters) unless otherwise noted

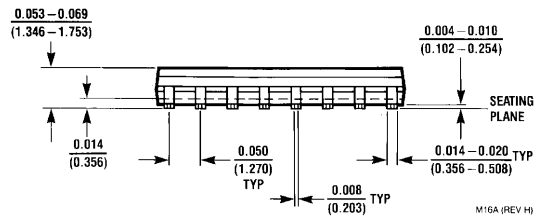
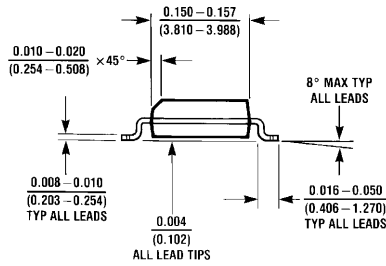
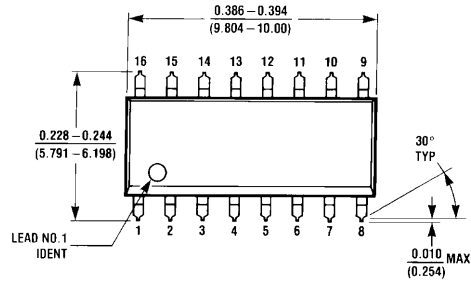

M16A (REV H)

16-Pin SOIC
Order Number LMH0024MA
NS Package Number M16A

Notes

For more National Semiconductor product information and proven design tools, visit the following Web sites at:
www.national.com

Products		Design Support	
Amplifiers	www.national.com/amplifiers	WEBENCH® Tools	www.national.com/webench
Audio	www.national.com/audio	App Notes	www.national.com/appnotes
Clock and Timing	www.national.com/timing	Reference Designs	www.national.com/refdesigns
Data Converters	www.national.com/adc	Samples	www.national.com/samples
Interface	www.national.com/interface	Eval Boards	www.national.com/evalboards
LVDS	www.national.com/lvds	Packaging	www.national.com/packaging
Power Management	www.national.com/power	Green Compliance	www.national.com/quality/green
Switching Regulators	www.national.com/switchers	Distributors	www.national.com/contacts
LDOs	www.national.com/ldo	Quality and Reliability	www.national.com/quality
LED Lighting	www.national.com/led	Feedback/Support	www.national.com/feedback
Voltage References	www.national.com/vref	Design Made Easy	www.national.com/easy
PowerWise® Solutions	www.national.com/powerwise	Applications & Markets	www.national.com/solutions
Serial Digital Interface (SDI)	www.national.com/sdi	Mil/Aero	www.national.com/milaero
Temperature Sensors	www.national.com/tempensors	SolarMagic™	www.national.com/solarmagic
PLL/VCO	www.national.com/wireless	PowerWise® Design University	www.national.com/training

THE CONTENTS OF THIS DOCUMENT ARE PROVIDED IN CONNECTION WITH NATIONAL SEMICONDUCTOR CORPORATION ("NATIONAL") PRODUCTS. NATIONAL MAKES NO REPRESENTATIONS OR WARRANTIES WITH RESPECT TO THE ACCURACY OR COMPLETENESS OF THE CONTENTS OF THIS PUBLICATION AND RESERVES THE RIGHT TO MAKE CHANGES TO SPECIFICATIONS AND PRODUCT DESCRIPTIONS AT ANY TIME WITHOUT NOTICE. NO LICENSE, WHETHER EXPRESS, IMPLIED, ARISING BY ESTOPPEL OR OTHERWISE, TO ANY INTELLECTUAL PROPERTY RIGHTS IS GRANTED BY THIS DOCUMENT.

TESTING AND OTHER QUALITY CONTROLS ARE USED TO THE EXTENT NATIONAL DEEMS NECESSARY TO SUPPORT NATIONAL'S PRODUCT WARRANTY. EXCEPT WHERE MANDATED BY GOVERNMENT REQUIREMENTS, TESTING OF ALL PARAMETERS OF EACH PRODUCT IS NOT NECESSARILY PERFORMED. NATIONAL ASSUMES NO LIABILITY FOR APPLICATIONS ASSISTANCE OR BUYER PRODUCT DESIGN. BUYERS ARE RESPONSIBLE FOR THEIR PRODUCTS AND APPLICATIONS USING NATIONAL COMPONENTS. PRIOR TO USING OR DISTRIBUTING ANY PRODUCTS THAT INCLUDE NATIONAL COMPONENTS, BUYERS SHOULD PROVIDE ADEQUATE DESIGN, TESTING AND OPERATING SAFEGUARDS.

EXCEPT AS PROVIDED IN NATIONAL'S TERMS AND CONDITIONS OF SALE FOR SUCH PRODUCTS, NATIONAL ASSUMES NO LIABILITY WHATSOEVER, AND NATIONAL DISCLAIMS ANY EXPRESS OR IMPLIED WARRANTY RELATING TO THE SALE AND/OR USE OF NATIONAL PRODUCTS INCLUDING LIABILITY OR WARRANTIES RELATING TO FITNESS FOR A PARTICULAR PURPOSE, MERCHANTABILITY, OR INFRINGEMENT OF ANY PATENT, COPYRIGHT OR OTHER INTELLECTUAL PROPERTY RIGHT.

LIFE SUPPORT POLICY

NATIONAL'S PRODUCTS ARE NOT AUTHORIZED FOR USE AS CRITICAL COMPONENTS IN LIFE SUPPORT DEVICES OR SYSTEMS WITHOUT THE EXPRESS PRIOR WRITTEN APPROVAL OF THE CHIEF EXECUTIVE OFFICER AND GENERAL COUNSEL OF NATIONAL SEMICONDUCTOR CORPORATION. As used herein:

Life support devices or systems are devices which (a) are intended for surgical implant into the body, or (b) support or sustain life and whose failure to perform when properly used in accordance with instructions for use provided in the labeling can be reasonably expected to result in a significant injury to the user. A critical component is any component in a life support device or system whose failure to perform can be reasonably expected to cause the failure of the life support device or system or to affect its safety or effectiveness.

National Semiconductor and the National Semiconductor logo are registered trademarks of National Semiconductor Corporation. All other brand or product names may be trademarks or registered trademarks of their respective holders.

Copyright© 2011 National Semiconductor Corporation

For the most current product information visit us at www.national.com



National Semiconductor Americas Technical Support Center
 Email: support@nsc.com
 Tel: 1-800-272-9959

National Semiconductor Europe Technical Support Center
 Email: europe.support@nsc.com

National Semiconductor Asia Pacific Technical Support Center
 Email: ap.support@nsc.com

National Semiconductor Japan Technical Support Center
 Email: jpn.feedback@nsc.com

IMPORTANT NOTICE

Texas Instruments Incorporated and its subsidiaries (TI) reserve the right to make corrections, modifications, enhancements, improvements, and other changes to its products and services at any time and to discontinue any product or service without notice. Customers should obtain the latest relevant information before placing orders and should verify that such information is current and complete. All products are sold subject to TI's terms and conditions of sale supplied at the time of order acknowledgment.

TI warrants performance of its hardware products to the specifications applicable at the time of sale in accordance with TI's standard warranty. Testing and other quality control techniques are used to the extent TI deems necessary to support this warranty. Except where mandated by government requirements, testing of all parameters of each product is not necessarily performed.

TI assumes no liability for applications assistance or customer product design. Customers are responsible for their products and applications using TI components. To minimize the risks associated with customer products and applications, customers should provide adequate design and operating safeguards.

TI does not warrant or represent that any license, either express or implied, is granted under any TI patent right, copyright, mask work right, or other TI intellectual property right relating to any combination, machine, or process in which TI products or services are used. Information published by TI regarding third-party products or services does not constitute a license from TI to use such products or services or a warranty or endorsement thereof. Use of such information may require a license from a third party under the patents or other intellectual property of the third party, or a license from TI under the patents or other intellectual property of TI.

Reproduction of TI information in TI data books or data sheets is permissible only if reproduction is without alteration and is accompanied by all associated warranties, conditions, limitations, and notices. Reproduction of this information with alteration is an unfair and deceptive business practice. TI is not responsible or liable for such altered documentation. Information of third parties may be subject to additional restrictions.

Resale of TI products or services with statements different from or beyond the parameters stated by TI for that product or service voids all express and any implied warranties for the associated TI product or service and is an unfair and deceptive business practice. TI is not responsible or liable for any such statements.

TI products are not authorized for use in safety-critical applications (such as life support) where a failure of the TI product would reasonably be expected to cause severe personal injury or death, unless officers of the parties have executed an agreement specifically governing such use. Buyers represent that they have all necessary expertise in the safety and regulatory ramifications of their applications, and acknowledge and agree that they are solely responsible for all legal, regulatory and safety-related requirements concerning their products and any use of TI products in such safety-critical applications, notwithstanding any applications-related information or support that may be provided by TI. Further, Buyers must fully indemnify TI and its representatives against any damages arising out of the use of TI products in such safety-critical applications.

TI products are neither designed nor intended for use in military/aerospace applications or environments unless the TI products are specifically designated by TI as military-grade or "enhanced plastic." Only products designated by TI as military-grade meet military specifications. Buyers acknowledge and agree that any such use of TI products which TI has not designated as military-grade is solely at the Buyer's risk, and that they are solely responsible for compliance with all legal and regulatory requirements in connection with such use.

TI products are neither designed nor intended for use in automotive applications or environments unless the specific TI products are designated by TI as compliant with ISO/TS 16949 requirements. Buyers acknowledge and agree that, if they use any non-designated products in automotive applications, TI will not be responsible for any failure to meet such requirements.

Following are URLs where you can obtain information on other Texas Instruments products and application solutions:

Products

Audio	www.ti.com/audio
Amplifiers	amplifier.ti.com
Data Converters	dataconverter.ti.com
DLP® Products	www.dlp.com
DSP	dsp.ti.com
Clocks and Timers	www.ti.com/clocks
Interface	interface.ti.com
Logic	logic.ti.com
Power Mgmt	power.ti.com
Microcontrollers	microcontroller.ti.com
RFID	www.ti-rfid.com
OMAP Mobile Processors	www.ti.com/omap
Wireless Connectivity	www.ti.com/wirelessconnectivity

Applications

Communications and Telecom	www.ti.com/communications
Computers and Peripherals	www.ti.com/computers
Consumer Electronics	www.ti.com/consumer-apps
Energy and Lighting	www.ti.com/energy
Industrial	www.ti.com/industrial
Medical	www.ti.com/medical
Security	www.ti.com/security
Space, Avionics and Defense	www.ti.com/space-avionics-defense
Transportation and Automotive	www.ti.com/automotive
Video and Imaging	www.ti.com/video

TI E2E Community Home Page

e2e.ti.com

Mailing Address: Texas Instruments, Post Office Box 655303, Dallas, Texas 75265
Copyright © 2011, Texas Instruments Incorporated







Looking for pricing, stock, or lifecycle information?

Click below to explore more details on WIN SOURCE:

 [View LMH0024MA/NOPB on WIN SOURCE](#)

 [Texas Instruments](#) Information

Optimize Your Supply Chain with WIN SOURCE Solutions

-  Global Sourcing Solution
-  Obsolete Management
-  Cost Control Management
-  Shortage Management
-  Alternative Solution
-  Excess Inventory Management