



**THE DATASHEET OF
TPA0233DGQ**



TPA0233 2-W MONO AUDIO POWER AMPLIFIER WITH HEADPHONE DRIVE

SLOS278D – JANUARY 2000 – REVISED NOVEMBER 2002

- Ideal for Notebook Computers, PDAs, and Other Small Portable Audio Devices
- 2 W Into 4 Ω From 5-V Supply
- 0.6 W Into 4 Ω From 3-V Supply
- Stereo Head Phone Drive
- Mono (BTL) Signal Created by Summing Left and Right Signals
- Wide Power Supply Compatibility
3 V to 5 V
- Meets PC99 Portable Specs (target)
- Low Supply Current
 - 4 mA Typical at 5 V
 - 3.3 mA Typical at 3 V
- Shutdown Control . . . 1 μ A Typical
- Shutdown Pin is TTL Compatible
- -40°C to 85°C Operating Temperature Range
- Space-Saving, Thermally-Enhanced MSOP Packaging

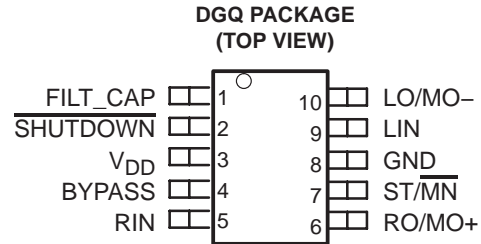

description

The TPA0233 is a 2-W mono bridge-tied-load (BTL) amplifier designed to drive speakers with as low as 4- Ω impedance. The mono signal is created by summing left and right inputs. The amplifier can be reconfigured on the fly to drive two stereo single-ended (SE) signals into head phones. This makes the device ideal for use in small notebook computers, PDAs, digital personal audio players, anyplace a mono speaker and stereo headphones are required. From a 5-V supply, the TPA0233 deliver 2 W of power into a 4- Ω speaker.

The gain of the input stage is set by the user-selected input resistor and a 50-k Ω internal feedback resistor ($A_V = -R_F / R_I$). The power stage is internally configured with a gain of -1.25 V/V in SE mode, and -2.5 V/V in BTL mode. Thus, the overall gain of the amplifier is 62.5 k Ω / R_I in SE mode and 125 k Ω / R_I in BTL mode. The input terminals are high-impedance CMOS inputs, and can be used as summing nodes.

The TPA0233 is available in the 10-pin thermally-enhanced MSOP package (DGQ) and operates over an ambient temperature range of -40°C to 85°C .



Please be aware that an important notice concerning availability, standard warranty, and use in critical applications of Texas Instruments semiconductor products and disclaimers thereto appears at the end of this data sheet.

PRODUCTION DATA information is current as of publication date. Products conform to specifications per the terms of Texas Instruments standard warranty. Production processing does not necessarily include testing of all parameters.

 **TEXAS
INSTRUMENTS**

POST OFFICE BOX 655303 • DALLAS, TEXAS 75265

Copyright © 2002, Texas Instruments Incorporated

TPA0233 2-W MONO AUDIO POWER AMPLIFIER WITH HEADPHONE DRIVE

SLOS278D – JANUARY 2000 – REVISED NOVEMBER 2002

functional block diagram

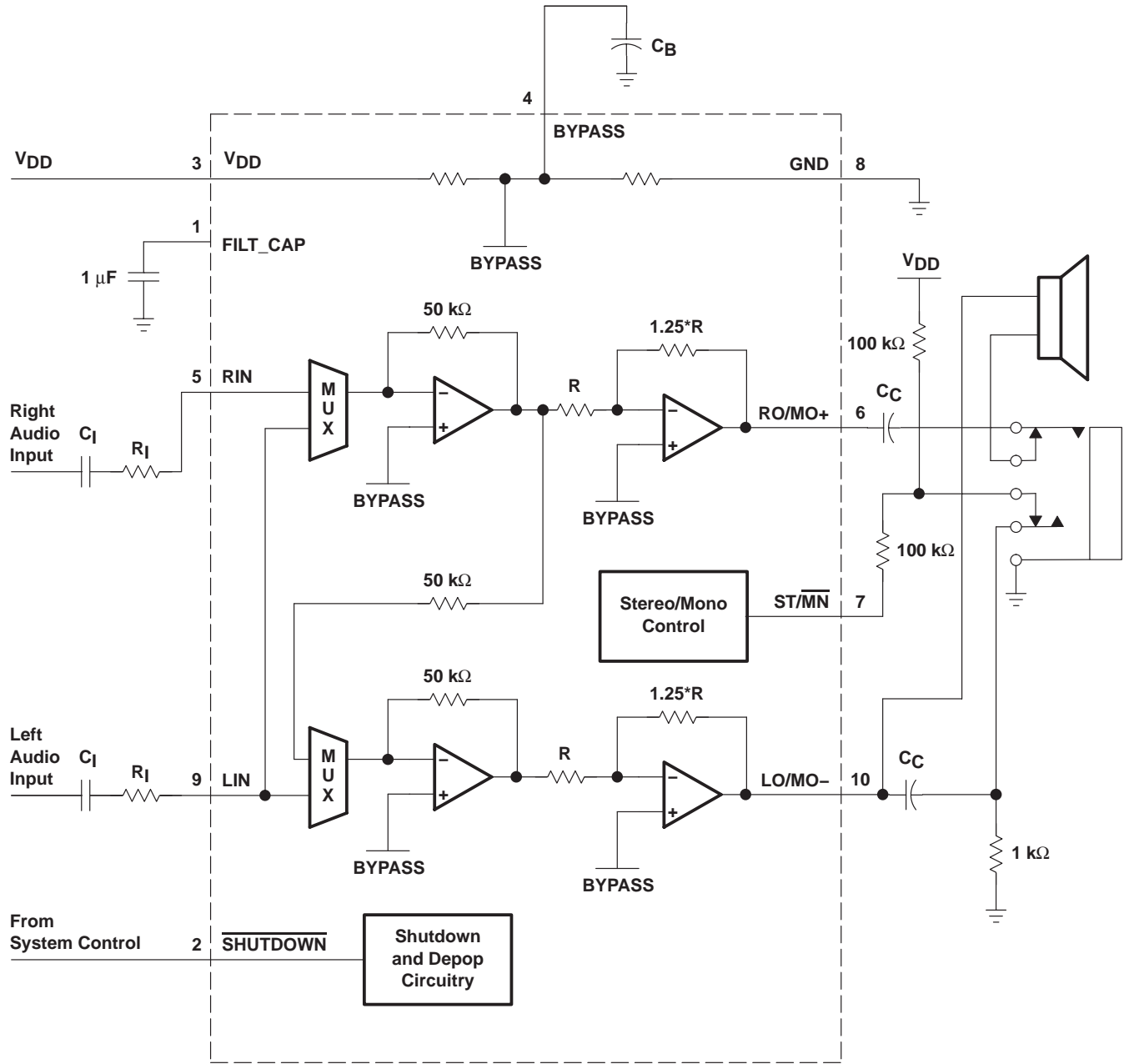

AVAILABLE OPTIONS

T _A	PACKAGED DEVICES	
	MSOPT† (DGQ)	MSOP SYMBOLIZATION
-40°C to 85°C	TPA0233DGQ	AEJ

† The DGQ package are available taped and reeled. To order a taped and reeled part, add the suffix R to the part number (e.g., TPA0233DGQR).

Terminal Functions

TERMINAL NAME	NO.	I/O	DESCRIPTION
BYPASS	4	I	BYPASS is the tap to the voltage divider for internal mid-supply bias. This terminal should be connected to a 0.1- μ F to 1- μ F capacitor.
FILT_CAP	1	I	Terminal is used to filter supply.
GND	8		Ground terminal
LIN	9	I	Left-channel input terminal
LO/MO-	10	O	Left-output in SE mode and mono negative output in BTL mode.
RIN	5	I	Right-channel input terminal
RO/MO+	6	O	Right-output in SE mode and mono positive output in BTL mode
SHUTDOWN	2	I	SHUTDOWN places the entire device in shutdown mode when held low. TTL compatible input.
ST/MN	7	I	Selects between stereo and mono mode. When held high, the amplifier is in SE stereo mode, while held low, the amplifier is in BTL mono mode.
V _{DD}	3	I	V _{DD} is the supply voltage terminal.

absolute maximum ratings over operating free-air temperature range (unless otherwise noted)[†]

Supply voltage, V _{DD}	6 V
Input voltage range, V _I	-0.3 V to V _{DD} +0.3 V
Continuous total power dissipation	internally limited (see Dissipation Rating Table)
Operating free-air temperature range, T _A (see Table 3)	-40°C to 85°C
Operating junction temperature range, T _J	-40°C to 150°C
Storage temperature range, T _{stg}	-65°C to 150°C
Lead temperature 1,6 mm (1/16 inch) from case for 10 seconds	260°C

[†] Stresses beyond those listed under “absolute maximum ratings” may cause permanent damage to the device. These are stress ratings only, and functional operation of the device at these or any other conditions beyond those indicated under “recommended operating conditions” is not implied. Exposure to absolute-maximum-rated conditions for extended periods may affect device reliability.

DISSIPATION RATING TABLE

PACKAGE	T _A ≤ 25°C	DERATING FACTOR	T _A = 70°C	T _A = 85°C
DGQ	2.14 W [‡]	17.1 mW/°C	1.37 W	1.11 W

[‡] See the Texas Instruments document, *PowerPAD Thermally Enhanced Package Application Report* (SLMA002), for more information on the PowerPAD™ package. The thermal data was measured on a PCB layout based on the information in the section entitled *Texas Instruments Recommended Board for PowerPAD* on page 33 of that document.

recommended operating conditions

			MIN	MAX	UNIT
Supply voltage, V _{DD}			2.5	5.5	V
High-level input voltage, V _{IH}	ST/MN	V _{DD} = 3 V	2.7		V
		V _{DD} = 5 V	4.5		
Low-level input voltage, V _{IL}	SHUTDOWN		2		V
	ST/MN	V _{DD} = 3 V		1.65	
		V _{DD} = 5 V		2.75	
	SHUTDOWN			0.8	
Operating free-air temperature, T _A			-40	85	°C

PowerPAD is a trademark of Texas Instruments.



TPA0233

2-W MONO AUDIO POWER AMPLIFIER WITH HEADPHONE DRIVE

SLOS278D – JANUARY 2000 – REVISED NOVEMBER 2002

electrical characteristics at specified free-air temperature, $V_{DD} = 3\text{ V}$, $T_A = 25^\circ\text{C}$ (unless otherwise noted)

PARAMETER	TEST CONDITIONS	MIN	TYP	MAX	UNIT
$ V_{OO} $ Output offset voltage (measured differentially)	$\overline{\text{SHUTDOWN}} = 2\text{ V}$, $\overline{\text{ST/MN}} = 0$, $R_L = 4\ \Omega$			30	mV
I_{DD} Supply current	$V_{DD} = 2.5\text{ V}$, $\overline{\text{SHUTDOWN}} = 2\text{ V}$		3.3	5	mA
$I_{DD}(\text{SD})$ Supply current, shutdown mode	$\overline{\text{SHUTDOWN}} = 0\text{ V}$		1	10	μA
$ I_{IH} $ High-level input current	$\overline{\text{SHUTDOWN}}$, $V_{DD} = 3.3\text{ V}$, $V_I = 3.3\text{ V}$			1	μA
	$\overline{\text{ST/MN}}$, $V_{DD} = 3.3\text{ V}$, $V_I = 3.3\text{ V}$			1	
$ I_{IL} $ Low-level input current	$\overline{\text{SHUTDOWN}}$, $V_{DD} = 3.3\text{ V}$, $V_I = 0\text{ V}$			1	μA
	$\overline{\text{ST/MN}}$, $V_{DD} = 3.3\text{ V}$, $V_I = 0\text{ V}$			1	
R_F Feedback resistor	$V_{DD} = 2.5\text{ V}$, $R_L = 4\ \Omega$, $\overline{\text{SHUTDOWN}} = 2\text{ V}$, $\overline{\text{ST/MN}} = 1.375\text{ V}$	47	50	57	k Ω

operating characteristics, $V_{DD} = 3\text{ V}$, $T_A = 25^\circ\text{C}$, $R_L = 4\ \Omega$

PARAMETER	TEST CONDITIONS	MIN	TYP	MAX	UNIT
P_O Output power, See Note 1	THD = 1%, BTL mode		660		mW
	THD = 0.1%, SE mode, $R_L = 32\ \Omega$		33		
THD + N Total harmonic distortion plus noise	$P_O = 500\text{ mW}$, $f = 20\text{ Hz to } 20\text{ kHz}$		0.3%		
B_{OM} Maximum output power bandwidth	Gain = 2, THD = 2%		20		kHz

NOTE 1: Output power is measured at the output terminals of the device at $f = 1\text{ kHz}$.

electrical characteristics at specified free-air temperature, $V_{DD} = 5\text{ V}$, $T_A = 25^\circ\text{C}$ (unless otherwise noted)

PARAMETER	TEST CONDITIONS	MIN	TYP	MAX	UNIT
$ V_{OO} $ Output offset voltage (measured differentially)	$\overline{\text{SHUTDOWN}} = 2\text{ V}$, $\overline{\text{ST/MN}} = 0$, $R_L = 4\ \Omega$			30	mV
I_{DD} Supply current	$\overline{\text{SHUTDOWN}} = 2\text{ V}$		4	7	mA
$I_{DD}(\text{SD})$ Supply current, shutdown mode	$\overline{\text{SHUTDOWN}} = 0\text{ V}$		1	10	μA
$ I_{IH} $ High-level input current	$\overline{\text{SHUTDOWN}}$, $V_{DD} = 5.5\text{ V}$, $V_I = 5.5\text{ V}$			1	μA
	$\overline{\text{ST/MN}}$, $V_{DD} = 5.5\text{ V}$, $V_I = 5.5\text{ V}$			1	
$ I_{IL} $ Low-level input current	$\overline{\text{SHUTDOWN}}$, $V_{DD} = 5.5\text{ V}$, $V_I = 0\text{ V}$			1	μA
	$\overline{\text{ST/MN}}$, $V_{DD} = 5.5\text{ V}$, $V_I = 0\text{ V}$			1	

operating characteristics, $V_{DD} = 5\text{ V}$, $T_A = 25^\circ\text{C}$, $R_L = 4\ \Omega$

PARAMETER	TEST CONDITIONS	MIN	TYP	MAX	UNIT
P_O Output power, see Note 1	THD = 1%, BTL mode		2		W
	THD = 0.1%, SE mode, $R_L = 32\ \Omega$		92		mW
THD + N Total harmonic distortion plus noise	$P_O = 1\text{ W}$, $f = 20\text{ Hz to } 20\text{ kHz}$		0.2%		
B_{OM} Maximum output power bandwidth	Gain = 2.5, THD = 2%		20		kHz

NOTE 1: Output power is measured at the output terminals of the device at $f = 1\text{ kHz}$.



TYPICAL CHARACTERISTICS

Table of Graphs

			FIGURE
	Supply ripple rejection ratio	vs Frequency	1, 2
I_{DD}	Supply current	vs Supply voltage	3
P_O	Output power	vs Supply voltage	4, 5
		vs Load resistance	6, 7
THD+N	Total harmonic distortion plus noise	vs Frequency	8, 9, 10, 11
		vs Output power	12, 13, 14, 15, 16, 17
V_n	Output noise voltage	vs Frequency	18, 19
	Closed loop response		20, 21
	Crosstalk	vs Frequency	22, 23

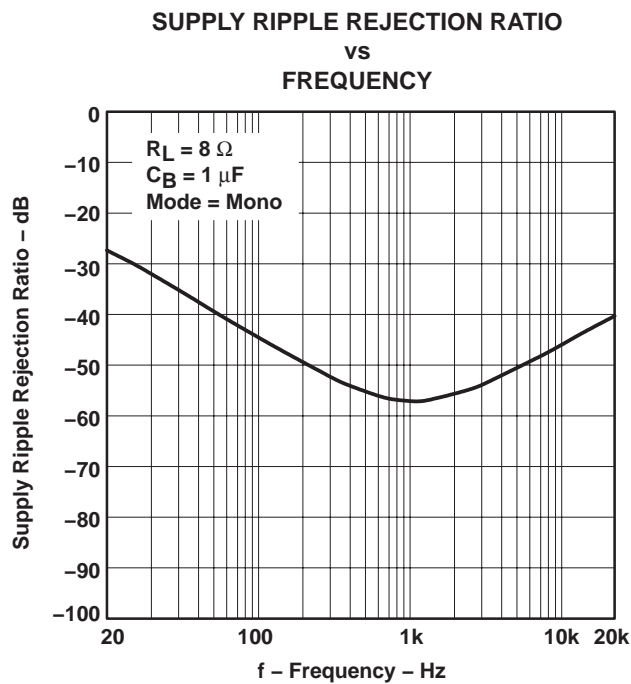

Figure 1

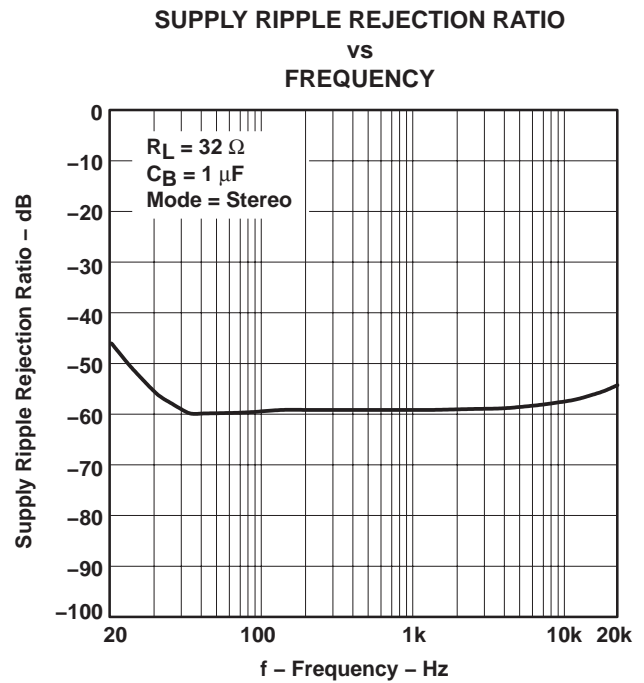

Figure 2

TPA0233
2-W MONO AUDIO POWER AMPLIFIER
WITH HEADPHONE DRIVE

SLOS278D – JANUARY 2000 – REVISED NOVEMBER 2002

TYPICAL CHARACTERISTICS

SUPPLY CURRENT
vs
SUPPLY VOLTAGE

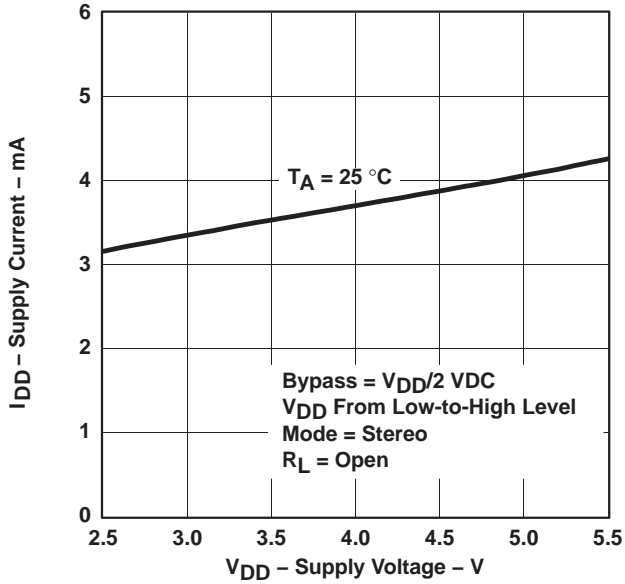

Figure 3

OUTPUT POWER
vs
SUPPLY VOLTAGE

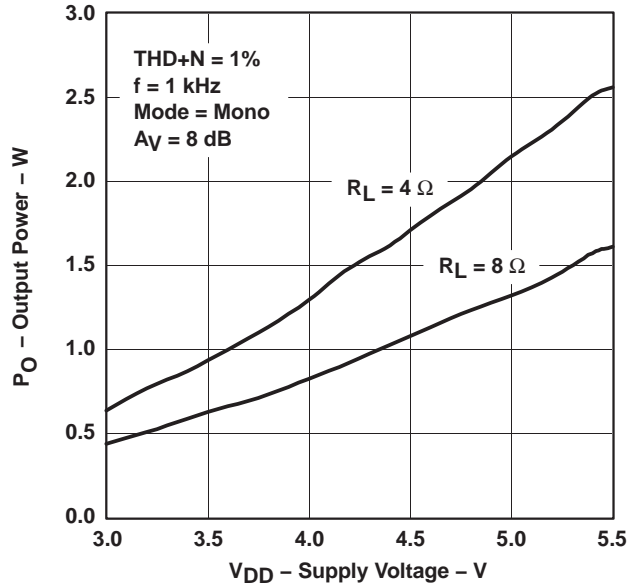

Figure 4

OUTPUT POWER
vs
SUPPLY VOLTAGE

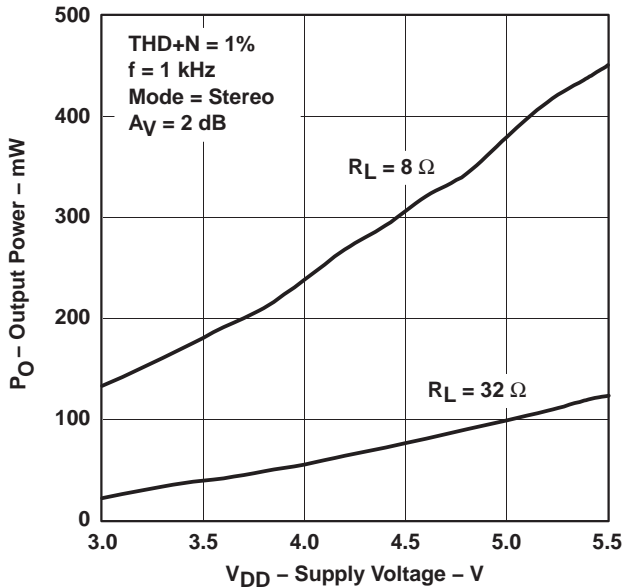

Figure 5

OUTPUT POWER
vs
LOAD RESISTANCE

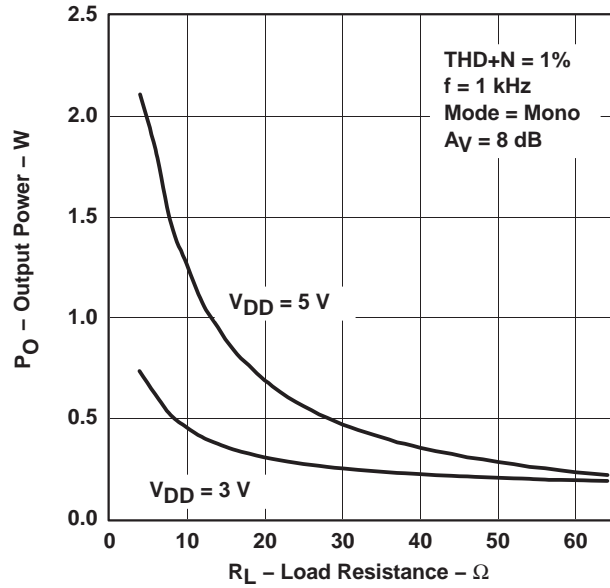

Figure 6



TYPICAL CHARACTERISTICS

**OUTPUT POWER
 vs
 LOAD RESISTANCE**

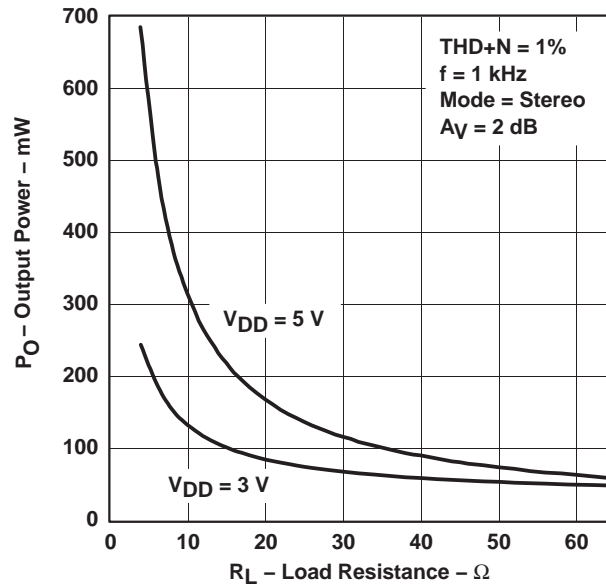

Figure 7

**TOTAL HARMONIC DISTORTION PLUS NOISE
 vs
 FREQUENCY**

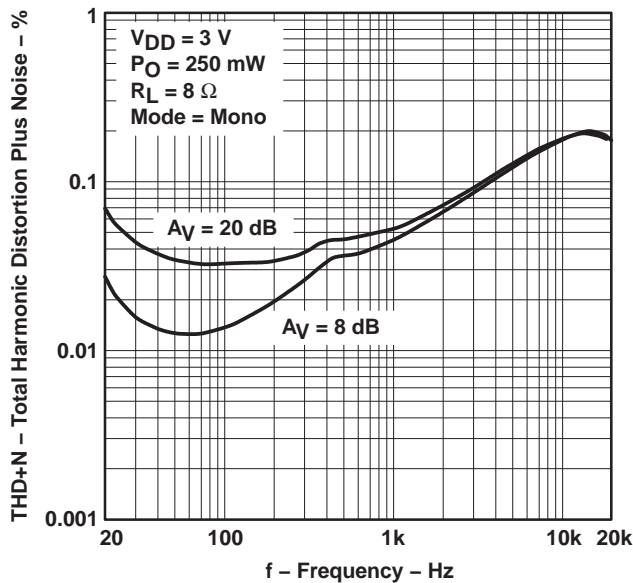

Figure 8

**TOTAL HARMONIC DISTORTION PLUS NOISE
 vs
 FREQUENCY**

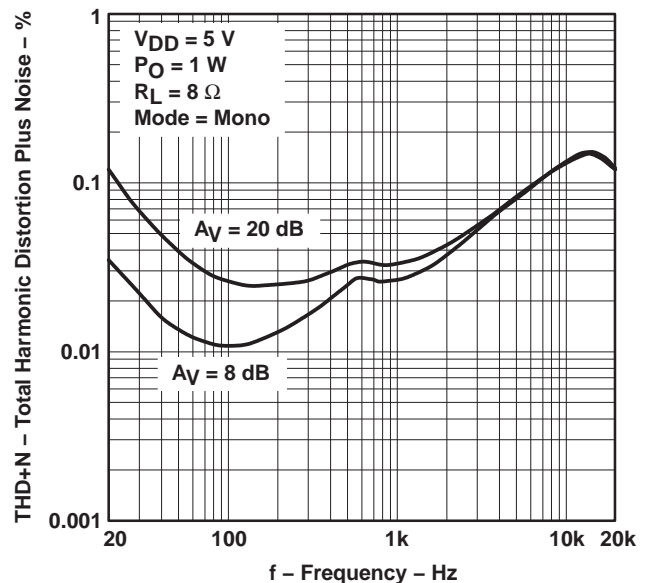

Figure 9

TPA0233
2-W MONO AUDIO POWER AMPLIFIER
WITH HEADPHONE DRIVE

SLOS278D – JANUARY 2000 – REVISED NOVEMBER 2002

TYPICAL CHARACTERISTICS

TOTAL HARMONIC DISTORTION PLUS NOISE
vs
FREQUENCY

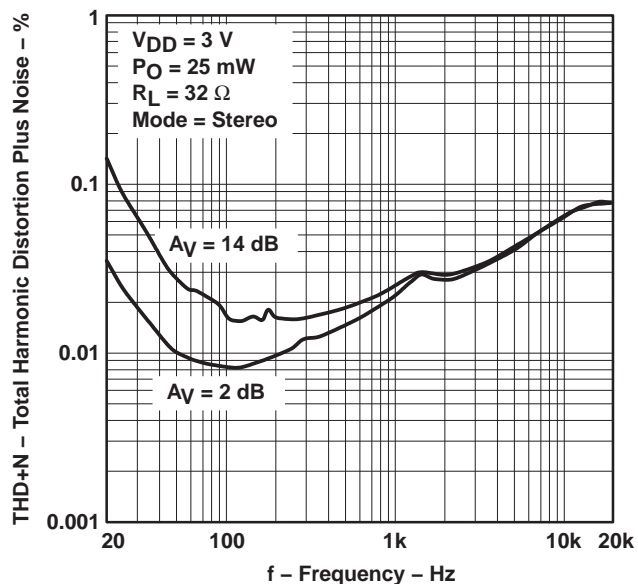

Figure 10

TOTAL HARMONIC DISTORTION PLUS NOISE
vs
FREQUENCY

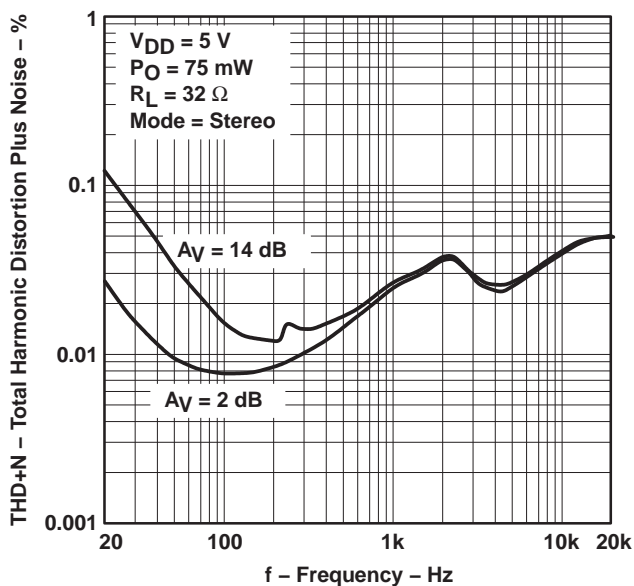

Figure 11

TOTAL HARMONIC DISTORTION PLUS NOISE
vs
OUTPUT POWER

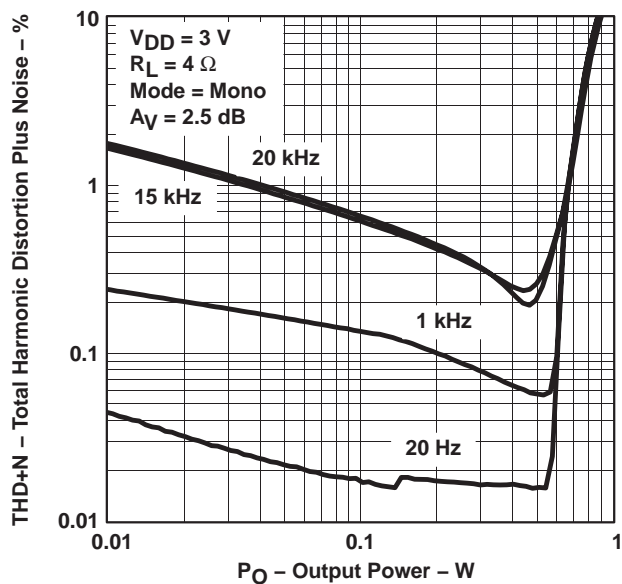

Figure 12

TOTAL HARMONIC DISTORTION PLUS NOISE
vs
OUTPUT POWER

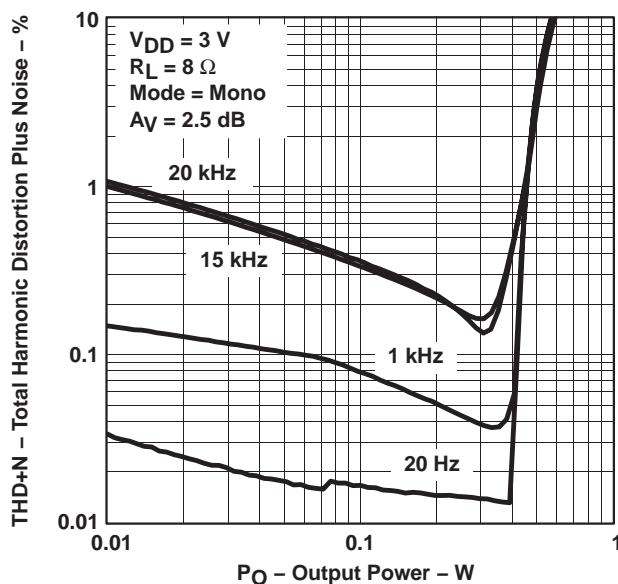

Figure 13



TYPICAL CHARACTERISTICS

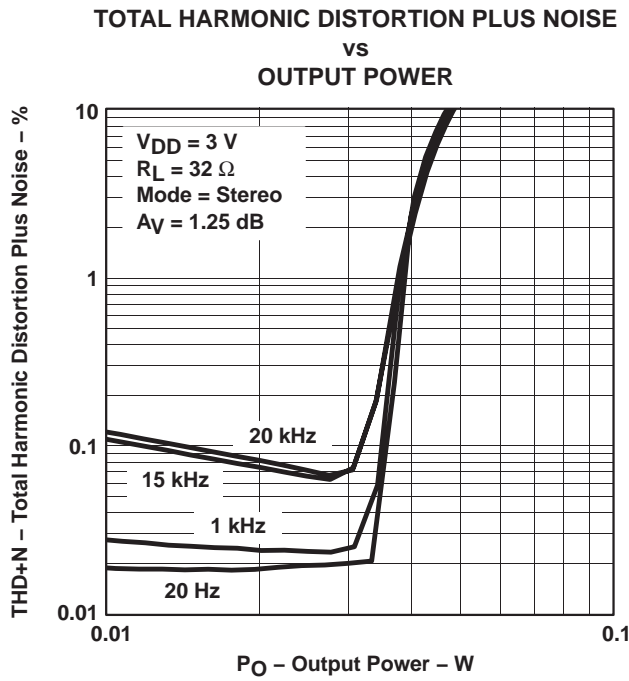

Figure 14

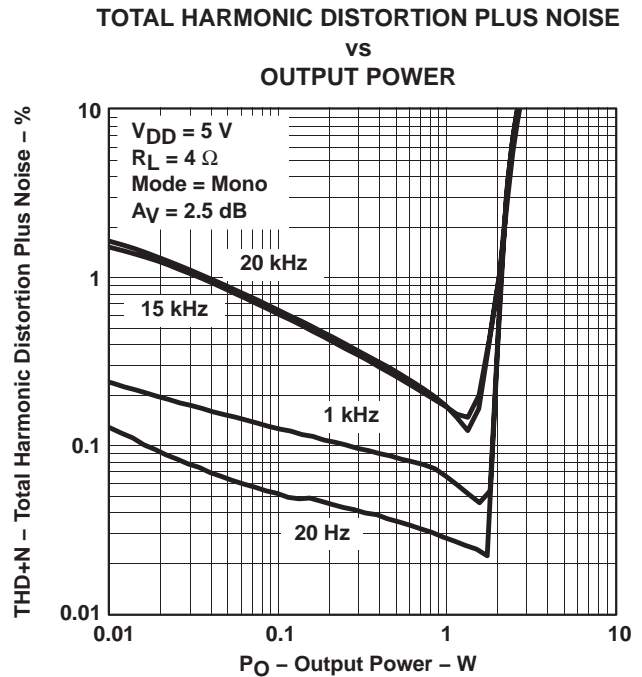

Figure 15

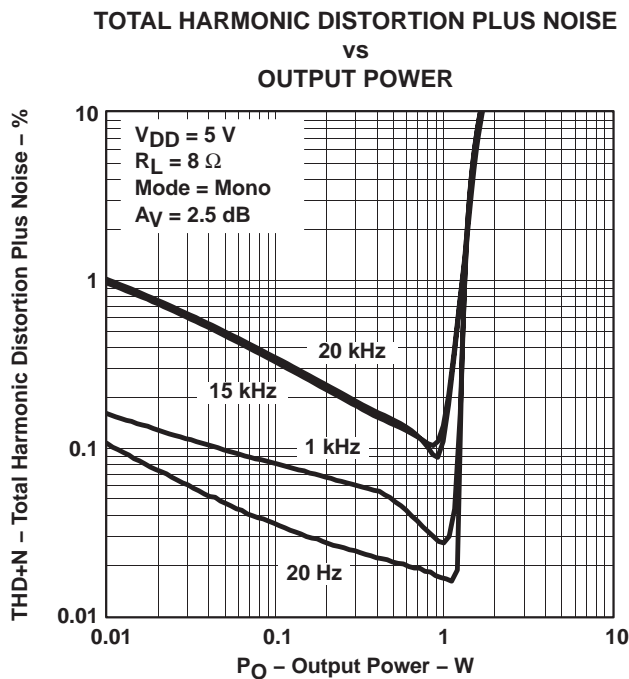

Figure 16

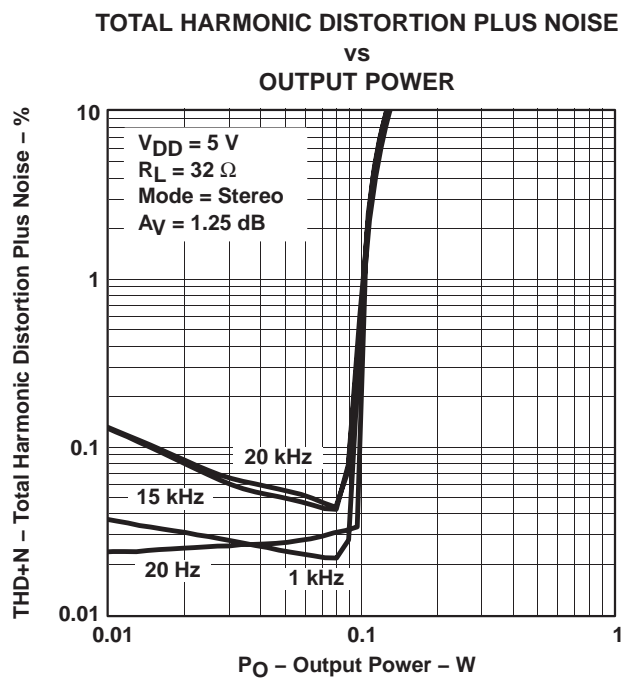

Figure 17

TPA0233
2-W MONO AUDIO POWER AMPLIFIER
WITH HEADPHONE DRIVE

SLOS278D – JANUARY 2000 – REVISED NOVEMBER 2002

TYPICAL CHARACTERISTICS

OUTPUT NOISE VOLTAGE
vs
FREQUENCY

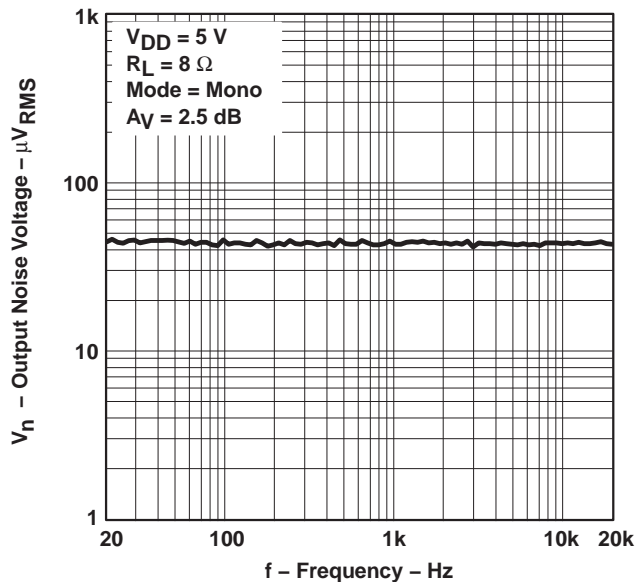

Figure 18

OUTPUT NOISE VOLTAGE
vs
FREQUENCY

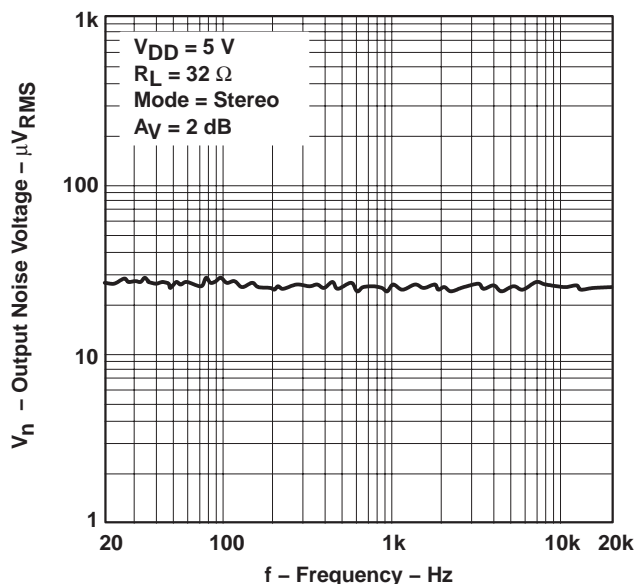

Figure 19

CLOSED LOOP RESPONSE

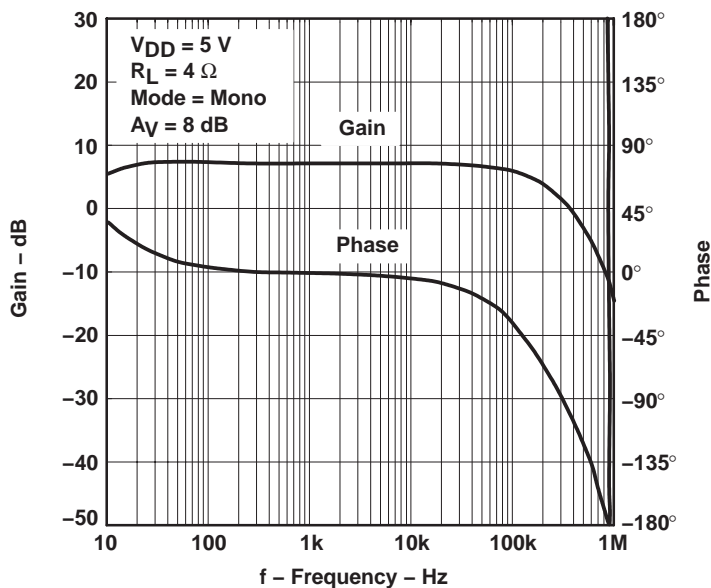

Figure 20



TYPICAL CHARACTERISTICS

CLOSED LOOP RESPONSE

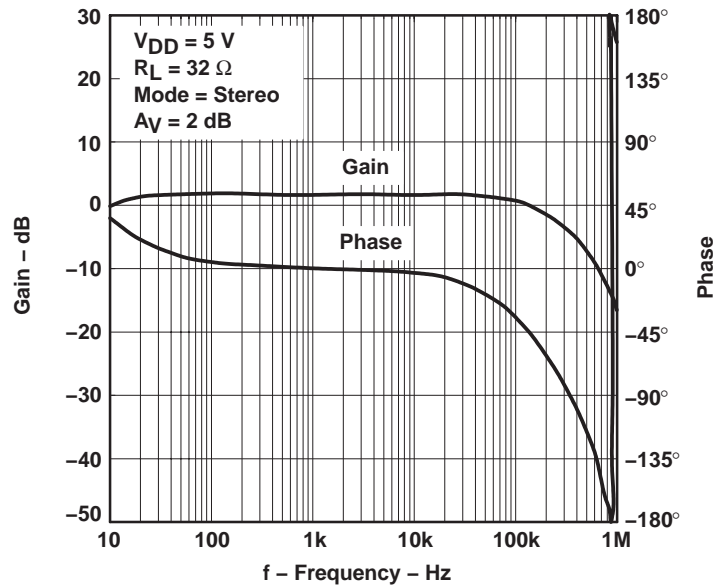

Figure 21

**CROSSTALK
 vs
 FREQUENCY**

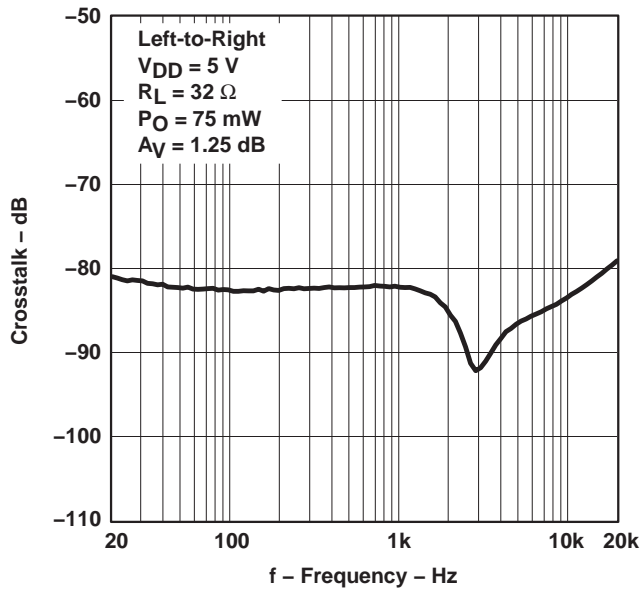

Figure 22

**CROSSTALK
 vs
 FREQUENCY**

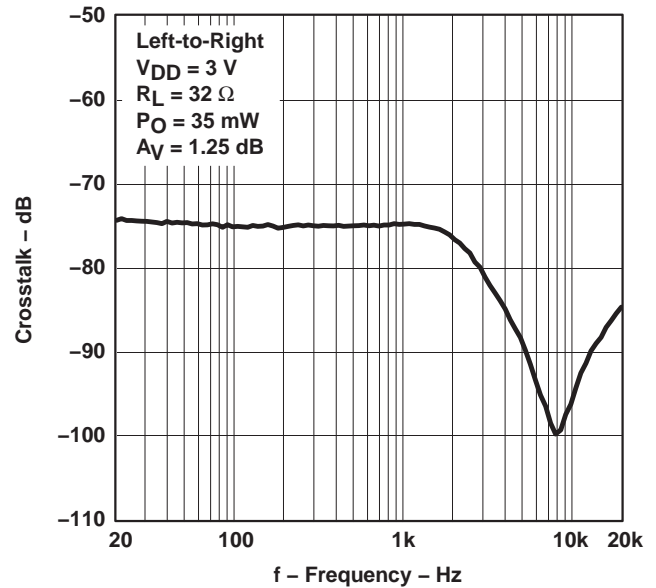

Figure 23

TPA0233
2-W MONO AUDIO POWER AMPLIFIER
WITH HEADPHONE DRIVE

SLOS278D – JANUARY 2000 – REVISED NOVEMBER 2002

APPLICATION INFORMATION

gain setting via input resistance

The gain of the input stage is set by the user-selected input resistor and a 50-kΩ internal feedback resistor.

However, the power stage is internally configured with a gain of –1.25 V/V in stereo mode, and –2.5 V/V in mono mode. Thus, the feedback resistor (R_F) is effectively 62.5 kΩ in stereo mode and 125 kΩ in mono mode. Therefore, the overall gain can be calculated using equations (1) and (2) stereo.

$$A_V = \frac{-125 \text{ k}\Omega}{R_I} \quad (\text{Mono}) \tag{1}$$

$$A_V = \frac{-62.5 \text{ k}\Omega}{R_I} \quad (\text{Stereo}) \tag{2}$$

The –3 dB frequency can be calculated using equation 3.

$$f_{-3 \text{ dB}} = \frac{1}{2\pi R_I C_i} \tag{3}$$

If the filter must be more accurate, the value of the capacitor should be increased while the value of the resistor to ground should be decreased. In addition, the order of the filter could be increased.

input capacitor, C_i

In the typical application an input capacitor (C_i), is required to allow the amplifier to bias the input signal to the proper dc level for optimum operation. In this case, C_i and the input resistance of the amplifier, R_I , form a high-pass filter with the corner frequency determined in equation 4.

$$f_{c(\text{highpass})} = \frac{1}{2\pi R_I C_i} \tag{4}$$

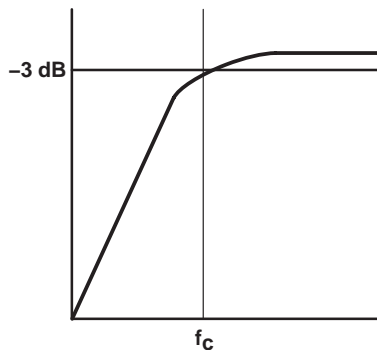

The value of C_i is important to consider as it directly affects the bass (low frequency) performance of the circuit. Consider the example where R_I is 10 kΩ and the specification calls for a flat bass response down to 40 Hz. Equation 2 is reconfigured as equation 5.

$$C_i = \frac{1}{2\pi R_I f_c} \tag{5}$$

In this example, C_i is 0.4 μF so one would likely choose a value in the range of 0.47 μF to 1 μF. A further consideration for this capacitor is the leakage path from the input source through the input network (C_i) and the feedback network to the load. This leakage current creates a dc offset voltage at the input to the amplifier that reduces useful headroom, especially in high gain applications. For this reason a low-leakage tantalum or ceramic capacitor is the best choice. When polarized capacitors are used, the positive side of the capacitor should face the amplifier input in most applications as the dc level there is held at $V_{DD}/2$, which is likely higher than the source dc level. Note that it is important to confirm the capacitor polarity in the application.



APPLICATION INFORMATION

power supply decoupling, $C_{(S)}$

The TPA0233 is a high-performance CMOS audio amplifier that requires adequate power supply decoupling to ensure the output total harmonic distortion (THD) is as low as possible. Power supply decoupling also prevents oscillations for long lead lengths between the amplifier and the speaker. The optimum decoupling is achieved by using two capacitors of different types that target different types of noise on the power supply leads. For higher frequency transients, spikes, or digital hash on the line, a good low equivalent-series-resistance (ESR) ceramic capacitor, typically 0.1 μF placed as close as possible to the device V_{DD} lead, works best. For filtering lower-frequency noise signals, a larger aluminum electrolytic capacitor of 10 μF or greater placed near the audio power amplifier is recommended.

midrail bypass capacitor, $C_{(\text{BYP})}$

The midrail bypass capacitor ($C_{(\text{BYP})}$), is the most critical capacitor and serves several important functions. During start-up or recovery from shutdown mode, $C_{(\text{BYP})}$ determines the rate at which the amplifier starts up. The second function is to reduce noise produced by the power supply caused by coupling into the output drive signal. This noise is from the midrail generation circuit internal to the amplifier, which appears as degraded PSRR and THD+N.

Bypass capacitor ($C_{(\text{BYP})}$), values of 0.47- μF to 1- μF ceramic or tantalum low-ESR capacitors are recommended for the best THD and noise performance.

output coupling capacitor, $C_{(C)}$

In the typical single-supply stereo configuration, an output coupling capacitor ($C_{(C)}$) is required to block the dc bias at the output of the amplifier, thus preventing dc currents in the load. As with the input coupling capacitor, the output coupling capacitor and impedance of the load form a high-pass filter governed by equation 6.

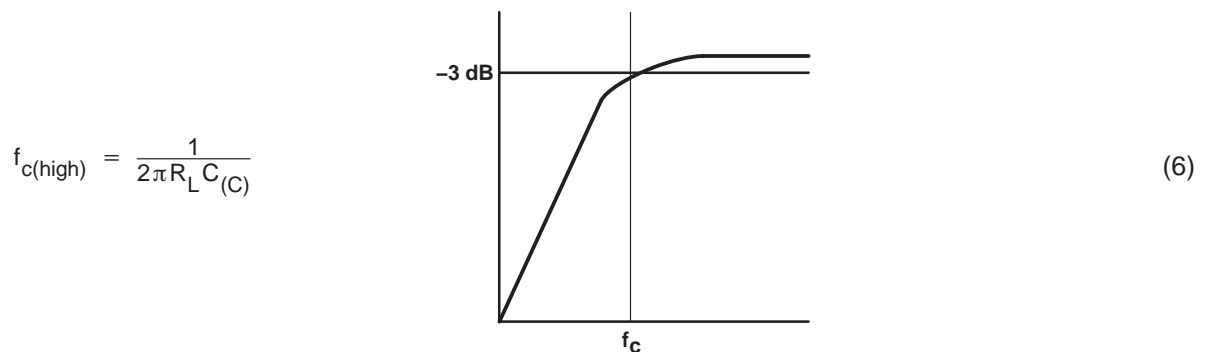

The main disadvantage, from a performance standpoint, is the load impedances are typically small, which drives the low-frequency corner higher, degrading the bass response. Large values of $C_{(C)}$ are required to pass low frequencies into the load. Consider the example where a $C_{(C)}$ of 330 μF is chosen and loads vary from 3 Ω , 4 Ω , 8 Ω , 32 Ω , 10 k Ω , to 47 k Ω . Table 1 summarizes the frequency response characteristics of each configuration.

Table 1. Common Load Impedances vs Low Frequency Output Characteristics in Stereo (SE) Mode

R_L	$C_{(C)}$	Lowest Frequency
3 Ω	330 μF	161 Hz
4 Ω	330 μF	120 Hz
8 Ω	330 μF	60 Hz
32 Ω	330 μF	15 Hz
10,000 Ω	330 μF	0.05 Hz
47,000 Ω	330 μF	0.01 Hz

TPA0233
2-W MONO AUDIO POWER AMPLIFIER
WITH HEADPHONE DRIVE

SLOS278D – JANUARY 2000 – REVISED NOVEMBER 2002

APPLICATION INFORMATION

output coupling capacitor, C_C (continued)

As Table 1 indicates, most of the bass response is attenuated into a 4-Ω load, an 8-Ω load is adequate, headphone response is good, and drive into line level inputs (a home stereo for example) is exceptional.

Furthermore, the total amount of ripple current that must flow through the capacitor must be considered when choosing the component. As shown in the application circuit, one coupling capacitor must be in series with the mono loudspeaker for proper operation of the stereo-mono switching circuit. For a 4-Ω load, this capacitor must be able to handle about 700 mA of ripple current for a continuous output power of 2 W.

using low-ESR capacitors

Low-ESR capacitors are recommended throughout this applications section. A real (as opposed to ideal) capacitor can be modeled simply as a resistor in series with an ideal capacitor. The voltage drop across this resistor minimizes the beneficial effects of the capacitor in the circuit. The lower the equivalent value of this resistance the more the real capacitor behaves like an ideal capacitor.

bridged-tied load versus single-ended mode

Figure 24 shows a Class-AB audio power amplifier (APA) in a BTL configuration. The TPA0233 BTL amplifier consists of two Class-AB amplifiers driving both ends of the load. There are several potential benefits to this differential drive configuration, but initially consider power to the load. The differential drive to the speaker means that as one side is slewing up, the other side is slewing down, and vice versa. This, in effect, doubles the voltage swing on the load as compared to a ground referenced load. Plugging $2 \times V_{O(PP)}$ into the power equation, where voltage is squared, yields $4 \times$ the output power from the same supply rail and load impedance. See equation 7.

$$V_{(RMS)} = \frac{V_{O(PP)}}{2\sqrt{2}} \tag{7}$$

$$\text{Power} = \frac{V_{(RMS)}^2}{R_L}$$

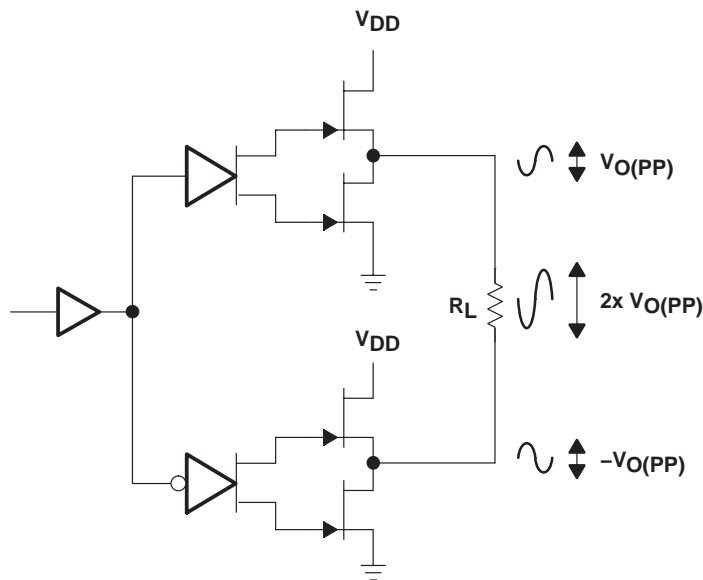

Figure 24. Bridge-Tied Load Configuration

APPLICATION INFORMATION

bridged-tied load versus single-ended mode (continued)

In a typical computer sound channel operating at 5 V, bridging raises the power into an 8-Ω speaker from a single-ended (SE, ground reference) limit of 250 mW to 1 W. In sound power, that is a 6-dB improvement—which is loudness that can be heard. In addition to increased power, there are frequency response concerns. Consider the single-supply SE configuration shown in Figure 25. A coupling capacitor is required to block the dc offset voltage from reaching the load. These capacitors can be quite large (approximately 33 μF to 1000 μF) so they tend to be expensive, heavy, occupy valuable PCB area, and have the additional drawback of limiting low-frequency performance of the system. This frequency limiting effect is due to the high-pass filter network created with the speaker impedance and the coupling capacitance and is calculated with equation 8.

$$f_c = \frac{1}{2\pi R_L C_{(C)}} \quad (8)$$

For example, a 68-μF capacitor with an 8-Ω speaker would attenuate low frequencies below 293 Hz. The BTL configuration cancels the dc offsets, which eliminates the need for the blocking capacitors. Low-frequency performance is then limited only by the input network and speaker response. Cost and PCB space are also minimized by eliminating the bulky coupling capacitor.

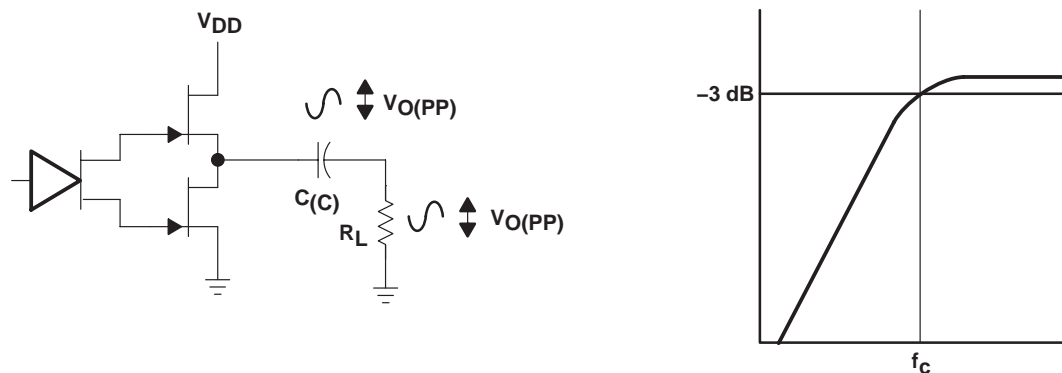

Figure 25. Single-Ended Configuration and Frequency Response

Increasing power to the load does carry a penalty of increased internal power dissipation. The increased dissipation is understandable considering that the BTL configuration produces 4× the output power of the SE configuration. Internal dissipation versus output power is discussed further in the *crest factor and thermal considerations* section.

single-ended (stereo) operation

In SE (stereo) mode (see Figure 24 and Figure 25), the load is driven from the primary amplifier output for each channel (LO and RO, terminals 6 and 10).

The amplifier switches to single-ended operation when the $\overline{ST/MN}$ terminal is held high.

input operation

The input allows stereo inputs to be applied to the amplifier. When the $\overline{ST/MN}$ terminal is held high, the inputs (LIN and RIN) drive the outputs as LO and RO in stereo mode. When the $\overline{ST/MN}$ terminal is held low, the inputs are surrounded internally to create the mono BTL signal, driving the outputs as MO+ and MO-.

APPLICATION INFORMATION

BTL amplifier efficiency

Class-AB amplifiers are inefficient. The primary cause of inefficiencies is the voltage drop across the output stage transistors. There are two components of the internal voltage drop. One is the headroom or dc voltage drop that varies inversely to output power. The second component is due to the sinewave nature of the output. The total voltage drop can be calculated by subtracting the RMS value of the output voltage from V_{DD} . The internal voltage drop multiplied by the RMS value of the supply current, I_{DDrms} , determines the internal power dissipation of the amplifier.

An easy-to-use equation to calculate efficiency starts out as being equal to the ratio of power from the power supply to the power delivered to the load. To accurately calculate the RMS and average values of power in the load and in the amplifier, the current and voltage waveform shapes must first be understood. See Figure 26.

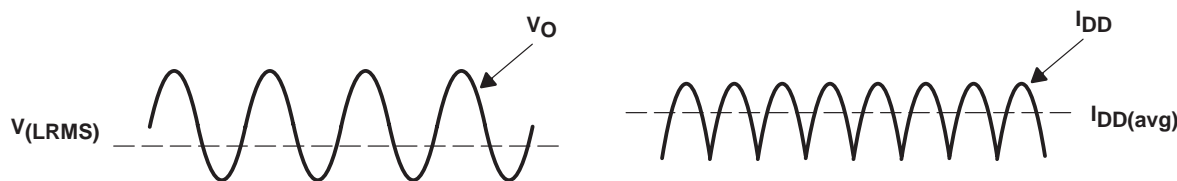

Figure 26. Voltage and Current Waveforms for BTL Amplifiers

Although the voltages and currents for SE and BTL are sinusoidal in the load, currents from the supply are very different between SE and BTL configurations. In an SE application the current waveform is a half-wave rectified shape, whereas in BTL it is a full-wave rectified waveform. This means RMS conversion factors are different. Keep in mind that for most of the waveform both the push and pull transistors are not on at the same time, which supports the fact that each amplifier in the BTL device only draws current from the supply for half the waveform. The following equations are the basis for calculating amplifier efficiency.

$$\text{Efficiency of a BTL amplifier} = \frac{P_L}{P_{SUP}} \tag{9}$$

where

$$P_L = \frac{V_{LRMS}^2}{R_L}, \text{ and } V_{LRMS} = \frac{V_P}{\sqrt{2}}, \text{ therefore, } P_L = \frac{V_P^2}{2R_L}$$

$$\text{and } P_{SUP} = V_{DD} I_{DDavg} \quad \text{and} \quad I_{DDavg} = \frac{1}{\pi} \int_0^\pi \frac{V_P}{R_L} \sin(t) dt = \frac{1}{\pi} \times \frac{V_P}{R_L} [\cos(t)]_0^\pi = \frac{2V_P}{\pi R_L}$$

therefore,

$$P_{SUP} = \frac{2 V_{DD} V_P}{\pi R_L}$$

substituting P_L and P_{SUP} into equation 9,

$$\text{Efficiency of a BTL amplifier} = \frac{\frac{V_P^2}{2R_L}}{\frac{2 V_{DD} V_P}{\pi R_L}} = \frac{\pi V_P}{4 V_{DD}}$$

where

$$V_P = \sqrt{2 P_L R_L}$$

APPLICATION INFORMATION

BTL amplifier efficiency (continued)

therefore,

$$\eta_{\text{BTL}} = \frac{\pi \sqrt{2 P_L R_L}}{4 V_{\text{DD}}} \quad (10)$$

P_L = Power delivered to load

P_{SUP} = Power drawn from power supply

V_{LRMS} = RMS voltage on BTL load

R_L = Load resistance

V_P = Peak voltage on BTL load

I_{DDavg} = Average current drawn from the power supply

V_{DD} = Power supply voltage

η_{BTL} = Efficiency of a BTL amplifier

Table 2 employs equation 10 to calculate efficiencies for four different output power levels. Note that the efficiency of the amplifier is quite low for lower power levels and rises sharply as power to the load is increased, resulting in a nearly flat internal power dissipation over the normal operating range. Note that the internal dissipation at full output power is less than in the half power range. Calculating the efficiency for a specific system is the key to proper power supply design. For a stereo 1-W audio system with 8- Ω loads and a 5-V supply, the maximum draw on the power supply is almost 3.25 W.

Table 2. Efficiency vs Output Power in 5-V, 8- Ω BTL Systems

Output Power (W)	Efficiency (%)	Peak Voltage (V)	Internal Dissipation (W)
0.25	31.4	2.00	0.55
0.50	44.4	2.83	0.62
1.00	62.8	4.00	0.59
1.25	70.2	4.47†	0.53

† High peak voltages cause the THD to increase.

A final point to remember about Class-AB amplifiers (either SE or BTL) is how to manipulate the terms in the efficiency equation to utmost advantage when possible. Note that in equation 10, V_{DD} is in the denominator. This indicates that as V_{DD} goes down, efficiency goes up.

crest factor and thermal considerations

Class-AB power amplifiers dissipate a significant amount of heat in the package under normal operating conditions. A typical music CD requires 12 dB to 15 dB of dynamic range, or headroom above the average power output, to pass the loudest portions of the signal without distortion. In other words, music typically has a crest factor between 12 dB and 15 dB. When determining the optimal ambient operating temperature, the internal dissipated power at the average output power level must be used. The TPA0233 data sheet shows that when the TPA0233 is operating from a 5-V supply into a 4- Ω speaker, 4-W peaks are available. Converting watts to dB:

$$P_{\text{dB}} = 10 \text{Log} \frac{P_W}{P_{\text{ref}}} = 10 \text{Log} \frac{4 \text{ W}}{1 \text{ W}} = 6 \text{ dB} \quad (11)$$

Subtracting the headroom restriction to obtain the average listening level without distortion yields

- 6 dB – 15 dB = –9 dB (15-dB crest factor)
- 6 dB – 12 dB = –6 dB (12-dB crest factor)
- 6 dB – 9 dB = –3 dB (9-dB crest factor)
- 6 dB – 6 dB = 0 dB (6-dB crest factor)
- 6 dB – 3 dB = 3 dB (3-dB crest factor)

TPA0233
2-W MONO AUDIO POWER AMPLIFIER
WITH HEADPHONE DRIVE

SLOS278D – JANUARY 2000 – REVISED NOVEMBER 2002

APPLICATION INFORMATION

crest factor and thermal considerations (continued)

Converting dB back into watts:

$$P_W = 10^{P_{dB}/10} \times P_{ref} \tag{12}$$

- = 63 mW (18-dB crest factor)
- = 125 mW (15-dB crest factor)
- = 250 mW (9-dB crest factor)
- = 500 mW (6-dB crest factor)
- = 1000 mW (3-dB crest factor)
- = 2000 mW (15-dB crest factor)

This is valuable information to consider when attempting to estimate the heat dissipation requirements for the amplifier system. Comparing the absolute worst case, which is 2 W of continuous power output with a 3-dB crest factor, against 12-dB and 15-dB applications drastically affects maximum ambient temperature ratings for the system. Table 3 shows maximum ambient temperatures and TPA0233 internal power dissipation for various output-power levels.

Table 3. TPA0233 Power Rating, 5-V, 3-Ω, Mono

PEAK OUTPUT POWER (W)	AVERAGE OUTPUT POWER	POWER DISSIPATION (W)	MAXIMUM AMBIENT TEMPERATURE
4	2 W (3-dB crest factor)	1.7	-3°C
4	1000 mW (6-dB crest factor)	1.6	6°C
4	500 mW (9-dB crest factor)	1.4	24°C
4	250 mW (12-dB crest factor)	1.1	51°C
4	125 mW (15-dB crest factor)	0.8	78°C
4	63 mW (18-dB crest factor)	0.6	96°C

Table 4. TPA0233 Power Rating, 5-V, 8-Ω, Stereo

PEAK OUTPUT POWER (W)	AVERAGE OUTPUT POWER	POWER DISSIPATION (W)	MAXIMUM AMBIENT TEMPERATURE
2.5	1250 mW (3-dB crest factor)	0.55	100°C
2.5	1000 mW (4-dB crest factor)	0.62	94°C
2.5	500 mW (7-dB crest factor)	0.59	97°C
2.5	250 mW (10-dB crest factor)	0.53	102°C

The maximum dissipated power (P_{Dmax}), is reached at a much lower output power level for an 8-Ω load than for a 4-Ω load. As a result, this simple formula for calculating P_{Dmax} may be used for a 4-Ω application.

$$P_{Dmax} = \frac{2V_{DD}^2}{\pi^2 R_L} \tag{13}$$

However, in the case of a 4-Ω load, the P_{Dmax} occurs at a point well above the normal operating power level. The amplifier may therefore be operated at a higher ambient temperature than required by the P_{Dmax} formula for a 4-Ω load.

The maximum ambient temperature depends on the heat sinking ability of the PCB system. The derating factor for the DGQ package is shown in the dissipation rating table. Converting this to Θ_{JA} :

$$\Theta_{JA} = \frac{1}{\text{Derating Factor}} = \frac{1}{0.0171} = 58.48^\circ\text{C/W} \tag{14}$$



APPLICATION INFORMATION

crest factor and thermal considerations (continued)

To calculate maximum ambient temperatures, first consider that the numbers from the dissipation graphs are per channel so the dissipated power needs to be doubled for two channel operation. Given Θ_{JA} , the maximum allowable junction temperature, and the total internal dissipation, the maximum ambient temperature can be calculated with the following equation. The maximum recommended junction temperature for the TPA0233 is 150°C. The internal dissipation figures are taken from the Power Dissipation vs Output Power graphs.

$$T_A \text{ Max} = T_J \text{ Max} - \Theta_{JA} P_D = 150 - 58.48(0.8 \times 2) = 56^\circ\text{C} \text{ (15-dB crest factor)} \quad (15)$$

NOTE:

Internal dissipation of 0.8 W is estimated for a 2-W system with 15-dB crest factor per channel.

Tables 3 and 4 show that for some applications no airflow is required to keep junction temperatures in the specified range. The TPA0233 is designed with thermal protection that turns the device off when the junction temperature surpasses 150°C to prevent damage to the IC. Tables 3 and 4 were calculated for maximum listening volume without distortion. When the output level is reduced the numbers in the table change significantly. Also, using 8- Ω speakers dramatically increases the thermal performance by increasing amplifier efficiency.

ST/MN (stereo/mono) operation

The ability of the TPA0233 to easily switch between mono BTL and stereo SE modes is one of its most important cost saving features. This feature eliminates the requirement for an additional headphone amplifier in applications where an internal speaker is driven in BTL mode but external stereo headphone or speakers must be accommodated. When ST/MN is held high, the RIN and LIN inputs drive the output as Lo and Ro in stereo SE mode. When ST/MN is held low, the inputs are summed internally and the output is driven as Mo+ and Mo– in mono BTL mode. Control of the ST/MN input can be from a logic-level CMOS source or, more typically, from a switch-controlled resistor divider network as shown in the functional block diagram.

PACKAGING INFORMATION

Orderable Device	Status (1)	Package Type	Package Drawing	Pins	Package Qty	Eco Plan (2)	Lead finish/ Ball material (6)	MSL Peak Temp (3)	Op Temp (°C)	Device Marking (4/5)	Samples
TPA0233DGQ	ACTIVE	HVSSOP	DGQ	10	80	RoHS & Green	NIPDAU	Level-1-260C-UNLIM	-40 to 125	AEJ	Samples
TPA0233DGQR	ACTIVE	HVSSOP	DGQ	10	2500	RoHS & Green	NIPDAU	Level-1-260C-UNLIM	-40 to 125	AEJ	Samples

(1) The marketing status values are defined as follows:

ACTIVE: Product device recommended for new designs.

LIFEBUY: TI has announced that the device will be discontinued, and a lifetime-buy period is in effect.

NRND: Not recommended for new designs. Device is in production to support existing customers, but TI does not recommend using this part in a new design.

PREVIEW: Device has been announced but is not in production. Samples may or may not be available.

OBSOLETE: TI has discontinued the production of the device.

(2) **RoHS:** TI defines "RoHS" to mean semiconductor products that are compliant with the current EU RoHS requirements for all 10 RoHS substances, including the requirement that RoHS substance do not exceed 0.1% by weight in homogeneous materials. Where designed to be soldered at high temperatures, "RoHS" products are suitable for use in specified lead-free processes. TI may reference these types of products as "Pb-Free".

RoHS Exempt: TI defines "RoHS Exempt" to mean products that contain lead but are compliant with EU RoHS pursuant to a specific EU RoHS exemption.

Green: TI defines "Green" to mean the content of Chlorine (Cl) and Bromine (Br) based flame retardants meet JS709B low halogen requirements of <=1000ppm threshold. Antimony trioxide based flame retardants must also meet the <=1000ppm threshold requirement.

(3) MSL, Peak Temp. - The Moisture Sensitivity Level rating according to the JEDEC industry standard classifications, and peak solder temperature.

(4) There may be additional marking, which relates to the logo, the lot trace code information, or the environmental category on the device.

(5) Multiple Device Markings will be inside parentheses. Only one Device Marking contained in parentheses and separated by a "~" will appear on a device. If a line is indented then it is a continuation of the previous line and the two combined represent the entire Device Marking for that device.

(6) Lead finish/Ball material - Orderable Devices may have multiple material finish options. Finish options are separated by a vertical ruled line. Lead finish/Ball material values may wrap to two lines if the finish value exceeds the maximum column width.

Important Information and Disclaimer:The information provided on this page represents TI's knowledge and belief as of the date that it is provided. TI bases its knowledge and belief on information provided by third parties, and makes no representation or warranty as to the accuracy of such information. Efforts are underway to better integrate information from third parties. TI has taken and continues to take reasonable steps to provide representative and accurate information but may not have conducted destructive testing or chemical analysis on incoming materials and chemicals. TI and TI suppliers consider certain information to be proprietary, and thus CAS numbers and other limited information may not be available for release.

In no event shall TI's liability arising out of such information exceed the total purchase price of the TI part(s) at issue in this document sold by TI to Customer on an annual basis.

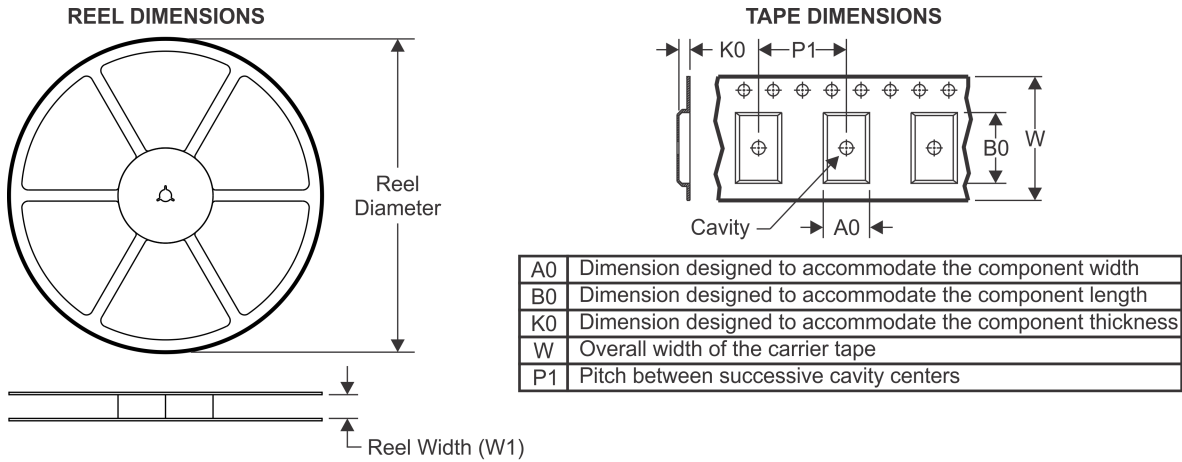
TAPE AND REEL INFORMATION

QUADRANT ASSIGNMENTS FOR PIN 1 ORIENTATION IN TAPE

*All dimensions are nominal

Device	Package Type	Package Drawing	Pins	SPQ	Reel Diameter (mm)	Reel Width W1 (mm)	A0 (mm)	B0 (mm)	K0 (mm)	P1 (mm)	W (mm)	Pin1 Quadrant
TPA0233DGQR	HVSSOP	DGQ	10	2500	330.0	12.4	5.3	3.4	1.4	8.0	12.0	Q1

TAPE AND REEL BOX DIMENSIONS



*All dimensions are nominal

Device	Package Type	Package Drawing	Pins	SPQ	Length (mm)	Width (mm)	Height (mm)
TPA0233DGQR	HVSSOP	DGQ	10	2500	358.0	335.0	35.0

GENERIC PACKAGE VIEW

DGQ 10

PowerPAD™ HVSSOP - 1.1 mm max height

3 x 3, 0.5 mm pitch

PLASTIC SMALL OUTLINE

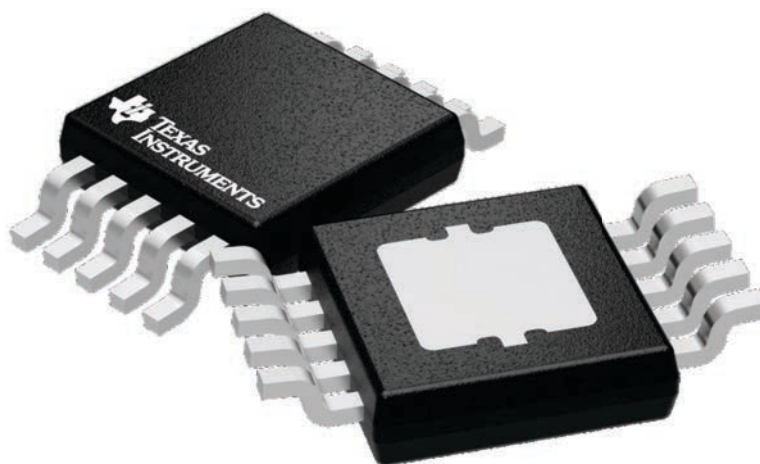

Images above are just a representation of the package family, actual package may vary.
Refer to the product data sheet for package details.

4224775/A

DGQ0010D

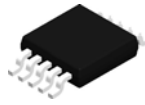

PACKAGE OUTLINE

PowerPAD™ - 1.1 mm max height

PLASTIC SMALL OUTLINE

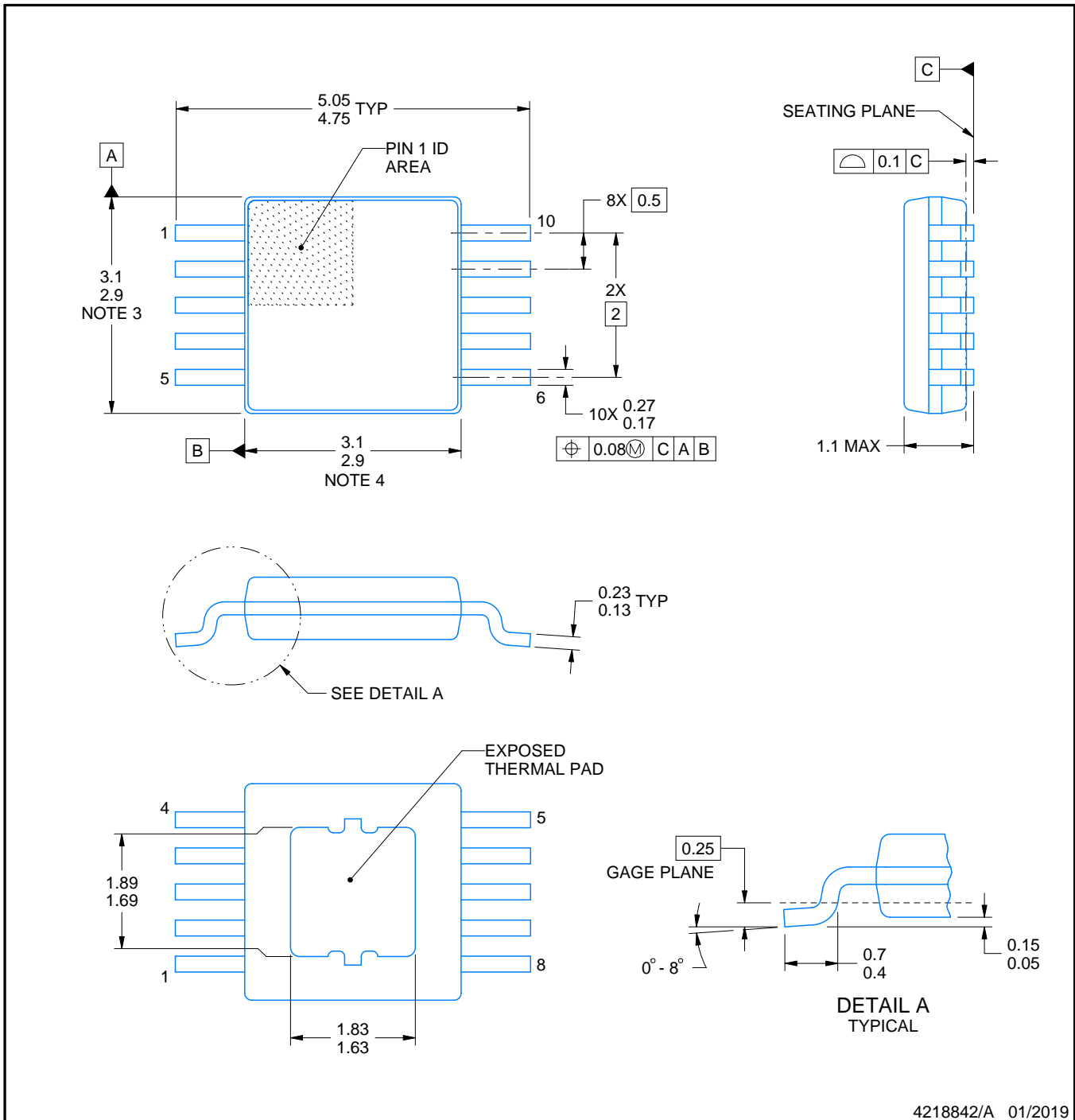

4218842/A 01/2019

PowerPAD is a trademark of Texas Instruments.

NOTES:

1. All linear dimensions are in millimeters. Any dimensions in parenthesis are for reference only. Dimensioning and tolerancing per ASME Y14.5M.
2. This drawing is subject to change without notice.
3. This dimension does not include mold flash, protrusions, or gate burrs. Mold flash, protrusions, or gate burrs shall not exceed 0.15 mm per side.
4. This dimension does not include interlead flash. Interlead flash shall not exceed 0.25 mm per side.
5. Reference JEDEC registration MO-187, variation BA-T.

EXAMPLE STENCIL DESIGN

DGQ0010D

PowerPAD™ - 1.1 mm max height

PLASTIC SMALL OUTLINE

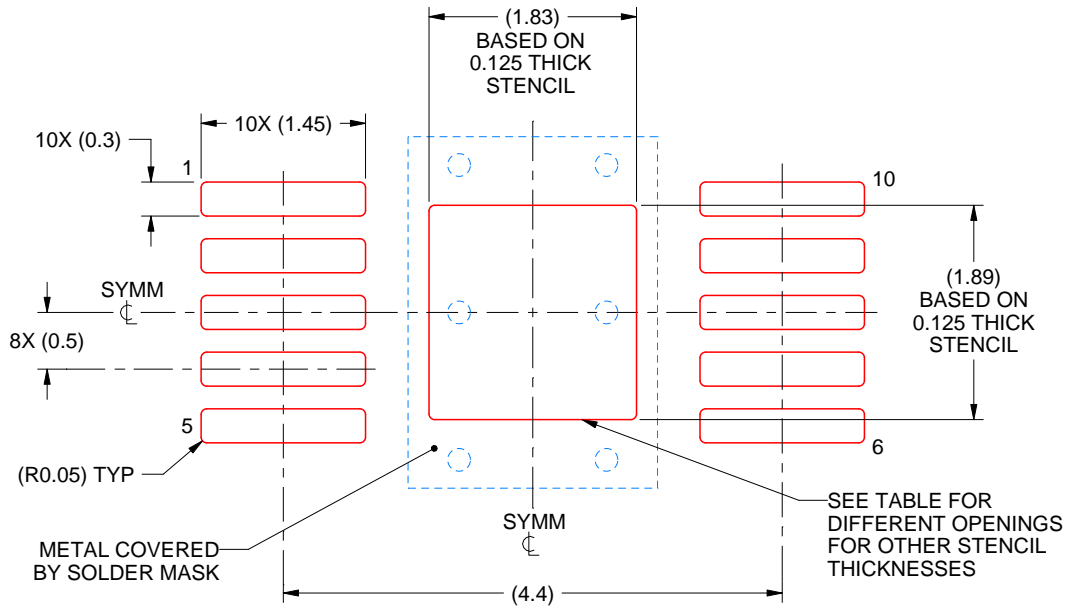

SOLDER PASTE EXAMPLE
 EXPOSED PAD
 100% PRINTED SOLDER COVERAGE BY AREA
 SCALE:15X

STENCIL THICKNESS	SOLDER STENCIL OPENING
0.1	2.05 X 2.11
0.125	1.83 X 1.89 (SHOWN)
0.150	1.67 X 1.73
0.175	1.55 X 1.60

4218842/A 01/2019

NOTES: (continued)

10. Laser cutting apertures with trapezoidal walls and rounded corners may offer better paste release. IPC-7525 may have alternate design recommendations.
11. Board assembly site may have different recommendations for stencil design.

IMPORTANT NOTICE AND DISCLAIMER

TI PROVIDES TECHNICAL AND RELIABILITY DATA (INCLUDING DATASHEETS), DESIGN RESOURCES (INCLUDING REFERENCE DESIGNS), APPLICATION OR OTHER DESIGN ADVICE, WEB TOOLS, SAFETY INFORMATION, AND OTHER RESOURCES "AS IS" AND WITH ALL FAULTS, AND DISCLAIMS ALL WARRANTIES, EXPRESS AND IMPLIED, INCLUDING WITHOUT LIMITATION ANY IMPLIED WARRANTIES OF MERCHANTABILITY, FITNESS FOR A PARTICULAR PURPOSE OR NON-INFRINGEMENT OF THIRD PARTY INTELLECTUAL PROPERTY RIGHTS.

These resources are intended for skilled developers designing with TI products. You are solely responsible for (1) selecting the appropriate TI products for your application, (2) designing, validating and testing your application, and (3) ensuring your application meets applicable standards, and any other safety, security, or other requirements. These resources are subject to change without notice. TI grants you permission to use these resources only for development of an application that uses the TI products described in the resource. Other reproduction and display of these resources is prohibited. No license is granted to any other TI intellectual property right or to any third party intellectual property right. TI disclaims responsibility for, and you will fully indemnify TI and its representatives against, any claims, damages, costs, losses, and liabilities arising out of your use of these resources.

TI's products are provided subject to TI's Terms of Sale (<https://www.ti.com/legal/termsofsale.html>) or other applicable terms available either on [ti.com](https://www.ti.com) or provided in conjunction with such TI products. TI's provision of these resources does not expand or otherwise alter TI's applicable warranties or warranty disclaimers for TI products.

Mailing Address: Texas Instruments, Post Office Box 655303, Dallas, Texas 75265
Copyright © 2021, Texas Instruments Incorporated

Looking for pricing, stock, or lifecycle information?

Click below to explore more details on WIN SOURCE:

 [View TPA0233DGQ](#) on WIN SOURCE

 [Texas Instruments](#) Information

Optimize Your Supply Chain with WIN SOURCE Solutions

-  Global Sourcing Solution
-  Obsolete Management
-  Cost Control Management
-  Shortage Management
-  Alternative Solution
-  Excess Inventory Management