



# THE DATASHEET OF MAN3R10



**0.3 Inch (7.62mm) COMPACT  
LOW CURRENT NUMERIC FRAME DISPLAY**

**AllnGaP Red (630nm) MAN3H10, MAN3H40**  
**AllnGaP Red (642nm) MAN3R10, MAN3R40**  
**AllnGaP Yellow MAN3Y10, MAN3Y40**  
**GaP Green MAN3G10, MAN3G40**

TR/QTS/030100-002

PACKAGE DIMENSIONS	FEATURES	
<p>Technical drawing showing package dimensions. Key dimensions include: top width 0.300 (7.62), top height 0.24 (6.10), total height 0.390 (9.91), segment height 0.200 (5.08), lead width 0.150 (3.81), lead pitch 0.100 (2.54), lead thickness 0.020 (0.508), bottom width 0.200 (5.08), bottom lead width 0.010 (0.25), bottom lead angle 10°, bottom lead length 0.117 (2.97), bottom lead offset 0.035 (0.89), bottom lead width 0.168 (4.27), and total bottom width 0.500 (12.70).</p>	<ul style="list-style-type: none"> <li>•Bright Bold Segments</li> <li>•Common Anode/Cathode</li> <li>•Low Power Consumption</li> <li>•Low Current Capability</li> <li>•Neutral Segments</li> <li>•Grey Face</li> <li>•Epoxy Encapsulated Frame</li> <li>•High Performance</li> <li>•High Reliability</li> </ul>	
<p><b>NOTES:</b></p> <ul style="list-style-type: none"> <li>•Dimensions are in inches (mm)</li> <li>•Tolerances are +/- 0.010 (0.25) unless otherwise stated.</li> </ul>	<th style="background-color: #0056b3; color: white;">APPLICATIONS</th> <ul style="list-style-type: none"> <li>•Appliances</li> <li>•Automotive</li> <li>•Instrumentation</li> <li>•Process Control</li> </ul>	APPLICATIONS

MODELS AVAILABLE			
Part Number	Colour	Description	Recommended I <sub>F</sub> Levels
MAN3H10	AllnGaP 630nm	Single Digit, RHDP, Common Anode	Low Current (1mA - 5mA)
MAN3H40	AllnGaP 630nm	Single Digit, RHDP, Common Cathode	Low Current (1mA - 5mA)
MAN3R10	AllnGaP 642nm	Single Digit, RHDP, Common Anode	Low Current (1mA - 5mA)
MAN3R40	AllnGaP 642nm	Single Digit, RHDP, Common Cathode	Low Current (1mA - 5mA)
MAN3Y10	AllnGaP Yellow	Single Digit, RHDP, Common Anode	Low Current (1mA - 5mA)
MAN3Y40	AllnGaP Yellow	Single Digit, RHDP, Common Cathode	Low Current (1mA - 5mA)
MAN3G10	GaP Green	Single Digit, RHDP, Common Anode	Low Current (1mA - 5mA)
MAN3G40	GaP Green	Single Digit, RHDP, Common Cathode	Low Current (1mA - 5mA)

(For other colour options, contact your local area Sales Manager)

### ABSOLUTE MAXIMUM RATINGS<sup>(1)</sup> ( $T_A = 25^\circ\text{C}$ , unless otherwise specified)

Part Number	MAN3H10	MAN3R10	MAN3Y10	MAN3G10	
Parameter	MAN3H40	MAN3R40	MAN3Y40	MAN3G40	Units
<b>Continuous Forward Current</b> (each segment)	25	25	25	25	mA
<b>Peak Forward Current</b> ( $F = 10\text{KHz}$ , $D/F = 1/10$ )	100	100	100	100	mA
<b>Power Dissipation (<math>P_D</math>)</b>	60	60	60	60	mW
<b>*Derate Linearly from 25°C</b>	0.36	0.36	0.36	0.36	mW
<b>Reverse Voltage per Die</b>	5 Volts				
<b>Operating and Storage Temperature Range</b>	-40°C to +85°C				
<b>Lead soldering time (1/16 inch from standoffs)</b>	5 seconds @ 230°C				

### ELECTRO-OPTICAL CHARACTERISTICS<sup>(1)</sup> ( $T_A = 25^\circ\text{C}$ , unless otherwise specified)

Part Number	MAN3H10	MAN3R10	MAN3Y10	MAN3G10		
Parameter	MAN3H40	MAN3R40	MAN3Y40	MAN3G40	Units	Test Condition
<b>Luminous intensity<sup>(2)</sup> (<math>I_V</math>)</b>						
Minimum (Standard Current)	Note 4	Note 4	Note 4	1500	ucd	$I_F = 10\text{mA}$
Typical (Standard Current)	Note 4	Note 4	Note 4	2500	ucd	$I_F = 10\text{mA}$
Minimum (Low Current)	510	510	510	510	ucd	$I_F = 2\text{mA}$
Typical (Low Current)	1000	1000	1000	1000	ucd	$I_F = 2\text{mA}$
<b>Forward Voltage (<math>V_F</math>)</b>						
Typical (Standard Current)	2.05	2.05	2.05	2.05	Volts	$I_F = 10\text{mA}$
Maximum (Standard Current)	2.45	2.45	2.45	2.45	Volts	$I_F = 10\text{mA}$
Typical (Low Current)	1.80	1.80	1.80	1.80	Volts	$I_F = 2\text{mA}$
Maximum (Low Current)	2.20	2.20	2.20	2.20	Volts	$I_F = 2\text{mA}$
<b>Peak Wavelength</b>	632	639	591	565	nm	$I_F = 10\text{mA}$
<b>Dominant Wavelength</b>	624	631	585	570	nm	$I_F = 10\text{mA}$
<b>Spectral Line 1/2 Width</b>	20	20	20	20	nm	$I_F = 10\text{mA}$
<b>Reverse B<sup>(3)</sup>.Voltage (<math>V_R</math>)</b>	5	5	5	5	Volts	$I_R = 100\mu\text{A}$

**NOTES:**

(1) Data per individual LED element

(2) Luminous intensity (ucd) = average light output per segment

(3) B = breakdown

(4) High current operation of these Superbright Displays results in cross-talk (light bleed from a lit to a non lit segment) - maximum drive current recommended to contain cross-talk is 5mA

**PIN ORIENTATION, SEGMENT IDENTIFICATION, AND PRODUCT MARKING**

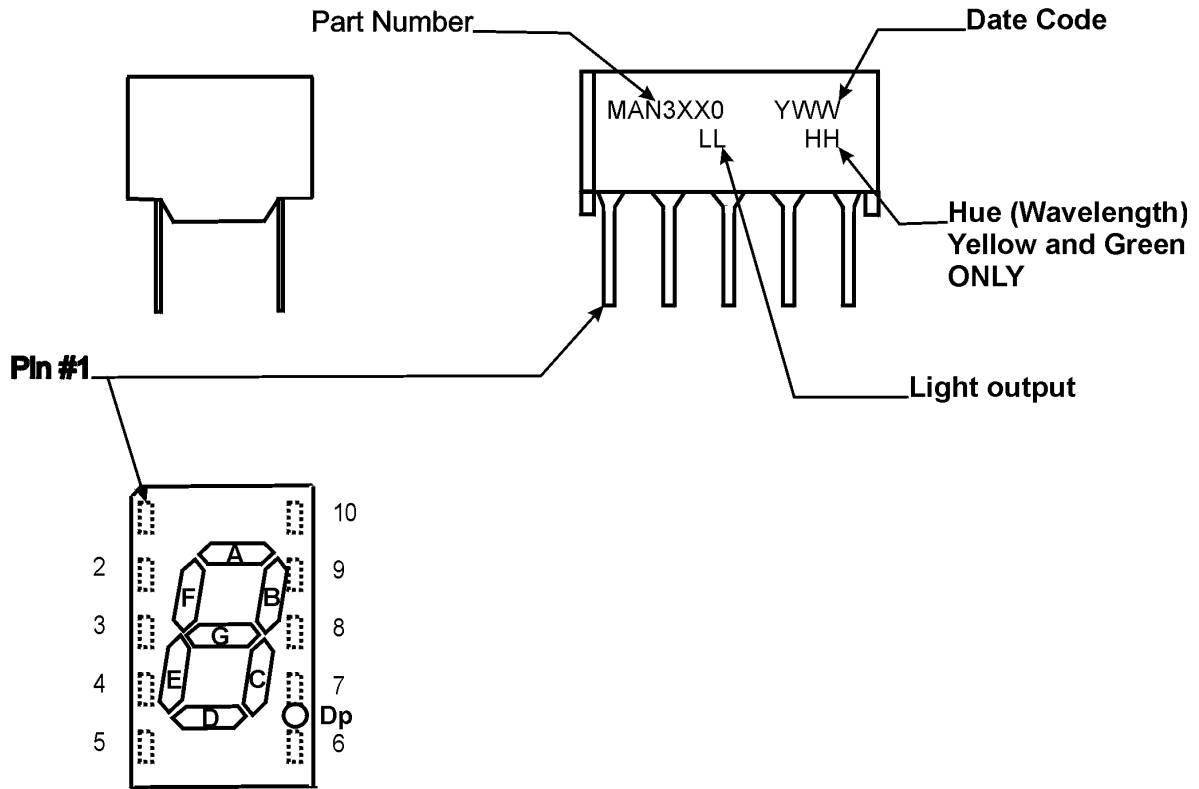

**SCHEMATICS**

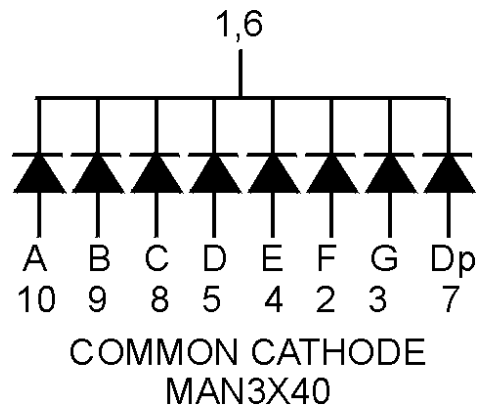
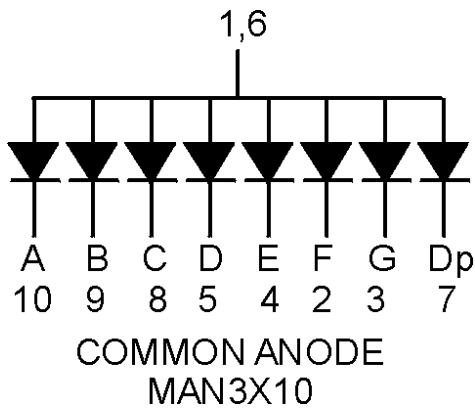

**GRAPHICAL DATA AlInGaP 630nm ( $T_A = 25^\circ\text{C}$ , unless otherwise specified)**

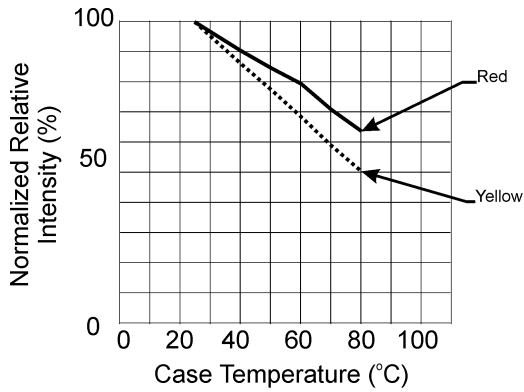

Relative Intensity vs Case Temp.

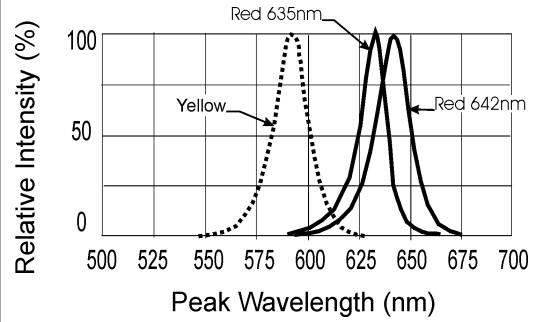

Spectral Response

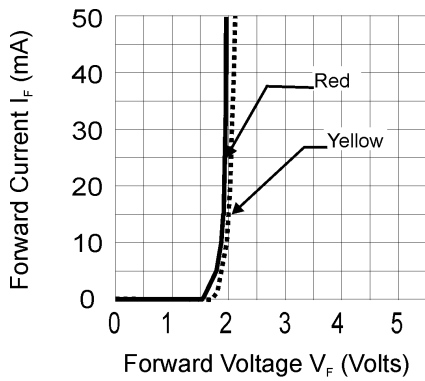

Forward Current vs Forward Voltage

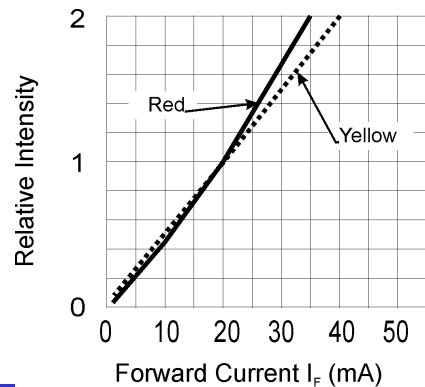

Luminous Intensity vs Duty Cycle

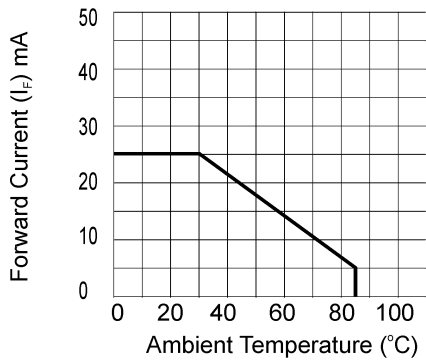

Maximum Forward Current vs Ambient Temperature

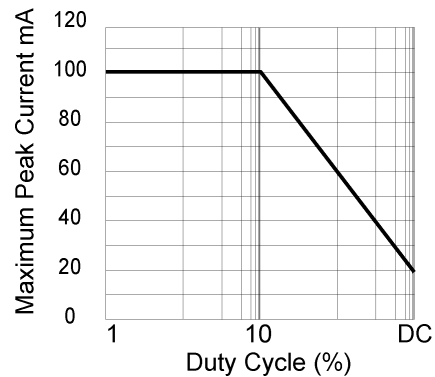

Maximum Peak Current vs Duty Cycle

**GRAPHICAL DATA GaP Green ( $T_A = 25^\circ\text{C}$ , unless otherwise specified)**

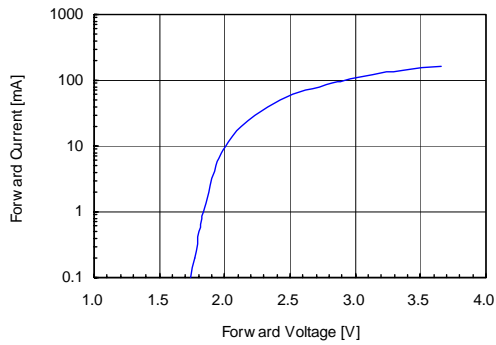

**Forward Current vs Forward Voltage**

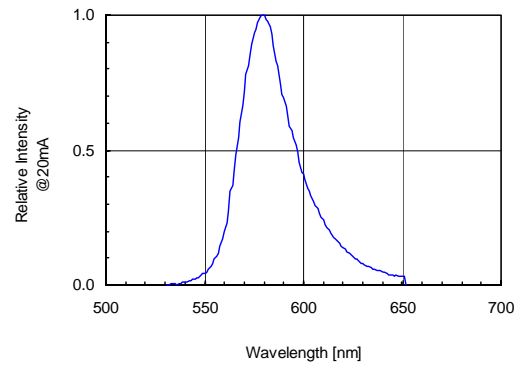

**Spectral Response**

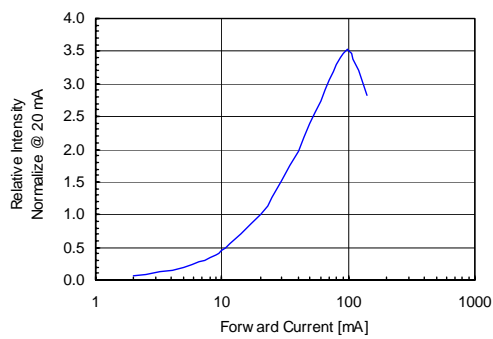

**Relative Intensity vs Forward Current**

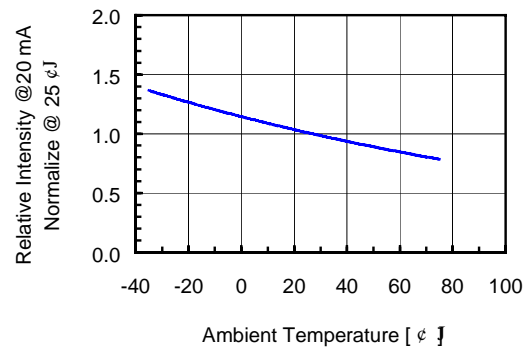

**Relative Intensity vs Ambient Temperature**

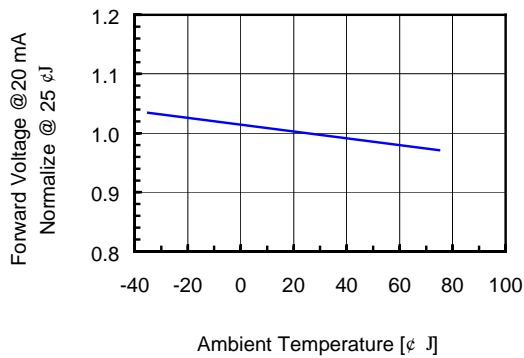

**Forward Voltage vs Ambient Temperature**



## 0.3 Inch (7.62mm) COMPACT LOW CURRENT NUMERIC FRAME DISPLAY

---

### DISCLAIMER

FAIRCHILD SEMICONDUCTOR RESERVES THE RIGHT TO MAKE CHANGES WITHOUT FURTHER NOTICE TO ANY PRODUCTS HEREIN TO IMPROVE RELIABILITY, FUNCTION OR DESIGN. FAIRCHILD DOES NOT ASSUME ANY LIABILITY ARISING OUT OF THE APPLICATION OR USE OF ANY PRODUCT OR CIRCUIT DESCRIBED HEREIN; NEITHER DOES IT CONVEY ANY LICENSE UNDER ITS PATENT RIGHTS, NOR THE RIGHTS OF OTHERS.



### LIFE SUPPORT POLICY

FAIRCHILD'S PRODUCTS ARE NOT AUTHORIZED FOR USE AS CRITICAL COMPONENTS IN LIFE SUPPORT DEVICES OR SYSTEMS WITHOUT THE EXPRESS WRITTEN APPROVAL OF THE PRESIDENT OF FAIRCHILD SEMICONDUCTOR CORPORATION. As used herein:

1. Life support devices or systems are devices or systems which, (a) are intended for surgical implant into the body, or (b) support or sustain life, and (c) whose failure to perform when properly used in accordance with instructions for use provided in the labeling, can be reasonably expected to result in a significant injury of the user.
2. A critical component in any component of a life support device or system whose failure to perform can be reasonably expected to cause the failure of the life support device or system, or to affect its safety or effectiveness.

## Looking for pricing, stock, or lifecycle information?

Click below to explore more details on WIN SOURCE:

-  [View MAN3R10 on WIN SOURCE](#)
-  [Fairchild/ON Semiconductor Information](#)

## Optimize Your Supply Chain with WIN SOURCE Solutions

-  Global Sourcing Solution
-  Obsolete Management
-  Cost Control Management
-  Shortage Management
-  Alternative Solution
-  Excess Inventory Management