



## General Description

The AOZ8251 is a one-line bidirectional transient voltage suppressor diode designed to protect high speed data lines and voltage sensitive electronics from high transient conditions and ESD.

This device incorporates one bidirectional TVS diode in an ultra-small 0201 footprint package. It may be used to meet the ESD immunity requirements of IEC 61000-4-2, Level 4 ( $\pm 15$  kV air,  $\pm 15$  kV contact discharge).

The AOZ8251 comes in an RoHS compliant package and is rated over a  $-40$  °C to  $+85$  °C ambient temperature range.

The ultra-small 0.6mm x 0.3 mm x 0.3 mm 0201 footprint package makes the AOZ8251 ideal for applications where PCB space is a premium. The small size and high ESD protection makes it ideal for protecting voltage sensitive electronics from high transient conditions and ESD.

## Features

- ESD protection for high-speed data lines:
  - Exceeds: IEC 61000-4-2 (ESD)  $\pm 30$  kV (air),  $\pm 25$  kV (contact)
  - Human Body Model (HBM)  $\pm 25$  kV
- Small package saves board space
- Low capacitance: 8.0 pF
- Low clamping voltage
- Low operating voltage: 5.0 V
- Pb-free device

## Applications

- Portable handheld devices
- Keypads, data lines, buttons
- Notebook computers
- Digital Cameras
- Portable GPS
- MP3 players



## Typical Application

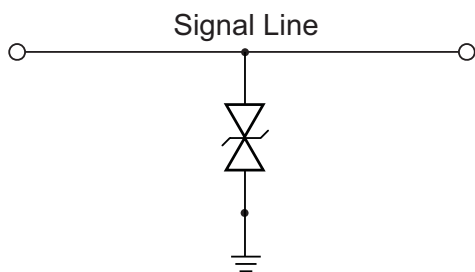

**Bidirection Protection of Single Line**

## Pin Configuration



## Ordering Information

Part Number	Ambient Temperature Range	Package	Environmental
AOZ8251DI-05	-40 °C to +85 °C	DFN 0.6 x 0.3	Green Product



AOS Green Products use reduced levels of Halogens, and are also RoHS compliant. Please visit [www.aosmd.com/media/AOSGreenPolicy.pdf](http://www.aosmd.com/media/AOSGreenPolicy.pdf) for additional information.

## Absolute Maximum Ratings

*Exceeding the Absolute Maximum Ratings may damage the device.*

Parameter	Rating
VP – VN	5 V
Peak Pulse Current (I <sub>PP</sub> ), t <sub>P</sub> = 8/20µs	2 A
Peak Pulse Power, t <sub>P</sub> = 8/20µs	40 W
Storage Temperature (T <sub>S</sub> )	-65 °C to +150 °C
ESD Rating per IEC61000-4-2, Contact <sup>(1)</sup>	±25 kV
ESD Rating per IEC61000-4-2, Air <sup>(1)</sup>	±30 kV
ESD Rating per Human Body Model <sup>(2)</sup>	±25 kV

### Notes:

- IEC 61000-4-2 discharge with C<sub>Discharge</sub> = 150 pF, R<sub>Discharge</sub> = 330 Ω.
- Human Body Discharge per MIL-STD-883, Method 3015 C<sub>Discharge</sub> = 100 pF, R<sub>Discharge</sub> = 1.5 kΩ.

## Maximum Operating Conditions

*The device is not guaranteed to operate beyond the Maximum Operating Conditions.*

Parameter	Rating
Junction Temperature (T <sub>J</sub> )	-40 °C to +125 °C

### Electrical Characteristics

T<sub>A</sub> = 25°C unless otherwise specified.

Symbol	Parameter	Diagram
I <sub>PP</sub>	Maximum Reverse Peak Pulse Current	
V <sub>CL</sub>	Clamping Voltage @ I <sub>PP</sub>	
V <sub>RWM</sub>	Working Peak Reverse Voltage	
I <sub>R</sub>	Maximum Reverse Leakage Current	
V <sub>BR</sub>	Breakdown Voltage	
I <sub>F</sub>	Forward Current	
V <sub>F</sub>	Forward Voltage	
P <sub>PK</sub>	Peak Power Dissipation	
C <sub>J</sub>	Capacitance @ V <sub>R</sub> = 0 and f = 1 MHz	

Device	Device Marking	V <sub>RWM</sub> (V) Max.	V <sub>BR</sub> (V) Min.	I <sub>R</sub> (μA) Max.	V <sub>F</sub> (V) Typ.	V <sub>CL</sub> Max.			C <sub>J</sub> (pF) Typ.
						I <sub>PP</sub> = 1 A	I <sub>PP</sub> = 2 A	I <sub>PP</sub> = 5 A	
AOZ8251DI-05	B	5.0	6.0	0.1	1.0	14.00	16.00	19.50	8.0

## Typical Performance Characteristics

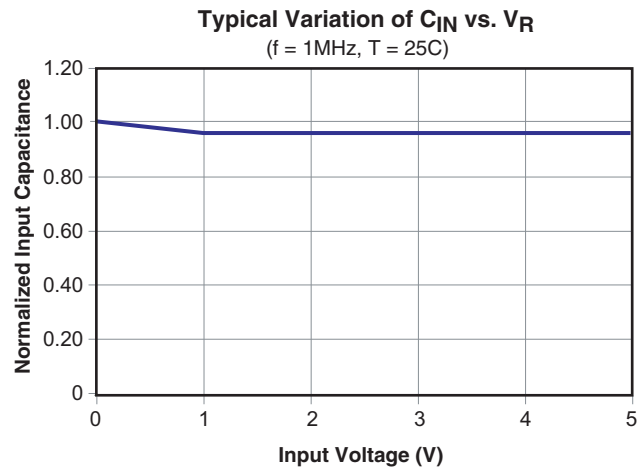
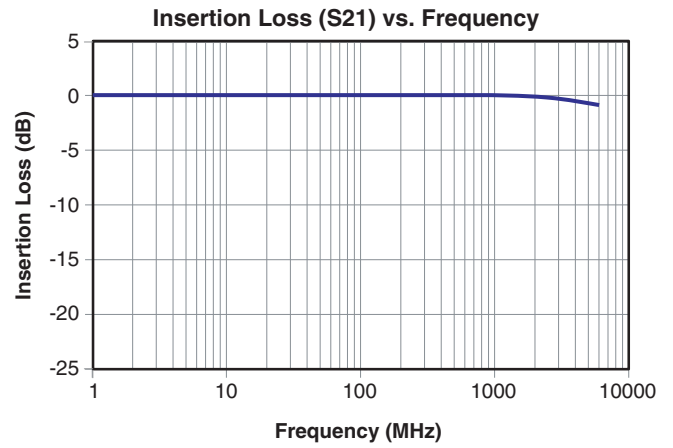
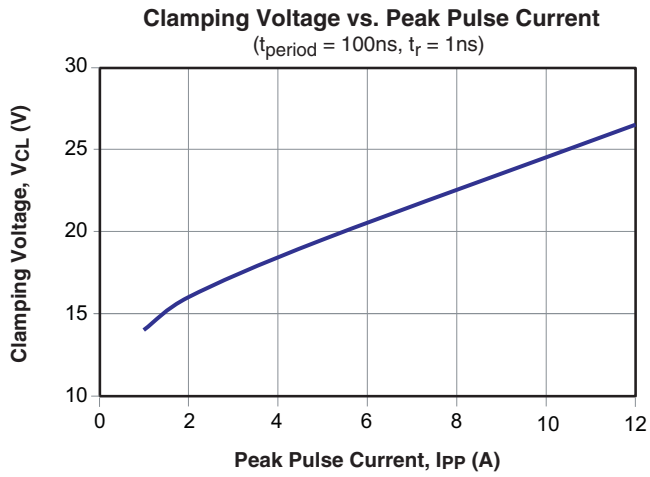

Package Dimensions, DFN 0.6x0.3, 2L EP2 S

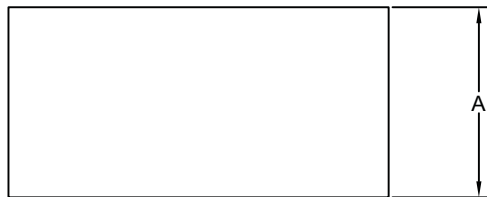
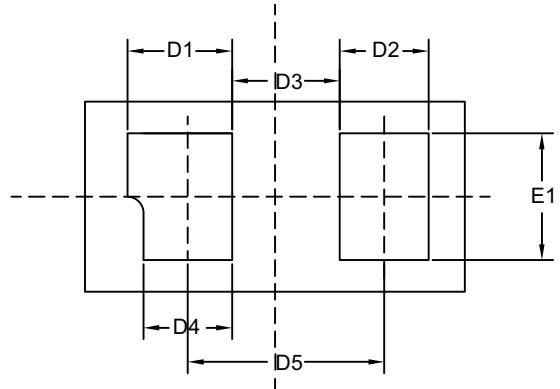
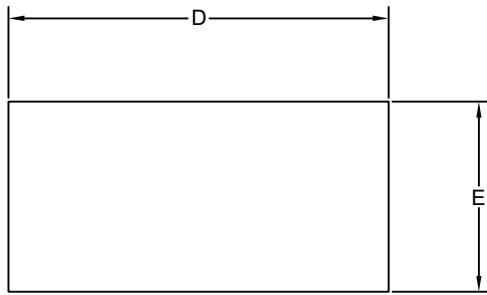

RECOMMENDED LAND PATTERN

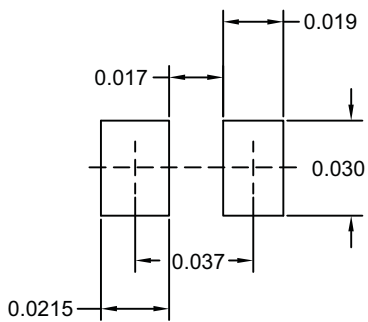

Unit: mm

Dimensions in millimeters

Symbols	Min.	Nom.	Max.
A	0.27	0.30	0.33
D	0.55	0.60	0.65
D1	0.165 TYP		
D2	0.14 TYP		
D3	0.17 TYP		
D4	0.14 TYP		
D5	0.31 TYP		
E	0.25	0.30	0.35
E1	0.20 TYP		

Dimensions in inches

Symbols	Min.	Nom.	Max.
A	0.0106	0.0118	0.0130
D	0.0216	0.0236	0.0256
D1	0.0065 TYP		
D2	0.0055 TYP		
D3	0.0067 TYP		
D4	0.0055 TYP		
D5	0.0122 TYP		
E	0.0098	0.0118	0.0138
E1	0.0079 TYP		

Notes:

1. All dimensions are in millimeters.
2. Dimensions are inclusive of plating.
3. Package body sizes exclude mold flash and gate burrs. Mold flash at the non-lead sides should be less than 6mil each.
4. Controlling dimension is millimeter. Converted inch dimensions are not necessarily exact.
5. Paddle exposed on bottom.

## Part Marking

**AOZ8251DI-05**  
(DFN0.6x0.3)

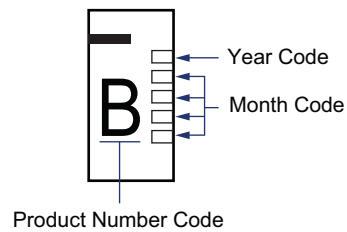

### LEGAL DISCLAIMER

Alpha and Omega Semiconductor makes no representations or warranties with respect to the accuracy or completeness of the information provided herein and takes no liabilities for the consequences of use of such information or any product described herein. Alpha and Omega Semiconductor reserves the right to make changes to such information at any time without further notice. This document does not constitute the grant of any intellectual property rights or representation of non-infringement of any third party's intellectual property rights.

### LIFE SUPPORT POLICY

ALPHA AND OMEGA SEMICONDUCTOR PRODUCTS ARE NOT AUTHORIZED FOR USE AS CRITICAL COMPONENTS IN LIFE SUPPORT DEVICES OR SYSTEMS.

As used herein:

1. Life support devices or systems are devices or systems which, (a) are intended for surgical implant into the body or (b) support or sustain life, and (c) whose failure to perform when properly used in accordance with instructions for use provided in the labeling, can be reasonably expected to result in a significant injury of the user.
2. A critical component in any component of a life support, device, or system whose failure to perform can be reasonably expected to cause the failure of the life support device or system, or to affect its safety or effectiveness.

## Looking for pricing, stock, or lifecycle information?

Click below to explore more details on WIN SOURCE:

- ⊖ [View AOZ8251DI-05 on WIN SOURCE](#)
- ⊖ [Alpha & Omega Semiconductor Inc. Information](#)

## Optimize Your Supply Chain with WIN SOURCE Solutions

- ✓ Global Sourcing Solution
- ✓ Obsolete Management
- ✓ Cost Control Management
- ✓ Shortage Management
- ✓ Alternative Solution
- ✓ Excess Inventory Management