



THE DATASHEET OF LMV844QMA/NOPB



LMV84x CMOS Input, RRIO, Low Power, Wide Supply Range, 4.5-MHz Operational Amplifiers

1 Features

- Unless Otherwise Noted, Typical Values at $T_A = 25\text{ }^\circ\text{C}$, $V^+ = 5\text{ V}$.
- Small 5-Pin SC70 Package (2.00 mm × 1.25 mm × 0.95 mm)
- Wide Supply Voltage Range: 2.7 V to 12 V
- Specified Performance at 3.3 V, 5 V and $\pm 5\text{ V}$
- Low Supply Current: 1 mA Per Channel
- Unity Gain Bandwidth: 4.5 MHz
- Open-Loop Gain: 133 dB
- Input Offset Voltage: 500 μV Maximum
- Input Bias Current: 0.3 pA
- CMRR at 112 dB and PSSR at 108 dB
- Input Voltage Noise: 20 $\text{nV}/\sqrt{\text{Hz}}$
- Temperature Range: $-40\text{ }^\circ\text{C}$ to $125\text{ }^\circ\text{C}$
- Rail-to-Rail Input and Output (RRIO)

2 Applications

- High Impedance Sensor Interface
- Battery-Powered Instrumentation
- High Gain and Instrumentation Amplifiers
- DAC Buffers and Active Filters

3 Description

The LMV84x devices are low-voltage and low-power operational amplifiers that operate with supply voltages ranging from 2.7 V to 12 V and have rail-to-rail input and output capability. Their low offset voltage, low supply current, and CMOS inputs make them ideal for high impedance sensor interface and battery-powered applications.

The single LMV841 is offered in the space-saving 5-pin SC70 package, the dual LMV842 in the 8-pin VSSOP and 8-pin SOIC packages, and the quad LMV844 in the 14-pin TSSOP and 14-pin SOIC packages. These small packages are ideal solutions for area-constrained PCBs and portable electronics.

Device Information⁽¹⁾

PART NUMBER	PACKAGE	BODY SIZE (NOM)
LMV841	SC70 (5)	2.00 mm × 1.25 mm
LMV842	VSSOP (8)	3.00 mm × 3.00 mm
	SOIC (8)	4.90 mm × 3.91 mm
LMV844	SOIC (14)	8.65 mm × 3.91 mm
	TSSOP (14)	5.00 mm × 4.40 mm

(1) For all available packages, see the orderable addendum at the end of the data sheet.

Typical Applications

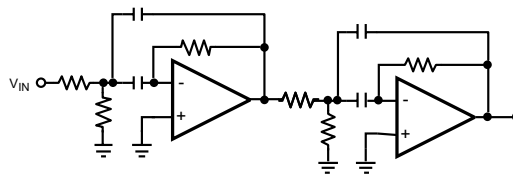

Active Band-Pass Filter

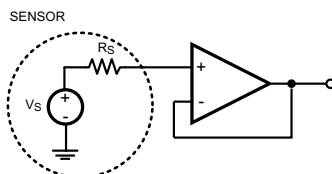

High Impedance Sensor Interface
CMOS Input Feature

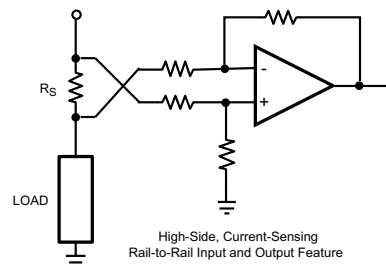

High-Side, Current-Sensing
Rail-to-Rail Input and Output Feature

Copyright © 2016, Texas Instruments Incorporated



Table of Contents

1 Features	1	7.4 Device Functional Modes.....	17
2 Applications	1	7.5 Interfacing to High Impedance Sensor	20
3 Description	1	8 Application and Implementation	21
4 Revision History	2	8.1 Application Information.....	21
5 Pin Configuration and Functions	3	8.2 Typical Applications	21
6 Specifications	4	9 Power Supply Recommendations	25
6.1 Absolute Maximum Ratings	4	10 Layout	25
6.2 ESD Ratings.....	4	10.1 Layout Guidelines	25
6.3 Recommended Operating Conditions.....	4	10.2 Layout Example	25
6.4 Thermal Information	4	11 Device and Documentation Support	26
6.5 Electrical Characteristics – 3.3 V	5	11.1 Related Links	26
6.6 Electrical Characteristics – 5 V	6	11.2 Receiving Notification of Documentation Updates	26
6.7 Electrical Characteristics – ± 5 -V	7	11.3 Community Resources.....	26
6.8 Typical Characteristics.....	10	11.4 Trademarks	26
7 Detailed Description	16	11.5 Electrostatic Discharge Caution.....	26
7.1 Overview	16	11.6 Glossary	26
7.2 Functional Block Diagram	16	12 Mechanical, Packaging, and Orderable Information	26
7.3 Feature Description.....	16		

4 Revision History

NOTE: Page numbers for previous revisions may differ from page numbers in the current version.

Changes from Revision H (July 2016) to Revision I	Page
• Changed <i>ESD Ratings</i> table footnotes to TI standard	4
• Changed <i>Thermal Information</i> table	4
• Changed Phase Margin vs C_L graphic	13
• Changed Overshoot vs C_L graphic.....	14

Changes from Revision G (February 2013) to Revision H	Page
• Added <i>ESD Ratings</i> table, <i>Feature Description</i> section, <i>Device Functional Modes</i> , <i>Application and Implementation</i> section, <i>Power Supply Recommendations</i> section, <i>Layout</i> section, <i>Device and Documentation Support</i> section, and <i>Mechanical, Packaging, and Orderable Information</i> section.	1

Changes from Revision F (February 2013) to Revision G	Page
• Changed layout of National Semiconductor Data Sheet to TI format	23

5 Pin Configuration and Functions

**DCK Package
5-Pin SC70
Top View**

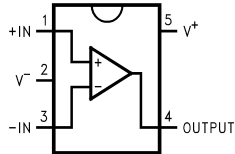

**D or DGK Package
8-Pin SOIC and VSSOP
Top View**

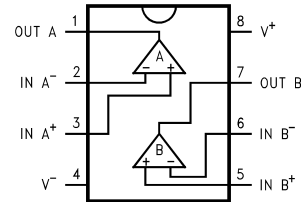

**D or PW Package
14-Pin SOIC and TSSOP
Top View**

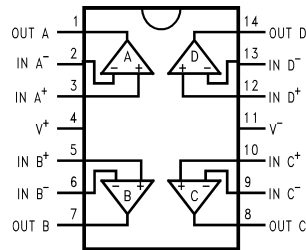

Pin Functions

PIN		DESCRIPTION
NAME	I/O.	
+IN	I	Noninverting Input
-IN	I	Inverting Input
OUT	O	Output
V+	P	Positive Supply
V-	P	Negative Supply

6 Specifications

6.1 Absolute Maximum Ratings

See ⁽¹⁾⁽²⁾

		MIN	MAX	UNIT
V _{IN} differential		-300	300	mV
Supply voltage (V ⁺ – V ⁻)			13.2	V
Voltage at input and output pins		V ⁺ + 0.3	V ⁻ – 0.3	V
Input current			10	mA
Junction temperature ⁽³⁾			150	°C
Soldering information	Infrared or convection (20 s)		235	°C
	Wave soldering lead temperature (10 s)		260	°C
Storage temperature, T _{stg}		-65	150	°C

- (1) Stresses beyond those listed under *Absolute Maximum Ratings* may cause permanent damage to the device. These are stress ratings only and functional operation of the device at these conditions is not implied. Exposure to absolute-maximum-rated conditions for extended periods may affect device reliability.
- (2) If Military/Aerospace specified devices are required, contact the Texas Instruments Sales Office / Distributors for availability and specifications.
- (3) The maximum power dissipation is a function of T_{J(MAX)}, R_{θJA}, and T_A. The maximum allowable power dissipation at any ambient temperature is P_D = (T_{J(MAX)} - T_A) / R_{θJA}. All numbers apply for packages soldered directly onto a PCB.

6.2 ESD Ratings

			VALUE	UNIT
V _(ESD)	Electrostatic discharge	Human-body model (HBM) ⁽¹⁾	±2000	V
		Charged-device model (CDM), per JEDEC specification JESD22-C101 ⁽²⁾	±250	

- (1) JEDEC document JEP155 states that 500-V HBM allows safe manufacturing with a standard ESD control process.
- (2) JEDEC document JEP157 states that 250-V CDM allows safe manufacturing with a standard ESD control process.

6.3 Recommended Operating Conditions

		MIN	MAX	UNIT
Temperature ⁽¹⁾		-40	125	°C
Supply voltage (V ⁺ – V ⁻)		2.7	12	V

- (1) The maximum power dissipation is a function of T_{J(MAX)}, R_{θJA}, and T_A. The maximum allowable power dissipation at any ambient temperature is P_D = (T_{J(MAX)} - T_A) / R_{θJA}. All numbers apply for packages soldered directly onto a PCB.

6.4 Thermal Information

THERMAL METRIC ⁽¹⁾		LMV84x					UNIT
		DCK (SC70)	DGK (VSSOP)	D (SOIC)		PW (TSSOP)	
		5 PINS	8 PINS	8 PINS	14 PIN	14 PINS	
R _{θJA}	Junction-to-ambient thermal resistance ⁽²⁾	269.9	179.2	121.4	85.4	113.3	°C/W
R _{θJC(top)}	Junction-to-case (top) thermal resistance	93.8	69.2	65.7	43.5	38.9	°C/W
R _{θJB}	Junction-to-board thermal resistance	48.8	99.7	62.0	39.8	56.3	°C/W
ψ _{JT}	Junction-to-top characterization parameter	2.0	10.0	16.5	9.2	3.1	°C/W
ψ _{JB}	Junction-to-board characterization parameter	47.9	98.3	61.4	39.6	55.6	°C/W
R _{θJC(bot)}	Junction-to-case (bottom) thermal resistance	N/A	N/A	N/A	N/A	N/A	°C/W

- (1) For more information about traditional and new thermal metrics, see the [Semiconductor and IC Package Thermal Metrics](#) application report.
- (2) The maximum power dissipation is a function of T_{J(MAX)}, R_{θJA}, and T_A. The maximum allowable power dissipation at any ambient temperature is P_D = (T_{J(MAX)} - T_A) / R_{θJA}. All numbers apply for packages soldered directly onto a PCB.

6.5 Electrical Characteristics – 3.3 V

Unless otherwise specified, all limits are ensured for $T_A = 25^\circ\text{C}$, $V^+ = 3.3\text{ V}$, $V^- = 0\text{ V}$, $V_{\text{CM}} = V^+ / 2$, and $R_L > 10\text{ M}\Omega$ to $V^+ / 2$.⁽¹⁾

PARAMETER		TEST CONDITIONS		MIN ⁽²⁾	TYP ⁽³⁾	MAX ⁽²⁾	UNIT
V_{OS}	Input offset voltage			–500	±50	500	μV
		at the temperature extremes		–800		800	
TCV_{OS}	Input offset voltage drift ⁽⁴⁾				0.5		$\mu\text{V}/^\circ\text{C}$
		at the temperature extremes		–5		5	
I_{B}	Input bias current ^{(4) (5)}				0.3	10	pA
		at the temperature extremes				300	
I_{OS}	Input offset current				40		fA
CMRR	Common-mode rejection ratio LMV841	$0\text{ V} \leq V_{\text{CM}} \leq 3.3\text{ V}$		84	112		dB
			at the temperature extremes	80			
CMRR	Common-mode rejection ratio LMV842 and LMV844	$0\text{ V} \leq V_{\text{CM}} \leq 3.3\text{ V}$		77	106		dB
			at the temperature extremes	75			
PSRR	Power supply rejection ratio	$2.7\text{ V} \leq V^+ \leq 12\text{ V}$, $V_{\text{O}} = V^+ / 2$		86	108		dB
			at the temperature extremes	82			
CMVR	Input common-mode voltage range	CMRR $\geq 50\text{ dB}$, at the temperature extremes		–0.1		3.4	V
A_{VOL}	Large signal voltage gain	$R_L = 2\text{ k}\Omega$ $V_{\text{O}} = 0.3\text{ V to } 3\text{ V}$		100	123		dB
			at the temperature extremes	96			
A_{VOL}	Large signal voltage gain	$R_L = 10\text{ k}\Omega$ $V_{\text{O}} = 0.2\text{ V to } 3.1\text{ V}$		100	131		dB
			at the temperature extremes	96			
V_{O}	Output swing high, (measured from V^+)	$R_L = 2\text{ k}\Omega$ to $V^+/2$			52	80	mV
			at the temperature extremes			120	
	Output swing high, (measured from V^+)	$R_L = 10\text{ k}\Omega$ to $V^+/2$			28	50	mV
			at the temperature extremes			70	
Output swing low, (measured from V^-)	$R_L = 2\text{ k}\Omega$ to $V^+/2$			65	100	mV	
		at the temperature extremes			120		
Output swing low, (measured from V^-)	$R_L = 10\text{ k}\Omega$ to $V^+/2$			33	65	mV	
		at the temperature extremes			75		

(1) Electrical table values apply only for factory testing conditions at the temperature indicated. Factory testing conditions result in very limited self-heating of the device.

(2) Limits are 100% production tested at 25°C . Limits over the operating temperature range are ensured through correlations using statistical quality control (SQC) method.

(3) Typical values represent the most likely parametric norm as determined at the time of characterization. Actual typical values may vary over time and will also depend on the application and configuration. The typical values are not tested and are not ensured on shipped production material.

(4) This parameter is ensured by design and/or characterization and is not tested in production.

(5) Positive current corresponds to current flowing into the device.

Electrical Characteristics – 3.3 V (continued)

Unless otherwise specified, all limits are ensured for $T_A = 25^\circ\text{C}$, $V^+ = 3.3\text{ V}$, $V^- = 0\text{ V}$, $V_{\text{CM}} = V^+ / 2$, and $R_L > 10\text{ M}\Omega$ to $V^+ / 2$.⁽¹⁾

PARAMETER		TEST CONDITIONS	MIN ⁽²⁾	TYP ⁽³⁾	MAX ⁽²⁾	UNIT
I_O	Output short-circuit current ⁽⁶⁾⁽⁷⁾	Sourcing $V_O = V^+ / 2$ $V_{\text{IN}} = 100\text{ mV}$		20	32	mA
			at the temperature extremes	15		
		Sinking $V_O = V^+ / 2$ $V_{\text{IN}} = -100\text{ mV}$		20	27	mA
			at the temperature extremes	15		
I_S	Supply current	Per channel		0.93	1.5	mA
			at the temperature extremes			
SR	Slew rate ⁽⁸⁾	$A_V = 1$, $V_O = 2.3\text{ V}_{\text{PP}}$ 10% to 90%		2.5		V/ μs
GBW	Gain bandwidth product			4.5		MHz
Φ_m	Phase margin			67		Deg
e_n	Input-referred voltage noise	$f = 1\text{ kHz}$		20		nV/ $\sqrt{\text{Hz}}$
R_{OUT}	Open-loop output impedance	$f = 3\text{ MHz}$		70		Ω
THD+N	Total harmonic distortion + noise	$f = 1\text{ kHz}$, $A_V = 1$ $R_L = 10\text{ k}\Omega$		0.005%		
C_{IN}	Input capacitance			7		pF

(6) The maximum power dissipation is a function of $T_{\text{J(MAX)}}$, $R_{\theta\text{JA}}$, and T_A . The maximum allowable power dissipation at any ambient temperature is $P_D = (T_{\text{J(MAX)}} - T_A) / R_{\theta\text{JA}}$. All numbers apply for packages soldered directly onto a PCB.

(7) Short circuit test is a momentary test.

(8) Number specified is the slower of positive and negative slew rates.

6.6 Electrical Characteristics – 5 V

Unless otherwise specified, all limits are ensured for $T_A = 25^\circ\text{C}$, $V^+ = 5\text{ V}$, $V^- = 0\text{ V}$, $V_{\text{CM}} = V^+ / 2$, and $R_L > 10\text{ M}\Omega$ to $V^+ / 2$.⁽¹⁾

PARAMETER		TEST CONDITIONS	MIN ⁽²⁾	TYP ⁽³⁾	MAX ⁽²⁾	UNIT
V_{OS}	Input offset voltage		-500	± 50	500	μV
		at the temperature extremes	-800		800	
TCV_{OS}	Input offset voltage drift ⁽⁴⁾			0.35		$\mu\text{V}/^\circ\text{C}$
		at the temperature extremes	-5		5	
I_B	Input bias current ⁽⁴⁾⁽⁵⁾			0.3	10	pA
		at the temperature extremes			300	
I_{OS}	Input offset current			40		fA
CMRR	Common-mode rejection ratio LMV841	$0\text{ V} \leq V_{\text{CM}} \leq 5\text{ V}$		86	112	dB
			at the temperature extremes	80		
	Common-mode rejection ratio LMV842 and LMV844	$0\text{ V} \leq V_{\text{CM}} \leq 5\text{ V}$		81	106	dB
			at the temperature extremes	79		
PSRR	Power supply rejection ratio	$2.7\text{ V} \leq V^+ \leq 12\text{ V}$, $V_O = V^+ / 2$		86	108	dB
			at the temperature extremes	82		

(1) Electrical table values apply only for factory testing conditions at the temperature indicated. Factory testing conditions result in very limited self-heating of the device.

(2) Limits are 100% production tested at 25°C . Limits over the operating temperature range are ensured through correlations using statistical quality control (SQC) method.

(3) Typical values represent the most likely parametric norm as determined at the time of characterization. Actual typical values may vary over time and will also depend on the application and configuration. The typical values are not tested and are not ensured on shipped production material.

(4) This parameter is ensured by design and/or characterization and is not tested in production.

(5) Positive current corresponds to current flowing into the device.

Electrical Characteristics – 5 V (continued)

Unless otherwise specified, all limits are ensured for $T_A = 25^\circ\text{C}$, $V^+ = 5\text{ V}$, $V^- = 0\text{ V}$, $V_{\text{CM}} = V^+ / 2$, and $R_L > 10\text{ M}\Omega$ to $V^+ / 2$.⁽¹⁾

PARAMETER		TEST CONDITIONS		MIN ⁽²⁾	TYP ⁽³⁾	MAX ⁽²⁾	UNIT
CMVR	Input common-mode voltage range	CMRR $\geq 50\text{ dB}$, at the temperature extremes		-0.2		5.2	V
A _{VOL}	Large signal voltage gain	R _L = 2 k Ω V _O = 0.3V to 4.7 V		100	125		dB
			at the temperature extremes	96			
A _{VOL}	Large signal voltage gain	R _L = 10 k Ω V _O = 0.2V to 4.8V		100	133		dB
			at the temperature extremes	96			
V _O	Output swing high, (measured from V ⁺)	R _L = 2 k Ω to V ⁺ /2			68	100	mV
			at the temperature extremes			120	
	Output swing low, (measured from V ⁻)	R _L = 10 k Ω to V ⁺ /2			32	50	mV
			at the temperature extremes			70	
Output swing low, (measured from V ⁻)	R _L = 2 k Ω to V ⁺ /2			78	120	mV	
		at the temperature extremes			140		
Output swing low, (measured from V ⁻)	R _L = 10 k Ω to V ⁺ /2			38	70	mV	
		at the temperature extremes			80		
I _O	Output short-circuit current ^{(6) (7)}	Sourcing V _O = V ⁺ /2 V _{IN} = 100 mV		20	33		mA
			at the temperature extremes	15			
I _O	Output short-circuit current ^{(6) (7)}	Sinking V _O = V ⁺ /2 V _{IN} = -100 mV		20	28		mA
			at the temperature extremes	15			
I _S	Supply current	Per channel			0.96	1.5	mA
			at the temperature extremes			2	
SR	Slew rate ⁽⁸⁾	A _V = 1, V _O = 4 V _{PP} 10% to 90%			2.5		V/ μs
GBW	Gain bandwidth product				4.5		MHz
Φ_m	Phase margin				67		Deg
e _n	Input-referred voltage noise	f = 1 kHz			20		nV/ $\sqrt{\text{Hz}}$
R _{OUT}	Open-loop output impedance	f = 3 MHz			70		Ω
THD+N	Total harmonic distortion + noise	f = 1 kHz, A _V = 1 R _L = 10 k Ω			0.003%		
C _{IN}	Input capacitance				6		pF

(6) The maximum power dissipation is a function of $T_{\text{J(MAX)}}$, $R_{\theta\text{JA}}$, and T_A . The maximum allowable power dissipation at any ambient temperature is $P_D = (T_{\text{J(MAX)}} - T_A) / R_{\theta\text{JA}}$. All numbers apply for packages soldered directly onto a PCB.

(7) Short circuit test is a momentary test.

(8) Number specified is the slower of positive and negative slew rates.

6.7 Electrical Characteristics – $\pm 5\text{-V}$

Unless otherwise specified, all limits are ensured for $T_A = 25^\circ\text{C}$, $V^+ = 5\text{ V}$, $V^- = -5\text{ V}$, $V_{\text{CM}} = 0\text{ V}$, and $R_L > 10\text{ M}\Omega$ to V_{CM} .⁽¹⁾

(1) Electrical table values apply only for factory testing conditions at the temperature indicated. Factory testing conditions result in very limited self-heating of the device.

Electrical Characteristics – ±5-V (continued)

Unless otherwise specified, all limits are ensured for $T_A = 25^\circ\text{C}$, $V^+ = 5\text{ V}$, $V^- = -5\text{ V}$, $V_{\text{CM}} = 0\text{ V}$, and $R_L > 10\text{ M}\Omega$ to V_{CM} .⁽¹⁾

PARAMETER		TEST CONDITIONS		MIN ⁽²⁾	TYP ⁽³⁾	MAX ⁽²⁾	UNIT	
V_{OS}	Input offset voltage			-500	±50	500	μV	
			at the temperature extremes	-800		800		
TCV_{OS}	Input offset voltage drift ⁽⁴⁾				0.25		$\mu\text{V}/^\circ\text{C}$	
			at the temperature extremes		-5	5		
I_{B}	Input bias current ^{(4) (5)}				0.3	10	pA	
			at the temperature extremes			300		
I_{OS}	Input offset current				40		fA	
CMRR	Common-mode rejection ratio LMV841	$-5\text{ V} \leq V_{\text{CM}} \leq 5\text{ V}$			86	112	dB	
				at the temperature extremes	80			
CMRR	Common-mode rejection ratio LMV842 and LMV844	$-5\text{ V} \leq V_{\text{CM}} \leq 5\text{ V}$			86	106	dB	
				at the temperature extremes	80			
PSRR	Power supply rejection ratio	$2.7\text{ V} \leq V^+ \leq 12\text{ V}$, $V_{\text{O}} = 0\text{ V}$			86	108	dB	
				at the temperature extremes	82			
CMVR	Input common-mode voltage range		CMRR $\geq 50\text{ dB}$				V	
A_{VOL}	Large signal voltage gain	$R_L = 2\text{ k}\Omega$ $V_{\text{O}} = -4.7\text{ V to } 4.7\text{ V}$			100	126	dB	
				at the temperature extremes	96			
A_{VOL}	Large signal voltage gain	$R_L = 10\text{ k}\Omega$ $V_{\text{O}} = -4.8\text{ V to } 4.8\text{ V}$			100	136	dB	
				at the temperature extremes	96			
V_{O}	Output swing high, (measured from V^+)	$R_L = 2\text{ k}\Omega$ to 0 V				95	130	mV
				at the temperature extremes			155	
	Output swing low, (measured from V^-)	$R_L = 10\text{ k}\Omega$ to 0 V				44	75	mV
				at the temperature extremes			95	
Output swing low, (measured from V^-)	$R_L = 2\text{ k}\Omega$ to 0 V				105	160	mV	
			at the temperature extremes			200		
Output swing low, (measured from V^-)	$R_L = 10\text{ k}\Omega$ to 0 V				52	80	mV	
			at the temperature extremes			100		
I_{O}	Output short-circuit current ^{(6) (7)}	Sourcing $V_{\text{O}} = 0\text{ V}$ $V_{\text{IN}} = 100\text{ mV}$			20	37	mA	
				at the temperature extremes	15			
Output short-circuit current ^{(6) (7)}	Sinking $V_{\text{O}} = 0\text{ V}$ $V_{\text{IN}} = -100\text{ mV}$			20	29	mA		
			at the temperature extremes	15				

(2) Limits are 100% production tested at 25°C . Limits over the operating temperature range are ensured through correlations using statistical quality control (SQC) method.

(3) Typical values represent the most likely parametric norm as determined at the time of characterization. Actual typical values may vary over time and will also depend on the application and configuration. The typical values are not tested and are not ensured on shipped production material.

(4) This parameter is ensured by design and/or characterization and is not tested in production.

(5) Positive current corresponds to current flowing into the device.

(6) The maximum power dissipation is a function of $T_{\text{J(MAX)}}$, $R_{\theta\text{JA}}$, and T_A . The maximum allowable power dissipation at any ambient temperature is $P_{\text{D}} = (T_{\text{J(MAX)}} - T_A) / R_{\theta\text{JA}}$. All numbers apply for packages soldered directly onto a PCB.

(7) Short circuit test is a momentary test.

Electrical Characteristics – ±5-V (continued)

Unless otherwise specified, all limits are ensured for $T_A = 25^\circ\text{C}$, $V^+ = 5\text{ V}$, $V^- = -5\text{ V}$, $V_{CM} = 0\text{ V}$, and $R_L > 10\text{ M}\Omega$ to V_{CM} .⁽¹⁾

PARAMETER		TEST CONDITIONS	MIN ⁽²⁾	TYP ⁽³⁾	MAX ⁽²⁾	UNIT
I_S	Supply current	Per channel at the temperature extremes	1.03	1.7		mA
					2	
SR	Slew rate ⁽⁸⁾	$A_V = 1$, $V_O = 9\text{ V}_{PP}$ 10% to 90%		2.5		V/ μs
GBW	Gain bandwidth product			4.5		MHz
Φ_m	Phase margin			67		Deg
e_n	Input-referred voltage noise	$f = 1\text{ kHz}$		20		nV/ $\sqrt{\text{Hz}}$
R_{OUT}	Open-loop output impedance	$f = 3\text{ MHz}$		70		Ω
THD+N	Total harmonic distortion + noise	$f = 1\text{ kHz}$, $A_V = 1$ $R_L = 10\text{ k}\Omega$		0.006%		
C_{IN}	Input capacitance			3		pF

(8) Number specified is the slower of positive and negative slew rates.

6.8 Typical Characteristics

At $T_A = 25^\circ\text{C}$, $R_L = 10\text{ k}\Omega$, $V_S = 5\text{ V}$. Unless otherwise specified.

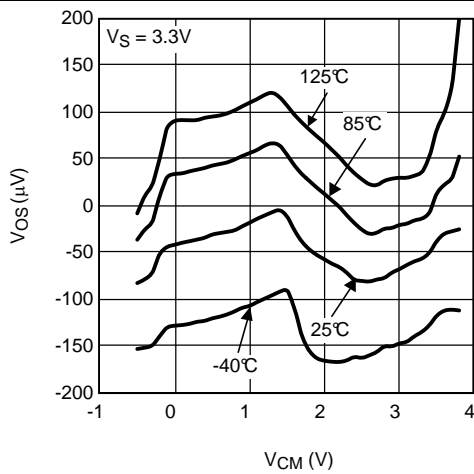

Figure 1. V_{OS} vs V_{CM} Over Temperature at 3.3 V

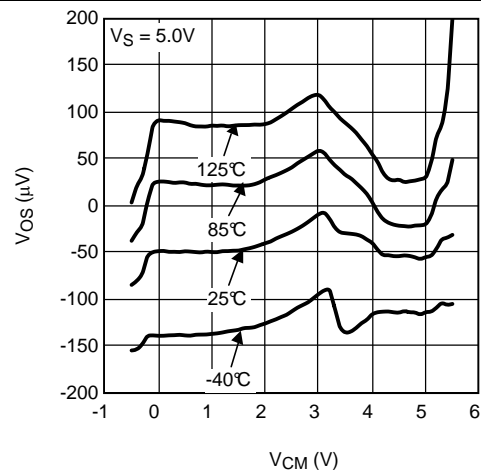

Figure 2. V_{OS} vs V_{CM} Over Temperature at 5 V

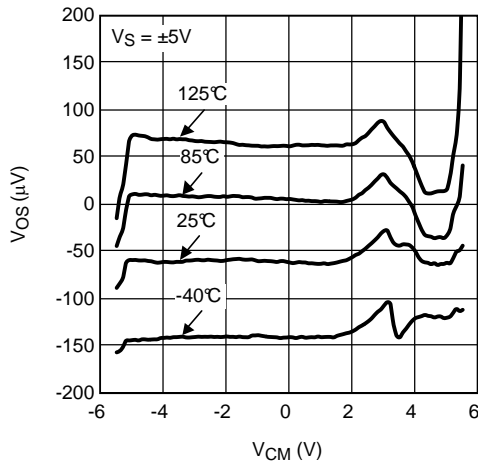

Figure 3. V_{OS} vs V_{CM} Over Temperature at $\pm 5\text{ V}$

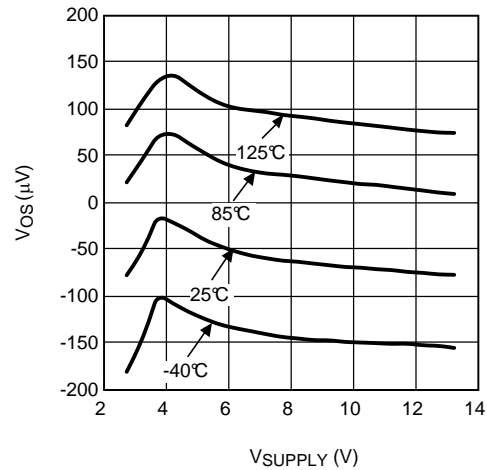

Figure 4. V_{OS} vs Supply Voltage

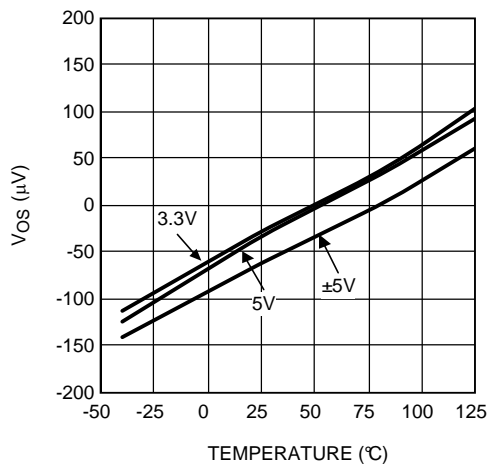

Figure 5. V_{OS} vs Temperature

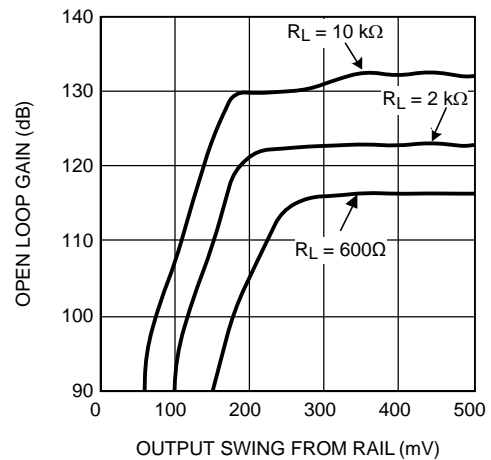

Figure 6. DC Gain vs V_{OUT}

Typical Characteristics (continued)

At $T_A = 25^\circ\text{C}$, $R_L = 10\text{ k}\Omega$, $V_S = 5\text{ V}$. Unless otherwise specified.

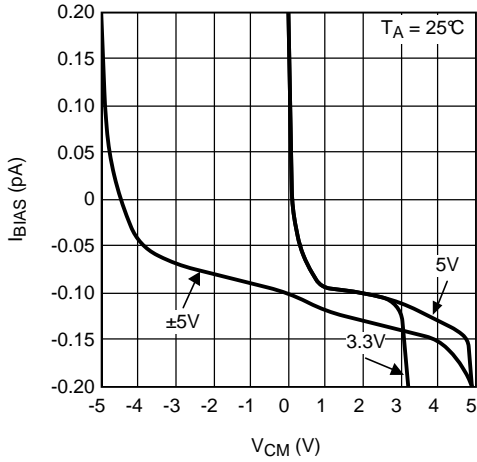

Figure 7. Input Bias Current vs V_{CM}

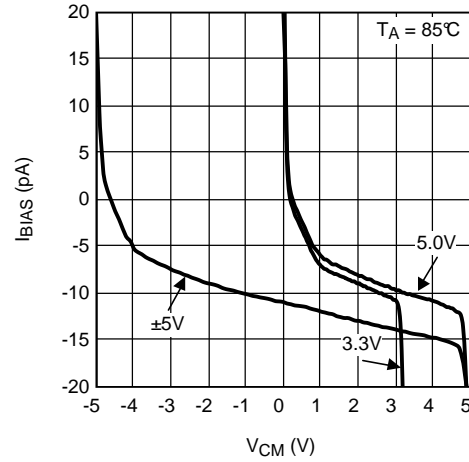

Figure 8. Input Bias Current vs V_{CM}

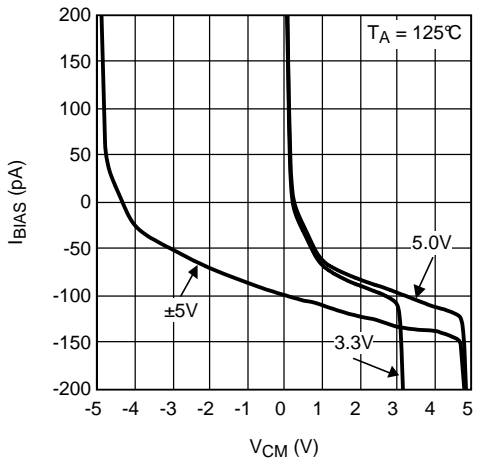

Figure 9. Input Bias Current vs V_{CM}

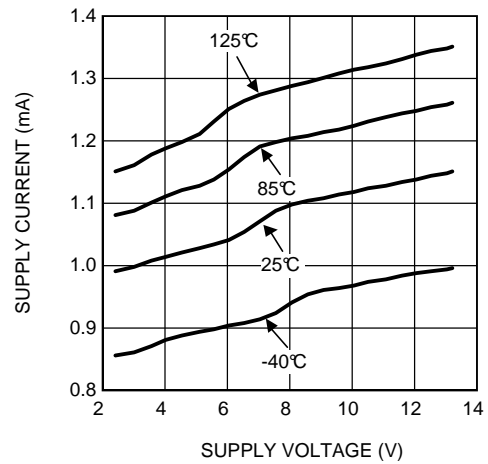

Figure 10. Supply Current Per Channel vs Supply Voltage

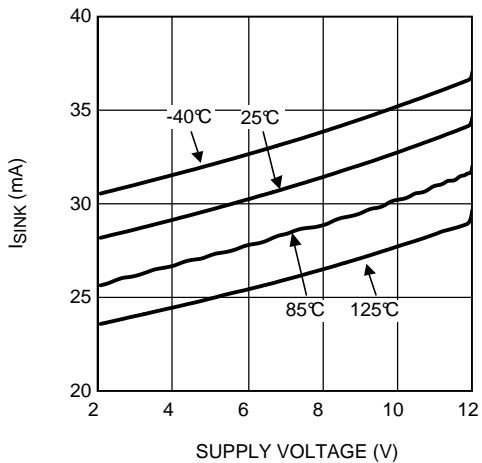

Figure 11. Sinking Current vs Supply Voltage

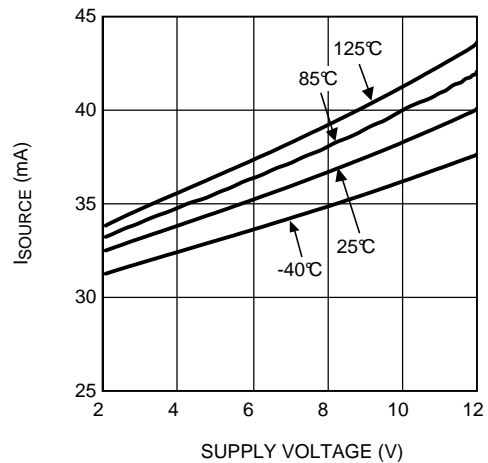

Figure 12. Sourcing Current vs Supply Voltage

Typical Characteristics (continued)

At $T_A = 25^\circ\text{C}$, $R_L = 10\text{ k}\Omega$, $V_S = 5\text{ V}$. Unless otherwise specified.

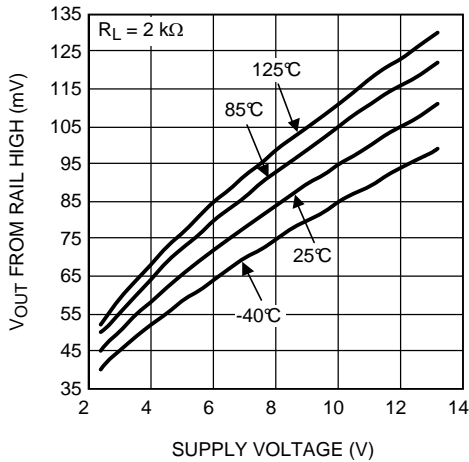

Figure 13. Output Swing High vs Supply Voltage $R_L = 2\text{ k}\Omega$

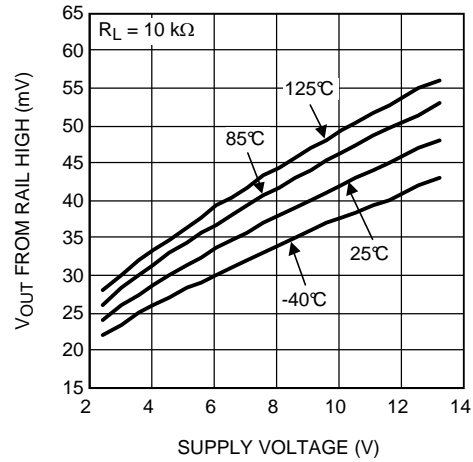

Figure 14. Output Swing High vs Supply Voltage $R_L = 10\text{ k}\Omega$

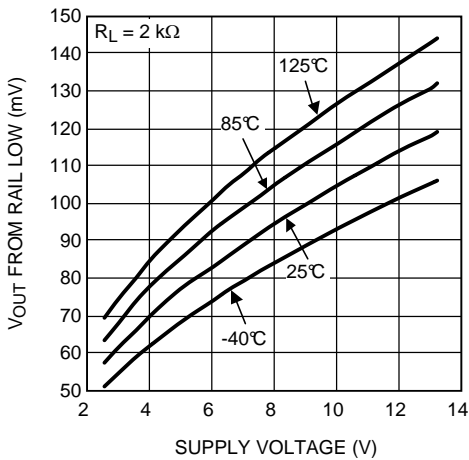

Figure 15. Output Swing Low vs Supply Voltage $R_L = 2\text{ k}\Omega$

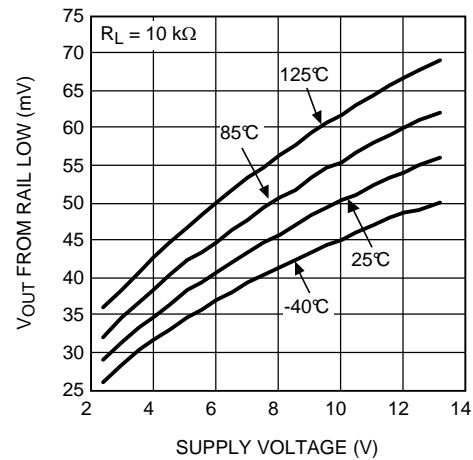

Figure 16. Output Swing Low vs Supply Voltage $R_L = 10\text{ k}\Omega$

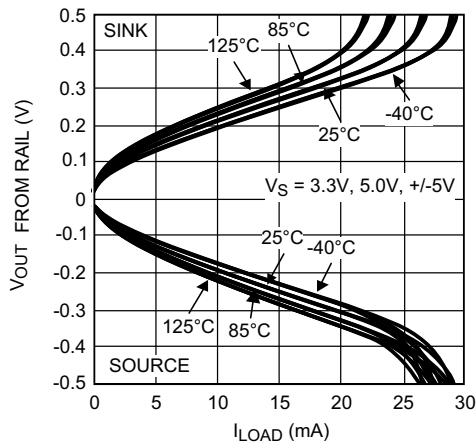

Figure 17. Output Voltage Swing vs Load Current

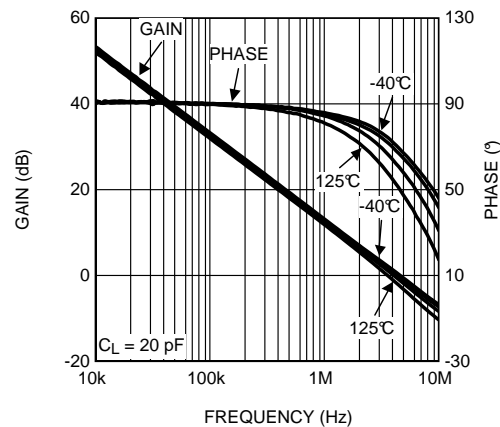

Figure 18. Open-Loop Frequency Response Over Temperature

Typical Characteristics (continued)

At $T_A = 25^\circ\text{C}$, $R_L = 10\text{ k}\Omega$, $V_S = 5\text{ V}$. Unless otherwise specified.

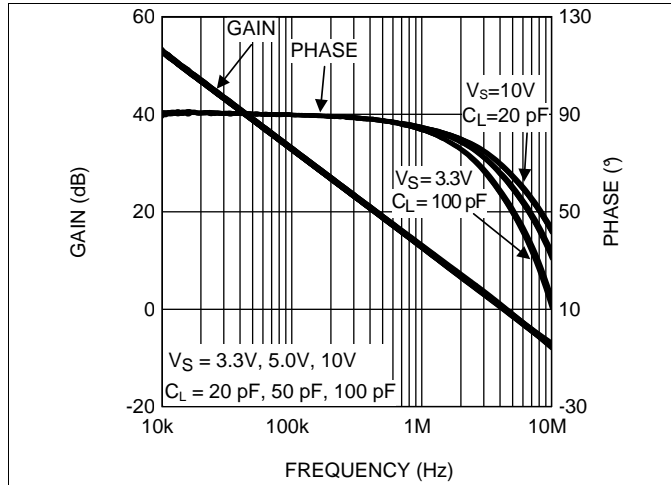

Figure 19. Open-Loop Frequency Response Over Load Conditions

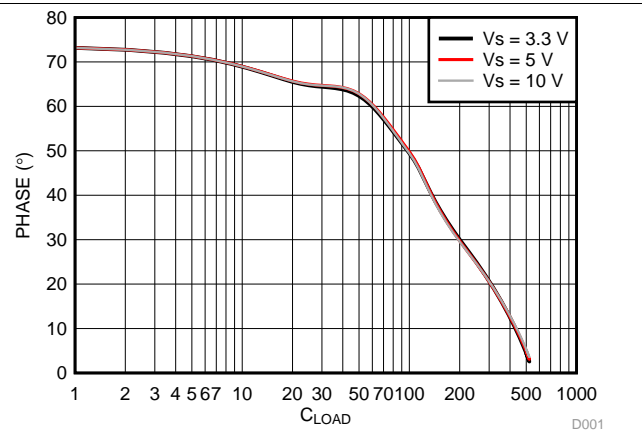

Figure 20. Phase Margin vs C_L

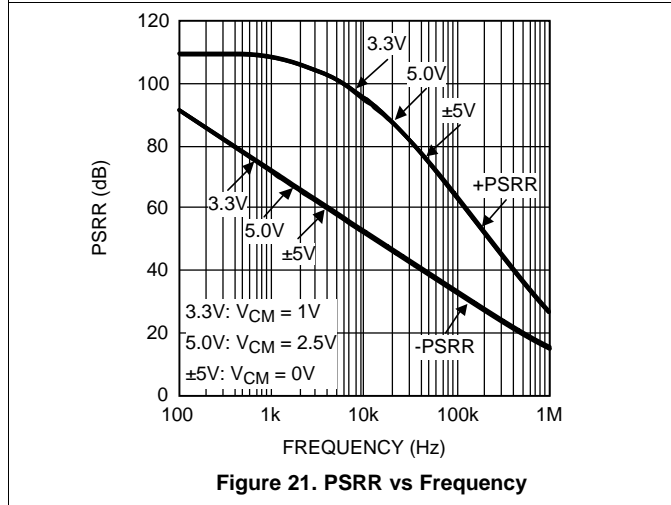

Figure 21. PSRR vs Frequency

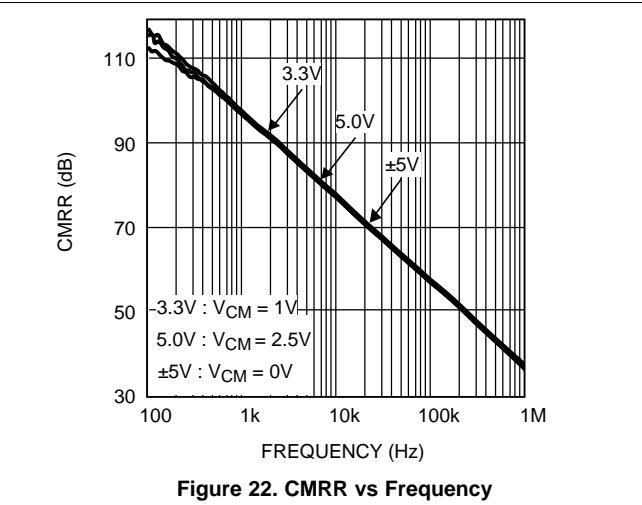

Figure 22. CMRR vs Frequency

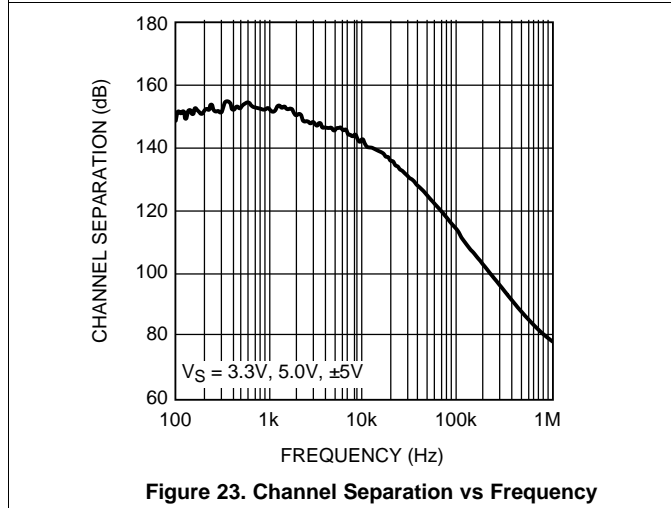

Figure 23. Channel Separation vs Frequency

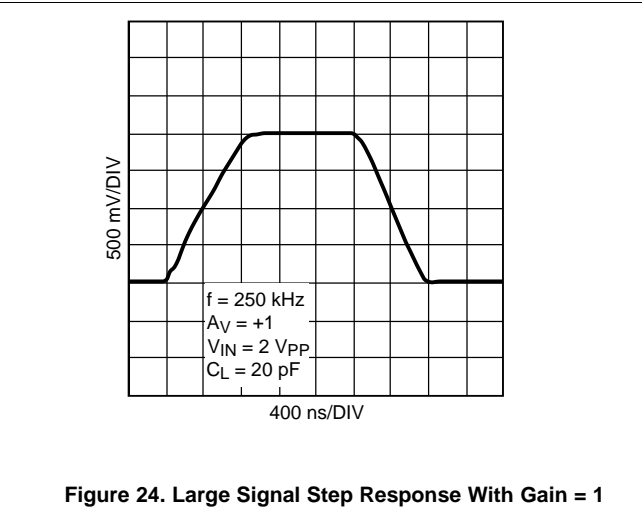

Figure 24. Large Signal Step Response With Gain = 1

Typical Characteristics (continued)

At $T_A = 25^\circ\text{C}$, $R_L = 10\text{ k}\Omega$, $V_S = 5\text{ V}$. Unless otherwise specified.

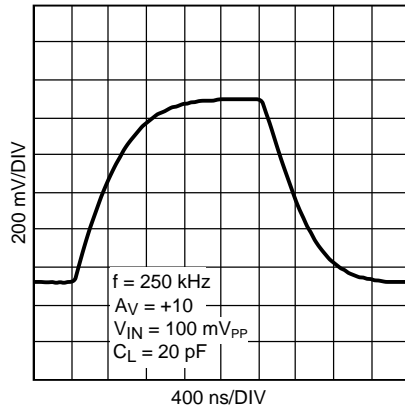

Figure 25. Large Signal Step Response With Gain = 10

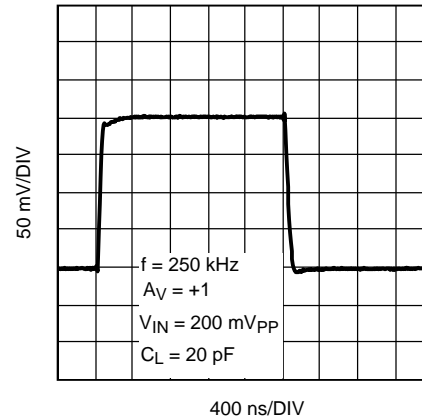

Figure 26. Small Signal Step Response With Gain = 1

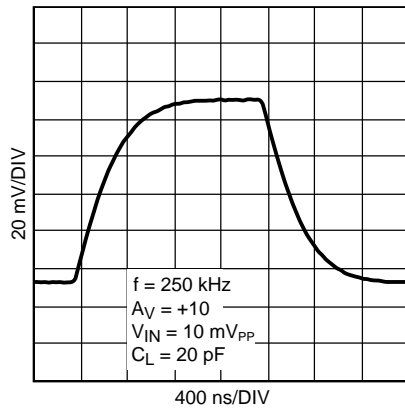

Figure 27. Small Signal Step Response With Gain = 10

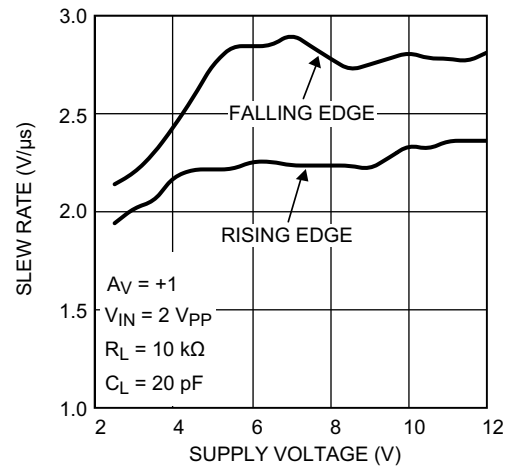

Figure 28. Slew Rate vs Supply Voltage

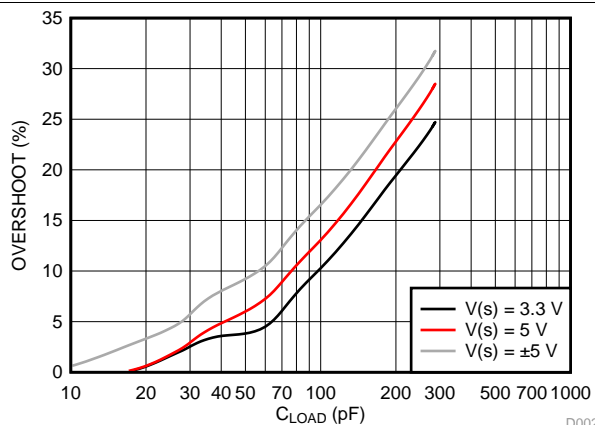

Figure 29. Overshoot vs C_L

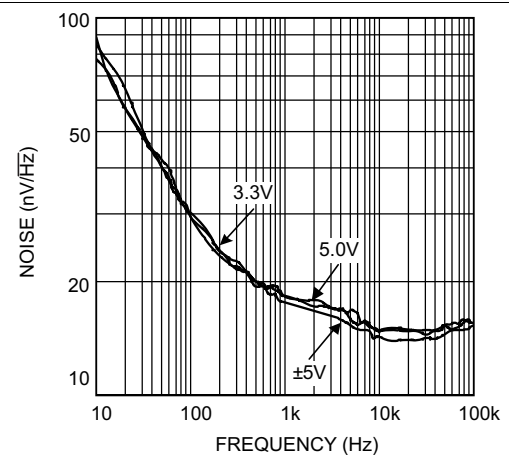

Figure 30. Input Voltage Noise vs Frequency

Typical Characteristics (continued)

At $T_A = 25^\circ\text{C}$, $R_L = 10\text{ k}\Omega$, $V_S = 5\text{ V}$. Unless otherwise specified.

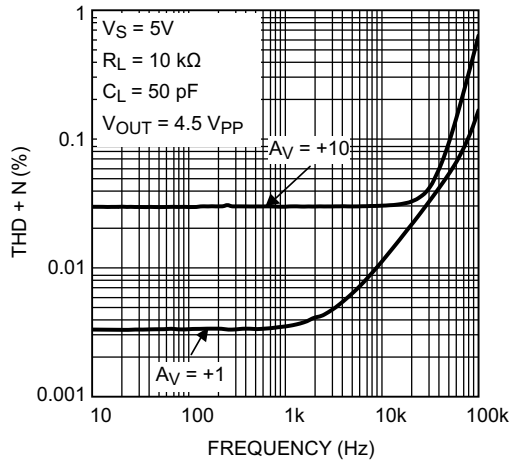

Figure 31. THD+N vs Frequency

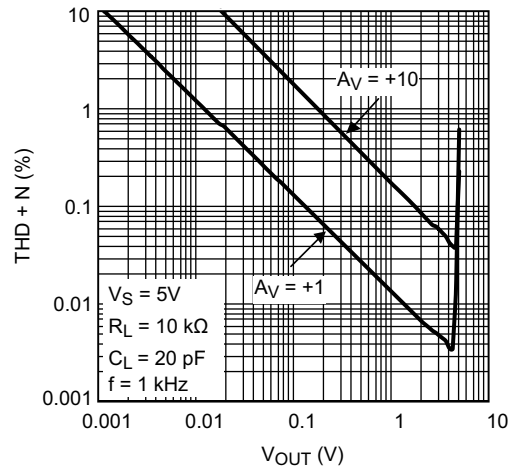

Figure 32. THD+N vs V_{OUT}

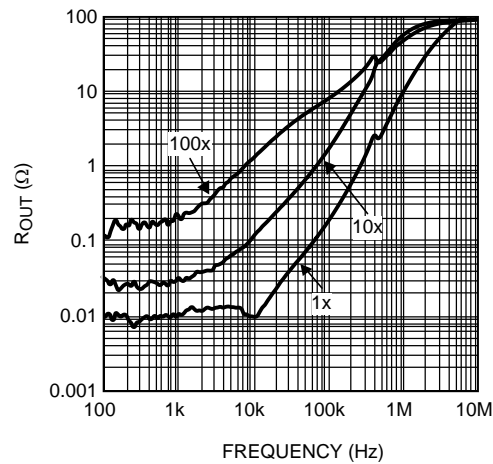

Figure 33. Closed-Loop Output Impedance vs Frequency

7 Detailed Description

7.1 Overview

The LMV84x devices are operational amplifiers with near-precision specifications: low noise, low temperature drift, low offset, and rail-to-rail input and output. Possible application areas include instrumentation, medical, test equipment, audio, and automotive applications.

Its low supply current of 1 mA per amplifier, temperature range of -40°C to $+125^{\circ}\text{C}$, 12-V supply with CMOS input, and the small SC70 package for the LMV841 make the LMV84x a unique op amp family and a perfect choice for portable electronics.

7.2 Functional Block Diagram

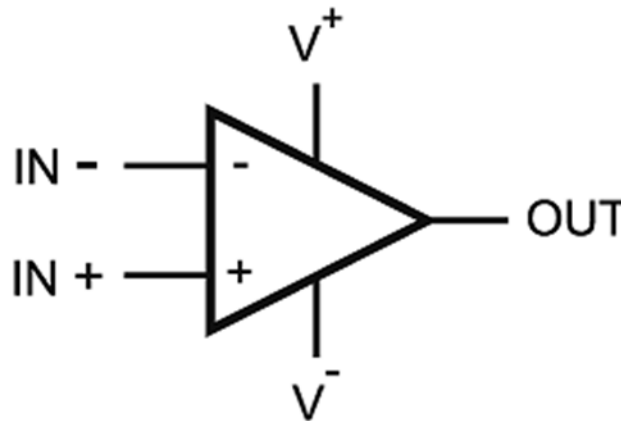

Copyright © 2016, Texas Instruments Incorporated

7.3 Feature Description

7.3.1 Input Protection

The LMV84x devices have a set of anti-parallel diodes D_1 and D_2 between the input pins, as shown in [Figure 34](#). These diodes are present to protect the input stage of the amplifier. At the same time, they limit the amount of differential input voltage that is allowed on the input pins.

A differential signal larger than one diode voltage drop can damage the diodes. The differential signal between the inputs needs to be limited to ± 300 mV or the input current needs to be limited to ± 10 mA.

NOTE

When the op amp is slewing, a differential input voltage exists that forward-biases the protection diodes. This may result in current being drawn from the signal source. While this current is already limited by the internal resistors R_1 and R_2 (both $130\ \Omega$), a resistor of $1\ \text{k}\Omega$ can be placed in the feedback path, or a $500\text{-}\Omega$ resistor can be placed in series with the input signal for further limitation.

Feature Description (continued)

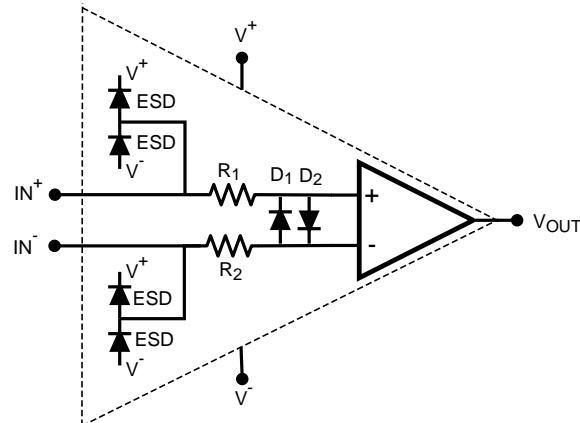

Figure 34. Protection Diodes Between the Input Pins

7.3.2 Input Stage

The input stage of this amplifier consists of both a PMOS and an NMOS input pair to achieve a rail-to-rail input range. For input voltages close to the negative rail, only the PMOS pair is active. Close to the positive rail, only the NMOS pair is active. In a transition region that extends from approximately 2 V below V^+ to 1 V below V^+ , both pairs are active, and one pair gradually takes over from the other. In this transition region, the input-referred offset voltage changes from the offset voltage associated with the PMOS pair to that of the NMOS pair. The input pairs are trimmed independently to ensure an input offset voltage of less than 0.5 mV at room temperature over the complete rail-to-rail input range. This also significantly improves the CMRR of the amplifier in the transition region.

NOTE

The CMRR and PSRR limits in the tables are large-signal numbers that express the maximum variation of the input offset of the amplifier over the full common-mode voltage and supply voltage range, respectively. When the common-mode input voltage of the amplifier is within the transition region, the small signal CMRR and PSRR may be slightly lower than the large signal limits.

7.4 Device Functional Modes

7.4.1 Driving Capacitive Load

The LMV84x can be connected as noninverting unity gain amplifiers. This configuration is the most sensitive to capacitive loading. The combination of a capacitive load placed on the output of an amplifier along with the output impedance of the amplifier creates a phase lag, which reduces the phase margin of the amplifier. If the phase margin is significantly reduced, the response is under-damped, which causes peaking in the transfer. When there is too much peaking, the op amp might start oscillating.

The LMV84x can directly drive capacitive loads up to 100 pF without any stability issues. To drive heavier capacitive loads, an isolation resistor (R_{ISO}) must be used, as shown in Figure 35. By using this isolation resistor, the capacitive load is isolated from the output of the amplifier, and hence, the pole caused by C_L is no longer in the feedback loop. The larger the value of R_{ISO} , the more stable the output voltage is. If values of R_{ISO} are sufficiently large, the feedback loop is stable, independent of the value of C_L . However, larger values of R_{ISO} result in reduced output swing and reduced output current drive.

Device Functional Modes (continued)

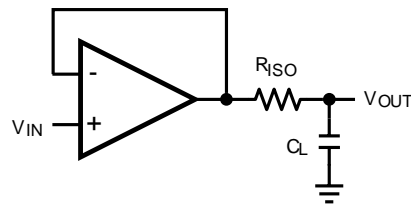

Figure 35. Isolating Capacitive Load

7.4.2 Noise Performance

The LMV84x devices have good noise specifications and are frequently used in low-noise applications. Therefore it is important to determine the noise of the total circuit. Besides the input-referred noise of the op amp, the feedback resistors may have an important contribution to the total noise.

For applications with a voltage input configuration, in general it is beneficial to keep the resistor values low. In these configurations high resistor values mean high noise levels. However, using low resistor values will increase the power consumption of the application. This is not always acceptable for portable applications, so there is a trade-off between noise level and power consumption.

Besides the noise contribution of the signal source, three types of noise need to be taken into account for calculating the noise performance of an op amp circuit:

- Input-referred voltage noise of the op amp
- Input-referred current noise of the op amp
- Noise sources of the resistors in the feedback network, configuring the op amp

To calculate the noise voltage at the output of the op amp, the first step is to determine a total equivalent noise source. This requires the transformation of all noise sources to the same reference node. A convenient choice for this node is the input of the op amp circuit. The next step is to add all the noise sources. The final step is to multiply the total equivalent input voltage noise with the gain of the op amp configuration.

If the input-referred voltage noise of the op amp is already placed at the input, the user can use the input-referred voltage noise without further transferring. The input-referred current noise needs to be converted to an input-referred voltage noise. The current noise is negligibly small, as long as the equivalent resistance is not unrealistically large, so the user can leave the current noise out for these examples. That leaves the user with the noise sources of the resistors, being the thermal noise voltage. The influence of the resistors on the total noise can be seen in the following examples, one with high resistor values and one with low resistor values. Both examples describe an op amp configuration with a gain of 101 which gives the circuit a bandwidth of 44.5 kHz. The op amp noise is the same for both cases, that is, an input-referred noise voltage of $20 \text{ nV}/\sqrt{\text{Hz}}$ and a negligibly small input-referred noise current.

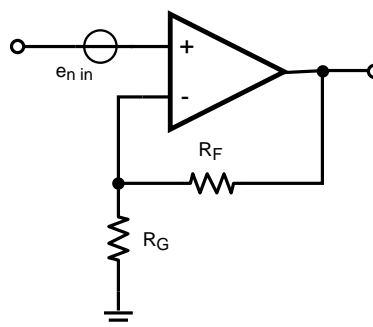

Figure 36. Noise Circuit

Device Functional Modes (continued)

To calculate the noise of the resistors in the feedback network, the equivalent input-referred noise resistance is needed. For the example in [Figure 36](#), this equivalent resistance R_{eq} can be calculated using [Equation 1](#):

$$R_{eq} = \frac{R_F \times R_G}{R_F + R_G} \quad (1)$$

The voltage noise of the equivalent resistance can be calculated using [Equation 2](#):

$$e_{nr} = \sqrt{4kTR_{eq}}$$

where

- e_{nr} = thermal noise voltage of the equivalent resistor
 - R_{eq} (V/ \sqrt{Hz})
 - k = Boltzmann constant (1.38×10^{-23} J/K)
 - T = absolute temperature (K)
 - R_{eq} = resistance (Ω)
- (2)

The total equivalent input voltage noise is given by [Equation 3](#):

$$e_{n\ in} = \sqrt{e_{nv}^2 + e_{nr}^2}$$

where

- $e_{n\ in}$ = total input equivalent voltage noise of the circuit
 - e_{nv} = input voltage noise of the op amp
- (3)

The final step is multiplying the total input voltage noise by the noise gain using [Equation 4](#), which is in this case the gain of the op amp configuration:

$$e_{n\ out} = e_{n\ in} \times A_{noise} \quad (4)$$

The equivalent resistance for the first example with a resistor R_F of 10 M Ω and a resistor R_G of 100 k Ω at 25°C (298 K) equals [Equation 5](#):

$$R_{eq} = \frac{R_F \times R_G}{R_F + R_G} = \frac{10\ M\Omega \times 100\ k\Omega}{10\ M\Omega + 100\ k\Omega} = 99\ k\Omega \quad (5)$$

Now the noise of the resistors can be calculated using [Equation 6](#), yielding:

$$\begin{aligned} e_{nr} &= \sqrt{4kTR_{eq}} \\ &= \sqrt{4 \times 1.38 \times 10^{-23}\ J/K \times 298\ K \times 99\ k\Omega} \\ &= 40\ nV/\sqrt{Hz} \end{aligned} \quad (6)$$

The total noise at the input of the op amp is calculated in [Equation 7](#):

$$\begin{aligned} e_{n\ in} &= \sqrt{e_{nv}^2 + e_{nr}^2} \\ &= \sqrt{(20\ nV/\sqrt{Hz})^2 + (40\ nV/\sqrt{Hz})^2} = 45\ nV/\sqrt{Hz} \end{aligned} \quad (7)$$

For the first example, this input noise, multiplied with the noise gain, in [Equation 8](#) gives a total output noise of:

$$\begin{aligned} e_{n\ out} &= e_{n\ in} \times A_{noise} \\ &= 45\ nV/\sqrt{Hz} \times 101 = 4.5\ \mu V/\sqrt{Hz} \end{aligned} \quad (8)$$

In the second example, with a resistor R_F of 10 k Ω and a resistor R_G of 100 Ω at 25°C (298 K), the equivalent resistance equals [Equation 9](#):

$$R_{eq} = \frac{R_F \times R_G}{R_F + R_G} = \frac{10\ k\Omega \times 100\ \Omega}{10\ k\Omega + 100\ \Omega} = 99\ \Omega \quad (9)$$

The resistor noise for the second example is calculated in [Equation 10](#):

Device Functional Modes (continued)

$$\begin{aligned}
 e_{nr} &= \sqrt{4kTR_{eq}} \\
 &= \sqrt{4 \times 1.38 \times 10^{-23} \text{ J/K} \times 298 \text{ K} \times 99 \text{ } \Omega} \\
 &= 1 \text{ nV}/\sqrt{\text{Hz}}
 \end{aligned}
 \tag{10}$$

The total noise at the input of the op amp is calculated in [Equation 10](#):

$$\begin{aligned}
 e_{n \text{ in}} &= \sqrt{e_{nv}^2 + e_{nr}^2} \\
 &= \sqrt{(20 \text{ nV}/\sqrt{\text{Hz}})^2 + (1 \text{ nV}/\sqrt{\text{Hz}})^2} \\
 &= 20 \text{ nV}/\sqrt{\text{Hz}}
 \end{aligned}
 \tag{11}$$

For the second example the input noise, multiplied with the noise gain, in [Equation 12](#) gives an output noise of:

$$\begin{aligned}
 e_{n \text{ out}} &= e_{n \text{ in}} \times A_{noise} \\
 &= 20 \text{ nV}/\sqrt{\text{Hz}} \times 101 = 2 \text{ } \mu\text{V}/\sqrt{\text{Hz}}
 \end{aligned}
 \tag{12}$$

In the first example the noise is dominated by the resistor noise due to the very high resistor values, in the second example the very low resistor values add only a negligible contribution to the noise and now the dominating factor is the op amp itself. When selecting the resistor values, it is important to choose values that do not add extra noise to the application. Choosing values above 100 k Ω may increase the noise too much. Low values keep the noise within acceptable levels; choosing very low values however, does not make the noise even lower, but can increase the current of the circuit.

7.5 Interfacing to High Impedance Sensor

With CMOS inputs, the LMV84x are particularly suited to be used as high impedance sensor interfaces.

Many sensors have high source impedances that may range up to 10 M Ω . The input bias current of an amplifier loads the output of the sensor, and thus cause a voltage drop across the source resistance, as shown in [Figure 37](#). When an op amp is selected with a relatively high input bias current, this error may be unacceptable.

The low input current of the LMV84x significantly reduces such errors. The following examples show the difference between a standard op amp input and the CMOS input of the LMV84x.

The voltage at the input of the op amp can be calculated with [Equation 13](#):

$$V_{IN+} = V_S - I_B \times R_S \tag{13}$$

For a standard op amp, the input bias I_B can be 10 nA. When the sensor generates a signal of 1 V (V_S) and the sensors impedance is 10 M Ω (R_S), the signal at the op amp input is calculated in [Equation 14](#):

$$V_{IN} = 1 \text{ V} - 10 \text{ nA} \times 10 \text{ M}\Omega = 1 \text{ V} - 0.1 \text{ V} = 0.9 \text{ V} \tag{14}$$

For the CMOS input of the LMV84x, which has an input bias current of only 0.3 pA, this would give [Equation 15](#):

$$V_{IN} = 1 \text{ V} - 0.3 \text{ pA} \times 10 \text{ M}\Omega = 1 \text{ V} - 3 \text{ } \mu\text{V} = 0.999997 \text{ V} \tag{15}$$

The conclusion is that a standard op amp, with its high input bias current input, is not a good choice for use in impedance sensor applications. The LMV84x devices, in contrast, are much more suitable due to the low input bias current. The error is negligibly small; therefore, the LMV84x are a must for use with high-impedance sensors.

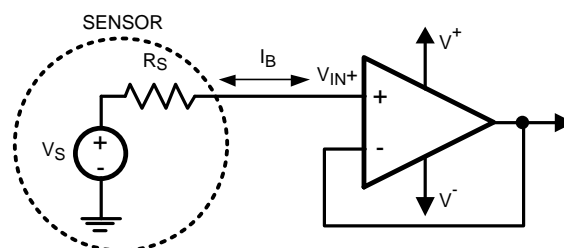

Figure 37. High Impedance Sensor Interface

8 Application and Implementation

NOTE

Information in the following applications sections is not part of the TI component specification, and TI does not warrant its accuracy or completeness. TI's customers are responsible for determining suitability of components for their purposes. Customers should validate and test their design implementation to confirm system functionality.

8.1 Application Information

The rail-to-rail input and output of the LMV84x and the wide supply voltage range make these amplifiers ideal to use in numerous applications. Three sample applications, namely the active filter circuit, high-side current sensing, and thermocouple sensor interface, are provided in the [Typical Applications](#) section.

8.2 Typical Applications

8.2.1 Active Filter Circuit

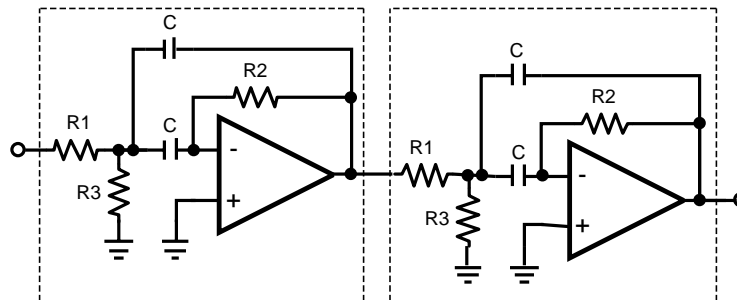

Figure 38. Active Band-Pass Filter Implementation

8.2.1.1 Design Requirements

In this example it is required to design a bandpass filter with band-pass frequency of 10 kHz, and a center frequency of approximately 10% from the total frequency of the filter. This is achieved by cascading two band-pass filters, A and B, with slightly different center frequencies.

8.2.1.2 Detailed Design Procedure

The center frequency of the separate band-pass filters A, and B can be calculated by [Equation 16](#):

$$f_{mid} = \frac{1}{2\pi C} \sqrt{\frac{R_1 + R_3}{R_1 R_2 R_3}}$$

where

- C = 33 nF
- R1 = 2 kΩ
- R2 = 6.2 kΩ
- and R3 = 45 Ω

(16)

This gives [Equation 17](#) for filter A:

$$f_{mid} = \frac{1}{\pi \times 33 \text{ nF}} \sqrt{\frac{2 \text{ k}\Omega + 6.2 \text{ k}\Omega}{2 \text{ k}\Omega \times 6.2 \text{ k}\Omega \times 45 \text{ k}\Omega}} = 9.2 \text{ kHz}$$

(17)

and [Equation 18](#) for filter B with C = 27nF:

$$f_{mid} = \frac{1}{\pi \times 27 \text{ nF}} \sqrt{\frac{2 \text{ k}\Omega + 6.2 \text{ k}\Omega}{2 \text{ k}\Omega \times 6.2 \text{ k}\Omega \times 45 \text{ k}\Omega}} = 11.2 \text{ kHz}$$

(18)

Bandwidth can be calculated by [Equation 19](#):

Typical Applications (continued)

$$B = \frac{1}{\pi R_2 C} \quad (19)$$

For filter A, this gives Equation 20:

$$B = \frac{1}{\pi \times 6.2 \text{ k}\Omega \times 33 \text{ nF}} = 1.6 \text{ kHz} \quad (20)$$

and Equation 21 for filter B:

$$B = \frac{1}{\pi \times 6.2 \text{ k}\Omega \times 27 \text{ nF}} = 1.9 \text{ kHz} \quad (21)$$

8.2.1.3 Application Curve

The responses of filter A and filter B are shown as the thin lines in Figure 39; the response of the combined filter is shown as the thick line. Shifting the center frequencies of the separate filters farther apart, results in a wider band; however, positioning the center frequencies too far apart results in a less flat gain within the band. For wider bands more band-pass filters can be cascaded.

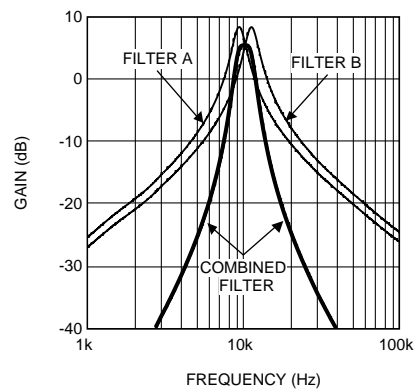

Figure 39. Active Band-Pass Filter Curve

NOTE

Use the WEBENCH internet tools at www.ti.com for your filter application.

8.2.2 High-Side, Current-Sensing Circuit

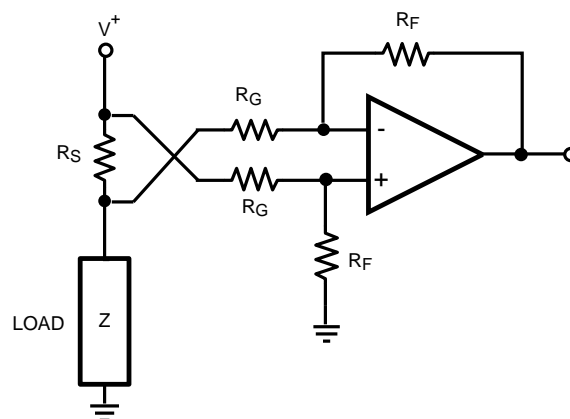

Figure 40. High-Side, Current-Sensing Circuit

Typical Applications (continued)

A K-type thermocouple has a wide temperature range. The range of this thermocouple is from approximately -200°C to approximately 1200°C , as can be seen in Figure 42. This covers the generally used temperature ranges.

Over the main part of the range the behavior is linear. This is important for converting the analog signal to a digital signal. The K-type thermocouple has good sensitivity when compared to many other types; the sensitivity is $41\ \mu\text{V}/^{\circ}\text{C}$. Lower sensitivity requires more gain and makes the application more sensitive to noise. In addition, a K-type thermocouple is not expensive, many other thermocouples consist of more expensive materials or are more difficult to produce.

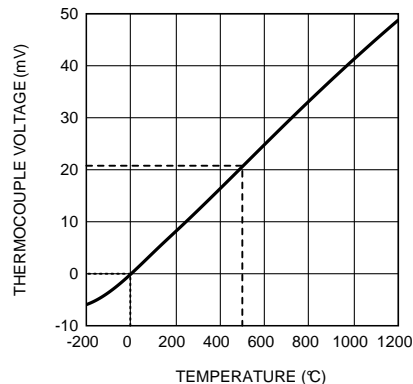

Figure 42. K-Type Thermocouple Response

The temperature range of 0°C to 500°C results in a voltage range from 0 mV to 20.6 mV produced by the thermocouple. This is shown in Figure 42.

To obtain the best accuracy the full ADC range of 0 to 3.3 V is used and the gain needed for this full range can be calculated Equation 23:

$$A_V = 3.3\ \text{V} / 0.0206\ \text{V} = 160 \quad (23)$$

If R_G is 2 k Ω , then the value for R_F can be calculated with this gain of 160. Because $A_V = R_F / R_G$, R_F can be calculated in Equation 24:

$$R_F = A_V \times R_G = 160 \times 2\ \text{k}\Omega = 320\ \text{k}\Omega \quad (24)$$

To achieve a resolution of 0.5°C a step smaller than the minimum resolution is needed. This means that at least 1000 steps are necessary ($500^{\circ}\text{C}/0.5^{\circ}\text{C}$). A 10-bit ADC would be sufficient as this gives 1024 steps. A 10-bit ADC such as the two channel 10-bit ADC102S021 would be a good choice.

At the point where the thermocouple wires are connected to the circuit on the PCB unwanted parasitic thermocouple is formed, introducing error in the measurements of the actual thermocouple sensor.

Using an isothermal block as a reference will compensate for this additional thermocouple effect. An isothermal block is a good heat conductor. This means that the two thermocouple connections both have the same temperature. The temperature of the isothermal block can be measured, and thereby the temperature of the thermocouple connections. This is usually called the cold junction reference temperature. In the example, an LM35 is used to measure this temperature. This semiconductor temperature sensor can accurately measure temperatures from -55°C to 150°C .

The ADC in this example also converts the signal from the LM35 to a digital signal, hence, the microprocessor can compensate for the amplified thermocouple signal of the unwanted thermocouple junction at the connector.

9 Power Supply Recommendations

The LMV84x is specified for operation from 2.7 V to 12 V (± 1.35 V to ± 6 V) over a -40°C to 125°C temperature range. Parameters that can exhibit significant variance with regard to operating voltage or temperature are presented in the [Absolute Maximum Ratings](#).

CAUTION

Supply voltages larger than 13.2 V can permanently damage the device.

For proper operation, the power supplies must be properly decoupled. For decoupling the supply lines, TI suggests placing 10-nF capacitors as close as possible to the operational amplifier power supply pins. For single supply, place a capacitor between V^+ and V^- supply leads. For dual supplies, place one capacitor between V^+ and ground, and one capacitor between V^- and ground.

10 Layout

10.1 Layout Guidelines

- The V^+ pin must be bypassed to ground with a low-ESR capacitor.
- The optimum placement is closest to the V^+ and ground pins.
- Take care to minimize the loop area formed by the bypass capacitor connection between V^+ and ground.
- The ground pin must be connected to the PCB ground plane at the pin of the device.
- The feedback components must be placed as close to the device as possible to minimize strays.

10.2 Layout Example

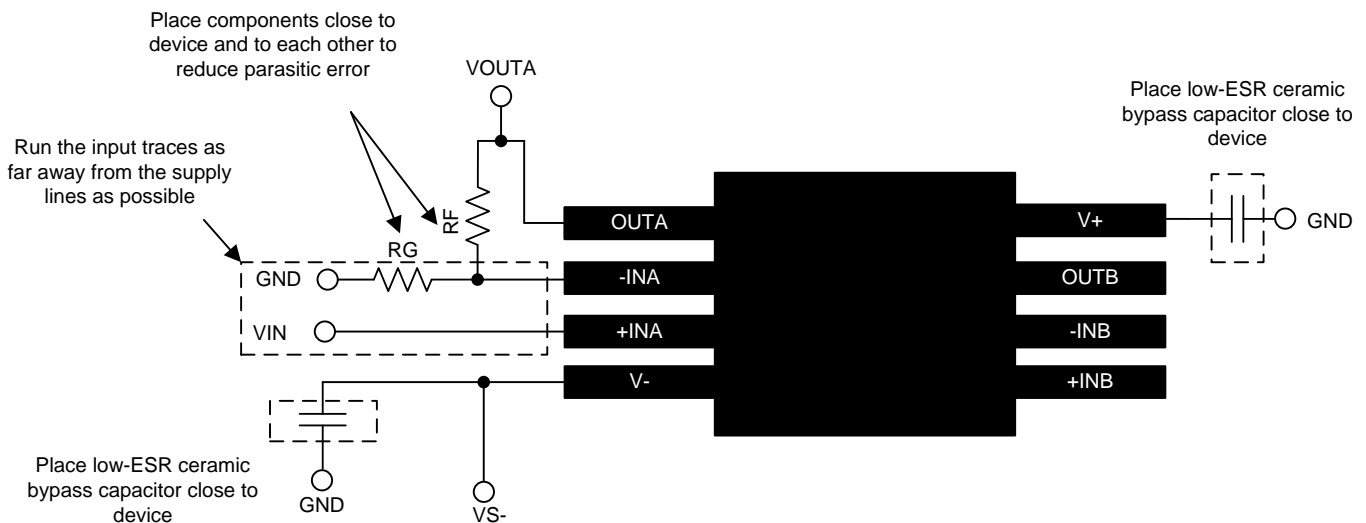

Figure 43. Layout Example (Top View)

11 Device and Documentation Support

11.1 Related Links

The table below lists quick access links. Categories include technical documents, support and community resources, tools and software, and quick access to order now.

Table 1. Related Links

PARTS	PRODUCT FOLDER	ORDER NOW	TECHNICAL DOCUMENTS	TOOLS & SOFTWARE	SUPPORT & COMMUNITY
LMV841	Click here	Click here	Click here	Click here	Click here
LMV842	Click here	Click here	Click here	Click here	Click here
LMV844	Click here	Click here	Click here	Click here	Click here

11.2 Receiving Notification of Documentation Updates

To receive notification of documentation updates, navigate to the device product folder on ti.com. In the upper right corner, click on *Alert me* to register and receive a weekly digest of any product information that has changed. For change details, review the revision history included in any revised document.

11.3 Community Resources

The following links connect to TI community resources. Linked contents are provided "AS IS" by the respective contributors. They do not constitute TI specifications and do not necessarily reflect TI's views; see TI's [Terms of Use](#).

TI E2E™ Online Community *TI's Engineer-to-Engineer (E2E) Community*. Created to foster collaboration among engineers. At e2e.ti.com, you can ask questions, share knowledge, explore ideas and help solve problems with fellow engineers.

Design Support *TI's Design Support* Quickly find helpful E2E forums along with design support tools and contact information for technical support.

11.4 Trademarks

E2E is a trademark of Texas Instruments.
All other trademarks are the property of their respective owners.

11.5 Electrostatic Discharge Caution



These devices have limited built-in ESD protection. The leads should be shorted together or the device placed in conductive foam during storage or handling to prevent electrostatic damage to the MOS gates.

11.6 Glossary

[SLYZ022](#) — *TI Glossary*.

This glossary lists and explains terms, acronyms, and definitions.

12 Mechanical, Packaging, and Orderable Information

The following pages include mechanical, packaging, and orderable information. This information is the most current data available for the designated devices. This data is subject to change without notice and revision of this document. For browser-based versions of this data sheet, refer to the left-hand navigation.

PACKAGING INFORMATION

Orderable Device	Status (1)	Package Type	Package Drawing	Pins	Package Qty	Eco Plan (2)	Lead/Ball Finish (6)	MSL Peak Temp (3)	Op Temp (°C)	Device Marking (4/5)	Samples
LMV841MG/NOPB	ACTIVE	SC70	DCK	5	1000	Green (RoHS & no Sb/Br)	CU SN	Level-1-260C-UNLIM	-40 to 125	A97	Samples
LMV841MGX/NOPB	ACTIVE	SC70	DCK	5	3000	Green (RoHS & no Sb/Br)	CU SN	Level-1-260C-UNLIM	-40 to 125	A97	Samples
LMV842MA/NOPB	ACTIVE	SOIC	D	8	95	Green (RoHS & no Sb/Br)	CU SN	Level-1-260C-UNLIM	-40 to 125	LMV84 2MA	Samples
LMV842MAX/NOPB	ACTIVE	SOIC	D	8	2500	Green (RoHS & no Sb/Br)	CU SN	Level-1-260C-UNLIM	-40 to 125	LMV84 2MA	Samples
LMV842MM/NOPB	ACTIVE	VSSOP	DGK	8	1000	Green (RoHS & no Sb/Br)	CU NIPDAUAG CU SN	Level-1-260C-UNLIM	-40 to 125	AC4A	Samples
LMV842MMX/NOPB	ACTIVE	VSSOP	DGK	8	3500	Green (RoHS & no Sb/Br)	CU NIPDAUAG CU SN	Level-1-260C-UNLIM	-40 to 125	AC4A	Samples
LMV844MA/NOPB	ACTIVE	SOIC	D	14	55	Green (RoHS & no Sb/Br)	CU SN Call TI	Level-1-260C-UNLIM	-40 to 125	LMV844MA	Samples
LMV844MAX/NOPB	ACTIVE	SOIC	D	14	2500	Green (RoHS & no Sb/Br)	CU SN Call TI	Level-1-260C-UNLIM	-40 to 125	LMV844MA	Samples
LMV844MT/NOPB	ACTIVE	TSSOP	PW	14	94	Green (RoHS & no Sb/Br)	CU SN	Level-1-260C-UNLIM	-40 to 125	LMV844 MT	Samples
LMV844MTX/NOPB	ACTIVE	TSSOP	PW	14	2500	Green (RoHS & no Sb/Br)	CU SN	Level-1-260C-UNLIM	-40 to 125	LMV844 MT	Samples

(1) The marketing status values are defined as follows:

ACTIVE: Product device recommended for new designs.

LIFEBUY: TI has announced that the device will be discontinued, and a lifetime-buy period is in effect.

NRND: Not recommended for new designs. Device is in production to support existing customers, but TI does not recommend using this part in a new design.

PREVIEW: Device has been announced but is not in production. Samples may or may not be available.

OBSOLETE: TI has discontinued the production of the device.

(2) **RoHS:** TI defines "RoHS" to mean semiconductor products that are compliant with the current EU RoHS requirements for all 10 RoHS substances, including the requirement that RoHS substance do not exceed 0.1% by weight in homogeneous materials. Where designed to be soldered at high temperatures, "RoHS" products are suitable for use in specified lead-free processes. TI may reference these types of products as "Pb-Free".

RoHS Exempt: TI defines "RoHS Exempt" to mean products that contain lead but are compliant with EU RoHS pursuant to a specific EU RoHS exemption.

Green: TI defines "Green" to mean the content of Chlorine (Cl) and Bromine (Br) based flame retardants meet JS709B low halogen requirements of <=1000ppm threshold. Antimony trioxide based flame retardants must also meet the <=1000ppm threshold requirement.

(3) MSL, Peak Temp. - The Moisture Sensitivity Level rating according to the JEDEC industry standard classifications, and peak solder temperature.

(4) There may be additional marking, which relates to the logo, the lot trace code information, or the environmental category on the device.

(5) Multiple Device Markings will be inside parentheses. Only one Device Marking contained in parentheses and separated by a "~" will appear on a device. If a line is indented then it is a continuation of the previous line and the two combined represent the entire Device Marking for that device.

(6) Lead/Ball Finish - Orderable Devices may have multiple material finish options. Finish options are separated by a vertical ruled line. Lead/Ball Finish values may wrap to two lines if the finish value exceeds the maximum column width.

Important Information and Disclaimer:The information provided on this page represents TI's knowledge and belief as of the date that it is provided. TI bases its knowledge and belief on information provided by third parties, and makes no representation or warranty as to the accuracy of such information. Efforts are underway to better integrate information from third parties. TI has taken and continues to take reasonable steps to provide representative and accurate information but may not have conducted destructive testing or chemical analysis on incoming materials and chemicals. TI and TI suppliers consider certain information to be proprietary, and thus CAS numbers and other limited information may not be available for release.

In no event shall TI's liability arising out of such information exceed the total purchase price of the TI part(s) at issue in this document sold by TI to Customer on an annual basis.

OTHER QUALIFIED VERSIONS OF LMV841, LMV842, LMV844 :

- Automotive: [LMV841-Q1](#), [LMV842-Q1](#), [LMV844-Q1](#)

NOTE: Qualified Version Definitions:

- Automotive - Q100 devices qualified for high-reliability automotive applications targeting zero defects

TAPE AND REEL INFORMATION

QUADRANT ASSIGNMENTS FOR PIN 1 ORIENTATION IN TAPE

*All dimensions are nominal

Device	Package Type	Package Drawing	Pins	SPQ	Reel Diameter (mm)	Reel Width W1 (mm)	A0 (mm)	B0 (mm)	K0 (mm)	P1 (mm)	W (mm)	Pin1 Quadrant
LMV841MG/NOPB	SC70	DCK	5	1000	178.0	8.4	2.25	2.45	1.2	4.0	8.0	Q3
LMV841MGX/NOPB	SC70	DCK	5	3000	178.0	8.4	2.25	2.45	1.2	4.0	8.0	Q3
LMV842MAX/NOPB	SOIC	D	8	2500	330.0	12.4	6.5	5.4	2.0	8.0	12.0	Q1
LMV842MM/NOPB	VSSOP	DGK	8	1000	178.0	12.4	5.3	3.4	1.4	8.0	12.0	Q1
LMV842MMX/NOPB	VSSOP	DGK	8	3500	330.0	12.4	5.3	3.4	1.4	8.0	12.0	Q1
LMV844MAX/NOPB	SOIC	D	14	2500	330.0	16.4	6.5	9.35	2.3	8.0	16.0	Q1
LMV844MTX/NOPB	TSSOP	PW	14	2500	330.0	12.4	6.95	5.6	1.6	8.0	12.0	Q1

TAPE AND REEL BOX DIMENSIONS

*All dimensions are nominal

Device	Package Type	Package Drawing	Pins	SPQ	Length (mm)	Width (mm)	Height (mm)
LMV841MG/NOPB	SC70	DCK	5	1000	210.0	185.0	35.0
LMV841MGX/NOPB	SC70	DCK	5	3000	210.0	185.0	35.0
LMV842MAX/NOPB	SOIC	D	8	2500	367.0	367.0	35.0
LMV842MM/NOPB	VSSOP	DGK	8	1000	210.0	185.0	35.0
LMV842MMX/NOPB	VSSOP	DGK	8	3500	367.0	367.0	35.0
LMV844MAX/NOPB	SOIC	D	14	2500	367.0	367.0	35.0
LMV844MTX/NOPB	TSSOP	PW	14	2500	367.0	367.0	35.0

DCK (R-PDSO-G5)

PLASTIC SMALL-OUTLINE PACKAGE



- NOTES:
- A. All linear dimensions are in millimeters.
 - B. This drawing is subject to change without notice.
 - C. Body dimensions do not include mold flash or protrusion. Mold flash and protrusion shall not exceed 0.15 per side.
 - D. Falls within JEDEC MO-203 variation AA.

DCK (R-PDSO-G5)

PLASTIC SMALL OUTLINE



- NOTES:
- All linear dimensions are in millimeters.
 - This drawing is subject to change without notice.
 - Customers should place a note on the circuit board fabrication drawing not to alter the center solder mask defined pad.
 - Publication IPC-7351 is recommended for alternate designs.
 - Laser cutting apertures with trapezoidal walls and also rounding corners will offer better paste release. Customers should contact their board assembly site for stencil design recommendations. Example stencil design based on a 50% volumetric metal load solder paste. Refer to IPC-7525 for other stencil recommendations.

D (R-PDSO-G14)

PLASTIC SMALL OUTLINE



- NOTES:
- A. All linear dimensions are in inches (millimeters).
 - B. This drawing is subject to change without notice.
 -  Body length does not include mold flash, protrusions, or gate burrs. Mold flash, protrusions, or gate burrs shall not exceed 0.006 (0,15) each side.
 -  Body width does not include interlead flash. Interlead flash shall not exceed 0.017 (0,43) each side.
 - E. Reference JEDEC MS-012 variation AB.

D (R-PDSO-G14)

PLASTIC SMALL OUTLINE



- NOTES:
- A. All linear dimensions are in millimeters.
 - B. This drawing is subject to change without notice.
 - C. Publication IPC-7351 is recommended for alternate designs.
 - D. Laser cutting apertures with trapezoidal walls and also rounding corners will offer better paste release. Customers should contact their board assembly site for stencil design recommendations. Refer to IPC-7525 for other stencil recommendations.
 - E. Customers should contact their board fabrication site for solder mask tolerances between and around signal pads.

PW (R-PDSO-G14)

PLASTIC SMALL OUTLINE



- NOTES:
- All linear dimensions are in millimeters.
 - This drawing is subject to change without notice.
 - Publication IPC-7351 is recommended for alternate designs.
 - Laser cutting apertures with trapezoidal walls and also rounding corners will offer better paste release. Customers should contact their board assembly site for stencil design recommendations. Refer to IPC-7525 for other stencil recommendations.
 - Customers should contact their board fabrication site for solder mask tolerances between and around signal pads.



D0008A

PACKAGE OUTLINE

SOIC - 1.75 mm max height

SMALL OUTLINE INTEGRATED CIRCUIT



4214825/C 02/2019

NOTES:

- Linear dimensions are in inches [millimeters]. Dimensions in parenthesis are for reference only. Controlling dimensions are in inches. Dimensioning and tolerancing per ASME Y14.5M.
- This drawing is subject to change without notice.
- This dimension does not include mold flash, protrusions, or gate burrs. Mold flash, protrusions, or gate burrs shall not exceed $.006$ [0.15] per side.
- This dimension does not include interlead flash.
- Reference JEDEC registration MS-012, variation AA.

EXAMPLE BOARD LAYOUT

D0008A

SOIC - 1.75 mm max height

SMALL OUTLINE INTEGRATED CIRCUIT



LAND PATTERN EXAMPLE
 EXPOSED METAL SHOWN
 SCALE:8X



SOLDER MASK DETAILS

4214825/C 02/2019

NOTES: (continued)

- 6. Publication IPC-7351 may have alternate designs.
- 7. Solder mask tolerances between and around signal pads can vary based on board fabrication site.

EXAMPLE STENCIL DESIGN

D0008A

SOIC - 1.75 mm max height

SMALL OUTLINE INTEGRATED CIRCUIT



SOLDER PASTE EXAMPLE
BASED ON .005 INCH [0.125 MM] THICK STENCIL
SCALE:8X

4214825/C 02/2019

NOTES: (continued)

8. Laser cutting apertures with trapezoidal walls and rounded corners may offer better paste release. IPC-7525 may have alternate design recommendations.
9. Board assembly site may have different recommendations for stencil design.



- NOTES:
- A. All linear dimensions are in millimeters.
 - B. This drawing is subject to change without notice.
 - C. Publication IPC-7351 is recommended for alternate designs.
 - D. Laser cutting apertures with trapezoidal walls and also rounding corners will offer better paste release. Customers should contact their board assembly site for stencil design recommendations. Refer to IPC-7525 for other stencil recommendations.
 - E. Customers should contact their board fabrication site for solder mask tolerances between and around signal pads.

IMPORTANT NOTICE AND DISCLAIMER

TI PROVIDES TECHNICAL AND RELIABILITY DATA (INCLUDING DATASHEETS), DESIGN RESOURCES (INCLUDING REFERENCE DESIGNS), APPLICATION OR OTHER DESIGN ADVICE, WEB TOOLS, SAFETY INFORMATION, AND OTHER RESOURCES "AS IS" AND WITH ALL FAULTS, AND DISCLAIMS ALL WARRANTIES, EXPRESS AND IMPLIED, INCLUDING WITHOUT LIMITATION ANY IMPLIED WARRANTIES OF MERCHANTABILITY, FITNESS FOR A PARTICULAR PURPOSE OR NON-INFRINGEMENT OF THIRD PARTY INTELLECTUAL PROPERTY RIGHTS.

These resources are intended for skilled developers designing with TI products. You are solely responsible for (1) selecting the appropriate TI products for your application, (2) designing, validating and testing your application, and (3) ensuring your application meets applicable standards, and any other safety, security, or other requirements. These resources are subject to change without notice. TI grants you permission to use these resources only for development of an application that uses the TI products described in the resource. Other reproduction and display of these resources is prohibited. No license is granted to any other TI intellectual property right or to any third party intellectual property right. TI disclaims responsibility for, and you will fully indemnify TI and its representatives against, any claims, damages, costs, losses, and liabilities arising out of your use of these resources.

TI's products are provided subject to TI's Terms of Sale (www.ti.com/legal/termsofsale.html) or other applicable terms available either on ti.com or provided in conjunction with such TI products. TI's provision of these resources does not expand or otherwise alter TI's applicable warranties or warranty disclaimers for TI products.

Mailing Address: Texas Instruments, Post Office Box 655303, Dallas, Texas 75265
Copyright © 2019, Texas Instruments Incorporated

Looking for pricing, stock, or lifecycle information?

Click below to explore more details on WIN SOURCE:

 [View LMV844QMA/NOPB on WIN SOURCE](#)

 [Texas Instruments](#) Information

Optimize Your Supply Chain with WIN SOURCE Solutions

-  Global Sourcing Solution
-  Obsolete Management
-  Cost Control Management
-  Shortage Management
-  Alternative Solution
-  Excess Inventory Management