



**THE DATASHEET OF  
Q4010L4**



# Qxx10xx & Qxx10xHx Series

## 10 Amp Standard & Alternistor (High Commutation) Triacs

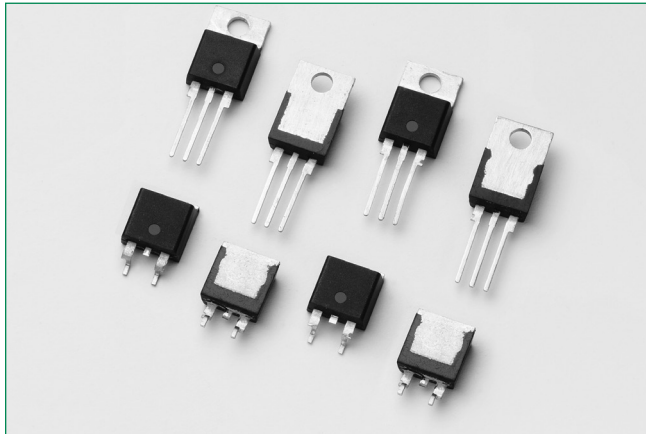

### Description

The Qxx10xx and Qxx10xHx Series are 10 Amp bi-directional solid state switches. They are designed for AC switching and phase control applications such as motor speed and temperature modulation controls, lighting controls, and static switching relays. Standard type devices normally operate in Quadrants I & III triggered from AC line.

### Features & Benefits

- RoHS-compliant
- Glass – passivated junctions
- Voltage capability up to 1000 V
- Surge capability up to 120 A
- 2500Vrms min. isolation between mounting tab and active terminals
- Solid-state switching eliminates arcing or contact bounce that create voltage transients
- No contacts to wear out from reaction of switching events
- Restricted (or limited) RFI generation, depending on activation point sine wave
- UL Recognized to UL 1557 as an Electrically Isolated Semiconductor Device

### Additional Information



Resources



Accessories



Samples

### Agency Approval

| Agency | Agency File Number |
|--------|--------------------|
|        | E71639*            |

\* - L Package Only

### Applications

Alternistor type devices are used in applications requiring high commutation performance such as controlling inductive loads. Isolated packages are offered with internal construction, having the case or mounting tab electrically isolated from the semiconductor chip.

### Main Features

| Symbol            | Value       | Unit |
|-------------------|-------------|------|
| $I_{T(RMS)}$      | 10          | A    |
| $V_{DRM}/V_{RRM}$ | 400 to 1000 | V    |
| $I_{GT(Q1)}$      | 5 to 50     | mA   |

### Schematic Symbol

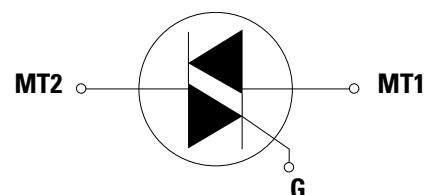

# Qxx10xx & Qxx10xHx Series

## 10 Amp Standard & Alternistor (High Commutation) Triacs

### Absolute Maximum Ratings – Standard Triac

| Symbol       | Parameter   | Value   | Unit       |                        |
|--------------|---|---|------------|------------------------|
| $I_{T(RMS)}$ | RMS on-state current (full sine wave)   | Qxx10Ry/Qxx10Ny $T_C = 95^\circ\text{C}$                                    | 10         | A                      |
|              |   | Qxx10Ly $T_C = 90^\circ\text{C}$  |            |                        |
| $I_{TSM}$    | Non repetitive surge peak on-state current (full cycle, $T_J$ initial = $25^\circ\text{C}$ )        | $f = 50\text{ Hz}$ $t = 20\text{ ms}$                                       | 100        | A                      |
|              |   | $f = 60\text{ Hz}$ $t = 16.7\text{ ms}$                                     | 120        |                        |
| $I^2t$       | $I^2t$ Value for fusing   | $t_p = 8.3\text{ ms}$   | 60         | $\text{A}^2\text{s}$   |
| $di/dt$      | Critical rate of rise of on-state current $I_G = 200\text{mA}$ with $\leq 0.1\mu\text{s}$ rise time | $f = 120\text{ Hz}$ $T_J = 125^\circ\text{C}$                               | 70         | $\text{A}/\mu\text{s}$ |
| $I_{GTM}$    | Peak gate trigger current   | $t_p \leq 10\mu\text{s}$<br>$I_{GT} \leq I_{GTM}$ $T_J = 125^\circ\text{C}$ | 1.8        | A                      |
| $P_{G(AV)}$  | Average gate power dissipation  | $T_J = 125^\circ\text{C}$   | 0.5        | W                      |
| $T_{stg}$    | Storage temperature range   |   | -40 to 150 | $^\circ\text{C}$       |
| $T_J$        | Operating junction temperature range  |   | -40 to 125 | $^\circ\text{C}$       |

### Absolute Maximum Ratings – Alternistor Triac (3 Quadrants)

| Symbol       | Parameter  | Value   | Unit       |                        |
|--------------|--|---|------------|------------------------|
| $I_{T(RMS)}$ | RMS on-state current (full sine wave)  | Qxx10LHy $T_C = 90^\circ\text{C}$   | 10         | A                      |
|              |  | Qxx10RHx/Qxx10NHx $T_C = 95^\circ\text{C}$                                  |            |                        |
| $I_{TSM}$    | Non repetitive surge peak on-state current (full cycle, $T_J$ initial = $25^\circ\text{C}$ ) | $f = 50\text{ Hz}$ $t = 20\text{ ms}$                                       | 110        | A                      |
|              |  | $f = 60\text{ Hz}$ $t = 16.7\text{ ms}$                                     | 120        |                        |
| $I^2t$       | $I^2t$ Value for fusing  | $t_p = 8.3\text{ ms}$   | 60         | $\text{A}^2\text{s}$   |
| $di/dt$      | Critical rate of rise of on-state current  | $f = 120\text{ Hz}$ $T_J = 125^\circ\text{C}$                               | 70         | $\text{A}/\mu\text{s}$ |
| $I_{GTM}$    | Peak gate trigger current  | $t_p \leq 10\mu\text{s}$<br>$I_{GT} \leq I_{GTM}$ $T_J = 125^\circ\text{C}$ | 2.0        | A                      |
| $P_{G(AV)}$  | Average gate power dissipation   | $T_J = 125^\circ\text{C}$   | 0.5        | W                      |
| $T_{stg}$    | Storage temperature range  | -   | -40 to 150 | $^\circ\text{C}$       |
| $T_J$        | Operating junction temperature range   | -   | -40 to 125 | $^\circ\text{C}$       |

### Electrical Characteristics ( $T_J = 25^\circ\text{C}$ , unless otherwise specified) – Standard Triac

| Symbol      | Test Conditions  | Quadrant     | Qxx10x4 | Qxx10x5  | Unit                   |
|-------------|--|--------------|---------|----------|------------------------|
| $I_{GT}$    | $V_D = 12\text{V}$ $R_L = 60\ \Omega$                                  | I – II – III | 25      | 50       | mA                     |
|             |  | IV           | 50      | 75 (TYP) |                        |
| $V_{GT}$    | $V_D = 12\text{V}$ $R_L = 60\ \Omega$                                  | I – II – III | 1.3     |          | V                      |
| $V_{GD}$    | $V_D = V_{DRM}$ $R_L = 3.3\text{ k}\Omega$ $T_J = 125^\circ\text{C}$   | ALL          | 0.2     |          | V                      |
| $I_H$       | $I_T = 200\text{mA}$   |              | 35      | 50       | mA                     |
| $dv/dt$     | $V_D = V_{DRM}$ Gate Open $T_J = 125^\circ\text{C}$                    | 400V         | 150     | 225      | $\text{V}/\mu\text{s}$ |
|             |  | 600V         | 100     | 200      |                        |
|             |  | 800V         | 75      | 175      |                        |
|             | $V_D = V_{DRM}$ Gate Open $T_J = 100^\circ\text{C}$                    | 1000V        | 50      | 150      |                        |
| $(dv/dt)_c$ | $(di/dt)_c = 5.4\text{ A/ms}$ $T_J = 125^\circ\text{C}$                |              | 2       | 4        | $\text{V}/\mu\text{s}$ |
| $t_{gt}$    | $I_G = 2 \times I_{GT}$ $PW = 15\mu\text{s}$ $I_T = 14.1\text{ A(pk)}$ |              | 3.0     | 3.0      | $\mu\text{s}$          |

Note: xx = voltage, x = package, y = sensitivity

# Qxx10xx & Qxx10xHx Series

## 10 Amp Standard & Alternistor (High Commutation) Triacs

### Electrical Characteristics ( $T_J = 25^\circ\text{C}$ , unless otherwise specified) — Alternistor Triac (3 Quadrants)

| Symbol    | Test Conditions  | Quadrant |      | Value    |          | Unit          |
|-----------|--|----------|------|----------|----------|---------------|
|           |  |          |      | Qxx10xH2 | Qxx10xH5 |               |
| $I_{GT}$  | $V_D = 12\text{V}, R_L = 60\Omega$                                 | I-II-III | MAX  | 5        | 50       | m A           |
| $V_{GT}$  |  |          | MAX  | 1.3      | 1.3      | V             |
| $V_{GD}$  |  |          | MIN  | 0.2      | 0.2      | V             |
| $I_H$     | $V_D = V_{DRM}, R_L = 3.3\text{k}\Omega, T_J = 125^\circ\text{C}$  |          | MAX  | 10       | 50       | m A           |
|           | Initial $I_T = 100\text{mA}$                                       |          |      |          |          |               |
| dv/dt     | $V_D = V_{DRM}, \text{Gate Open}, T_J = 125^\circ\text{C}$         | 400V     | MIN. | -        | 750      | V/us          |
|           |  | 600V     |      | -        | 650      |               |
|           |  | 800V     |      | -        | 500      |               |
|           | $V_D = V_{DRM}, \text{Gate Open}, T_J = 100^\circ\text{C}$         | 1000V    |      | -        | 300      |               |
|           | $V_D = 2/3 V_{DRM}, \text{Gate Open}, T_J = 125^\circ\text{C}$     | 800V     |      | 150      | -        |               |
| (dv/dt)/c | (di/dt)/c = 5.4 A/ms, $T_J = 125^\circ\text{C}$                    |          | TYP. | 3.5      | 30       | V/us          |
| tgt       | $IG = 2 \times I_{GT}, PW = 15\mu\text{s}, I_T = 14.1\text{A(pk)}$ |          | TYP. | 3        | 4        | $\mu\text{s}$ |

### Static Characteristics

| Symbol                 | Test Conditions         |                           | Value      | Unit |               |
|------------------------|-------------------------|---------------------------|------------|------|---------------|
| $V_{TM}$               | $I_{TM} = 14.1\text{A}$ | $t_p = 380\mu\text{s}$    | MAX.       | 1.60 |               |
| $I_{DRM}$<br>$I_{RRM}$ | $V_{DRM} = V_{RRM}$     | $T_J = 25^\circ\text{C}$  | 400 - 600V | MAX. |               |
|                        |                         | $T_J = 125^\circ\text{C}$ | 400 - 800V |      |               |
|                        |                         | $T_J = 100^\circ\text{C}$ | 1000V      |      |               |
|                        |                         |                           |            | 10   | $\mu\text{A}$ |
|                        |                         |                           |            | 2    | mA            |
|                        |                         |                           |            | 3    |               |

### Thermal Resistances

| Symbol            | Parameter                |                   | Value | Unit               |
|-------------------|--------------------------|-------------------|-------|--------------------|
| $R_{\theta(J-C)}$ | Junction to case (AC)    | Qxx10Ryy/Qxx10Nyy | 1.3   | $^\circ\text{C/W}$ |
|                   |                          | Qxx10Lyy          | 2.6   |                    |
| $R_{\theta(J-A)}$ | Junction to ambient (AC) | Qxx10Ryy          | 45    | $^\circ\text{C/W}$ |
|                   |                          | Qxx10Lyy          | 50    |                    |

Note: xx = voltage, x = package, y = sensitivity, yy = type & sensitivity

# Qxx10xx & Qxx10xHx Series

## 10 Amp Standard & Alternistor (High Commutation) Triacs

**Figure 1:**  
Definition of Quadrants

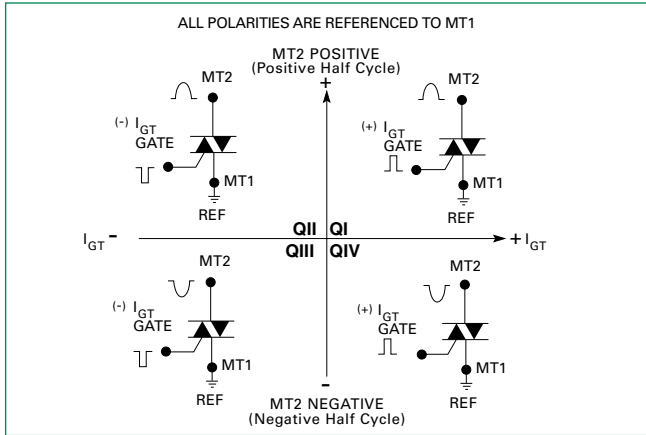

**Figure 2:**  
Normalized DC Gate Trigger Current for All Quadrants vs. Junction Temperature

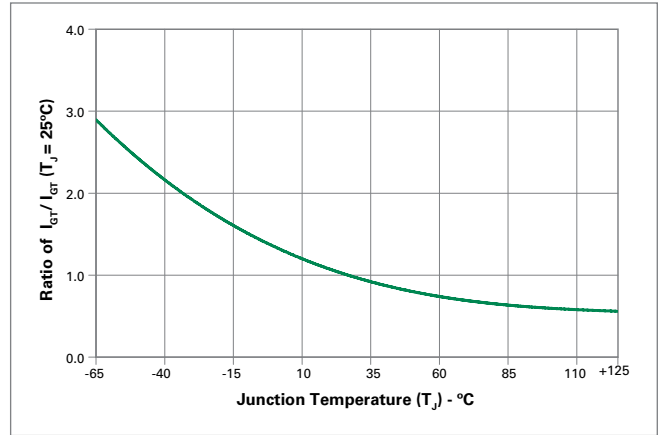

**Figure 3:**  
Normalized DC Holding Current vs. Junction Temperature

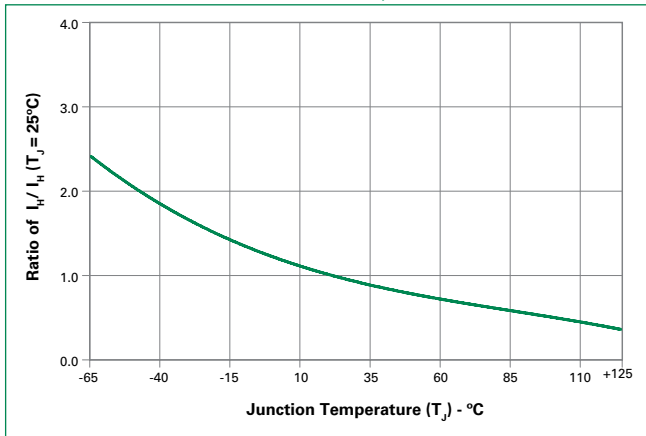

**Figure 4:**  
Normalized DC Gate Trigger Voltage for All Quadrants vs. Junction Temperature

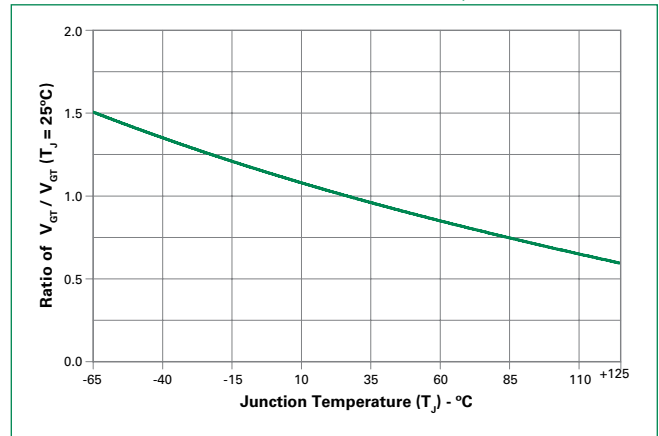

**Figure 5:**  
Power Dissipation (Typical) vs. RMS On-State Current

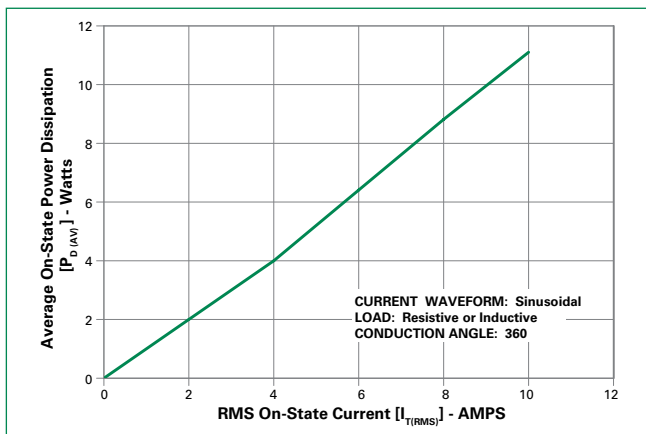

**Figure 6:**  
Maximum Allowable Case Temperature vs. On-State Current

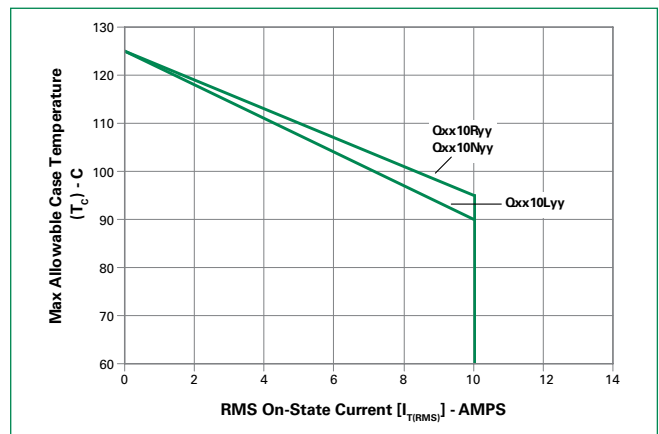

# Qxx10xx & Qxx10xHx Series

## 10 Amp Standard & Alternistor (High Commutation) Triacs

**Figure 7:**  
Maximum Allowable Ambient Temperature vs. On-State Current

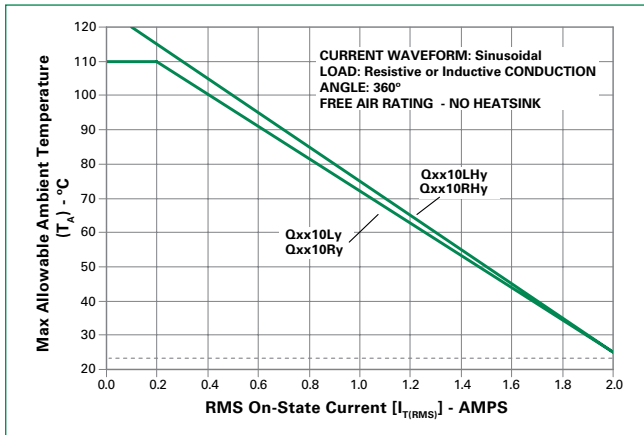

**Figure 8:**  
On-State Current vs. On-State Voltage (Typical)

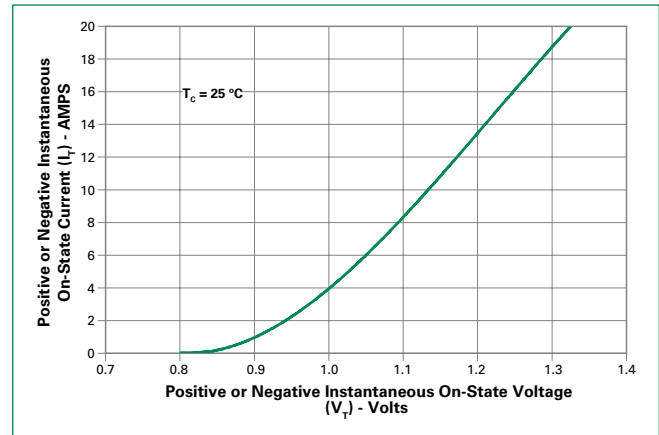

**Figure 9:**  
Surge Peak On-State Current vs. Number of Cycles

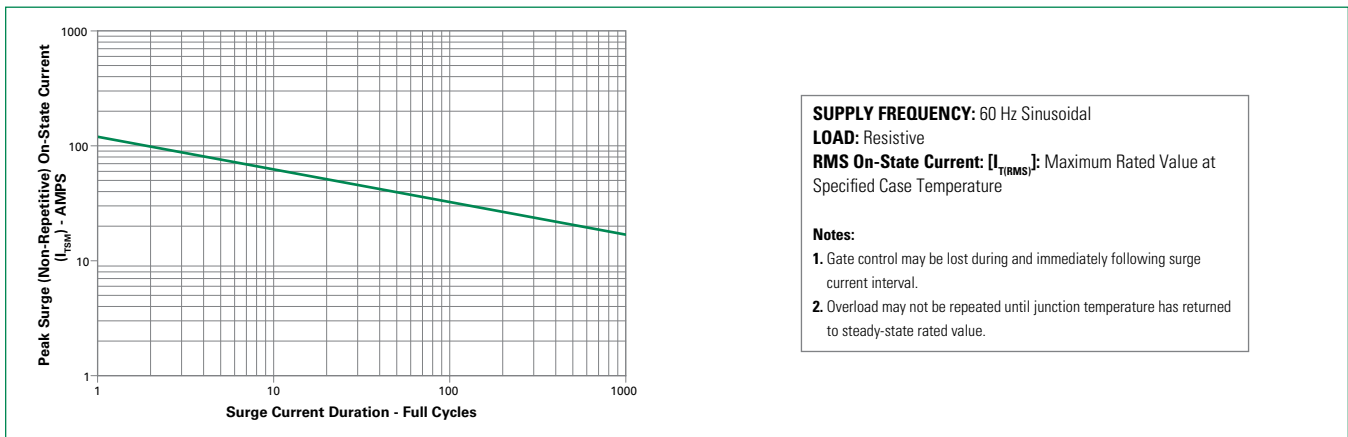

# Qxx10xx & Qxx10xHx Series

## 10 Amp Standard & Alternistor (High Commutation) Triacs

### Soldering Parameters

|  |                                    |                         |
|--|------------------------------------|-------------------------|
| <b>Reflow Condition</b>  |                                    | Pb – Free assembly      |
| <b>Pre Heat</b>  | - Temperature Min ( $T_{s(min)}$ ) | 150°C                   |
|  | - Temperature Max ( $T_{s(max)}$ ) | 200°C                   |
|  | - Time (min to max) ( $t_s$ )      | 60 – 180 secs           |
| <b>Average ramp up rate (Liquidus Temp) (<math>T_L</math>) to peak</b> |                                    | 5°C/second max          |
| <b><math>T_{s(max)}</math> to <math>T_L</math> - Ramp-up Rate</b>      |                                    | 5°C/second max          |
| <b>Reflow</b>  | - Temperature ( $T_L$ ) (Liquidus) | 217°C                   |
|  | - Time (min to max) ( $t_s$ )      | 60 – 150 seconds        |
| <b>Peak Temperature (<math>T_p</math>)</b>                             |                                    | 260 <sup>+0/-5</sup> °C |
| <b>Time within 5°C of actual peak Temperature (<math>t_p</math>)</b>   |                                    | 20 – 40 seconds         |
| <b>Ramp-down Rate</b>  |                                    | 5°C/second max          |
| <b>Time 25°C to peak Temperature (<math>T_p</math>)</b>                |                                    | 8 minutes Max.          |
| <b>Do not exceed</b>   |                                    | 280°C                   |

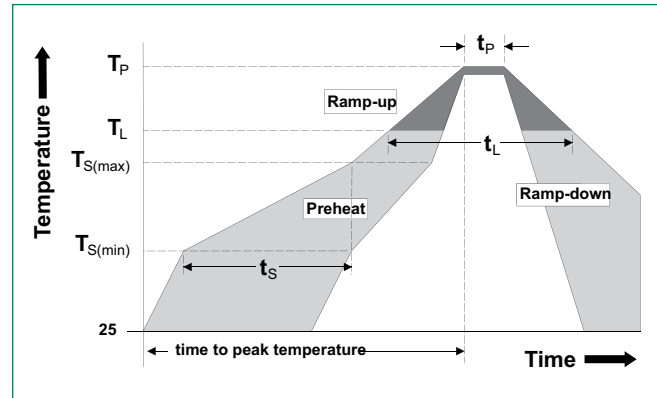

### Physical Specifications

|                          |  |
|--------------------------|--|
| <b>Terminal Finish</b>   | 100% Matte Tin-plated  |
| <b>Body Material</b>     | UL recognized epoxy meeting flammability classification 94V-0. |
| <b>Terminal Material</b> | Copper Alloy   |

### Design Considerations

Careful selection of the correct device for the application's operating parameters and environment will go a long way toward extending the operating life of the Thyristor. Good design practice should limit the maximum continuous current through the main terminals to 75% of the device rating. Other ways to ensure long life for a power discrete semiconductor are proper heat sinking and selection of voltage ratings for worst case conditions. Overheating, overvoltage (including  $dv/dt$ ), and surge currents are the main killers of semiconductors. Correct mounting, soldering, and forming of the leads also help protect against component damage.

### Environmental Specifications

| Test                             | Specifications and Conditions  |
|----------------------------------|--|
| <b>AC Blocking</b>               | MIL-STD-750, M-1040, Cond A Applied Peak AC voltage @ 125°C for 1008 hours |
| <b>Temperature Cycling</b>       | MIL-STD-750, M-1051, 100 cycles; -40°C to +150°C, 15-min dwell-time        |
| <b>Temperature/Humidity</b>      | EIA/JEDEC, JESD22-A101 1008 hours; 320V - DC: 85°C; 85% rel humidity       |
| <b>High Temp Storage</b>         | MIL-STD-750, M-1031, 1008 hours; 150°C                                     |
| <b>Low-Temp Storage</b>          | 1008 hours; -40°C  |
| <b>Resistance to Solder Heat</b> | MIL-STD-750 Method 2031  |
| <b>Solderability</b>             | ANSI/J-STD-002, category 3 Test A  |
| <b>Lead Bend</b>                 | MIL-STD-750, M-2036 Cond E   |

# Qxx10xx & Qxx10xHx Series

## 10 Amp Standard & Alternistor (High Commutation) Triacs

### Dimensions - TO-220AB (R-Package) - Non-Isolated Mounting Tab Common with Center Lead

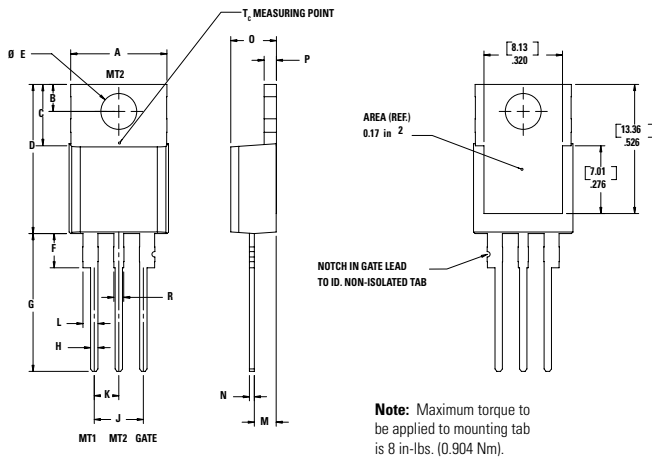

| Dimension | Inches |       | Millimeters |       |
|-----------|--------|-------|-------------|-------|
|           | Min    | Max   | Min         | Max   |
| A         | 0.380  | 0.420 | 9.65        | 10.67 |
| B         | 0.105  | 0.115 | 2.67        | 2.92  |
| C         | 0.230  | 0.250 | 5.84        | 6.35  |
| D         | 0.590  | 0.620 | 14.99       | 15.75 |
| E         | 0.142  | 0.147 | 3.61        | 3.73  |
| F         | 0.110  | 0.130 | 2.79        | 3.30  |
| G         | 0.540  | 0.575 | 13.72       | 14.61 |
| H         | 0.025  | 0.035 | 0.64        | 0.89  |
| J         | 0.195  | 0.205 | 4.95        | 5.21  |
| K         | 0.095  | 0.105 | 2.41        | 2.67  |
| L         | 0.060  | 0.075 | 1.52        | 1.91  |
| M         | 0.085  | 0.095 | 2.16        | 2.41  |
| N         | 0.018  | 0.024 | 0.46        | 0.61  |
| O         | 0.178  | 0.188 | 4.52        | 4.78  |
| P         | 0.045  | 0.060 | 1.14        | 1.52  |
| R         | 0.038  | 0.048 | 0.965       | 1.22  |

### Dimensions - TO-220AB (L-Package) - Isolated Mounting Tab

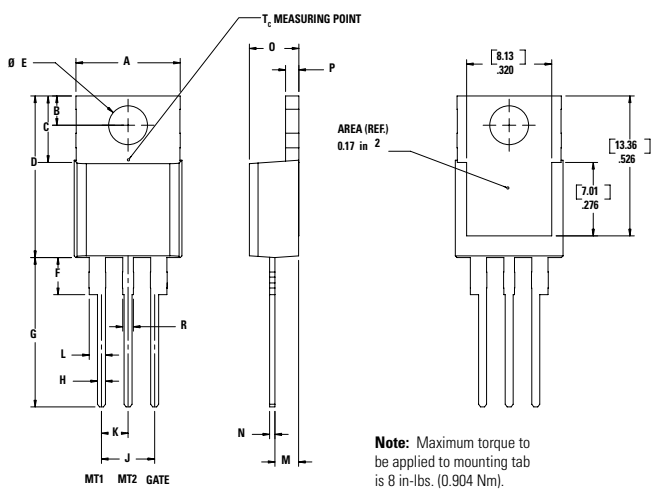

| Dimension | Inches |       | Millimeters |       |
|-----------|--------|-------|-------------|-------|
|           | Min    | Max   | Min         | Max   |
| A         | 0.380  | 0.420 | 9.65        | 10.67 |
| B         | 0.105  | 0.115 | 2.67        | 2.92  |
| C         | 0.230  | 0.250 | 5.84        | 6.35  |
| D         | 0.590  | 0.620 | 14.99       | 15.75 |
| E         | 0.142  | 0.147 | 3.61        | 3.73  |
| F         | 0.110  | 0.130 | 2.79        | 3.30  |
| G         | 0.540  | 0.575 | 13.72       | 14.61 |
| H         | 0.025  | 0.035 | 0.64        | 0.89  |
| J         | 0.195  | 0.205 | 4.95        | 5.21  |
| K         | 0.095  | 0.105 | 2.41        | 2.67  |
| L         | 0.060  | 0.075 | 1.52        | 1.91  |
| M         | 0.085  | 0.095 | 2.16        | 2.41  |
| N         | 0.018  | 0.024 | 0.46        | 0.61  |
| O         | 0.178  | 0.188 | 4.52        | 4.78  |
| P         | 0.045  | 0.060 | 1.14        | 1.52  |
| R         | 0.038  | 0.048 | 0.965       | 1.22  |

# Qxx10xx & Qxx10xHx Series

## 10 Amp Standard & Alternistor (High Commutation) Triacs

### Dimensions - TO-263AB (N-Package) - D2-PAK Surface Mount

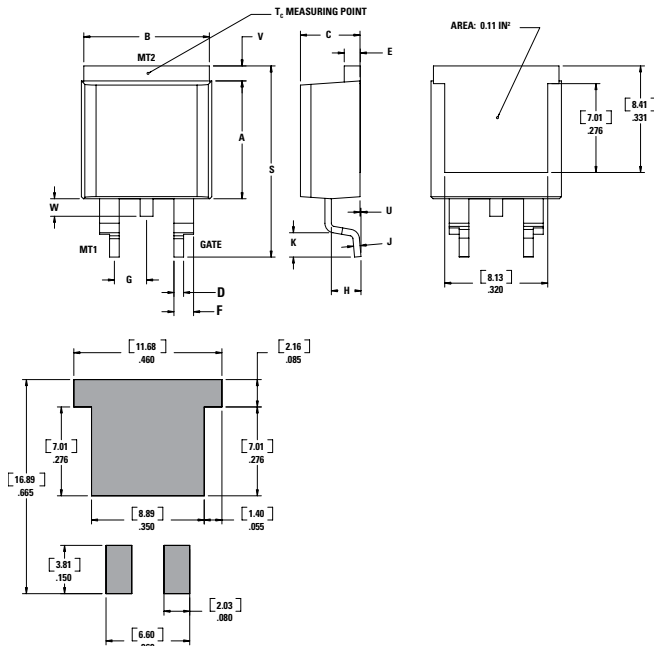

| Dimension | Inches |       | Millimeters |       |
|-----------|--------|-------|-------------|-------|
|           | Min    | Max   | Min         | Max   |
| <b>A</b>  | 0.360  | 0.370 | 9.14        | 9.40  |
| <b>B</b>  | 0.380  | 0.420 | 9.65        | 10.67 |
| <b>C</b>  | 0.178  | 0.188 | 4.52        | 4.78  |
| <b>D</b>  | 0.025  | 0.035 | 0.64        | 0.89  |
| <b>E</b>  | 0.045  | 0.060 | 1.14        | 1.52  |
| <b>F</b>  | 0.060  | 0.075 | 1.52        | 1.91  |
| <b>G</b>  | 0.095  | 0.105 | 2.41        | 2.67  |
| <b>H</b>  | 0.092  | 0.102 | 2.34        | 2.59  |
| <b>J</b>  | 0.018  | 0.024 | 0.46        | 0.61  |
| <b>K</b>  | 0.090  | 0.110 | 2.29        | 2.79  |
| <b>S</b>  | 0.590  | 0.625 | 14.99       | 15.88 |
| <b>V</b>  | 0.035  | 0.045 | 0.89        | 1.14  |
| <b>U</b>  | 0.002  | 0.010 | 0.05        | 0.25  |
| <b>W</b>  | 0.040  | 0.070 | 1.016       | 1.78  |

### Product Selector

| Part Number | Voltage (xx) |      |      |       | Gate Sensitivity Quadrants |            | Type              | Package       |
|-------------|--------------|------|------|-------|----------------------------|------------|-------------------|---------------|
|             | 400V         | 600V | 800V | 1000V | I – II – III               | IV         |                   |               |
| Qxx10LH2    | -            | -    | X    | -     | 5 mA                       | -          | Alternistor Triac | TO-220L       |
| Qxx10RH2    | -            | -    | X    | -     | 5 mA                       | -          | Alternistor Triac | TO-220R       |
| Qxx10NH2    | -            | -    | X    | -     | 5 mA                       | -          | Alternistor Triac | TO-263 D2-PAK |
| Qxx10L4     | X            | X    | X    | X     | 25 mA                      | 50 mA      | Standard Triac    | TO-220L       |
| Qxx10R4     | X            | X    | X    | X     | 25 mA                      | 50 mA      | Standard Triac    | TO-220R       |
| Qxx10N4     | X            | X    | X    | X     | 25 mA                      | 50 mA      | Standard Triac    | TO-263 D2-PAK |
| Qxx10L5     | X            | X    | X    | X     | 50 mA                      | -          | Standard Triac    | TO-220L       |
| Qxx10R5     | X            | X    | X    | X     | 50 mA                      | TYP. 75 mA | Standard Triac    | TO-220R       |
| Qxx10N5     | X            | X    | X    | X     | 50 mA                      | TYP. 75 mA | Standard Triac    | TO-263 D2-PAK |
| Qxx10LH5    | X            | X    | X    | X     | 50 mA                      | TYP. 75 mA | Alternistor Triac | TO-220L       |
| Qxx10RH5    | X            | X    | X    | X     | 50 mA                      | -          | Alternistor Triac | TO-220R       |
| Qxx10NH5    | X            | X    | X    | X     | 50 mA                      | -          | Alternistor Triac | TO-263 D2-PAK |

### Packing Options

| Part Number  | Marking    | Weight | Packing Mode     | Base Quantity      |
|--------------|------------|--------|------------------|--------------------|
| Qxx10L/RyyTP | Qxx10L/Ryy | 2.2 g  | Tube Pack        | 1000 (50 per tube) |
| Qxx10NyyTP   | Qxx10Nyy   | 1.6 g  | Tube             | 1000 (50 per tube) |
| Qxx10NyyRP   | Qxx10Nyy   | 1.6 g  | Embossed Carrier | 500                |

Note: xx = voltage, yy = type & sensitivity

# Qxx10xx & Qxx10xHx Series

## 10 Amp Standard & Alternistor (High Commutation) Triacs

### TO-263 Embossed Carrier Reel Pack (RP) Specifications

Meets all EIA-481-2 Standards

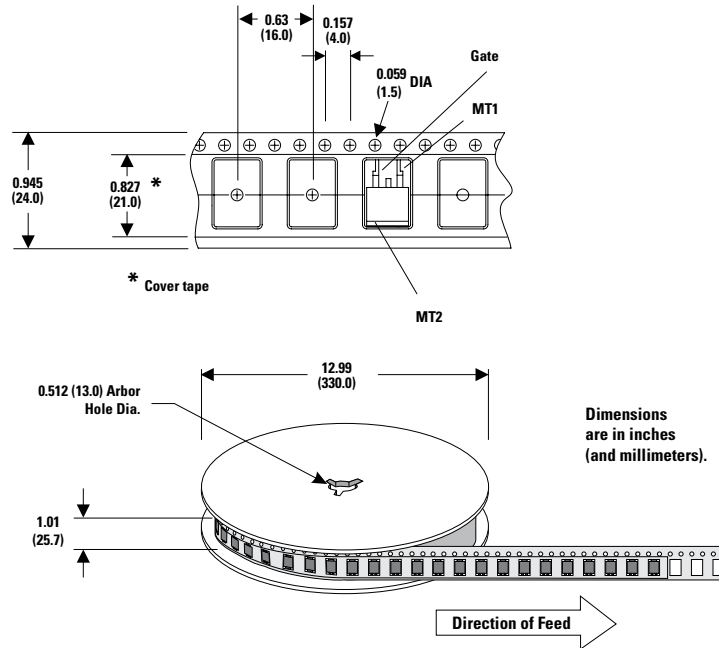

### Part Numbering System

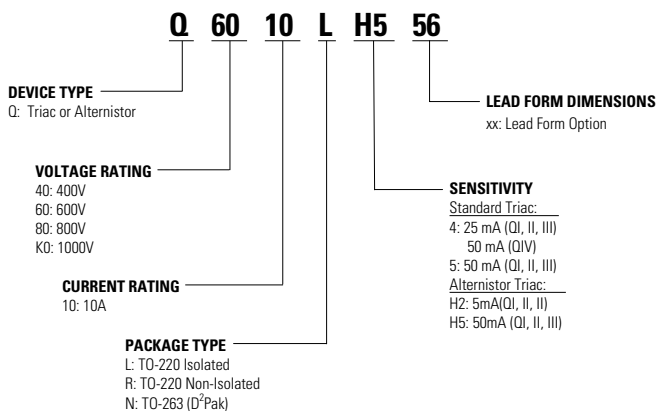

### Part Marking System

TO-220 AB - (L and R Package)  
TO-263 AB - (N Package)

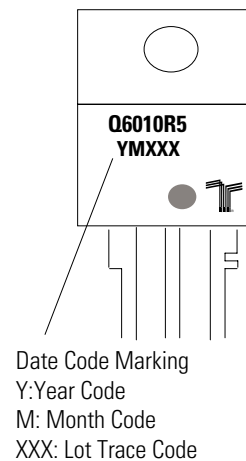

**Disclaimer Notice** - Information furnished is believed to be accurate and reliable. However, users should independently evaluate the suitability of and test each product selected for their own applications. Littelfuse products are not designed for, and may not be used in, all applications. Read complete Disclaimer Notice at [www.littelfuse.com/disclaimer-electronics](http://www.littelfuse.com/disclaimer-electronics).

## Looking for pricing, stock, or lifecycle information?

Click below to explore more details on WIN SOURCE:

 [View Q4010L4 on WIN SOURCE](#)

 [Littelfuse Inc. Information](#)

## Optimize Your Supply Chain with WIN SOURCE Solutions

-  Global Sourcing Solution
-  Obsolete Management
-  Cost Control Management
-  Shortage Management
-  Alternative Solution
-  Excess Inventory Management