



**THE DATASHEET OF  
CY7C1383D-133AXC**





**CY7C1381D**  
**CY7C1383D**  
**CY7C1383F**

# 18-Mbit (512K × 36/1M × 18) Flow-Through SRAM

## Features

- Supports 133 MHz bus operations
- 512K × 36 and 1M × 18 common I/O
- 3.3 V core power supply ( $V_{DD}$ )
- 2.5 V or 3.3 V I/O supply ( $V_{DDQ}$ )
- Fast clock-to-output time
  - 6.5 ns (133 MHz version)
- Provides high performance 2-1-1 access rate
- User selectable burst counter supporting Intel Pentium interleaved or linear burst sequences
- Separate processor and controller address strobes
- Synchronous self-timed write
- Asynchronous output enable
- CY7C1381D available in JEDEC-standard Pb-free 100-pin TQFP, Pb-free and non Pb-free 165-ball FBGA package. CY7C1383D available in JEDEC-standard Pb-free 100-pin TQFP. CY7C1383F available in non Pb-free 165-ball FBGA package.
- IEEE 1149.1 JTAG-Compatible Boundary Scan
- ZZ sleep mode option

## Functional Description

The CY7C1381D/CY7C1383D/CY7C1383F is a 3.3 V, 512K × 36 and 1M × 18 synchronous flow through SRAMs, designed to interface with high speed microprocessors with minimum glue logic. Maximum access delay from clock rise is 6.5 ns (133 MHz version). A 2-bit on-chip counter captures the first address in a burst and increments the address automatically for the rest of the burst access. All synchronous inputs are gated by registers controlled by a positive edge triggered clock input (CLK). The synchronous inputs include all addresses, all data inputs, address pipelining chip enable ( $CE_1$ ), depth-expansion chip enables ( $CE_2$  and  $CE_3$ ), burst control inputs (ADSC, ADSP, and ADV), write enables ( $BW_x$ , and BWE), and global write (GW). Asynchronous inputs include the output enable (OE) and the ZZ pin.

The CY7C1381D/CY7C1383D/CY7C1383F allows interleaved or linear burst sequences, selected by the MODE input pin. A HIGH selects an interleaved burst sequence, while a LOW selects a linear burst sequence. Burst accesses can be initiated with the processor address strobe (ADSP) or the cache controller address strobe (ADSC) inputs. Address advancement is controlled by the address advancement (ADV) input.

Addresses and chip enables are registered at rising edge of clock when address strobe processor (ADSP) or address strobe controller (ADSC) are active. Subsequent burst addresses can be internally generated as controlled by the advance pin (ADV).

CY7C1381D/CY7C1383D/CY7C1383F operates from a +3.3 V core power supply while all outputs operate with a +2.5 V or +3.3 V supply. All inputs and outputs are JEDEC-standard and JESD8-5-compatible.

For a complete list of related documentation, click [here](#).

## Selection Guide

Description	133 MHz	100 MHz	Unit
Maximum Access Time	6.5	8.5	ns
Maximum Operating Current	210	175	mA
Maximum CMOS Standby Current	70	70	mA

**Errata:** For information on silicon errata, see "Errata" on page 32. Details include trigger conditions, devices affected, and proposed workaround.

### Logic Block Diagram – CY7C1381D

(512K x 36) [1]

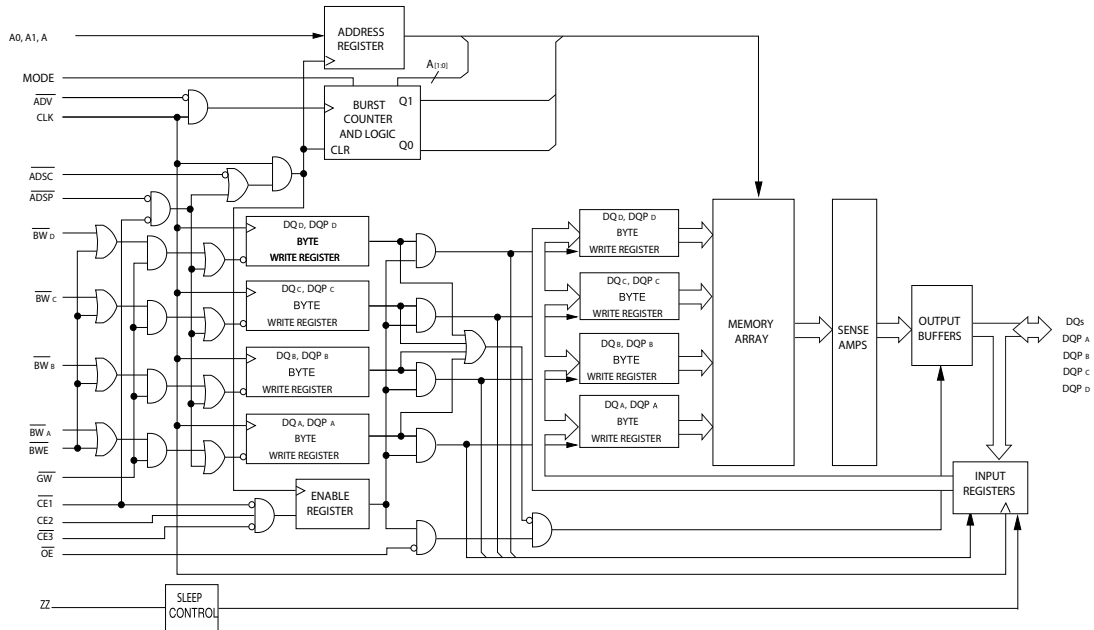

### Logic Block Diagram – CY7C1383D/CY7C1383F

(1M x 18) [1]

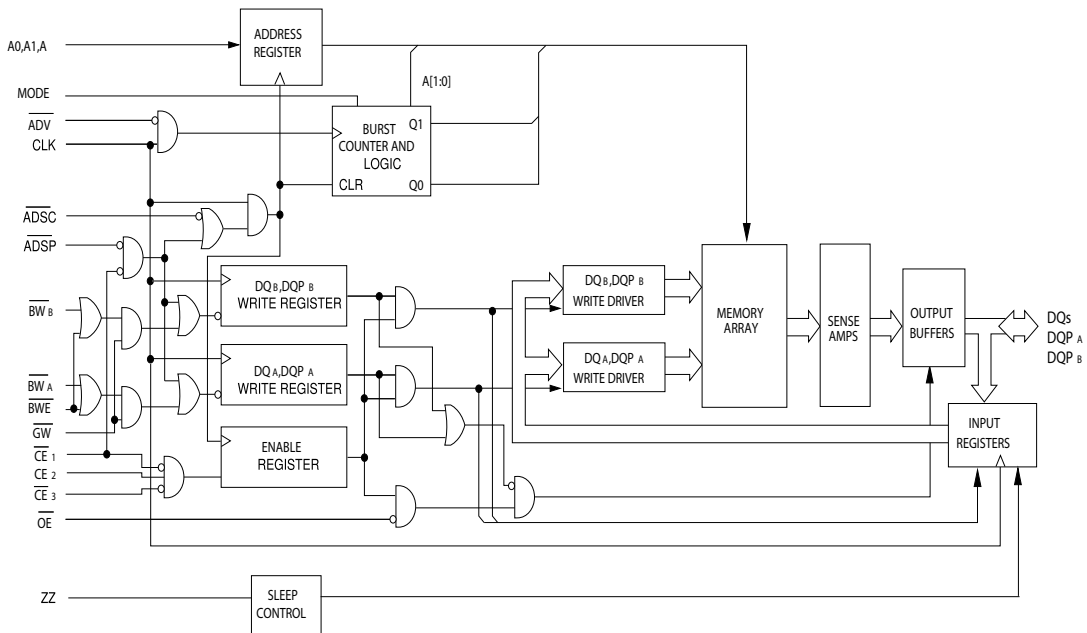

**Note**

1. CY7C1383F have only 1 chip enable ( $\overline{CE}_1$ ).

## Contents

<b>Pin Configurations</b> .....	<b>4</b>	<b>Scan Register Sizes</b> .....	<b>18</b>
<b>Pin Definitions</b> .....	<b>6</b>	<b>Instruction Codes</b> .....	<b>18</b>
<b>Functional Overview</b> .....	<b>8</b>	<b>Boundary Scan Order</b> .....	<b>19</b>
Single Read Accesses .....	8	<b>Maximum Ratings</b> .....	<b>20</b>
Single Write Accesses Initiated by $\overline{\text{ADSP}}$ .....	8	<b>Operating Range</b> .....	<b>20</b>
Single Write Accesses Initiated by ADSC .....	8	<b>Neutron Soft Error Immunity</b> .....	<b>20</b>
Burst Sequences .....	8	<b>Electrical Characteristics</b> .....	<b>20</b>
Sleep Mode .....	8	<b>Capacitance</b> .....	<b>21</b>
Interleaved Burst Address Table .....	9	<b>Thermal Resistance</b> .....	<b>21</b>
Linear Burst Address Table .....	9	<b>AC Test Loads and Waveforms</b> .....	<b>22</b>
ZZ Mode Electrical Characteristics .....	9	<b>Switching Characteristics</b> .....	<b>23</b>
<b>Truth Table</b> .....	<b>10</b>	<b>Timing Diagrams</b> .....	<b>24</b>
<b>Truth Table for Read/Write</b> .....	<b>11</b>	<b>Ordering Information</b> .....	<b>28</b>
<b>Truth Table for Read/Write</b> .....	<b>11</b>	Ordering Code Definitions .....	28
<b>IEEE 1149.1 Serial Boundary Scan (JTAG [14])</b> .....	<b>12</b>	<b>Package Diagrams</b> .....	<b>29</b>
Disabling the JTAG Feature .....	12	<b>Acronyms</b> .....	<b>31</b>
Test Access Port (TAP) .....	12	<b>Document Conventions</b> .....	<b>31</b>
PERFORMING A TAP RESET .....	12	Units of Measure .....	31
TAP REGISTERS .....	12	<b>Errata</b> .....	<b>32</b>
TAP Instruction Set .....	13	Part Numbers Affected .....	32
<b>TAP Controller State Diagram</b> .....	<b>14</b>	Product Status .....	32
<b>TAP Controller Block Diagram</b> .....	<b>15</b>	Ram9 Sync ZZ Pin .....	32
<b>TAP Timing</b> .....	<b>16</b>	& JTAG Issues Errata Summary .....	32
<b>TAP AC Switching Characteristics</b> .....	<b>16</b>	<b>Document History Page</b> .....	<b>34</b>
<b>3.3 V TAP AC Test Conditions</b> .....	<b>17</b>	<b>Sales, Solutions, and Legal Information</b> .....	<b>37</b>
<b>3.3 V TAP AC Output Load Equivalent</b> .....	<b>17</b>	Worldwide Sales and Design Support .....	37
<b>2.5 V TAP AC Test Conditions</b> .....	<b>17</b>	Products .....	37
<b>2.5 V TAP AC Output Load Equivalent</b> .....	<b>17</b>	PSoC® Solutions .....	37
<b>TAP DC Electrical Characteristics</b>		Cypress Developer Community .....	37
<b>and Operating Conditions</b> .....	<b>17</b>	Technical Support .....	37
<b>Identification Register Definitions</b> .....	<b>18</b>		

## Pin Configurations

Figure 1. 100-pin TQFP (14 × 20 × 1.4 mm) pinout (3 Chip Enable) [2]

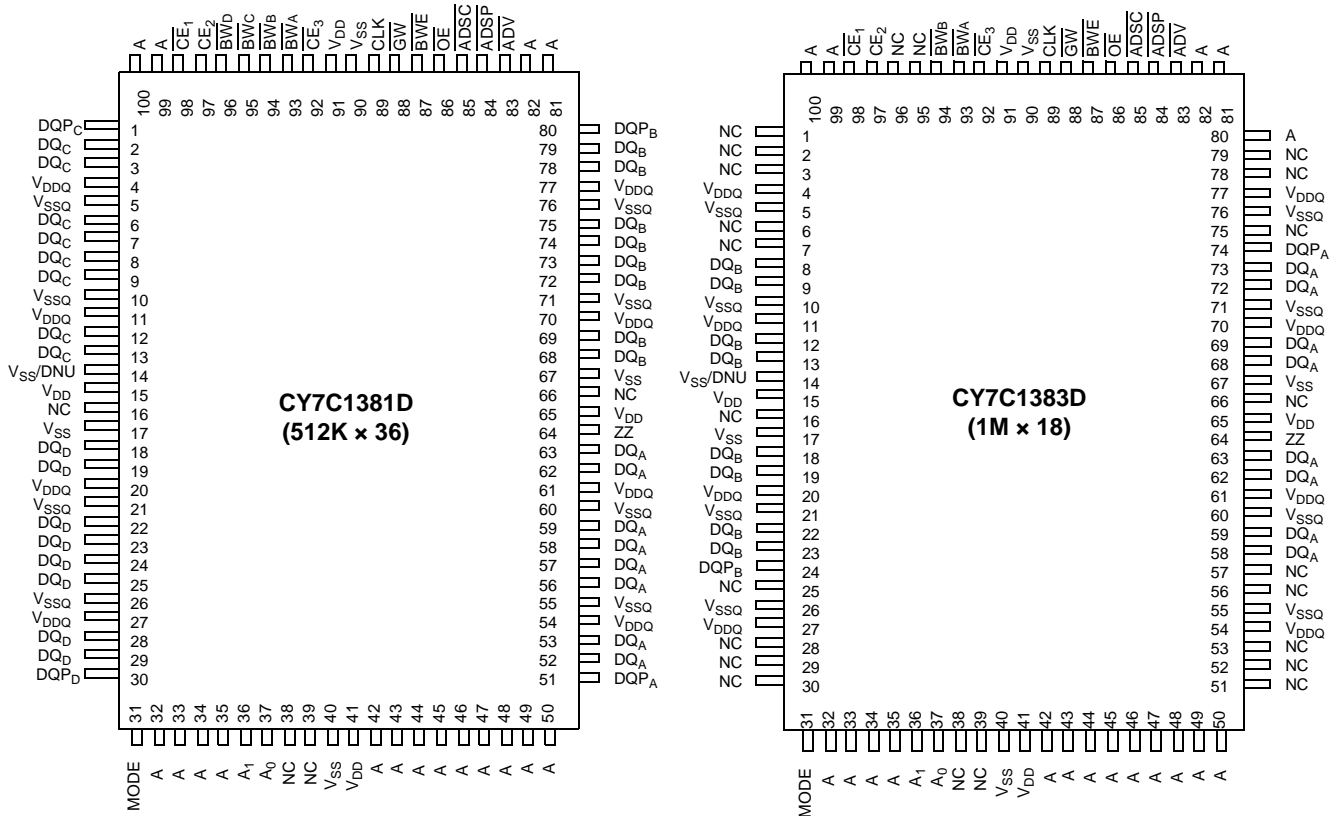

**Note**

2. **Errata:** The ZZ pin (Pin 64) needs to be externally connected to ground. For more information, see "Errata" on page 32.

**Pin Configurations** (continued)

**Figure 2. 165-ball FBGA (13 × 15 × 1.4 mm) pinout(3 Chip Enable) [3, 4]**
**CY7C1381D (512K × 36)**

	1	2	3	4	5	6	7	8	9	10	11
<b>A</b>	NC/288M	A	$\overline{CE}_1$	$\overline{BW}_C$	$\overline{BW}_B$	$\overline{CE}_3$	$\overline{BWE}$	$\overline{ADSC}$	$\overline{ADV}$	A	NC
<b>B</b>	NC/144M	A	$CE_2$	$\overline{BW}_D$	$\overline{BW}_A$	CLK	$\overline{GW}$	$\overline{OE}$	$\overline{ADSP}$	A	NC/576M
<b>C</b>	DQP <sub>C</sub>	NC	V <sub>DDQ</sub>	V <sub>SS</sub>	V <sub>SS</sub>	V <sub>SS</sub>	V <sub>SS</sub>	V <sub>SS</sub>	V <sub>DDQ</sub>	NC/1G	DQP <sub>B</sub>
<b>D</b>	DQ <sub>C</sub>	DQ <sub>C</sub>	V <sub>DDQ</sub>	V <sub>DD</sub>	V <sub>SS</sub>	V <sub>SS</sub>	V <sub>SS</sub>	V <sub>DD</sub>	V <sub>DDQ</sub>	DQ <sub>B</sub>	DQ <sub>B</sub>
<b>E</b>	DQ <sub>C</sub>	DQ <sub>C</sub>	V <sub>DDQ</sub>	V <sub>DD</sub>	V <sub>SS</sub>	V <sub>SS</sub>	V <sub>SS</sub>	V <sub>DD</sub>	V <sub>DDQ</sub>	DQ <sub>B</sub>	DQ <sub>B</sub>
<b>F</b>	DQ <sub>C</sub>	DQ <sub>C</sub>	V <sub>DDQ</sub>	V <sub>DD</sub>	V <sub>SS</sub>	V <sub>SS</sub>	V <sub>SS</sub>	V <sub>DD</sub>	V <sub>DDQ</sub>	DQ <sub>B</sub>	DQ <sub>B</sub>
<b>G</b>	DQ <sub>C</sub>	DQ <sub>C</sub>	V <sub>DDQ</sub>	V <sub>DD</sub>	V <sub>SS</sub>	V <sub>SS</sub>	V <sub>SS</sub>	V <sub>DD</sub>	V <sub>DDQ</sub>	DQ <sub>B</sub>	DQ <sub>B</sub>
<b>H</b>	NC	NC	NC	V <sub>DD</sub>	V <sub>SS</sub>	V <sub>SS</sub>	V <sub>SS</sub>	V <sub>DD</sub>	NC	NC	ZZ
<b>J</b>	DQ <sub>D</sub>	DQ <sub>D</sub>	V <sub>DDQ</sub>	V <sub>DD</sub>	V <sub>SS</sub>	V <sub>SS</sub>	V <sub>SS</sub>	V <sub>DD</sub>	V <sub>DDQ</sub>	DQ <sub>A</sub>	DQ <sub>A</sub>
<b>K</b>	DQ <sub>D</sub>	DQ <sub>D</sub>	V <sub>DDQ</sub>	V <sub>DD</sub>	V <sub>SS</sub>	V <sub>SS</sub>	V <sub>SS</sub>	V <sub>DD</sub>	V <sub>DDQ</sub>	DQ <sub>A</sub>	DQ <sub>A</sub>
<b>L</b>	DQ <sub>D</sub>	DQ <sub>D</sub>	V <sub>DDQ</sub>	V <sub>DD</sub>	V <sub>SS</sub>	V <sub>SS</sub>	V <sub>SS</sub>	V <sub>DD</sub>	V <sub>DDQ</sub>	DQ <sub>A</sub>	DQ <sub>A</sub>
<b>M</b>	DQ <sub>D</sub>	DQ <sub>D</sub>	V <sub>DDQ</sub>	V <sub>DD</sub>	V <sub>SS</sub>	V <sub>SS</sub>	V <sub>SS</sub>	V <sub>DD</sub>	V <sub>DDQ</sub>	DQ <sub>A</sub>	DQ <sub>A</sub>
<b>N</b>	DQP <sub>D</sub>	NC	V <sub>DDQ</sub>	V <sub>SS</sub>	NC	A	NC	V <sub>SS</sub>	V <sub>DDQ</sub>	NC	DQP <sub>A</sub>
<b>P</b>	NC	NC/72M	A	A	TDI	A1	TDO	A	A	A	A
<b>R</b>	MODE	NC/36M	A	A	TMS	A0	TCK	A	A	A	A

**CY7C1383F (1M × 18)**

	1	2	3	4	5	6	7	8	9	10	11
<b>A</b>	NC/288M	A	$\overline{CE}_1$	$\overline{BW}_B$	NC	$\overline{CE}_3$	$\overline{BWE}$	$\overline{ADSC}$	$\overline{ADV}$	A	A
<b>B</b>	NC/144M	A	$CE_2$	NC	$\overline{BW}_A$	CLK	$\overline{GW}$	$\overline{OE}$	$\overline{ADSP}$	A	NC/576M
<b>C</b>	NC	NC	V <sub>DDQ</sub>	V <sub>SS</sub>	V <sub>SS</sub>	V <sub>SS</sub>	V <sub>SS</sub>	V <sub>SS</sub>	V <sub>DDQ</sub>	NC/1G	DQP <sub>A</sub>
<b>D</b>	NC	DQ <sub>B</sub>	V <sub>DDQ</sub>	V <sub>DD</sub>	V <sub>SS</sub>	V <sub>SS</sub>	V <sub>SS</sub>	V <sub>DD</sub>	V <sub>DDQ</sub>	NC	DQ <sub>A</sub>
<b>E</b>	NC	DQ <sub>B</sub>	V <sub>DDQ</sub>	V <sub>DD</sub>	V <sub>SS</sub>	V <sub>SS</sub>	V <sub>SS</sub>	V <sub>DD</sub>	V <sub>DDQ</sub>	NC	DQ <sub>A</sub>
<b>F</b>	NC	DQ <sub>B</sub>	V <sub>DDQ</sub>	V <sub>DD</sub>	V <sub>SS</sub>	V <sub>SS</sub>	V <sub>SS</sub>	V <sub>DD</sub>	V <sub>DDQ</sub>	NC	DQ <sub>A</sub>
<b>G</b>	NC	DQ <sub>B</sub>	V <sub>DDQ</sub>	V <sub>DD</sub>	V <sub>SS</sub>	V <sub>SS</sub>	V <sub>SS</sub>	V <sub>DD</sub>	V <sub>DDQ</sub>	NC	DQ <sub>A</sub>
<b>H</b>	V <sub>SS</sub>	NC	NC	V <sub>DD</sub>	V <sub>SS</sub>	V <sub>SS</sub>	V <sub>SS</sub>	V <sub>DD</sub>	NC	NC	ZZ
<b>J</b>	DQ <sub>B</sub>	NC	V <sub>DDQ</sub>	V <sub>DD</sub>	V <sub>SS</sub>	V <sub>SS</sub>	V <sub>SS</sub>	V <sub>DD</sub>	V <sub>DDQ</sub>	DQ <sub>A</sub>	NC
<b>K</b>	DQ <sub>B</sub>	NC	V <sub>DDQ</sub>	V <sub>DD</sub>	V <sub>SS</sub>	V <sub>SS</sub>	V <sub>SS</sub>	V <sub>DD</sub>	V <sub>DDQ</sub>	DQ <sub>A</sub>	NC
<b>L</b>	DQ <sub>B</sub>	NC	V <sub>DDQ</sub>	V <sub>DD</sub>	V <sub>SS</sub>	V <sub>SS</sub>	V <sub>SS</sub>	V <sub>DD</sub>	V <sub>DDQ</sub>	DQ <sub>A</sub>	NC
<b>M</b>	DQ <sub>B</sub>	NC	V <sub>DDQ</sub>	V <sub>DD</sub>	V <sub>SS</sub>	V <sub>SS</sub>	V <sub>SS</sub>	V <sub>DD</sub>	V <sub>DDQ</sub>	DQ <sub>A</sub>	NC
<b>N</b>	DQP <sub>B</sub>	NC	V <sub>DDQ</sub>	V <sub>SS</sub>	NC	A	NC	V <sub>SS</sub>	V <sub>DDQ</sub>	NC	NC
<b>P</b>	NC	NC/72M	A	A	TDI	A1	TDO	A	A	A	A
<b>R</b>	MODE	NC/36M	A	A	TMS	A0	TCK	A	A	A	A

**Notes**

3. **Errata:** The ZZ ball (H11) needs to be externally connected to ground. For more information, see "Errata" on page 32.

4. **Errata:** The JTAG testing should be performed with these devices in BYPASS mode as the JTAG functionality is not guaranteed. For more information, see "Errata" on page 32.

## Pin Definitions

Name	I/O	Description
A <sub>0</sub> , A <sub>1</sub> , A	Input Synchronous	<b>Address inputs used to select one of the address locations.</b> Sampled at the rising edge of the CLK if $\overline{\text{ADSP}}$ or $\overline{\text{ADSC}}$ is active LOW, and $\overline{\text{CE}}_1$ , $\overline{\text{CE}}_2$ , and $\overline{\text{CE}}_3$ are sampled active. A <sub>[1:0]</sub> feed the 2-bit counter.
$\overline{\text{BW}}_A$ , $\overline{\text{BW}}_B$ , $\overline{\text{BW}}_C$ , $\overline{\text{BW}}_D$	Input Synchronous	<b>Byte write select inputs, active LOW.</b> Qualified with $\overline{\text{BWE}}$ to conduct byte writes to the SRAM. Sampled on the rising edge of CLK.
$\overline{\text{GW}}$	Input Synchronous	<b>Global write enable input, active LOW.</b> When asserted LOW on the rising edge of CLK, a global write is conducted (all bytes are written, regardless of the values on $\overline{\text{BW}}_{[A:D]}$ and $\overline{\text{BWE}}$ ).
CLK	Input Clock	<b>Clock input.</b> Used to capture all synchronous inputs to the device. Also used to increment the burst counter when $\overline{\text{ADV}}$ is asserted LOW, during a burst operation.
$\overline{\text{CE}}_1$	Input Synchronous	<b>Chip enable 1 input, active LOW.</b> Sampled on the rising edge of CLK. Used in conjunction with $\overline{\text{CE}}_2$ and $\overline{\text{CE}}_3$ to select or deselect the device. $\overline{\text{ADSP}}$ is ignored if $\overline{\text{CE}}_1$ is HIGH. $\overline{\text{CE}}_1$ is sampled only when a new external address is loaded.
$\overline{\text{CE}}_2$	Input Synchronous	<b>Chip enable 2 input, active HIGH.</b> Sampled on the rising edge of CLK. Used in conjunction with $\overline{\text{CE}}_1$ and $\overline{\text{CE}}_3$ to select or deselect the device. $\overline{\text{CE}}_2$ is sampled only when a new external address is loaded.
$\overline{\text{CE}}_3$	Input Synchronous	<b>Chip enable 3 input, active LOW.</b> Sampled on the rising edge of CLK. Used in conjunction with $\overline{\text{CE}}_1$ and $\overline{\text{CE}}_2$ to select or deselect the device. $\overline{\text{CE}}_3$ is sampled only when a new external address is loaded.
$\overline{\text{OE}}$	Input Asynchronous	<b>Output enable, asynchronous input, active LOW.</b> Controls the direction of the I/O pins. When LOW, the I/O pins behave as outputs. When deasserted HIGH, I/O pins are tristated, and act as input data pins. $\overline{\text{OE}}$ is masked during the first clock of a read cycle when emerging from a deselected state.
$\overline{\text{ADV}}$	Input Synchronous	<b>Advance input signal.</b> Sampled on the rising edge of CLK. When asserted, it automatically increments the address in a burst cycle.
$\overline{\text{ADSP}}$	Input Synchronous	<b>Address strobe from processor, sampled on the rising edge of CLK, active LOW.</b> When asserted LOW, addresses presented to the device are captured in the address registers. A <sub>[1:0]</sub> are also loaded into the burst counter. When $\overline{\text{ADSP}}$ and $\overline{\text{ADSC}}$ are both asserted, only $\overline{\text{ADSP}}$ is recognized. $\overline{\text{ADSP}}$ is ignored when $\overline{\text{CE}}_1$ is deasserted HIGH.
$\overline{\text{ADSC}}$	Input Synchronous	<b>Address strobe from controller, sampled on the rising edge of CLK, active LOW.</b> When asserted LOW, addresses presented to the device are captured in the address registers. A <sub>[1:0]</sub> are also loaded into the burst counter. When $\overline{\text{ADSP}}$ and $\overline{\text{ADSC}}$ are both asserted, only $\overline{\text{ADSP}}$ is recognized.
$\overline{\text{BWE}}$	Input Synchronous	<b>Byte write enable input, active LOW.</b> Sampled on the rising edge of CLK. This signal must be asserted LOW to conduct a byte write.
ZZ <sup>[5]</sup>	Input Asynchronous	<b>ZZ sleep input.</b> This active HIGH input places the device in a non time critical sleep condition with data integrity preserved. For normal operation, this pin has to be LOW or left floating. ZZ pin has an internal pull down.
DQ <sub>s</sub>	I/O Synchronous	<b>Bidirectional data I/O lines.</b> As inputs, they feed into an on-chip data register that is triggered by the rising edge of CLK. As outputs, they deliver the data contained in the memory location specified by the addresses presented during the previous clock rise of the read cycle. The direction of the pins is controlled by $\overline{\text{OE}}$ . When $\overline{\text{OE}}$ is asserted LOW, the pins behave as outputs. When HIGH, DQ <sub>s</sub> and DQP <sub>x</sub> are placed in a tristate condition. The outputs are automatically tristated during the data portion of a write sequence, during the first clock when emerging from a deselected state, and when the device is deselected, regardless of the state of $\overline{\text{OE}}$ .
DQP <sub>x</sub>	I/O Synchronous	<b>Bidirectional data parity I/O lines.</b> Functionally, these signals are identical to DQ <sub>s</sub> . During write sequences, DQP <sub>x</sub> is controlled by $\overline{\text{BW}}_x$ correspondingly.

### Note

5. **Errata:** The ZZ pin needs to be externally connected to ground. For more information, see "Errata" on page 32.

**Pin Definitions** (continued)

Name	I/O	Description
MODE	Input Static	<b>Selects burst order.</b> When tied to GND selects linear burst sequence. When tied to $V_{DD}$ or left floating selects interleaved burst sequence. This is a strap pin and must remain static during device operation. Mode pin has an internal pull-up.
$V_{DD}$	Power Supply	<b>Power supply inputs to the core of the device.</b>
$V_{DDQ}$	I/O Power Supply	<b>Power supply for the I/O circuitry.</b>
$V_{SS}$	Ground	<b>Ground for the core of the device.</b>
$V_{SSQ}$	I/O Ground	<b>Ground for the I/O circuitry.</b>
TDO <sup>[6]</sup>	JTAG Serial Output Synchronous	<b>Serial data-out to the JTAG circuit.</b> Delivers data on the negative edge of TCK. If the JTAG feature is not being used, this pin can be left unconnected. This pin is not available on TQFP packages.
TDI <sup>[6]</sup>	JTAG Serial Input Synchronous	<b>Serial data-in to the JTAG circuit.</b> Sampled on the rising edge of TCK. If the JTAG feature is not being used, this pin can be left floating or connected to $V_{DD}$ through a pull-up resistor. This pin is not available on TQFP packages.
TMS <sup>[6]</sup>	JTAG Serial Input Synchronous	<b>Serial data-in to the JTAG circuit.</b> Sampled on the rising edge of TCK. If the JTAG feature is not being used, this pin can be disconnected or connected to $V_{DD}$ . This pin is not available on TQFP packages.
TCK <sup>[6]</sup>	JTAG Clock	<b>Clock input to the JTAG circuitry.</b> If the JTAG feature is not being used, this pin must be connected to $V_{SS}$ . This pin is not available on TQFP packages.
NC	–	<b>No connects.</b> Not internally connected to the die. 36M, 72M, 144M, 288M, 576M, and 1G are address expansion pins and are not internally connected to the die.
$V_{SS}/DNU$	Ground/DNU	This pin can be connected to ground or can be left floating.

**Note**

6. **Errata:** The JTAG testing should be performed with these devices in BYPASS mode as the JTAG functionality is not guaranteed. For more information, see “Errata” on page 32.

## Functional Overview

All synchronous inputs pass through input registers controlled by the rising edge of the clock. Maximum access delay from the clock rise ( $t_{CDV}$ ) is 6.5 ns (133 MHz device).

CY7C1381D/CY7C1383D/CY7C1383F supports secondary cache in systems using a linear or interleaved burst sequence. The interleaved burst order supports Pentium and i486 processors. The linear burst sequence is suited for processors that use a linear burst sequence. The burst order is user selectable, and is determined by sampling the MODE input. Accesses can be initiated with the processor address strobe (ADSP) or the controller address strobe (ADSC). Address advancement through the burst sequence is controlled by the ADV input. A two-bit on-chip wraparound burst counter captures the first address in a burst sequence and automatically increments the address for the rest of the burst access.

Byte write operations are qualified with the byte write enable ( $\overline{BWE}$ ) and byte write select ( $\overline{BW_X}$ ) inputs. A global write enable ( $\overline{GW}$ ) overrides all byte write inputs and writes data to all four bytes. All writes are simplified with on-chip synchronous self-timed write circuitry.

Three synchronous chip selects ( $\overline{CE_1}$ ,  $CE_2$ ,  $\overline{CE_3}$ ) and an asynchronous output enable ( $\overline{OE}$ ) provide easy bank selection and output tristate control. ADSP is ignored if  $\overline{CE_1}$  is HIGH.

### Single Read Accesses

A single read access is initiated when the following conditions are satisfied at clock rise: (1)  $\overline{CE_1}$ ,  $CE_2$ , and  $\overline{CE_3}$  are all asserted active, and (2) ADSP or ADSC is asserted LOW (if the access is initiated by ADSC, the write inputs must be deasserted during this first cycle). The address presented to the address inputs is latched into the address register and the burst counter and/or control logic, and later presented to the memory core. If the OE input is asserted LOW, the requested data is available at the data outputs with a maximum to  $t_{CDV}$  after clock rise. ADSP is ignored if  $\overline{CE_1}$  is HIGH.

### Single Write Accesses Initiated by ADSP

This access is initiated when the following conditions are satisfied at clock rise: (1)  $\overline{CE_1}$ ,  $CE_2$ ,  $\overline{CE_3}$  are all asserted active, and (2) ADSP is asserted LOW. The addresses presented are loaded into the address register and the burst inputs ( $\overline{GW}$ ,  $\overline{BWE}$ , and  $\overline{BW_X}$ ) are ignored during this first clock cycle. If the write inputs are asserted active (see [Truth Table for Read/Write on](#)

[page 11](#) for appropriate states that indicate a write) on the next clock rise, the appropriate data is latched and written into the device. Byte writes are allowed. All I/O are tristated during a byte write. As this is a common I/O device, the asynchronous  $\overline{OE}$  input signal must be deasserted and the I/O must be tristated prior to the presentation of data to DQs. As a safety precaution, the data lines are tristated when a write cycle is detected, regardless of the state of  $\overline{OE}$ .

### Single Write Accesses Initiated by ADSC

This write access is initiated when the following conditions are satisfied at clock rise: (1)  $\overline{CE_1}$ ,  $CE_2$ , and  $\overline{CE_3}$  are all asserted active, (2) ADSC is asserted LOW, (3) ADSP is deasserted HIGH, and (4) the write input signals ( $\overline{GW}$ ,  $\overline{BWE}$ , and  $\overline{BW_X}$ ) indicate a write access. ADSC is ignored if ADSP is active LOW.

The addresses presented are loaded into the address register and the burst counter, the control logic, or both, and delivered to the memory core. The information presented to  $DQ_{[A:D]}$  is written into the specified address location. Byte writes are allowed. All I/O are tristated when a write is detected, even a byte write. Because this is a common I/O device, the asynchronous  $\overline{OE}$  input signal must be deasserted and the I/O must be tristated prior to the presentation of data to DQs. As a safety precaution, the data lines are tristated when a write cycle is detected, regardless of the state of  $\overline{OE}$ .

### Burst Sequences

CY7C1381D/CY7C1383D/CY7C1383F provides an on-chip two-bit wraparound burst counter inside the SRAM. The burst counter is fed by  $A_{[1:0]}$ , and can follow either a linear or interleaved burst order. The burst order is determined by the state of the MODE input. A LOW on MODE selects a linear burst sequence. A HIGH on MODE selects an interleaved burst order. Leaving MODE unconnected causes the device to default to a interleaved burst sequence.

### Sleep Mode

The ZZ input pin is an asynchronous input. Asserting ZZ places the SRAM in a power conservation sleep mode. Two clock cycles are required to enter into or exit from this sleep mode. While in this mode, data integrity is guaranteed. Accesses pending when entering the sleep mode are not considered valid nor is the completion of the operation guaranteed. The device must be deselected prior to entering the sleep mode.  $\overline{CE_1}$ ,  $CE_2$ ,  $\overline{CE_3}$ , ADSP, and ADSC must remain inactive for the duration of  $t_{ZZREC}$  after the ZZ input returns LOW.

**Interleaved Burst Address Table**

 (MODE = Floating or  $V_{DD}$ )

First Address A1:A0	Second Address A1:A0	Third Address A1:A0	Fourth Address A1:A0
00	01	10	11
01	00	11	10
10	11	00	01
11	10	01	00

**Linear Burst Address Table**

(MODE = GND)

First Address A1:A0	Second Address A1:A0	Third Address A1:A0	Fourth Address A1:A0
00	01	10	11
01	10	11	00
10	11	00	01
11	00	01	10

**ZZ Mode Electrical Characteristics**

Parameter	Description	Test Conditions	Min	Max	Unit
$I_{DDZZ}$	Sleep mode standby current	$ZZ \geq V_{DD} - 0.2 V$	–	80	mA
$t_{ZZS}$	Device operation to ZZ	$ZZ \geq V_{DD} - 0.2 V$	–	$2t_{CYC}$	ns
$t_{ZZREC}$	ZZ recovery time	$ZZ \leq 0.2 V$	$2t_{CYC}$	–	ns
$t_{ZZI}$	ZZ active to sleep current	This parameter is sampled	–	$2t_{CYC}$	ns
$t_{RZZI}$	ZZ inactive to exit sleep current	This parameter is sampled	0	–	ns

## Truth Table

The truth table for CY7C1381D/CY7C1383D/CY7C1383F follows. [7, 8, 9, 10, 11]

Cycle Description	Address Used	$\overline{CE}_1$	$\overline{CE}_2$	$\overline{CE}_3$	ZZ	$\overline{ADSP}$	$\overline{ADSC}$	$\overline{ADV}$	$\overline{WRITE}$	$\overline{OE}$	CLK	DQ
Deselected Cycle, Power Down	None	H	X	X	L	X	L	X	X	X	L-H	Tri-State
Deselected Cycle, Power Down	None	L	L	X	L	L	X	X	X	X	L-H	Tri-State
Deselected Cycle, Power Down	None	L	X	H	L	L	X	X	X	X	L-H	Tri-State
Deselected Cycle, Power Down	None	L	L	X	L	H	L	X	X	X	L-H	Tri-State
Deselected Cycle, Power Down	None	X	X	H	L	H	L	X	X	X	L-H	Tri-State
Sleep Mode, Power Down	None	X	X	X	H	X	X	X	X	X	X	Tri-State
Read Cycle, Begin Burst	External	L	H	L	L	L	X	X	X	L	L-H	Q
Read Cycle, Begin Burst	External	L	H	L	L	L	X	X	X	H	L-H	Tri-State
Write Cycle, Begin Burst	External	L	H	L	L	H	L	X	L	X	L-H	D
Read Cycle, Begin Burst	External	L	H	L	L	H	L	X	H	L	L-H	Q
Read Cycle, Begin Burst	External	L	H	L	L	H	L	X	H	H	L-H	Tri-State
Read Cycle, Continue Burst	Next	X	X	X	L	H	H	L	H	L	L-H	Q
Read Cycle, Continue Burst	Next	X	X	X	L	H	H	L	H	H	L-H	Tri-State
Read Cycle, Continue Burst	Next	H	X	X	L	X	H	L	H	L	L-H	Q
Read Cycle, Continue Burst	Next	H	X	X	L	X	H	L	H	H	L-H	Tri-State
Write Cycle, Continue Burst	Next	X	X	X	L	H	H	L	L	X	L-H	D
Write Cycle, Continue Burst	Next	H	X	X	L	X	H	L	L	X	L-H	D
Read Cycle, Suspend Burst	Current	X	X	X	L	H	H	H	H	L	L-H	Q
Read Cycle, Suspend Burst	Current	X	X	X	L	H	H	H	H	H	L-H	Tri-State
Read Cycle, Suspend Burst	Current	H	X	X	L	X	H	H	H	L	L-H	Q
Read Cycle, Suspend Burst	Current	H	X	X	L	X	H	H	H	H	L-H	Tri-State
Write Cycle, Suspend Burst	Current	X	X	X	L	H	H	H	L	X	L-H	D
Write Cycle, Suspend Burst	Current	H	X	X	L	X	H	H	L	X	L-H	D

### Notes

7. X = Don't Care, H = Logic HIGH, L = Logic LOW.
8.  $\overline{WRITE}$  = L when any one or more byte write enable signals, and  $\overline{BWE} = L$  or  $\overline{GW} = L$ .  $\overline{WRITE} = H$  when all byte write enable signals,  $\overline{BWE}, \overline{GW} = H$ .
9. The DQ pins are controlled by the current cycle and the  $\overline{OE}$  signal.  $\overline{OE}$  is asynchronous and is not sampled with the clock.
10. The SRAM always initiates a read cycle when  $\overline{ADSP}$  is asserted, regardless of the state of  $\overline{GW}$ ,  $\overline{BWE}$ , or  $\overline{BW}_x$ . Writes may occur only on subsequent clocks after the  $\overline{ADSP}$  or with the assertion of  $\overline{ADSC}$ . As a result,  $\overline{OE}$  must be driven HIGH prior to the start of the write cycle to allow the outputs to tristate.  $\overline{OE}$  is a don't care for the remainder of the write cycle.
11.  $\overline{OE}$  is asynchronous and is not sampled with the clock rise. It is masked internally during write cycles. During a read cycle all data bits are tristate when  $\overline{OE}$  is inactive or when the device is deselected, and all data bits behave as output when  $\overline{OE}$  is active (LOW).

## Truth Table for Read/Write

The truth table for CY7C1381D read/write follows. [12, 13]

Function (CY7C1381D)	$\overline{GW}$	$\overline{BWE}$	$\overline{BW}_D$	$\overline{BW}_C$	$\overline{BW}_B$	$\overline{BW}_A$
Read	H	H	X	X	X	X
Read	H	L	H	H	H	H
Write Byte A (DQ <sub>A</sub> , DQP <sub>A</sub> )	H	L	H	H	H	L
Write Byte B (DQ <sub>B</sub> , DQP <sub>B</sub> )	H	L	H	H	L	H
Write Bytes A, B (DQ <sub>A</sub> , DQ <sub>B</sub> , DQP <sub>A</sub> , DQP <sub>B</sub> )	H	L	H	H	L	L
Write Byte C (DQ <sub>C</sub> , DQP <sub>C</sub> )	H	L	H	L	H	H
Write Bytes C, A (DQ <sub>C</sub> , DQ <sub>A</sub> , DQP <sub>C</sub> , DQP <sub>A</sub> )	H	L	H	L	H	L
Write Bytes C, B (DQ <sub>C</sub> , DQ <sub>B</sub> , DQP <sub>C</sub> , DQP <sub>B</sub> )	H	L	H	L	L	H
Write Bytes C, B, A (DQ <sub>C</sub> , DQ <sub>B</sub> , DQ <sub>A</sub> , DQP <sub>C</sub> , DQP <sub>B</sub> , DQP <sub>A</sub> )	H	L	H	L	L	L
Write Byte D (DQ <sub>D</sub> , DQP <sub>D</sub> )	H	L	L	H	H	H
Write Bytes D, A (DQ <sub>D</sub> , DQ <sub>A</sub> , DQP <sub>D</sub> , DQP <sub>A</sub> )	H	L	L	H	H	L
Write Bytes D, B (DQ <sub>D</sub> , DQ <sub>B</sub> , DQP <sub>D</sub> , DQP <sub>B</sub> )	H	L	L	H	L	H
Write Bytes D, B, A (DQ <sub>D</sub> , DQ <sub>B</sub> , DQ <sub>A</sub> , DQP <sub>D</sub> , DQP <sub>B</sub> , DQP <sub>A</sub> )	H	L	L	H	L	L
Write Bytes D, B (DQ <sub>D</sub> , DQ <sub>B</sub> , DQP <sub>D</sub> , DQP <sub>B</sub> )	H	L	L	L	H	H
Write Bytes D, B, A (DQ <sub>D</sub> , DQ <sub>C</sub> , DQ <sub>A</sub> , DQP <sub>D</sub> , DQP <sub>C</sub> , DQP <sub>A</sub> )	H	L	L	L	H	L

## Truth Table for Read/Write

The truth table for CY7C1383D/CY7C1383F read/write follows. [12, 13]

Function (CY7C1383D/CY7C1383F)	$\overline{GW}$	$\overline{BWE}$	$\overline{BW}_B$	$\overline{BW}_A$
Write Bytes D, C, A (DQ <sub>D</sub> , DQ <sub>B</sub> , DQ <sub>A</sub> , DQP <sub>D</sub> , DQP <sub>B</sub> , DQP <sub>A</sub> )	H	L	L	L
Write All Bytes	H	L	L	L
Write All Bytes	L	X	X	X
Read	H	H	X	X
Read	H	L	H	H
Write Byte A – (DQ <sub>A</sub> and DQP <sub>A</sub> )	H	L	H	L
Write Byte B – (DQ <sub>B</sub> and DQP <sub>B</sub> )	H	L	L	H
Write All Bytes	H	L	L	L
Write All Bytes	L	X	X	X

### Notes

12. X=Don't Care, H = Logic HIGH, L = Logic LOW.

13. The table only lists a partial listing of the byte write combinations. Any combination of  $\overline{BW}_X$  is valid. Appropriate write is done based on which byte write is active.

## IEEE 1149.1 Serial Boundary Scan (JTAG) <sup>[14]</sup>

The CY7C1381D/CY7C1383F incorporates a serial boundary scan test access port (TAP). This part is fully compliant with 1149.1. The TAP operates using JEDEC-standard 3.3 V or 2.5 V I/O logic levels.

CY7C1381D/CY7C1383F contains a TAP controller, instruction register, boundary scan register, bypass register, and ID register.

### Disabling the JTAG Feature

It is possible to operate the SRAM without using the JTAG feature. To disable the TAP controller, TCK must be tied LOW ( $V_{SS}$ ) to prevent clocking of the device. TDI and TMS are internally pulled up and may be unconnected. They may alternately be connected to  $V_{DD}$  through a pull-up resistor. TDO may be left unconnected. At power up, the device comes up in a reset state, which does not interfere with the operation of the device.

### Test Access Port (TAP)

#### Test Clock (TCK)

The test clock is used only with the TAP controller. All inputs are captured on the rising edge of TCK. All outputs are driven from the falling edge of TCK.

#### Test Mode Select (TMS)

The TMS input is used to give commands to the TAP controller and is sampled on the rising edge of TCK. This pin may be left unconnected if the TAP is not used. The ball is pulled up internally, resulting in a logic HIGH level.

#### Test Data-In (TDI)

The TDI ball is used to serially input information into the registers and can be connected to the input of any of the registers. The register between TDI and TDO is chosen by the instruction that is loaded into the TAP instruction register. For information on loading the instruction register, see the [TAP Controller State Diagram on page 14](#). TDI is internally pulled up and can be unconnected if the TAP is unused in an application. TDI is connected to the most significant bit (MSB) of any register.

#### Test Data-Out (TDO)

The TDO output ball is used to serially clock data-out from the registers. The output is active depending upon the current state of the TAP state machine (see [Instruction Codes on page 18](#)). The output changes on the falling edge of TCK. TDO is connected to the least significant bit (LSB) of any register.

### Performing a TAP Reset

A reset is performed by forcing TMS HIGH ( $V_{DD}$ ) for five rising edges of TCK. This reset does not affect the operation of the SRAM and may be performed while the SRAM is operating. At

power up, the TAP is reset internally to ensure that TDO comes up in a high Z state.

### TAP Registers

Registers are connected between the TDI and TDO balls and allow data to be scanned in and out of the SRAM test circuitry. Only one register can be selected at a time through the instruction registers. Data is serially loaded into the TDI ball on the rising edge of TCK. Data is output on the TDO ball on the falling edge of TCK.

#### Instruction Register

Three-bit instructions can be serially loaded into the instruction register. This register is loaded when it is placed between the TDI and TDO balls as shown in the [TAP Controller Block Diagram on page 15](#). Upon power up, the instruction register is loaded with the IDCODE instruction. It is also loaded with the IDCODE instruction if the controller is placed in a reset state as described in the previous section.

When the TAP controller is in the Capture-IR state, the two least significant bits are loaded with a binary '01' pattern to allow for fault isolation of the board level serial test path.

#### Bypass Register

To save time when serially shifting data through registers, it is sometimes advantageous to skip certain chips. The bypass register is a single-bit register that can be placed between the TDI and TDO balls. This allows data to be shifted through the SRAM with minimal delay. The bypass register is set LOW ( $V_{SS}$ ) when the BYPASS instruction is executed.

#### Boundary Scan Register

The boundary scan register is connected to all the input and bidirectional balls on the SRAM.

The boundary scan register is loaded with the contents of the RAM input and output ring when the TAP controller is in the Capture-DR state and is then placed between the TDI and TDO balls when the controller is moved to the Shift-DR state. The EXTTEST, SAMPLE/PRELOAD, and SAMPLE Z instructions can be used to capture the contents of the input and output ring.

The [Boundary Scan Order on page 19](#) show the order in which the bits are connected. Each bit corresponds to one of the bumps on the SRAM package. The MSB of the register is connected to TDI, and the LSB is connected to TDO.

#### Identification (ID) Register

The ID register is loaded with a vendor-specific 32-bit code during the Capture-DR state when the IDCODE command is loaded in the instruction register. The IDCODE is hardwired into the SRAM and can be shifted out when the TAP controller is in the Shift-DR state. The ID register has a vendor code and other information described in [Identification Register Definitions on page 18](#).

#### Note

**14. Errata:** The JTAG testing should be performed with these devices in BYPASS mode as the JTAG functionality is not guaranteed. For more information, see "Errata" on page 32.

## TAP Instruction Set

### Overview

Eight different instructions are possible with the three bit instruction register. All combinations are listed in [Instruction Codes on page 18](#). Three of these instructions are listed as RESERVED and must not be used. The other five instructions are described in detail below.

Instructions are loaded into the TAP controller during the Shift-IR state, when the instruction register is placed between TDI and TDO. During this state, instructions are shifted through the instruction register through the TDI and TDO balls. To execute the instruction when it is shifted in, the TAP controller needs to be moved into the Update-IR state.

### EXTEST

The EXTEST instruction enables the preloaded data to be driven out through the system output pins. This instruction also selects the boundary scan register to be connected for serial access between the TDI and TDO in the Shift-DR controller state.

### IDCODE

The IDCODE instruction causes a vendor-specific 32-bit code to be loaded into the instruction register. It also places the instruction register between the TDI and TDO balls and allows the IDCODE to be shifted out of the device when the TAP controller enters the Shift-DR state.

The IDCODE instruction is loaded into the instruction register upon power up or whenever the TAP controller is given a test logic reset state.

### SAMPLE Z

The SAMPLE Z instruction causes the boundary scan register to be connected between the TDI and TDO balls when the TAP controller is in a Shift-DR state. The SAMPLE Z command places all SRAM outputs into a high Z state.

### SAMPLE/PRELOAD

SAMPLE/PRELOAD is a 1149.1 mandatory instruction. When the SAMPLE/PRELOAD instructions are loaded into the instruction register and the TAP controller is in the Capture-DR state, a snapshot of data on the inputs and output pins is captured in the boundary scan register.

The user must be aware that the TAP controller clock can only operate at a frequency up to 20 MHz, while the SRAM clock operates more than an order of magnitude faster. Because there is a large difference in the clock frequencies, it is possible that during the Capture-DR state, an input or output undergoes a transition. The TAP may then try to capture a signal while in transition (metastable state). This does not harm the device, but

there is no guarantee as to the value that is captured. Repeatable results may not be possible.

To guarantee that the boundary scan register captures the correct value of a signal, the SRAM signal must be stabilized long enough to meet the TAP controller's capture setup plus hold times ( $t_{CS}$  and  $t_{CH}$ ). The SRAM clock input might not be captured correctly if there is no way in a design to stop (or slow) the clock during a SAMPLE/PRELOAD instruction. If this is an issue, it is still possible to capture all other signals and simply ignore the value of the CK and  $\overline{CK}$  captured in the boundary scan register.

After the data is captured, it is possible to shift out the data by putting the TAP into the Shift-DR state. This places the boundary scan register between the TDI and TDO pins.

PRELOAD allows an initial data pattern to be placed at the latched parallel outputs of the boundary scan register cells prior to the selection of another boundary scan test operation.

The shifting of data for the SAMPLE and PRELOAD phases can occur concurrently when required; that is, while data captured is shifted out, the preloaded data is shifted in.

### BYPASS

When the BYPASS instruction is loaded in the instruction register and the TAP is placed in a Shift-DR state, the bypass register is placed between the TDI and TDO balls. The advantage of the BYPASS instruction is that it shortens the boundary scan path when multiple devices are connected together on a board.

### EXTEST Output Bus Tri-State

IEEE standard 1149.1 mandates that the TAP controller be able to put the output bus into a tristate mode.

The boundary scan register has a special bit located at bit #89 (for 165-ball FBGA package). When this scan cell, called the "extest output bus tristate," is latched into the preload register during the Update-DR state in the TAP controller, it directly controls the state of the output (Q-bus) pins, when the EXTEST is entered as the current instruction. When HIGH, it enables the output buffers to drive the output bus. When LOW, this bit places the output bus into a high Z condition.

This bit can be set by entering the SAMPLE/PRELOAD or EXTEST command, and then shifting the desired bit into that cell, during the Shift-DR state. During Update-DR, the value loaded into that shift-register cell latches into the preload register. When the EXTEST instruction is entered, this bit directly controls the output Q-bus pins. Note that this bit is preset HIGH to enable the output when the device is powered up, and also when the TAP controller is in the Test-Logic-Reset state.

### Reserved

These instructions are not implemented but are reserved for future use. Do not use these instructions.

### TAP Controller State Diagram

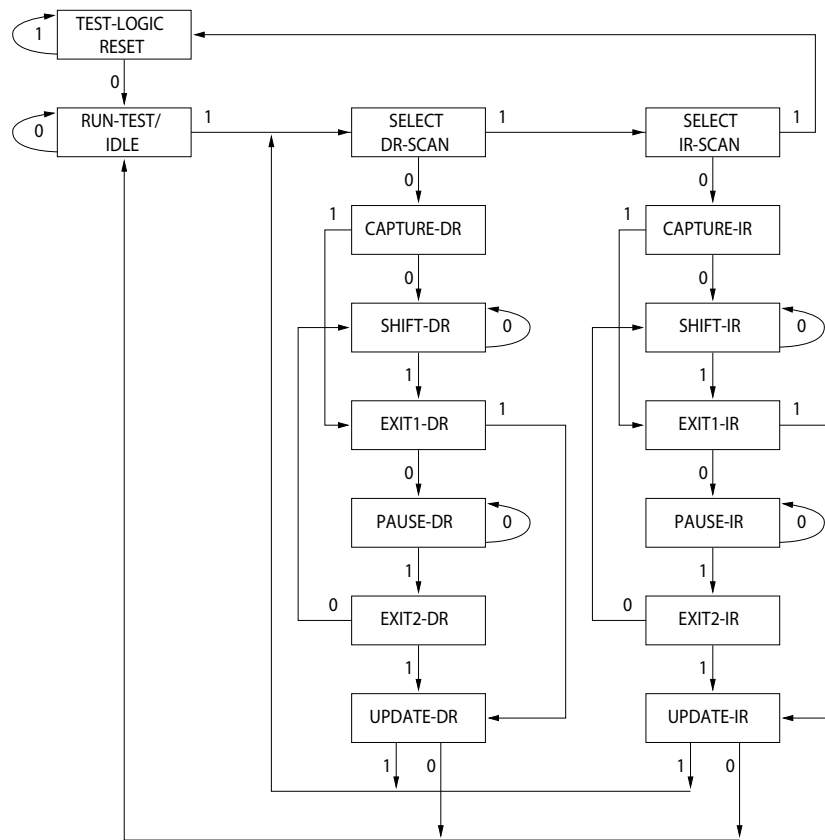

The 0 or 1 next to each state represents the value of TMS at the rising edge of TCK.

### TAP Controller Block Diagram

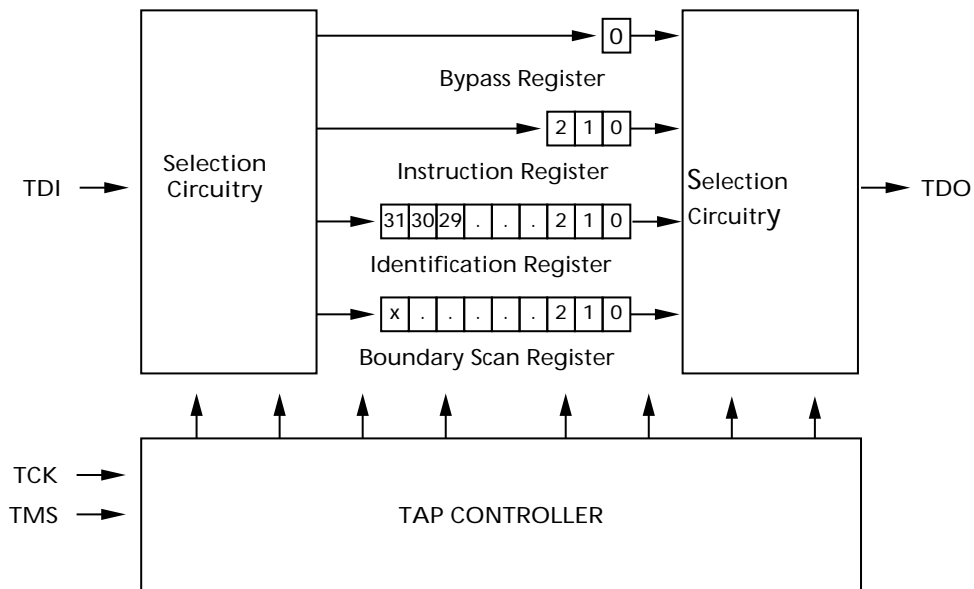

## TAP Timing

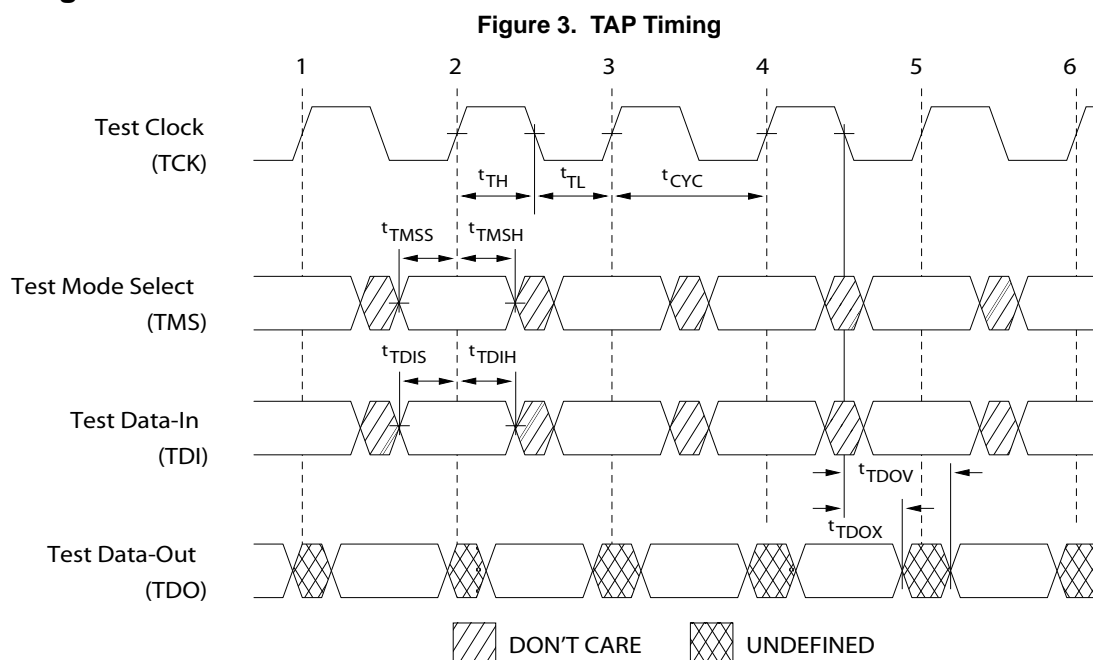

## TAP AC Switching Characteristics

Over the Operating Range

Parameter <sup>[15, 16]</sup>	Description	Min	Max	Unit
<b>Clock</b>				
$t_{TCYC}$	TCK Clock Cycle Time	50	–	ns
$t_{TF}$	TCK Clock Frequency	–	20	MHz
$t_{TH}$	TCK Clock HIGH Time	20	–	ns
$t_{TL}$	TCK Clock LOW Time	20	–	ns
<b>Output Times</b>				
$t_{TDOV}$	TCK Clock LOW to TDO Valid	–	10	ns
$t_{TDOX}$	TCK Clock LOW to TDO Invalid	0	–	ns
<b>Setup Times</b>				
$t_{TMSS}$	TMS Setup to TCK Clock Rise	5	–	ns
$t_{TDIS}$	TDI Setup to TCK Clock Rise	5	–	ns
$t_{CS}$	Capture Setup to TCK Rise	5	–	ns
<b>Hold Times</b>				
$t_{TMSH}$	TMS Hold after TCK Clock Rise	5	–	ns
$t_{TDIH}$	TDI Hold after Clock Rise	5	–	ns
$t_{CH}$	Capture Hold after Clock Rise	5	–	ns

### Notes

15.  $t_{CS}$  and  $t_{CH}$  refer to the setup and hold time requirements of latching data from the boundary scan register.

16. Test conditions are specified using the load in TAP AC test conditions.  $t_R/t_F = 1$  ns.

### 3.3 V TAP AC Test Conditions

Input pulse levels .....  $V_{SS}$  to 3.3 V  
 Input rise and fall times ..... 1 ns  
 Input timing reference levels ..... 1.5 V  
 Output reference levels ..... 1.5 V  
 Test load termination supply voltage ..... 1.5 V

### 3.3 V TAP AC Output Load Equivalent

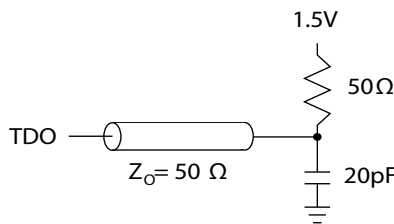

### 2.5 V TAP AC Test Conditions

Input pulse levels .....  $V_{SS}$  to 2.5 V  
 Input rise and fall time ..... 1 ns  
 Input timing reference levels ..... 1.25 V  
 Output reference levels ..... 1.25 V  
 Test load termination supply voltage ..... 1.25 V

### 2.5 V TAP AC Output Load Equivalent

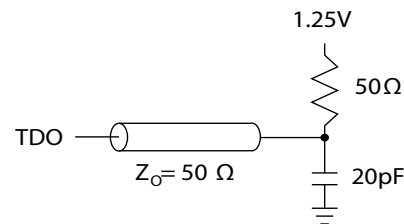

## TAP DC Electrical Characteristics and Operating Conditions

(0 °C < T<sub>A</sub> < +70 °C; V<sub>DD</sub> = 3.3 V ± 0.165 V unless otherwise noted)

Parameter <sup>[17]</sup>	Description	Test Conditions		Min	Max	Unit
V <sub>OH1</sub>	Output HIGH Voltage	I <sub>OH</sub> = -4.0 mA	V <sub>DDQ</sub> = 3.3 V	2.4	-	V
		I <sub>OH</sub> = -1.0 mA	V <sub>DDQ</sub> = 2.5 V	2.0	-	V
V <sub>OH2</sub>	Output HIGH Voltage	I <sub>OH</sub> = -100 μA	V <sub>DDQ</sub> = 3.3 V	2.9	-	V
			V <sub>DDQ</sub> = 2.5 V	2.1	-	V
V <sub>OL1</sub>	Output LOW Voltage	I <sub>OL</sub> = 8.0 mA	V <sub>DDQ</sub> = 3.3 V	-	0.4	V
		I <sub>OL</sub> = 8.0 mA	V <sub>DDQ</sub> = 2.5 V	-	0.4	V
V <sub>OL2</sub>	Output LOW Voltage	I <sub>OL</sub> = 100 μA	V <sub>DDQ</sub> = 3.3 V	-	0.2	V
			V <sub>DDQ</sub> = 2.5 V	-	0.2	V
V <sub>IH</sub>	Input HIGH Voltage		V <sub>DDQ</sub> = 3.3 V	2.0	V <sub>DD</sub> + 0.3	V
			V <sub>DDQ</sub> = 2.5 V	1.7	V <sub>DD</sub> + 0.3	V
V <sub>IL</sub>	Input LOW Voltage		V <sub>DDQ</sub> = 3.3 V	-0.3	0.8	V
			V <sub>DDQ</sub> = 2.5 V	-0.3	0.7	V
I <sub>X</sub>	Input Load Current	GND ≤ V <sub>IN</sub> ≤ V <sub>DDQ</sub>		-5	5	μA

**Note**  
 17. All voltages referenced to V<sub>SS</sub> (GND).

## Identification Register Definitions

Instruction Field	CY7C1381D (512K x 36)	CY7C1383F (1M x 18)	Description
Revision Number (31:29)	000	000	Describes the version number.
Device Depth (28:24) <sup>[18]</sup>	01011	01011	Reserved for internal use.
Device Width (23:18) 165-ball FBGA	000001	000001	Defines the memory type and architecture.
Cypress Device ID (17:12)	100101	010101	Defines the width and density.
Cypress JEDEC ID Code (11:1)	00000110100	00000110100	Allows unique identification of SRAM vendor.
ID Register Presence Indicator (0)	1	1	Indicates the presence of an ID register.

## Scan Register Sizes

Register Name	Bit Size (x 36)	Bit Size (x 18)
Instruction Bypass	3	3
Bypass	1	1
ID	32	32
Boundary Scan Order (165-ball FBGA package)	89	89

## Instruction Codes

Instruction	Code	Description
EXTEST	000	Captures Input/Output ring contents. Places the boundary scan register between TDI and TDO. Forces all SRAM outputs to high Z state.
IDCODE	001	Loads the ID register with the vendor ID code and places the register between TDI and TDO. This operation does not affect SRAM operations.
SAMPLE Z	010	Captures Input/Output ring contents. Places the boundary scan register between TDI and TDO. Forces all SRAM output drivers to a high Z state.
RESERVED	011	Do Not Use. This instruction is reserved for future use.
SAMPLE/PRELOAD	100	Captures Input/Output ring contents. Places the boundary scan register between TDI and TDO. Does not affect SRAM operation.
RESERVED	101	Do Not Use. This instruction is reserved for future use.
RESERVED	110	Do Not Use. This instruction is reserved for future use.
BYPASS	111	Places the bypass register between TDI and TDO. This operation does not affect SRAM operations.

### Note

18. Bit #24 is "1" in the register definitions for both 2.5 V and 3.3 V versions of this device.

## Boundary Scan Order

165-ball FBGA [19, 20]

Bit #	Ball ID
1	N6
2	N7
3	N10
4	P11
5	P8
6	R8
7	R9
8	P9
9	P10
10	R10
11	R11
12	H11
13	N11
14	M11
15	L11
16	K11
17	J11
18	M10
19	L10
20	K10
21	J10
22	H9
23	H10
24	G11
25	F11
26	E11
27	D11
28	G10
29	F10
30	E10

Bit #	Ball ID
31	D10
32	C11
33	A11
34	B11
35	A10
36	B10
37	A9
38	B9
39	C10
40	A8
41	B8
42	A7
43	B7
44	B6
45	A6
46	B5
47	A5
48	A4
49	B4
50	B3
51	A3
52	A2
53	B2
54	C2
55	B1
56	A1
57	C1
58	D1
59	E1
60	F1

Bit #	Ball ID
61	G1
62	D2
63	E2
64	F2
65	G2
66	H1
67	H3
68	J1
69	K1
70	L1
71	M1
72	J2
73	K2
74	L2
75	M2
76	N1
77	N2
78	P1
79	R1
80	R2
81	P3
82	R3
83	P2
84	R4
85	P4
86	N5
87	P6
88	R6
89	Internal

**Notes**

 19. Balls which are NC (No Connect) are pre-set LOW.  
 20. Bit# 89 is pre-set HIGH.

## Maximum Ratings

Exceeding the maximum ratings may impair the useful life of the device. For user guidelines, not tested.

Storage Temperature ..... -65 °C to +150 °C

Ambient Temperature with Power Applied ..... -55 °C to +125 °C

Supply Voltage on V<sub>DD</sub> Relative to GND ..... -0.3 V to +4.6 V

Supply Voltage on V<sub>DDQ</sub> Relative to GND ..... -0.3 V to +V<sub>DD</sub>

DC Voltage Applied to Outputs in Tri-State ..... -0.5 V to V<sub>DDQ</sub> + 0.5 V

DC Input Voltage ..... -0.5 V to V<sub>DD</sub> + 0.5 V

Current into Outputs (LOW) ..... 20 mA

Static Discharge Voltage (per MIL-STD-883, Method 3015) ..... > 2001 V

Latch-up Current ..... > 200 mA

## Operating Range

Range	Ambient Temperature	V <sub>DD</sub>	V <sub>DDQ</sub>
Commercial	0 °C to +70 °C	3.3 V – 5% / + 10%	2.5 V – 5% to V <sub>DD</sub>
Industrial	-40 °C to +85 °C		

## Neutron Soft Error Immunity

Parameter	Description	Test Conditions	Typ	Max [21]	Unit
LSBU	Logical Single-Bit Upsets	25 °C	361	394	FIT/Mb
LMBU	Logical Multi-Bit Upsets	25 °C	0	0.01	FIT/Mb
SEL	Single Event Latch Up	85 °C	0	0.1	FIT/Dev

## Electrical Characteristics

Over the Operating Range

Parameter [22, 23]	Description	Test Conditions	Min	Max	Unit	
V <sub>DD</sub>	Power Supply Voltage		3.135	3.6	V	
V <sub>DDQ</sub>	I/O Supply Voltage	for 3.3 V I/O	3.135	V <sub>DD</sub>	V	
		for 2.5 V I/O	2.375	2.625	V	
V <sub>OH</sub>	Output HIGH Voltage	for 3.3 V I/O, I <sub>OH</sub> = -4.0 mA	2.4	-	V	
		for 2.5 V I/O, I <sub>OH</sub> = -1.0 mA	2.0	-	V	
V <sub>OL</sub>	Output LOW Voltage	for 3.3 V I/O, I <sub>OL</sub> = 8.0 mA	-	0.4	V	
		for 2.5 V I/O, I <sub>OL</sub> = 1.0 mA	-	0.4	V	
V <sub>IH</sub>	Input HIGH Voltage [22]	for 3.3 V I/O	2.0	V <sub>DD</sub> + 0.3 V	V	
		for 2.5 V I/O	1.7	V <sub>DD</sub> + 0.3 V	V	
V <sub>IL</sub>	Input LOW Voltage [22]	for 3.3 V I/O	-0.3	0.8	V	
		for 2.5 V I/O	-0.3	0.7	V	
I <sub>X</sub>	Input Leakage Current except ZZ and MODE	GND ≤ V <sub>I</sub> ≤ V <sub>DDQ</sub>	-5	5	μA	
	Input Current of MODE	Input = V <sub>SS</sub>	-30	-	μA	
		Input = V <sub>DD</sub>	-	5	μA	
	Input Current of ZZ	Input = V <sub>SS</sub>	-5	-	μA	
Input = V <sub>DD</sub>		-	30	μA		
I <sub>OZ</sub>	Output Leakage Current	GND ≤ V <sub>I</sub> ≤ V <sub>DD</sub> , Output Disabled	-5	5	μA	
I <sub>DD</sub>	V <sub>DD</sub> Operating Supply Current	V <sub>DD</sub> = Max, I <sub>OUT</sub> = 0 mA, f = f <sub>MAX</sub> = 1/t <sub>CYC</sub>	7.5 ns cycle, 133 MHz	-	210	mA
			10 ns cycle, 100 MHz	-	175	mA

### Notes

21. No LMBU or SEL events occurred during testing; this column represents a statistical c2, 95% confidence limit calculation. For more details refer to Application Note AN54908, Accelerated Neutron SER Testing and Calculation of Terrestrial Failure Rates.

22. Overshoot: V<sub>IH(AC)</sub> < V<sub>DD</sub> + 1.5 V (pulse width less than t<sub>CYC</sub>/2), undershoot: V<sub>IL(AC)</sub> > -2 V (pulse width less than t<sub>CYC</sub>/2).

23. T<sub>power up</sub>: Assumes a linear ramp from 0 V to V<sub>DD(min)</sub> within 200 ms. During this time V<sub>IH</sub> < V<sub>DD</sub> and V<sub>DDQ</sub> ≤ V<sub>DD</sub>.

## Electrical Characteristics *(continued)*

Over the Operating Range

Parameter <sup>[22, 23]</sup>	Description	Test Conditions	Min	Max	Unit	
I <sub>SB1</sub>	Automatic CE power-down Current – TTL Inputs	Max V <sub>DD</sub> , Device Deselected, V <sub>IN</sub> ≥ V <sub>IH</sub> or V <sub>IN</sub> ≤ V <sub>IL</sub> , f = f <sub>MAX</sub> , inputs switching	7.5 ns cycle, 133 MHz	–	140	mA
			10 ns cycle, 100 MHz	–	120	
I <sub>SB2</sub>	Automatic CE power-down Current – CMOS Inputs	Max V <sub>DD</sub> , Device Deselected, V <sub>IN</sub> ≥ V <sub>DD</sub> – 0.3 V or V <sub>IN</sub> ≤ 0.3 V, f = 0, inputs static	All speeds	–	70	mA
I <sub>SB3</sub>	Automatic CE power-down Current – CMOS Inputs	Max V <sub>DD</sub> , Device Deselected, V <sub>IN</sub> ≥ V <sub>DDQ</sub> – 0.3 V or V <sub>IN</sub> ≤ 0.3 V, f = f <sub>MAX</sub> , inputs switching	7.5 ns cycle, 133 MHz	–	130	mA
			10 ns cycle, 100 MHz	–	110	
I <sub>SB4</sub>	Automatic CE power-down Current – TTL Inputs	Max V <sub>DD</sub> , Device Deselected, V <sub>IN</sub> ≥ V <sub>DD</sub> – 0.3 V or V <sub>IN</sub> ≤ 0.3 V, f = 0, inputs static	All Speeds	–	80	mA

## Capacitance

Parameter <sup>[24]</sup>	Description	Test Conditions	100-pin TQFP Package	165-ball FBGA Package	Unit
C <sub>IN</sub>	Input capacitance	T <sub>A</sub> = 25 °C, f = 1 MHz, V <sub>DD</sub> = 3.3 V, V <sub>DDQ</sub> = 2.5 V	5	9	pF
C <sub>CLK</sub>	Clock input capacitance		5	9	pF
C <sub>IO</sub>	Input/Output capacitance		5	9	pF

## Thermal Resistance

Parameter <sup>[24]</sup>	Description	Test Conditions	100-pin TQFP Package	165-ball FBGA Package	Unit
Θ <sub>JA</sub>	Thermal resistance (junction to ambient)	Test conditions follow standard test methods and procedures for measuring thermal impedance, in accordance with EIA/JESD51.	28.66	20.7	°C/W
Θ <sub>JC</sub>	Thermal resistance (junction to case)		4.08	4.0	°C/W

### Note

24. Tested initially and after any design or process change that may affect these parameters.

## AC Test Loads and Waveforms

Figure 4. AC Test Loads and Waveforms

### 3.3 V I/O Test Load

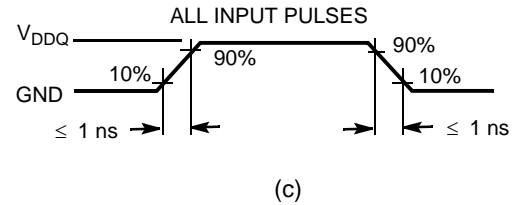
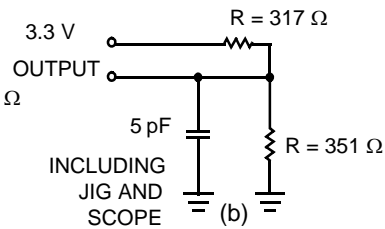
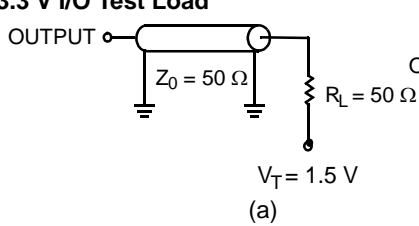

### 2.5 V I/O Test Load

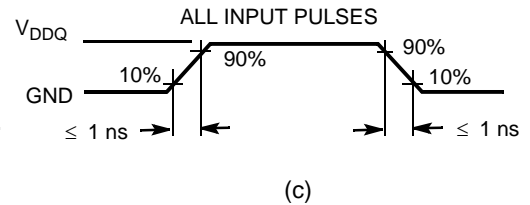
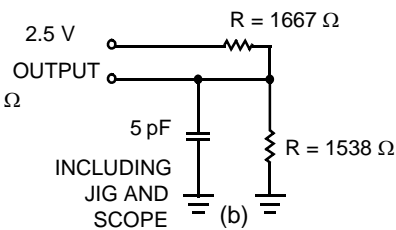
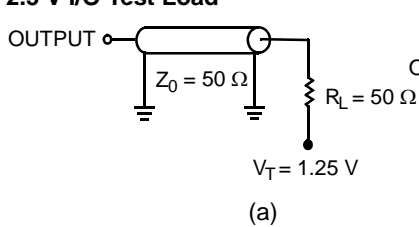

## Switching Characteristics

Over the Operating Range

Parameter <sup>[25, 26]</sup>	Description	133 MHz		100 MHz		Unit
		Min	Max	Min	Max	
t <sub>POWER</sub>	V <sub>DD</sub> (typical) to the first access <sup>[27]</sup>	1	–	1	–	ms
<b>Clock</b>						
t <sub>CYC</sub>	Clock cycle time	7.5	–	10	–	ns
t <sub>CH</sub>	Clock HIGH	2.1	–	2.5	–	ns
t <sub>CL</sub>	Clock LOW	2.1	–	2.5	–	ns
<b>Output Times</b>						
t <sub>CDV</sub>	Data output valid after CLK rise	–	6.5	–	8.5	ns
t <sub>DOH</sub>	Data output hold after CLK rise	2.0	–	2.0	–	ns
t <sub>CLZ</sub>	Clock to low Z <sup>[28, 29, 30]</sup>	2.0	–	2.0	–	ns
t <sub>CHZ</sub>	Clock to high Z <sup>[28, 29, 30]</sup>	0	4.0	0	5.0	ns
t <sub>OEV</sub>	$\overline{\text{OE}}$ LOW to output valid	–	3.2	–	3.8	ns
t <sub>OELZ</sub>	$\overline{\text{OE}}$ LOW to output low Z <sup>[28, 29, 30]</sup>	0	–	0	–	ns
t <sub>OEHZ</sub>	$\overline{\text{OE}}$ HIGH to output high Z <sup>[28, 29, 30]</sup>	–	4.0	–	5.0	ns
<b>Setup Times</b>						
t <sub>AS</sub>	Address setup before CLK rise	1.5	–	1.5	–	ns
t <sub>ADS</sub>	ADSP, ADSC setup before CLK rise	1.5	–	1.5	–	ns
t <sub>ADVS</sub>	$\overline{\text{ADV}}$ setup before CLK rise	1.5	–	1.5	–	ns
t <sub>WES</sub>	$\overline{\text{GW}}$ , $\overline{\text{BWE}}$ , $\overline{\text{BW}}_{[\text{A:D}]}$ setup before CLK rise	1.5	–	1.5	–	ns
t <sub>DS</sub>	Data input setup before CLK rise	1.5	–	1.5	–	ns
t <sub>CES</sub>	Chip enable setup	1.5	–	1.5	–	ns
<b>Hold Times</b>						
t <sub>AH</sub>	Address hold after CLK rise	0.5	–	0.5	–	ns
t <sub>ADH</sub>	ADSP, ADSC hold after CLK rise	0.5	–	0.5	–	ns
t <sub>WEH</sub>	$\overline{\text{GW}}$ , $\overline{\text{BWE}}$ , $\overline{\text{BW}}_{[\text{A:D}]}$ hold after CLK rise	0.5	–	0.5	–	ns
t <sub>ADVH</sub>	$\overline{\text{ADV}}$ hold after CLK rise	0.5	–	0.5	–	ns
t <sub>DH</sub>	Data input hold after CLK rise	0.5	–	0.5	–	ns
t <sub>CEH</sub>	Chip enable hold after CLK rise	0.5	–	0.5	–	ns

### Notes

25. Timing reference level is 1.5 V when V<sub>DDQ</sub> = 3.3 V and is 1.25 V when V<sub>DDQ</sub> = 2.5 V.

26. Test conditions shown in (a) of [Figure 4 on page 22](#) unless otherwise noted.

27. This part has a voltage regulator internally; t<sub>POWER</sub> is the time that the power needs to be supplied above V<sub>DD(minimum)</sub> initially, before a read or write operation can be initiated.

28. t<sub>CHZ</sub>, t<sub>CLZ</sub>, t<sub>OELZ</sub>, and t<sub>OEHZ</sub> are specified with AC test conditions shown in part (b) of [Figure 4 on page 22](#). Transition is measured ±200 mV from steady-state voltage

29. At any given voltage and temperature, t<sub>OEHZ</sub> is less than t<sub>OELZ</sub> and t<sub>CHZ</sub> is less than t<sub>CLZ</sub> to eliminate bus contention between SRAMs when sharing the same data bus. These specifications do not imply a bus contention condition, but reflect parameters guaranteed over worst case user conditions. Device is designed to achieve high Z prior to low Z under the same system condition.

30. This parameter is sampled and not 100% tested.

## Timing Diagrams

Figure 5. Read Cycle Timing <sup>[31]</sup>

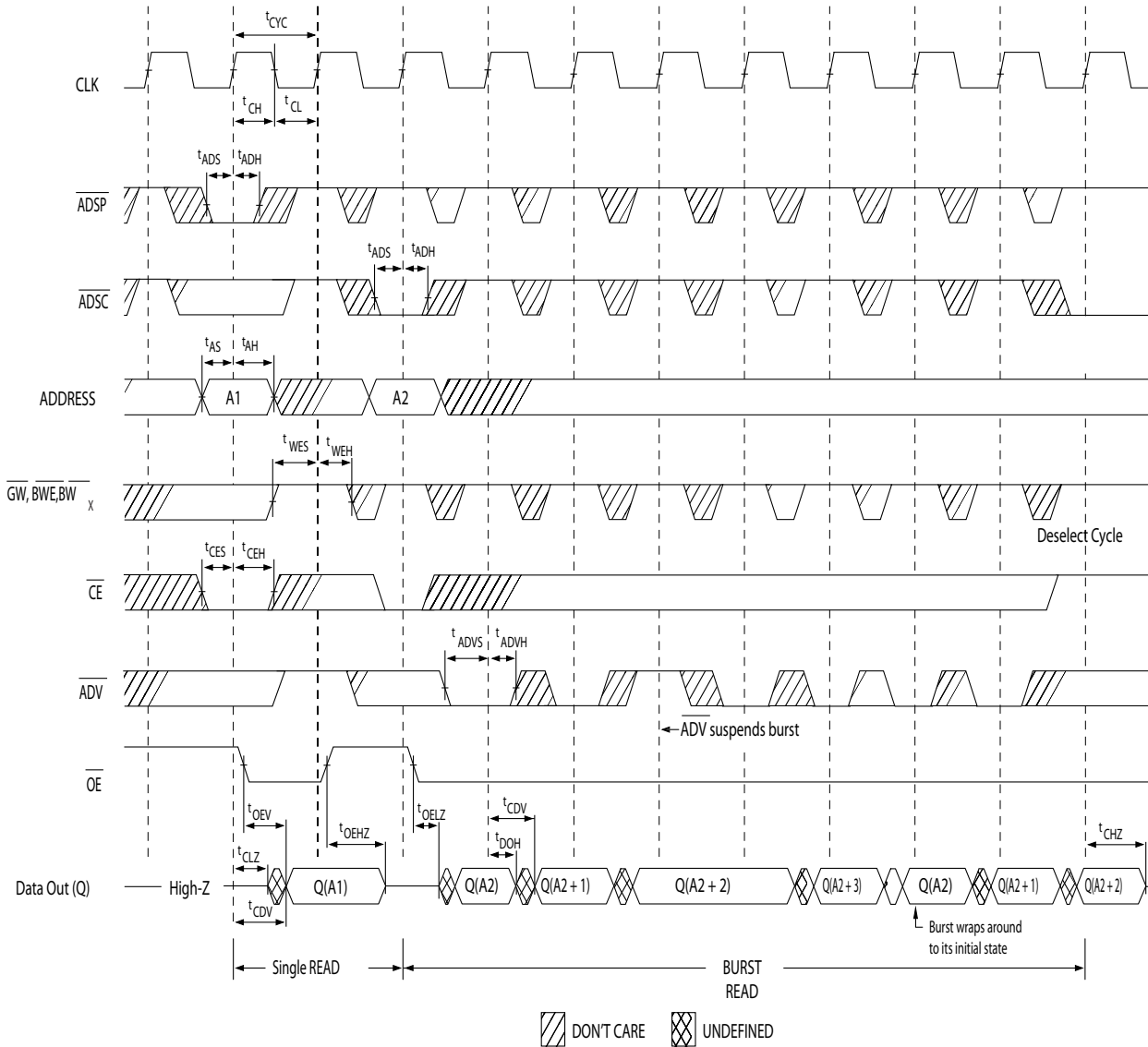

**Note**

31. When  $\overline{CE}$  is LOW,  $\overline{CE}_1$  is LOW,  $CE_2$  is HIGH and  $\overline{CE}_3$  is LOW. When  $\overline{CE}$  is HIGH,  $\overline{CE}_1$  is HIGH or  $CE_2$  is LOW or  $\overline{CE}_3$  is HIGH.

Timing Diagrams (continued)

Figure 6. Write Cycle Timing [32, 33]

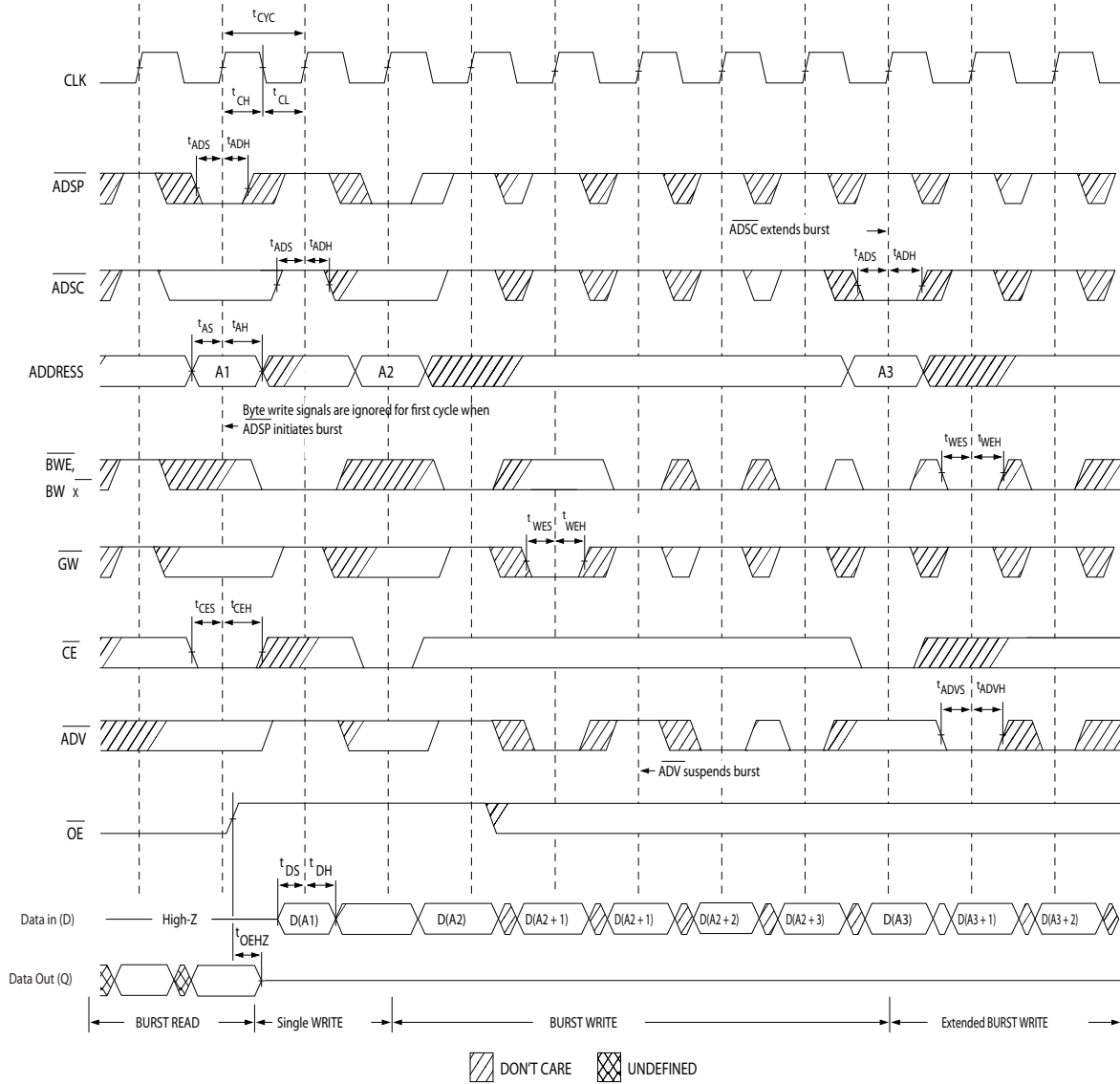

Notes

- 32. When  $\overline{CE}$  is LOW,  $\overline{CE}_1$  is LOW,  $CE_2$  is HIGH and  $\overline{CE}_3$  is LOW. When  $\overline{CE}$  is HIGH,  $\overline{CE}_1$  is HIGH or  $CE_2$  is LOW or  $\overline{CE}_3$  is HIGH.
- 33. Full width write can be initiated by either  $\overline{GW}$  LOW; or by  $\overline{GW}$  HIGH,  $\overline{BWE}$  LOW and  $\overline{BW}_x$  LOW.

Timing Diagrams (continued)

Figure 7. Read/Write Cycle Timing [34, 35, 36]

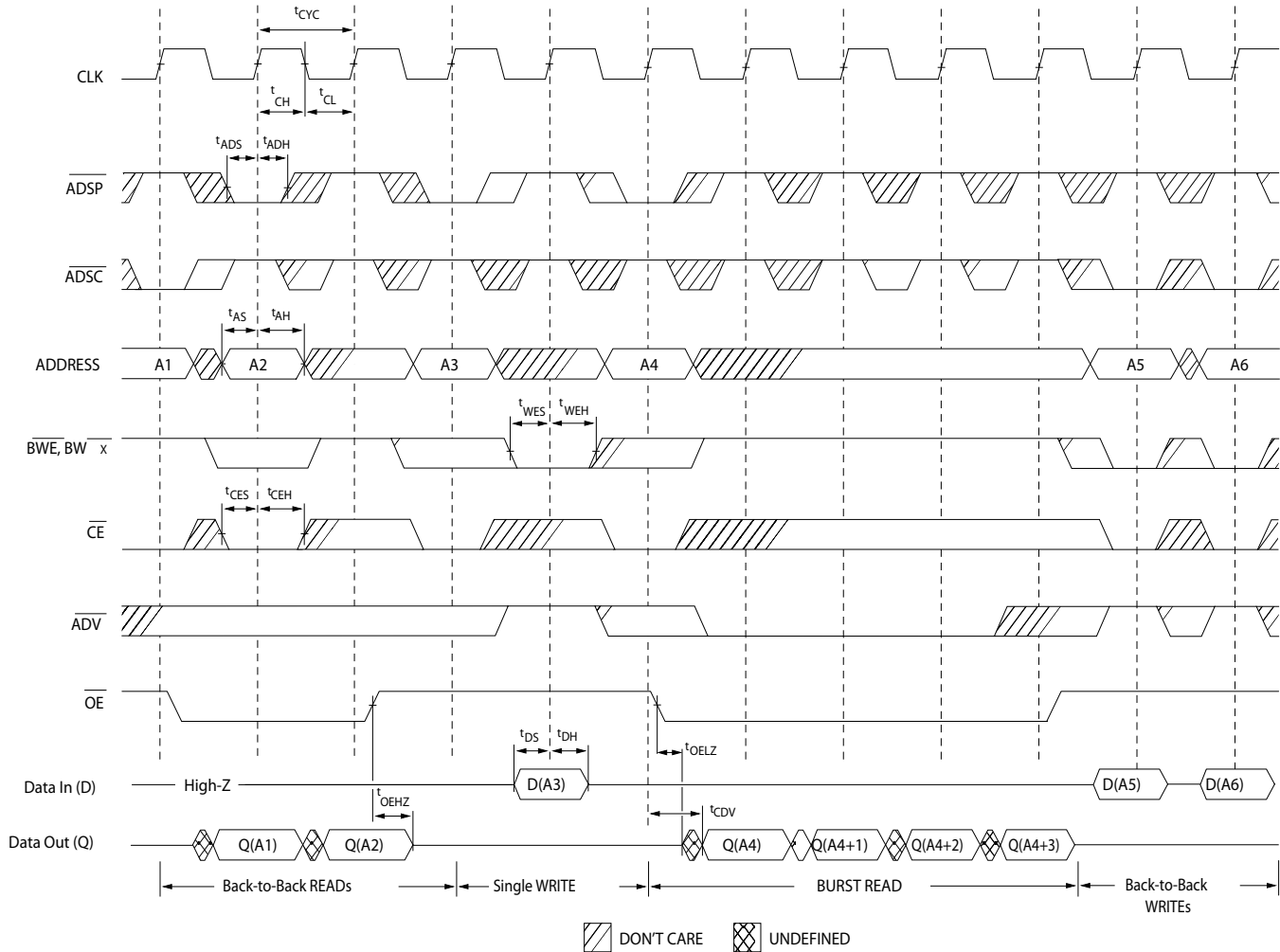

Notes

34. When  $\overline{CE}$  is LOW,  $\overline{CE}_1$  is LOW,  $CE_2$  is HIGH and  $\overline{CE}_3$  is LOW. When  $\overline{CE}$  is HIGH,  $\overline{CE}_1$  is HIGH or  $CE_2$  is LOW or  $\overline{CE}_3$  is HIGH.  
 35. The data bus (Q) remains in high Z following a WRITE cycle, unless a new read access is initiated by ADSP or ADSC.  
 36. GW is HIGH.

**Timing Diagrams** (continued)

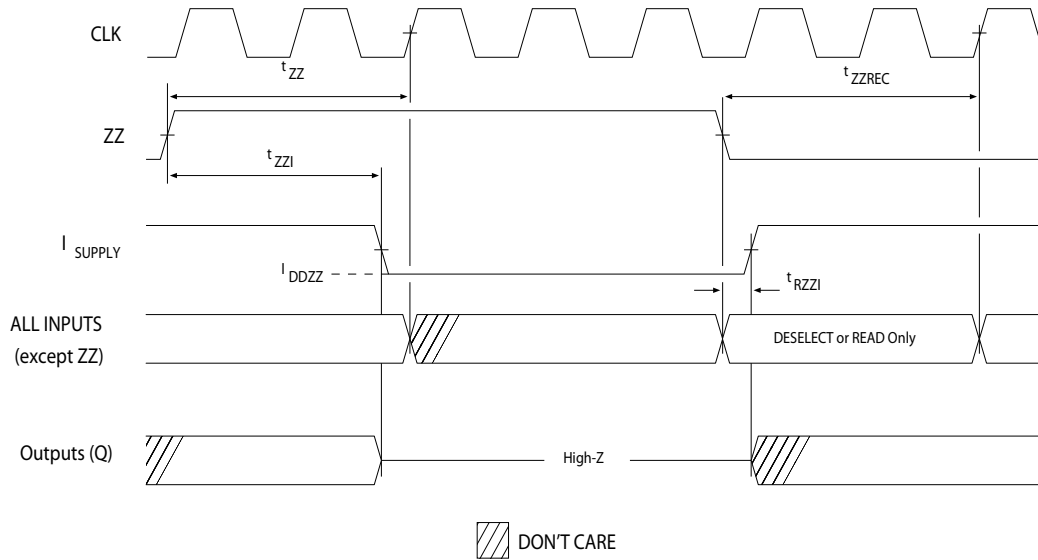
**Figure 8. ZZ Mode Timing** [37, 38]

**Notes**

37. Device must be deselected when entering ZZ mode. See [Truth Table](#) on page 10 for all possible signal conditions to deselect the device.  
 38. DQs are in high Z when exiting ZZ sleep mode.

## Ordering Information

Cypress offers other versions of this type of product in many different configurations and features. The below table contains only the list of parts that are currently available. For a complete listing of all options, visit the Cypress website at [www.cypress.com](http://www.cypress.com) and refer to the product summary page at <http://www.cypress.com/products> or contact your local sales representative. Cypress maintains a worldwide network of offices, solution centers, manufacturer's representatives and distributors. To find the office closest to you, visit us at <http://www.cypress.com/go/datasheet/offices>.

Speed (MHz)	Ordering Code	MPN Status	Package Diagram	Part and Package Type	Operating Range
133	CY7C1381D-133AXC <sup>[39]</sup>	NRND	51-85050	100-pin TQFP (14 x 20 x 1.4 mm) Pb-free	Commercial
	CY7C1383D-133AXC <sup>[39]</sup>				
	CY7C1381D-133AXI <sup>[39]</sup>				Industrial
	CY7C1383D-133AXI <sup>[39]</sup>				
100	CY7C1381D-100AXC <sup>[39]</sup>	NRND	51-85050	100-pin TQFP (14 x 20 x 1.4 mm) Pb-free	Commercial
	CY7C1381D-100BZI <sup>[39]</sup>		51-85180	165-ball FBGA (13 x 15 x 1.4 mm)	Industrial
	CY7C1381D-100BZXI <sup>[39]</sup>			165-ball FBGA (13 x 15 x 1.4 mm) Pb-free	

## Ordering Code Definitions

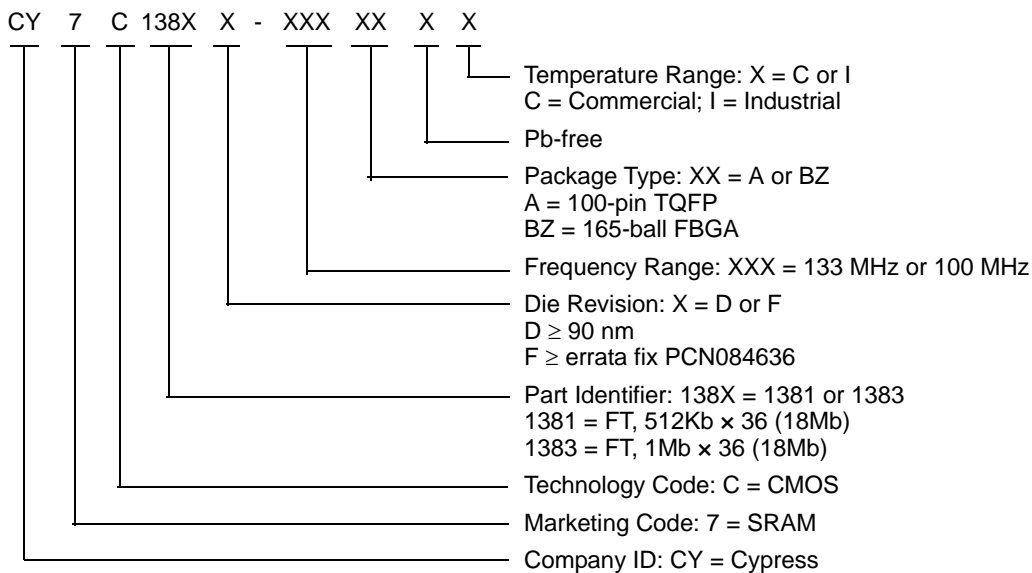

### Note

<sup>39</sup>. These MPNs are not recommended for new designs.



Package Diagrams (continued)

Figure 10. 165-ball FBGA (13 × 15 × 1.4 mm) BB165D/BW165D (0.5 Ball Diameter) Package Outline, 51-85180

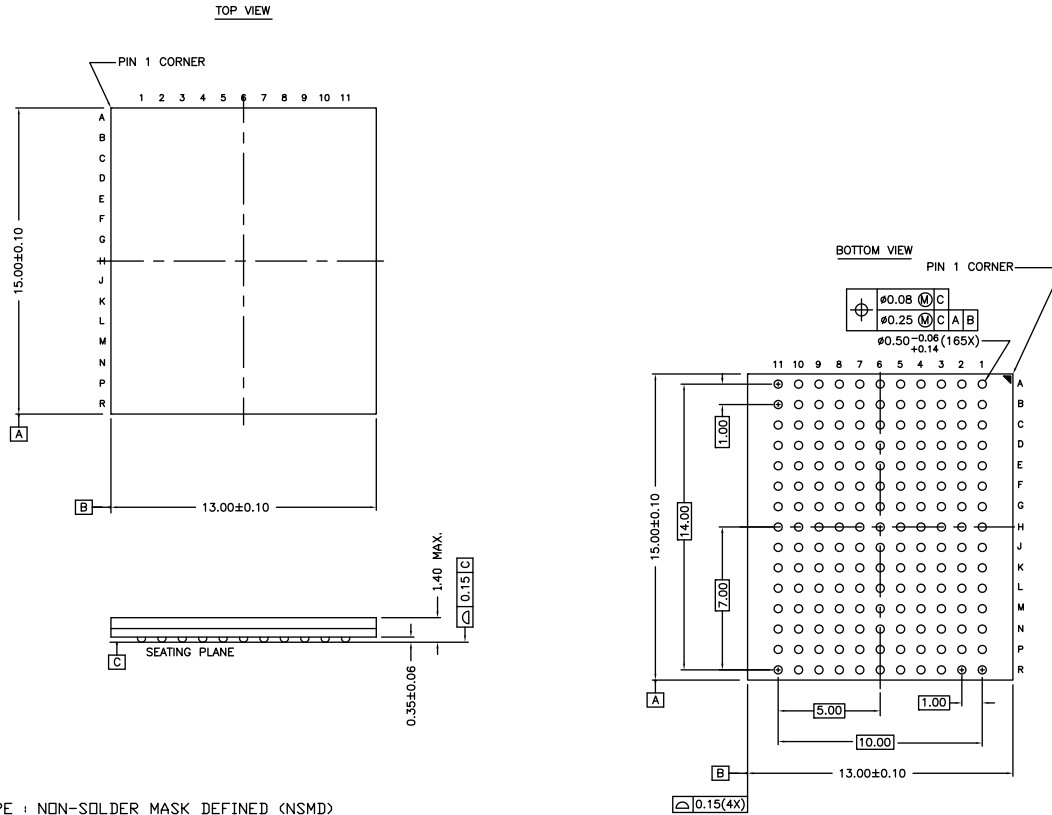

NOTES :

SOLDER PAD TYPE : NON-SOLDER MASK DEFINED (NSMD)

JEDEC REFERENCE : MO-216 / ISSUE E

PACKAGE CODE : BB0AC/BW0AC

PACKAGE WEIGHT : SEE CYPRESS PACKAGE MATERIAL DECLARATION DATASHEET (PMDD) POSTED ON THE CYPRESS WEB.

51-85180 \*G

## Acronyms

Acronym	Description
CE	Chip Enable
CMOS	Complementary Metal Oxide Semiconductor
EIA	Electronic Industries Alliance
FBGA	Fine-Pitch Ball Grid Array
I/O	Input/Output
JEDEC	Joint Electron Devices Engineering Council
JTAG	Joint Test Action Group
LMBU	Logical Multi-Bit Upsets
LSB	Least Significant Bit
LSBU	Logical Single-Bit Upsets
MSB	Most Significant Bit
$\overline{OE}$	Output Enable
SEL	Single Event Latch Up
SRAM	Static Random Access Memory
TAP	Test Access Port
TCK	Test Clock
TDI	Test Data-In
TDO	Test Data-Out
TMS	Test Mode Select
TQFP	Thin Quad Flat Pack
TTL	Transistor-Transistor Logic

## Document Conventions

### Units of Measure

Symbol	Unit of Measure
°C	degree Celsius
MHz	megahertz
μA	microampere
mA	milliampere
mm	millimeter
ms	millisecond
mV	millivolt
ns	nanosecond
Ω	ohm
%	percent
pF	picofarad
V	volt
W	watt

## Errata

This section describes the Ram9 Sync ZZ pin and JTAG issues. Details include trigger conditions, the devices affected, proposed workaround and silicon revision applicability. Please contact your local Cypress sales representative if you have further questions.

### Part Numbers Affected

Density & Revision	Package Type	Operating Range
18Mb-Ram9 Synchronous SRAMs: CY7C138*D, CY7C138*F	100-pin TQFP	Commercial/ Industrial
	165-ball FBGA	Industrial

### Product Status

All of the devices in the Ram9 18Mb Sync family are qualified and available in production quantities.

### Ram9 Sync ZZ Pin & JTAG Issues Errata Summary

The following table defines the errata applicable to available Ram9 18Mb Sync family devices.

Item	Issues	Description	Device	Fix Status
1.	ZZ Pin	When asserted HIGH, the ZZ pin places device in a "sleep" condition with data integrity preserved. The ZZ pin currently does not have an internal pull-down resistor and hence cannot be left floating externally by the user during normal mode of operation.	18M-Ram9 (90 nm)	For the 18M Ram9 (90 nm) devices, there is no plan to fix this issue.
2.	JTAG Functionality	During JTAG test mode, the Boundary scan circuitry does not perform as described in the datasheet. However, it is possible to perform the JTAG test with these devices in "BYPASS mode".	18M-Ram9 (90 nm)	This issue will be fixed in the new revision, which use the 65 nm technology. Please contact your local sales rep for availability.

## 1. ZZ Pin Issue

### ■ PROBLEM DEFINITION

The problem occurs only when the device is operated in the normal mode with ZZ pin left floating. The ZZ pin on the SRAM device does not have an internal pull-down resistor. Switching noise in the system may cause the SRAM to recognize a HIGH on the ZZ input, which may cause the SRAM to enter sleep mode. This could result in incorrect or undesirable operation of the SRAM.

### ■ TRIGGER CONDITIONS

Device operated with ZZ pin left floating.

### ■ SCOPE OF IMPACT

When the ZZ pin is left floating, the device delivers incorrect data.

### ■ WORKAROUND

Tie the ZZ pin externally to ground.

### ■ FIX STATUS

For the 18M Ram9 (90 nm) devices, there is no plan to fix this issue.

## 2. JTAG Functionality

### ■ PROBLEM DEFINITION

The problem occurs only when the device is operated in the JTAG test mode. During this mode, the JTAG circuitry can perform incorrectly by delivering the incorrect data or the incorrect scan chain length.

### ■ TRIGGER CONDITIONS

Several conditions can trigger this failure mode.

1. The device can deliver an incorrect length scan chain when operating in JTAG mode.
2. Some Byte Write inputs only recognize a logic HIGH level when in JTAG mode.
3. Incorrect JTAG data can be read from the device when the ZZ input is tied HIGH during JTAG operation.

### ■ SCOPE OF IMPACT

The device fails for JTAG test. This does not impact the normal functionality of the device.

### ■ WORKAROUND

1. Perform JTAG testing with these devices in "BYPASS mode".
2. Do not use JTAG test.

### ■ FIX STATUS

This issue will be fixed in the new revision, which use the 65 nm technology. Please contact your local sales rep for availability.

## Document History Page

Document Title: CY7C1381D/CY7C1383D/CY7C1383F, 18-Mbit (512K × 36/1M × 18) Flow-Through SRAM				
Document Number: 38-05544				
Rev.	ECN No.	Orig. of Change	Submission Date	Description of Change
**	254518	RKF	See ECN	New data sheet.
*A	288531	SYT	See ECN	Updated <a href="#">Features</a> (Removed 117 MHz speed bin). Updated <a href="#">Selection Guide</a> (Removed 117 MHz speed bin). Updated <a href="#">IEEE 1149.1 Serial Boundary Scan (JTAG [14])</a> (Edited description for non-compliance with 1149.1) Updated <a href="#">Electrical Characteristics</a> (Removed 117 MHz speed bin). Updated <a href="#">Switching Characteristics</a> (Removed 117 MHz speed bin). Updated <a href="#">Ordering Information</a> (Added Pb-free information for 100-pin TQFP, 119-ball BGA and 165-ball FBGA package) and added comment of 'Pb-free BG packages availability' below the Ordering Information.
*B	326078	PCI	See ECN	Changed status from Preliminary to Final. Updated <a href="#">Pin Configurations</a> (Address expansion pins/balls in the pinouts for all packages are modified as per JEDEC standard). Updated <a href="#">TAP Instruction Set</a> (Changed description of <a href="#">OVERVIEW</a> and <a href="#">EXTTEST</a> sub-sections, added a sub-section <a href="#">EXTTEST Output Bus Tri-State</a> ). Updated <a href="#">Identification Register Definitions</a> (Splitted Device Width (23:18) row into two rows Device Width (23:18) 119-ball BGA and another row Device Width (23:18) 165-ball FBGA). Updated <a href="#">Electrical Characteristics</a> (Modified test conditions for $V_{OL}$ , $V_{OH}$ parameters). Updated <a href="#">Thermal Resistance</a> (Changed $\theta_{JA}$ for 100-pin TQFP Package from 31 °C/W to 28.66 °C/W, changed $\theta_{JC}$ for 100-pin TQFP Package from 6 °C/W to 4.08 °C/W, changed $\theta_{JA}$ for 119-ball BGA Package from 45 °C/W to 23.8 °C/W, changed $\theta_{JC}$ for 119-ball BGA Package from 7 °C/W to 6.2 °C/W, changed $\theta_{JA}$ for 165-ball FBGA Package from 46 °C/W to 20.7 °C/W, changed $\theta_{JC}$ for 165-ball FBGA Package from 3 °C/W to 4.0 °C/W). Updated <a href="#">Ordering Information</a> (Updated part numbers) and removed comment of 'Pb-free BG packages availability' below the Ordering Information.
*C	351895	PCI	See ECN	Updated <a href="#">Ordering Information</a> (Updated part numbers).
*D	416321	NXR	See ECN	Changed address of Cypress Semiconductor Corporation on Page# 1 from "3901 North First Street" to "198 Champion Court" Updated <a href="#">Electrical Characteristics</a> (Changed description of $I_X$ parameter from Input Load Current to Input Leakage Current, changed the minimum value of $I_X$ parameter corresponding to Input Current of MODE from -5 µA to -30 µA, changed the maximum value of $I_X$ parameter corresponding to Input Current of MODE from 30 µA to 5 µA, changed the minimum value of $I_X$ parameter corresponding to Input Current of ZZ from -30 µA to -5 µA, changed the minimum value of $I_X$ parameter corresponding to Input Current of ZZ from 5 µA to 30 µA, Changed $V_{IH} \leq V_{DD}$ to $V_{IH} < V_{DD}$ in Note 23). Updated <a href="#">Ordering Information</a> (Updated part numbers) and replaced Package Name column with Package Diagram in the Ordering Information table.
*E	475009	VKN	See ECN	Updated <a href="#">TAP AC Switching Characteristics</a> (Changed the minimum values of $t_{TH}$ , $t_{TL}$ parameters from 25 ns to 20 ns and changed the maximum value of $t_{TDOV}$ parameter from 5 ns to 10 ns). Updated <a href="#">Maximum Ratings</a> (Added the Maximum Rating for Supply Voltage on $V_{DDQ}$ Relative to GND). Updated <a href="#">Ordering Information</a> (Updated part numbers).
*F	776456	VKN	See ECN	Added part numbers CY7C1381F and CY7C1383F and its related information. Added Note 1 regarding Chip Enable. Updated <a href="#">Ordering Information</a> (Updated part numbers).

**Document History Page** *(continued)*

Document Title: CY7C1381D/CY7C1383D/CY7C1383F, 18-Mbit (512K x 36/1M x 18) Flow-Through SRAM				
Document Number: 38-05544				
Rev.	ECN No.	Orig. of Change	Submission Date	Description of Change
*G	2752731	VKN / PYRS	08/17/09	Added <a href="#">Neutron Soft Error Immunity</a> . Updated <a href="#">Ordering Information</a> (By including parts that are available) and modified the disclaimer for the Ordering information.
*H	2897182	NJY	03/22/2010	Updated <a href="#">Ordering Information</a> (Removed inactive parts). Updated <a href="#">Package Diagrams</a> .
*I	3159479	NJY	02/01/2011	Updated <a href="#">Package Diagrams</a> . Added <a href="#">Acronyms</a> and <a href="#">Units of Measure</a> . Minor edits. Updated to new template.
*J	3192403	NJY	03/10/2011	Updated to new template.
*K	3210400	NJY	03/30/2011	Updated <a href="#">Ordering Information</a> (Removed pruned part CY7C1381F-133BGC).
*L	3440174	NJY	11/16/2011	Updated <a href="#">Ordering Information</a> (Added two part numbers CY7C1383D-133AXC and CY7C1383D-133AXI).
*M	3489571	NJY	01/10/2012	Updated <a href="#">Ordering Information</a> (Added part number CY7C1383F-133BZI). Updated <a href="#">Package Diagrams</a> .
*N	3578427	PRIT	04/11/2012	Updated <a href="#">Features</a> (Removed CY7C1381F related information, removed 119-ball BGA package related information, removed 165-ball FBGA package related information for CY7C1383D, added 165-ball FBGA package related information for CY7C1383F). Updated <a href="#">Functional Description</a> (Removed CY7C1381F related information, removed the Note "For best practices or recommendations, refer to the Cypress application note AN1064, <i>SRAM System Design Guidelines</i> on <a href="http://www.cypress.com">www.cypress.com</a> ." and its reference, removed the Note "CE <sub>3</sub> , CE <sub>2</sub> are for 100-pin TQFP and 165-ball FBGA packages only. 119-ball BGA is offered only in 1 chip enable."). Updated <a href="#">Logic Block Diagram – CY7C1381D</a> (Removed CY7C1381F related information). Updated <a href="#">Pin Configurations</a> (Removed CY7C1381F related information, removed 119-ball BGA package related information, removed 165-ball FBGA package related information for CY7C1383D, added 165-ball FBGA package related information for CY7C1383F). Updated <a href="#">Pin Definitions</a> (Removed the Note "CE <sub>3</sub> , CE <sub>2</sub> are for 100-pin TQFP and 165-ball FBGA packages only. 119-ball BGA is offered only in 1 chip enable." and its reference). Updated <a href="#">Functional Overview</a> (Removed CY7C1381F related information, removed the Note "CE <sub>3</sub> , CE <sub>2</sub> are for 100-pin TQFP and 165-ball FBGA packages only. 119-ball BGA is offered only in 1 chip enable." and its reference). Updated <a href="#">Truth Table</a> (Removed CY7C1381F related information). Updated <a href="#">Truth Table for Read/Write</a> (Removed CY7C1381F related information). Updated <a href="#">IEEE 1149.1 Serial Boundary Scan (JTAG [14])</a> (Removed CY7C1381F and CY7C1383D related information). Updated <a href="#">Identification Register Definitions</a> (Removed CY7C1381F and CY7C1383D related information, removed 119-ball BGA package related information). Updated <a href="#">Scan Register Sizes</a> (Removed 119-ball BGA package related information). Removed Boundary Scan Order (Corresponding to 119-ball BGA package). Updated <a href="#">Capacitance</a> (Removed 119-ball BGA package related information). Updated <a href="#">Thermal Resistance</a> (Removed 119-ball BGA package related information).

**Document History Page** *(continued)*

Document Title: CY7C1381D/CY7C1383D/CY7C1383F, 18-Mbit (512K x 36/1M x 18) Flow-Through SRAM Document Number: 38-05544				
Rev.	ECN No.	Orig. of Change	Submission Date	Description of Change
*N (cont.)	3578427	PRIT	04/11/2012	Updated <a href="#">Package Diagrams</a> (Removed 119-ball BGA package related information).
*O	3945784	PRIT	03/27/2013	Updated <a href="#">Package Diagrams</a> : spec 51-85180 – Changed revision from *E to *F.
*P	3977530	PRIT	04/22/2013	Added <a href="#">Errata</a> .
*Q	4068739	PRIT	07/20/2013	Added Errata footnotes (Note 2, 3, 4, 5, 6, 14). Updated <a href="#">Pin Configurations</a> : Added Note 2 and referred the same note in <a href="#">Figure 1</a> . Added Note 3, 4 and referred the same note in <a href="#">Figure 2</a> . Updated <a href="#">Pin Definitions</a> : Added Note 5 and referred the same note in ZZ pin. Added Note 6 and referred the same note in TDO, TDI, TMS, TCK pins. Updated <a href="#">IEEE 1149.1 Serial Boundary Scan (JTAG [14])</a> : Added Note 14 and referred the same note in JTAG in the heading. Updated <a href="#">Errata</a> . Updated to new template.
*R	4150971	PRIT	10/08/2013	Updated <a href="#">Errata</a> .
*S	4572829	PRIT	11/18/2014	Updated <a href="#">Functional Description</a> : Added “For a complete list of related documentation, click <a href="#">here</a> .” at the end. Updated <a href="#">Ordering Information</a> : Removed pruned part CY7C1470V25-167BZC.
*T	4739641	PRIT	04/24/2015	Updated to new template. Completing Sunset Review.
*U	5190429	PRIT	03/25/2016	Added watermark “Not Recommended for New Designs.” across the document. Updated <a href="#">Ordering Information</a> : Updated part numbers. Added a column “MPN Status”. Added Note 39 and referred the same note in all MPNs. Updated <a href="#">Package Diagrams</a> : spec 51-85180 – Changed revision from *F to *G. Updated to new template. Completing Sunset Review.
*V	5765371	AJU	06/07/2017	Updated Truth table Updated 100-pin TQFP package diagram.



## Sales, Solutions, and Legal Information

### Worldwide Sales and Design Support

Cypress maintains a worldwide network of offices, solution centers, manufacturer's representatives, and distributors. To find the office closest to you, visit us at [Cypress Locations](#).

#### Products

ARM® Cortex® Microcontrollers	<a href="http://cypress.com/arm">cypress.com/arm</a>
Automotive	<a href="http://cypress.com/automotive">cypress.com/automotive</a>
Clocks & Buffers	<a href="http://cypress.com/clocks">cypress.com/clocks</a>
Interface	<a href="http://cypress.com/interface">cypress.com/interface</a>
Internet of Things	<a href="http://cypress.com/iot">cypress.com/iot</a>
Memory	<a href="http://cypress.com/memory">cypress.com/memory</a>
Microcontrollers	<a href="http://cypress.com/mcu">cypress.com/mcu</a>
PSoC	<a href="http://cypress.com/psoc">cypress.com/psoc</a>
Power Management ICs	<a href="http://cypress.com/pmic">cypress.com/pmic</a>
Touch Sensing	<a href="http://cypress.com/touch">cypress.com/touch</a>
USB Controllers	<a href="http://cypress.com/usb">cypress.com/usb</a>
Wireless Connectivity	<a href="http://cypress.com/wireless">cypress.com/wireless</a>

#### PSoC® Solutions

[PSoC 1](#) | [PSoC 3](#) | [PSoC 4](#) | [PSoC 5LP](#) | [PSoC 6](#)

#### Cypress Developer Community

[Forums](#) | [WICED IOT Forums](#) | [Projects](#) | [Video](#) | [Blogs](#) | [Training](#) | [Components](#)

#### Technical Support

[cypress.com/support](http://cypress.com/support)

---

© Cypress Semiconductor Corporation, 2004-2017. This document is the property of Cypress Semiconductor Corporation and its subsidiaries, including Spansion LLC ("Cypress"). This document, including any software or firmware included or referenced in this document ("Software"), is owned by Cypress under the intellectual property laws and treaties of the United States and other countries worldwide. Cypress reserves all rights under such laws and treaties and does not, except as specifically stated in this paragraph, grant any license under its patents, copyrights, trademarks, or other intellectual property rights. If the Software is not accompanied by a license agreement and you do not otherwise have a written agreement with Cypress governing the use of the Software, then Cypress hereby grants you a personal, non-exclusive, nontransferable license (without the right to sublicense) (1) under its copyright rights in the Software (a) for Software provided in source code form, to modify and reproduce the Software solely for use with Cypress hardware products, only internally within your organization, and (b) to distribute the Software in binary code form externally to end users (either directly or indirectly through resellers and distributors), solely for use on Cypress hardware product units, and (2) under those claims of Cypress's patents that are infringed by the Software (as provided by Cypress, unmodified) to make, use, distribute, and import the Software solely for use with Cypress hardware products. Any other use, reproduction, modification, translation, or compilation of the Software is prohibited.

TO THE EXTENT PERMITTED BY APPLICABLE LAW, CYPRESS MAKES NO WARRANTY OF ANY KIND, EXPRESS OR IMPLIED, WITH REGARD TO THIS DOCUMENT OR ANY SOFTWARE OR ACCOMPANYING HARDWARE, INCLUDING, BUT NOT LIMITED TO, THE IMPLIED WARRANTIES OF MERCHANTABILITY AND FITNESS FOR A PARTICULAR PURPOSE. To the extent permitted by applicable law, Cypress reserves the right to make changes to this document without further notice. Cypress does not assume any liability arising out of the application or use of any product or circuit described in this document. Any information provided in this document, including any sample design information or programming code, is provided only for reference purposes. It is the responsibility of the user of this document to properly design, program, and test the functionality and safety of any application made of this information and any resulting product. Cypress products are not designed, intended, or authorized for use as critical components in systems designed or intended for the operation of weapons, weapons systems, nuclear installations, life-support devices or systems, other medical devices or systems (including resuscitation equipment and surgical implants), pollution control or hazardous substances management, or other uses where the failure of the device or system could cause personal injury, death, or property damage ("Unintended Uses"). A critical component is any component of a device or system whose failure to perform can be reasonably expected to cause the failure of the device or system, or to affect its safety or effectiveness. Cypress is not liable, in whole or in part, and you shall and hereby do release Cypress from any claim, damage, or other liability arising from or related to all Unintended Uses of Cypress products. You shall indemnify and hold Cypress harmless from and against all claims, costs, damages, and other liabilities, including claims for personal injury or death, arising from or related to any Unintended Uses of Cypress products.

Cypress, the Cypress logo, Spansion, the Spansion logo, and combinations thereof, WICED, PSoC, CapSense, EZ-USB, F-RAM, and Traveo are trademarks or registered trademarks of Cypress in the United States and other countries. For a more complete list of Cypress trademarks, visit [cypress.com](http://cypress.com). Other names and brands may be claimed as property of their respective owners.





## Looking for pricing, stock, or lifecycle information?

Click below to explore more details on WIN SOURCE:

 [View CY7C1383D-133AXC on WIN SOURCE](#)

 [Infineon Technologies](#) Information

## Optimize Your Supply Chain with WIN SOURCE Solutions

-  Global Sourcing Solution
-  Obsolete Management
-  Cost Control Management
-  Shortage Management
-  Alternative Solution
-  Excess Inventory Management