



**THE DATASHEET OF
NTSB30100CT-1G**



NTST30100CTG, NTSB30100CT-1G, NTSJ30100CTG, NTSB30100CTG

Very Low Forward Voltage Trench-based Schottky Rectifier

Exceptionally Low $V_F = 0.455\text{ V}$ at $I_F = 5\text{ A}$

Features

- Fine Lithography Trench-based Schottky Technology for Very Low Forward Voltage and Low Leakage
- Fast Switching with Exceptional Temperature Stability
- Low Power Loss and Lower Operating Temperature
- Higher Efficiency for Achieving Regulatory Compliance
- Low Thermal Resistance
- High Surge Capability
- These are Pb-Free Devices

Typical Applications

- Switching Power Supplies including Notebook / Netbook Adapters, ATX and Flat Panel Display
- High Frequency and DC-DC Converters
- Freewheeling and OR-ing diodes
- Reverse Battery Protection
- Instrumentation

Mechanical Characteristics

- Case: Epoxy, Molded
- Epoxy Meets Flammability Rating UL 94-0 @ 0.125 in
- Finish: All External Surfaces Corrosion Resistant and Terminal Leads are Readily Solderable
- Lead Temperature for Soldering Purposes: 260°C Maximum for 10 sec



ON Semiconductor®

www.onsemi.com

PIN CONNECTIONS

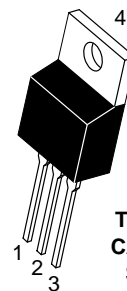
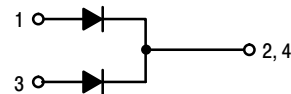

TO-220AB
CASE 221A
STYLE 6

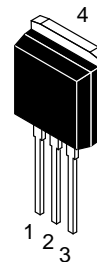

I2PAK
CASE 418D
STYLE 3

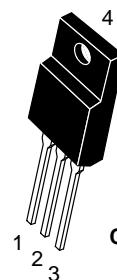

TO-220FP
CASE 221AH

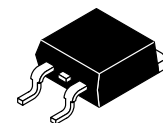

D2PAK
CASE 418B

ORDERING INFORMATION

See detailed ordering and shipping information in the package dimensions section on page 5 of this data sheet.

NTST30100CTG, NTSB30100CT-1G, NTSJ30100CTG, NTSB30100CTG

MAXIMUM RATINGS

Rating	Symbol	Value	Unit
Peak Repetitive Reverse Voltage Working Peak Reverse Voltage DC Blocking Voltage	V_{RRM} V_{RWM} V_R	100	V
Average Rectified Forward Current (Rated V_R , $T_C = 115^\circ\text{C}$)	$I_{F(AV)}$ Per device Per diode	30 15	A
Peak Repetitive Forward Current (Rated V_R , Square Wave, 20 kHz, $T_C = 110^\circ\text{C}$)	I_{FRM} Per device Per diode	60 30	A
Nonrepetitive Peak Surge Current (Surge applied at rated load conditions halfwave, single phase, 60 Hz)	I_{FSM}	160	A
Operating Junction Temperature	T_J	-40 to +150	$^\circ\text{C}$
Storage Temperature	T_{stg}	-40 to +150	$^\circ\text{C}$
Voltage Rate of Change (Rated V_R)	dv/dt	10,000	V/ μs

Stresses exceeding those listed in the Maximum Ratings table may damage the device. If any of these limits are exceeded, device functionality should not be assumed, damage may occur and reliability may be affected.

THERMAL CHARACTERISTICS

Rating	Symbol	NTST30100CTG, NTSB30100CT-1G	NTSB30100CTG	NTSJ30100CTG	Unit
Maximum Thermal Resistance per Diode Junction-to-Case Junction-to-Ambient	$R_{\theta JC}$ $R_{\theta JA}$	2.5 70	1.14 46.6	4.09 105	$^\circ\text{C/W}$ $^\circ\text{C/W}$

ELECTRICAL CHARACTERISTICS (Per Leg unless otherwise noted)

Rating	Symbol	Typ	Max	Unit
Maximum Instantaneous Forward Voltage (Note 1) ($I_F = 5\text{ A}$, $T_J = 25^\circ\text{C}$) ($I_F = 7.5\text{ A}$, $T_J = 25^\circ\text{C}$) ($I_F = 15\text{ A}$, $T_J = 25^\circ\text{C}$) ($I_F = 5\text{ A}$, $T_J = 125^\circ\text{C}$) ($I_F = 7.5\text{ A}$, $T_J = 125^\circ\text{C}$) ($I_F = 15\text{ A}$, $T_J = 125^\circ\text{C}$)	V_F	0.516 0.576 0.734 0.455 0.522 0.627	- - 0.85 - - 0.68	V
Maximum Instantaneous Reverse Current (Note 1) ($V_R = 70\text{ V}$, $T_J = 25^\circ\text{C}$) ($V_R = 70\text{ V}$, $T_J = 125^\circ\text{C}$) (Rated dc Voltage, $T_J = 25^\circ\text{C}$) (Rated dc Voltage, $T_J = 125^\circ\text{C}$)	I_R	7.2 8.0 65 20	 500 35	μA mA μA mA

Product parametric performance is indicated in the Electrical Characteristics for the listed test conditions, unless otherwise noted. Product performance may not be indicated by the Electrical Characteristics if operated under different conditions.

1. Pulse Test: Pulse Width = 300 μs , Duty Cycle $\leq 2.0\%$

TYPICAL CHARACTERISTICS

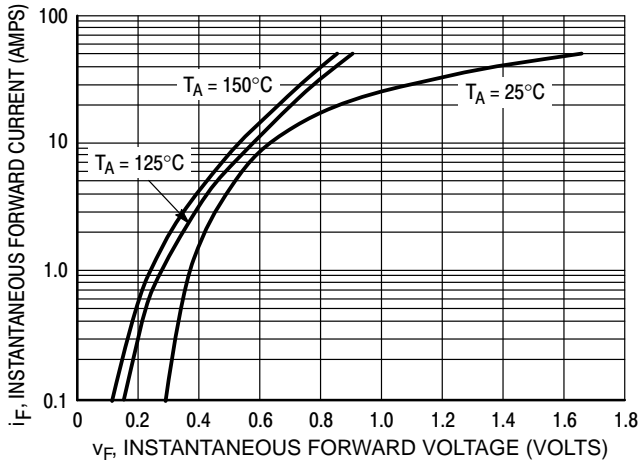

Figure 1. Typical Forward Voltage

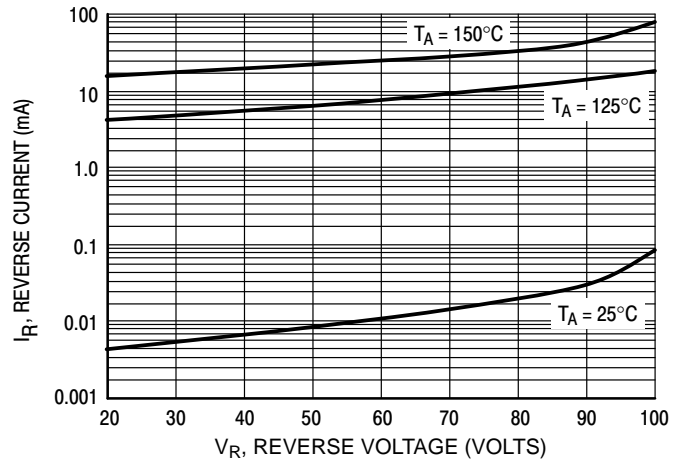

Figure 2. Typical Reverse Current

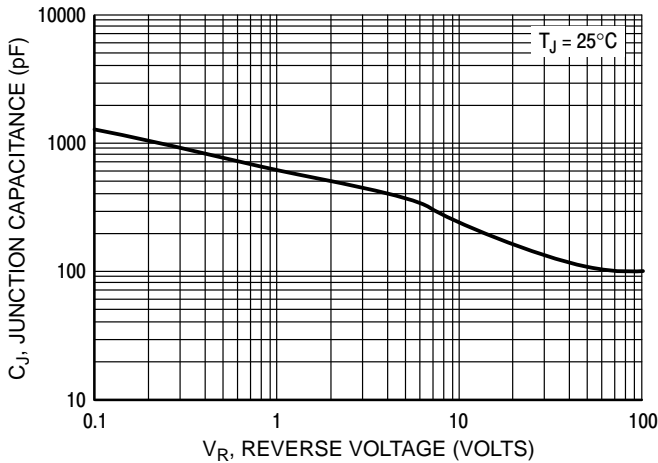

Figure 3. Typical Junction Capacitance

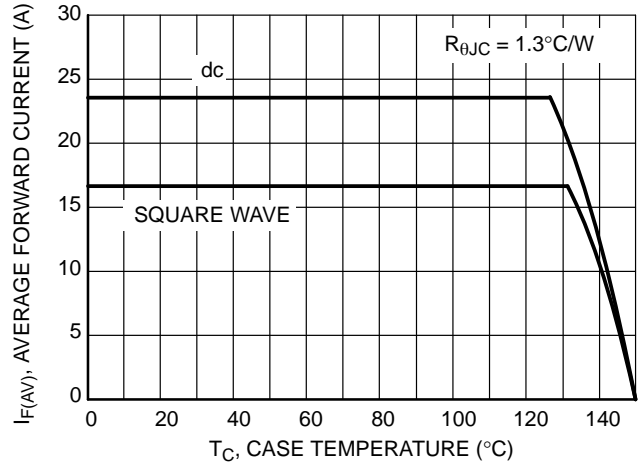

Figure 4. Current Derating per Leg

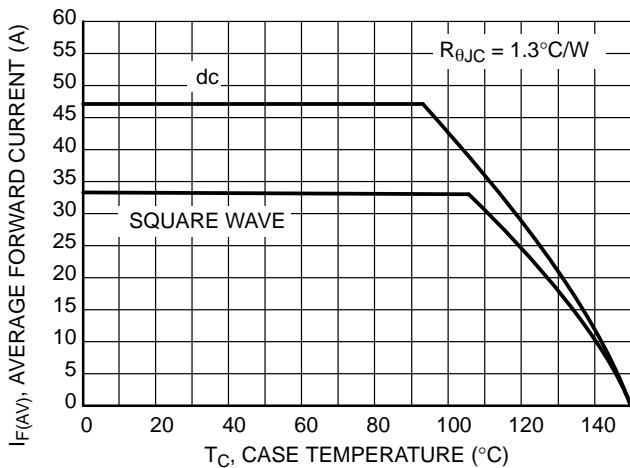

Figure 5. Current Derating

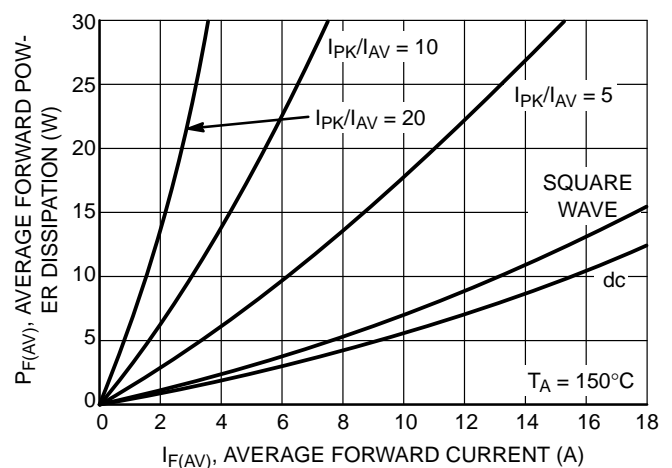

Figure 6. Forward Power Dissipation

TYPICAL CHARACTERISTICS

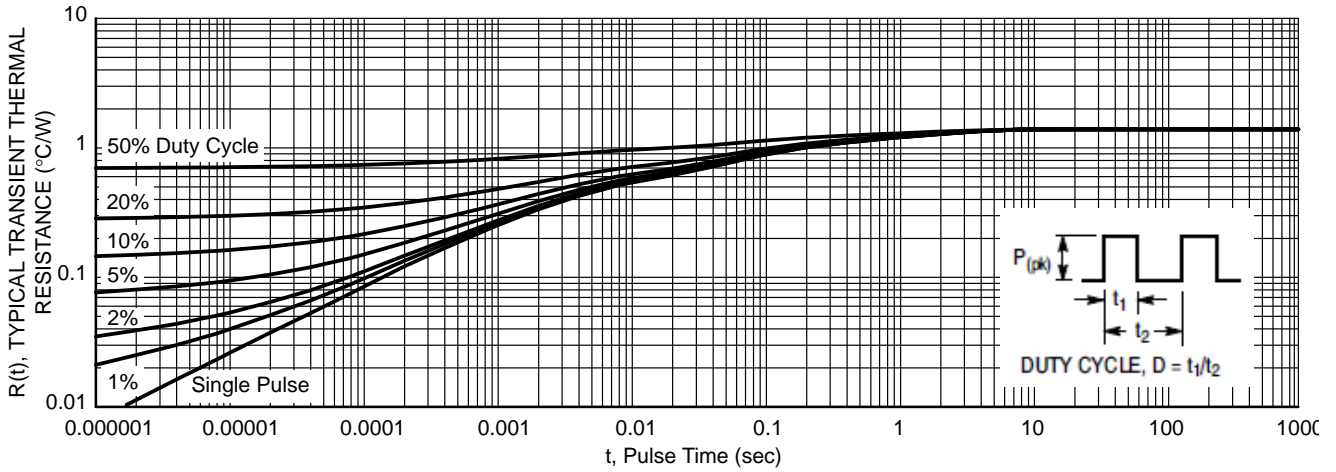

Figure 7. Typical Transient Thermal Response, Junction-to-Case for NTST30100CT and NTSB30100CT-1G

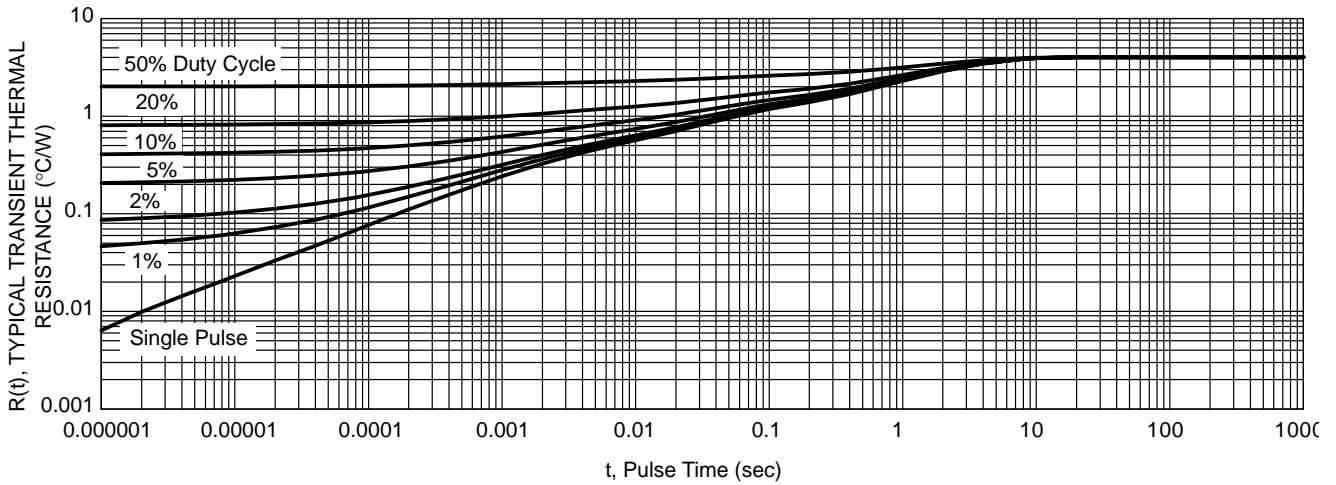

Figure 8. Typical Transient Thermal Response, Junction-to-Case for NTSJ30100CTG

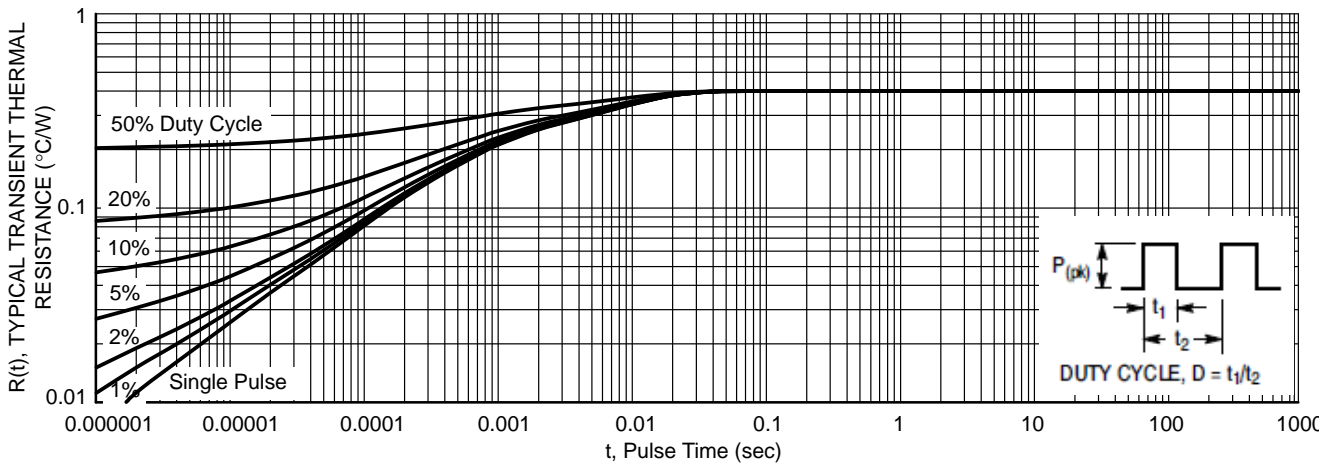

Figure 9. Typical Transient Thermal Response, Junction-to-Case for NTSB30100CTG

NTST30100CTG, NTSB30100CT-1G, NTSJ30100CTG, NTSB30100CTG

ORDERING INFORMATION

Device	Package	Shipping
NTST30100CTG	TO-220AB (Pb-Free)	50 Units / Rail
NTSB30100CT-1G	I ² PAK (Pb-Free)	50 Units / Rail
NTSJ30100CTG	TO-220FP (Halide-Free)	50 Units / Rail
NTSB30100CTG	D ² PAK (Pb-Free)	50 Units / Rail
NTSB30100CTT4G	D ² PAK (Pb-Free)	800 / Tape & Reel

MARKING DIAGRAMS

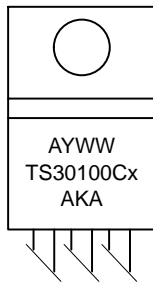

TO-220AB

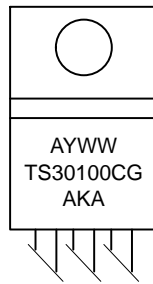

TO-220FP

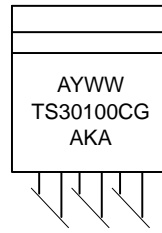

I²PAK

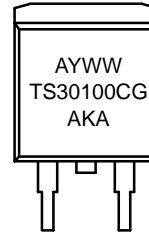

D²PAK

- A = Assembly Location
- Y = Year
- WW = Work Week
- AKA = Polarity Designator
- x = G or H
- G = Pb-Free Package
- H = Halide-Free Package

PACKAGE DIMENSIONS

TO-220
CASE 221A-09
ISSUE AH

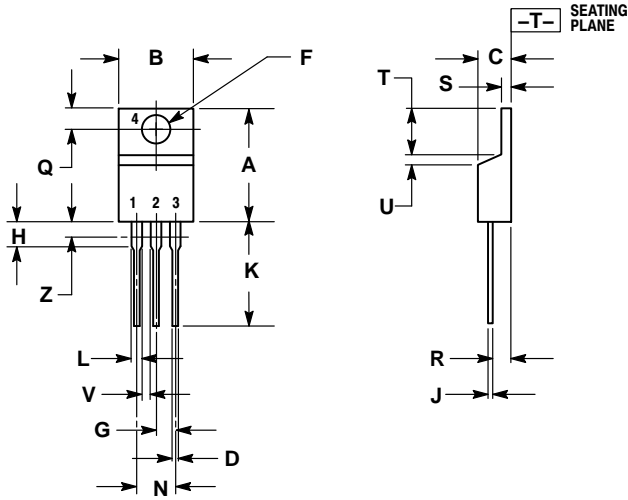

- NOTES:
1. DIMENSIONING AND TOLERANCING PER ANSI Y14.5M, 1982.
 2. CONTROLLING DIMENSION: INCH.
 3. DIMENSION Z DEFINES A ZONE WHERE ALL BODY AND LEAD IRREGULARITIES ARE ALLOWED.

DIM	INCHES		MILLIMETERS	
	MIN	MAX	MIN	MAX
A	0.570	0.620	14.48	15.75
B	0.380	0.415	9.66	10.53
C	0.160	0.190	4.07	4.83
D	0.025	0.038	0.64	0.96
F	0.142	0.161	3.61	4.09
G	0.095	0.105	2.42	2.66
H	0.110	0.161	2.80	4.10
J	0.014	0.024	0.36	0.61
K	0.500	0.562	12.70	14.27
L	0.045	0.060	1.15	1.52
N	0.190	0.210	4.83	5.33
Q	0.100	0.120	2.54	3.04
R	0.080	0.110	2.04	2.79
S	0.045	0.055	1.15	1.39
T	0.235	0.255	5.97	6.47
U	0.000	0.050	0.00	1.27
V	0.045	---	1.15	---
Z	---	0.080	---	2.04

- STYLE 6:
1. ANODE
 2. CATHODE
 3. ANODE
 4. CATHODE

I²PAK (TO-262)
CASE 418D
ISSUE D

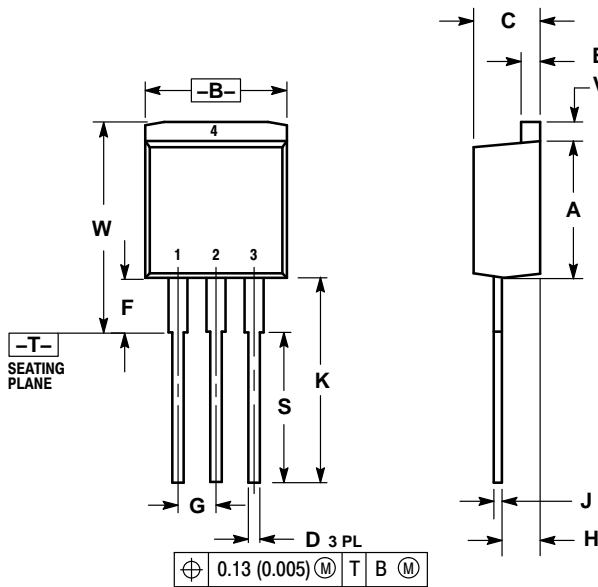

- NOTES:
1. DIMENSIONING AND TOLERANCING PER ANSI Y14.5M, 1982.
 2. CONTROLLING DIMENSION: INCH.

DIM	INCHES		MILLIMETERS	
	MIN	MAX	MIN	MAX
A	0.335	0.380	8.51	9.65
B	0.380	0.406	9.65	10.31
C	0.160	0.185	4.06	4.70
D	0.026	0.035	0.66	0.89
E	0.045	0.055	1.14	1.40
F	0.122 REF		3.10 REF	
G	0.100 BSC		2.54 BSC	
H	0.094	0.110	2.39	2.79
J	0.013	0.025	0.33	0.64
K	0.500	0.562	12.70	14.27
S	0.390 REF		9.90 REF	
V	0.045	0.070	1.14	1.78
W	0.522	0.551	13.25	14.00

PACKAGE DIMENSIONS

TO-220 FULLPACK, 3-LEAD
CASE 221AH
ISSUE F

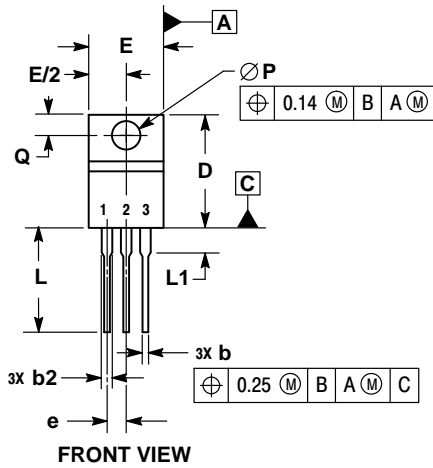

FRONT VIEW

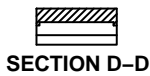

SECTION D-D

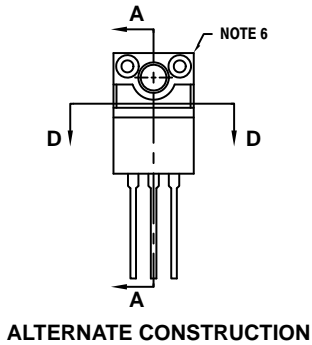

ALTERNATE CONSTRUCTION

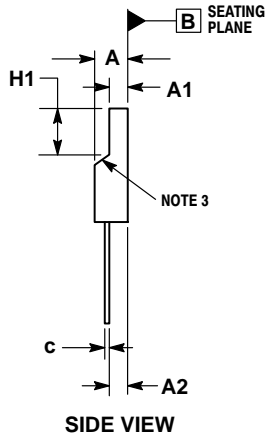

SIDE VIEW

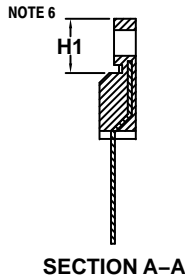

SECTION A-A

NOTES:

1. DIMENSIONING AND TOLERANCING PER ASME Y14.5M, 1994.
2. CONTROLLING DIMENSION: MILLIMETERS.
3. CONTOUR UNCONTROLLED IN THIS AREA.
4. DIMENSIONS D AND E DO NOT INCLUDE MOLD FLASH AND GATE PROTRUSIONS. MOLD FLASH AND GATE PROTRUSIONS NOT TO EXCEED 0.13 PER SIDE. THESE DIMENSIONS ARE TO BE MEASURED AT OUTERMOST EXTREME OF THE PLASTIC BODY.
5. DIMENSION b2 DOES NOT INCLUDE DAMBAR PROTRUSION. LEAD WIDTH INCLUDING PROTRUSION SHALL NOT EXCEED 2.00.
6. CONTOURS AND FEATURES OF THE MOLDED PACKAGE BODY MAY VARY WITHIN THE ENVELOPE DEFINED BY DIMENSIONS A1 AND H1 FOR MANUFACTURING PURPOSES.

MILLIMETERS		
DIM	MIN	MAX
A	4.30	4.70
A1	2.50	2.90
A2	2.50	2.90
b	0.54	0.84
b2	1.10	1.40
c	0.49	0.79
D	14.70	15.30
E	9.70	10.30
e	2.54 BSC	
H1	6.60	7.10
L	12.50	14.73
L1	---	2.80
P	3.00	3.40
Q	2.80	3.20

PACKAGE DIMENSIONS

D²PAK 3
CASE 418B-04
ISSUE K

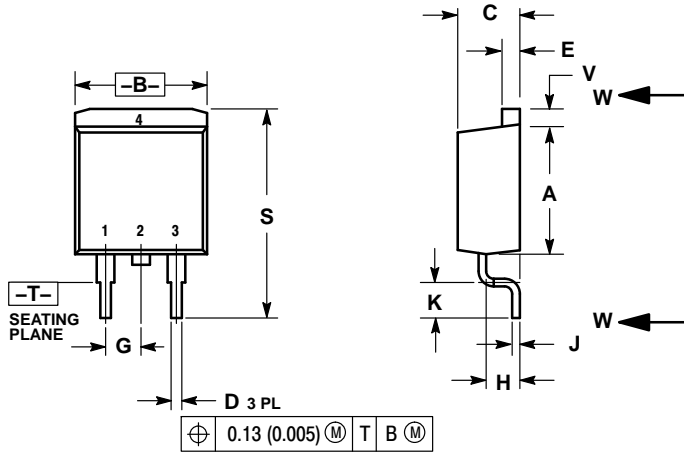

- NOTES:
1. DIMENSIONING AND TOLERANCING PER ANSI Y14.5M, 1982.
2. CONTROLLING DIMENSION: INCH.
3. 418B-01 THRU 418B-03 OBSOLETE, NEW STANDARD 418B-04.

DIM	INCHES		MILLIMETERS	
	MIN	MAX	MIN	MAX
A	0.340	0.380	8.64	9.65
B	0.380	0.405	9.65	10.29
C	0.160	0.190	4.06	4.83
D	0.020	0.035	0.51	0.89
E	0.045	0.055	1.14	1.40
F	0.310	0.350	7.87	8.89
G	0.100 BSC		2.54 BSC	
H	0.080	0.110	2.03	2.79
J	0.018	0.025	0.46	0.64
K	0.090	0.110	2.29	2.79
L	0.052	0.072	1.32	1.83
M	0.280	0.320	7.11	8.13
N	0.197 REF		5.00 REF	
P	0.079 REF		2.00 REF	
R	0.039 REF		0.99 REF	
S	0.575	0.625	14.60	15.88
V	0.045	0.055	1.14	1.40

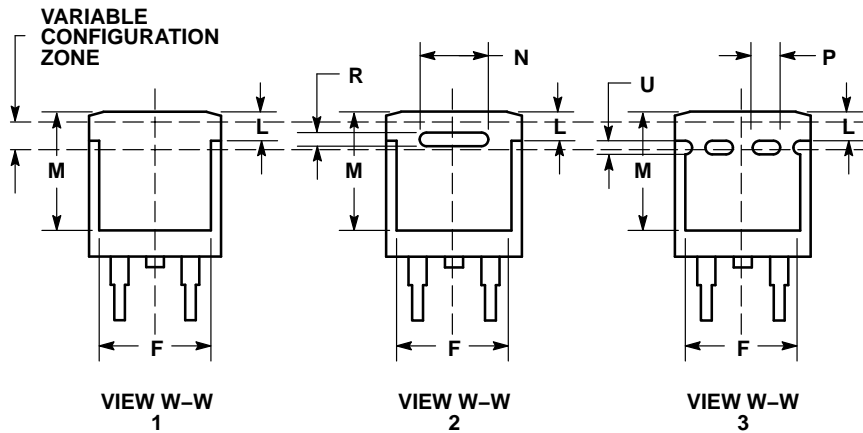

ON Semiconductor and are trademarks of Semiconductor Components Industries, LLC dba ON Semiconductor or its subsidiaries in the United States and/or other countries. ON Semiconductor owns the rights to a number of patents, trademarks, copyrights, trade secrets, and other intellectual property. A listing of ON Semiconductor's product/patent coverage may be accessed at www.onsemi.com/site/pdf/Patent-Marking.pdf. ON Semiconductor reserves the right to make changes without further notice to any products herein. ON Semiconductor makes no warranty, representation or guarantee regarding the suitability of its products for any particular purpose, nor does ON Semiconductor assume any liability arising out of the application or use of any product or circuit, and specifically disclaims any and all liability, including without limitation special, consequential or incidental damages. Buyer is responsible for its products and applications using ON Semiconductor products, including compliance with all laws, regulations and safety requirements or standards, regardless of any support or applications information provided by ON Semiconductor. "Typical" parameters which may be provided in ON Semiconductor data sheets and/or specifications can and do vary in different applications and actual performance may vary over time. All operating parameters, including "Typicals" must be validated for each customer application by customer's technical experts. ON Semiconductor does not convey any license under its patent rights nor the rights of others. ON Semiconductor products are not designed, intended, or authorized for use as a critical component in life support systems or any FDA Class 3 medical devices or medical devices with a same or similar classification in a foreign jurisdiction or any devices intended for implantation in the human body. Should Buyer purchase or use ON Semiconductor products for any such unintended or unauthorized application, Buyer shall indemnify and hold ON Semiconductor and its officers, employees, subsidiaries, affiliates, and distributors harmless against all claims, costs, damages, and expenses, and reasonable attorney fees arising out of, directly or indirectly, any claim of personal injury or death associated with such unintended or unauthorized use, even if such claim alleges that ON Semiconductor was negligent regarding the design or manufacture of the part. ON Semiconductor is an Equal Opportunity/Affirmative Action Employer. This literature is subject to all applicable copyright laws and is not for resale in any manner.

PUBLICATION ORDERING INFORMATION

LITERATURE FULFILLMENT:
Literature Distribution Center for ON Semiconductor
19521 E. 32nd Pkwy, Aurora, Colorado 80011 USA
Phone: 303-675-2175 or 800-344-3860 Toll Free USA/Canada
Fax: 303-675-2176 or 800-344-3867 Toll Free USA/Canada
Email: orderlit@onsemi.com

N. American Technical Support: 800-282-9855 Toll Free
USA/Canada
Europe, Middle East and Africa Technical Support:
Phone: 421 33 790 2910
Japan Customer Focus Center
Phone: 81-3-5817-1050

ON Semiconductor Website: www.onsemi.com
Order Literature: <http://www.onsemi.com/orderlit>
For additional information, please contact your local Sales Representative

Looking for pricing, stock, or lifecycle information?

Click below to explore more details on WIN SOURCE:

 [View NTSB30100CT-1G on WIN SOURCE](#)

 [ON Semiconductor](#) Information

Optimize Your Supply Chain with WIN SOURCE Solutions

-  Global Sourcing Solution
-  Obsolete Management
-  Cost Control Management
-  Shortage Management
-  Alternative Solution
-  Excess Inventory Management