



**THE DATASHEET OF
DS90C031WGRQMLV**



DS90C031QML LVDS Quad CMOS Differential Line Driver

 Check for Samples: [DS90C031QML](#)

FEATURES

- Radiation guaranteed 100 krad(Si)
- High impedance LVDS outputs with power-off
- ± 350 mV differential signaling
- Low power dissipation
- Low differential skew
- Low propagation delay
- Pin compatible with DS26C31
- Compatible with IEEE 1596.3 SCI LVDS standard
- Compatible with proposed TIA LVDS standard
- Fail safe logic for floating inputs

DESCRIPTION

The DS90C031 is a quad CMOS differential line driver designed for applications requiring ultra low power dissipation and high data rates.

The DS90C031 accepts TTL/CMOS input levels and translates them to low voltage (350 mV) differential output signals. In addition the driver supports a TRI-STATE function that may be used to disable the output stage, thus dropping the device to a low idle power state of 11 mW typical.

In addition, the DS90C031 provides power-off high impedance LVDS outputs. This feature assures minimal loading effect on the LVDS bus lines when V_{CC} is not present. The DS90C031 and companion line receiver (DS90C032) provide a new alternative to high power psuedo-ECL devices for high speed point-to-point interface applications.

Connection Diagram

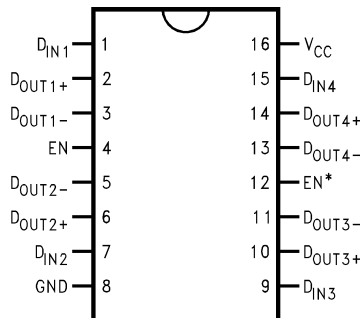

Figure 1. Dual-In-Line
See Package Number NAD0016A & NAC0016A

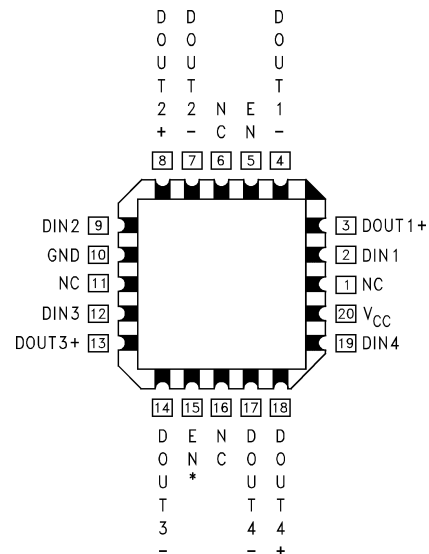

Figure 2. LCCC Package
See Package Number NAJ0020A



Please be aware that an important notice concerning availability, standard warranty, and use in critical applications of Texas Instruments semiconductor products and disclaimers thereto appears at the end of this data sheet.

All trademarks are the property of their respective owners.

Functional Block Diagram

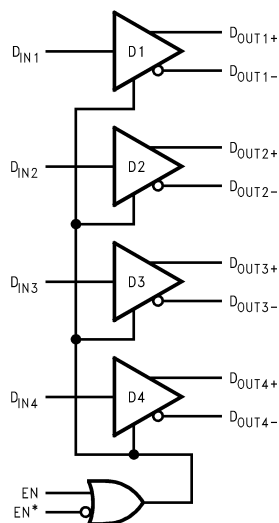

Truth Table

Enables		Input	Outputs	
EN	EN*	D _I	D _{O+}	D _{O-}
L	H	X	Z	Z
All other combinations of ENABLE inputs		L	L	H
		H	H	L



These devices have limited built-in ESD protection. The leads should be shorted together or the device placed in conductive foam during storage or handling to prevent electrostatic damage to the MOS gates.

Absolute Maximum Ratings⁽¹⁾

Supply Voltage (V_{CC})	-0.3V to +6V
Input Voltage (D_i)	-0.3V to ($V_{CC} + 0.3V$)
Enable Input Voltage (EN, EN*)	-0.3V to ($V_{CC} + 0.3V$)
Output Voltage (D_{O+} , D_{O-})	-0.3V to + 5.8V
Storage Temperature Range	$-65^{\circ}\text{C} \leq T_A \leq +150^{\circ}\text{C}$
Lead Temperature Range, Soldering (4 seconds)	+260°C
Maximum Package Power Dissipation at +25°C ⁽²⁾	
20 Pin LCCC Package	1900 mW
16 Pin CLGA (NAD)	1450 mW
16 Pin CLGA (NAC)	1450 mW
Thermal Resistance	
θ_{JA}	
20 Pin LCCC Package	78°C/W
16 Pin CLGA (NAD)	145°C/W
16 Pin CLGA (NAC)	145°C/W
θ_{JC}	
20 Pin LCCC Package	18°C/W
16 Pin CLGA (NAD)	14°C/W
16 Pin CLGA (NAC)	14°C/W
ESD Rating ⁽³⁾	3.5KV

(1) Absolute Maximum Ratings indicate limits beyond which damage to the device may occur. Operating Ratings indicate conditions for which the device is functional, but do not guarantee specific performance limits. For guaranteed specifications and test conditions, see the Electrical Characteristics. The guaranteed specifications apply only for the test conditions listed. Some performance characteristics may degrade when the device is not operated under the listed test conditions.

(2) Derate LCCC at 12.8mW/°C above +25°C. Derate CLGA at 6.9mW/°C above +25°C.

(3) Human body model, 1.5 k Ω in series with 100 pF.

Recommended Operating Conditions

	Min	Typ	Max	Unit
Supply Voltage (V_{CC})	+4.5	+5.0	+5.5	V
Operating Free Air Temperature (T_A)	-55	+25	+125	°C

Quality Conformance Inspection

Table 1. Mil-Std-883, Method 5005 - Group A

Subgroup	Description	Temp (°C)
1	Static tests at	+25
2	Static tests at	+125
3	Static tests at	-55
4	Dynamic tests at	+25
5	Dynamic tests at	+125
6	Dynamic tests at	-55
7	Functional tests at	+25
8A	Functional tests at	+125
8B	Functional tests at	-55
9	Switching tests at	+25
10	Switching tests at	+125
11	Switching tests at	-55
12	Settling time at	+25
13	Settling time at	+125
14	Settling time at	-55

DC Parameters ⁽¹⁾

Symbol	Parameter	Conditions	Notes	Min	Max	Units	Sub-groups
V _{OD1}	Differential Output Voltage	R _L = 100Ω		250	450	mV	1, 2, 3
DV _{OD1}	Change in Magnitude of Vod1 for complementary output States	R _L = 100Ω			35	mV	1, 2, 3
V _{OS}	Offset Voltage	R _L = 100Ω		1.12 5	1.37 5	V	1, 2, 3
DV _{OS}	Change in Magnitude of Vos for Complementary Output States	R _L = 100Ω			25	mV	1, 2, 3
V _{OH}	Output Voltage High	R _L = 100Ω			1.6	V	1, 2, 3
V _{OL}	Output Voltage Low	R _L = 100Ω		0.9		V	1, 2, 3
V _{IH}	Input Voltage High		(2)	2.0	V _{CC}	V	1, 2, 3
V _{IL}	Input Voltage Low		(2)	Gnd	0.8	V	1, 2, 3
I _I	Input Current	V _I = V _{CC} , Gnd, 2.5, or 0.4V			±10	μA	1, 2, 3
V _{CI}	Input Clamp Voltage	I _{CI} = -18mA			-1.5	V	1, 2, 3
I _{OS}	Output Short Circuit Current	V _O = 0V			-5.0	mA	1, 2, 3
I _{Off}	Power-off Leakage	V _O = 0V or 2.4V, V _{CC} = 0V or Open			±10	μA	1, 2, 3
I _{OZ}	Output TRI-STATE Current	EN = 0.8V and EN* = 2.0V V _O = 0V or V _{CC}			±10	μA	1, 2, 3
I _{CC}	Drivers Enabled Supply Current	D _I = Hi or Low			25	mA	1, 2, 3
I _{CCZ}	Drivers Disabled Supply Current	D _I = Hi or Low, En = Gnd, En* = V _{CC}			10	mA	1, 2, 3

(1) Pre and Post irradiation limits are identical to those listed under AC and DC electrical characteristics except as listed in the "Post Radiation Limits" table. Radiation end point limits for the noted parameters are guaranteed only for the conditions, as specified.

(2) Tested during V_{OH} / V_{OL} tests.

AC Parameters

The following conditions apply, unless otherwise specified.

AC: $V_{CC} = 4.5V / 5.0V / 5.5V$, $R_L = 100\Omega$ (between outputs), $C_L = 20pF$ (each output to Gnd)

Symbol	Parameter	Conditions	Notes	Min	Max	Units	Sub-groups
t_{PHLD}	Differential Propagation Delay High to Low			0.5	5.0	ns	9, 10, 11
t_{PLHD}	Differential Propagation Delay Low to High			0.5	5.0	ns	9, 10, 11
t_{SKD}	Differential Skew $ t_{PHLD} - t_{PLHD} $				3.0	ns	9, 10, 11
t_{SK1}	Channel to Channel Skew		(1)		3.0	ns	9, 10, 11
t_{SK2}	Chip to Chip Skew		(2)		4.5	ns	9, 10, 11
t_{PHZ}	Disable Time High to Z		(3)		20	ns	9, 10, 11
t_{PLZ}	Disable Time Low To Z		(3)		20	ns	9, 10, 11
t_{PZH}	Enable Time Z to High		(3)		20	ns	9, 10, 11
t_{PZL}	Enable Time Z to Low		(3)		20	ns	9, 10, 11

- (1) Channel-to-Channel Skew is defined as the difference between the propagation delay of the channel and the other channels in the same chip with an event on the inputs.
 (2) Chip to Chip Skew is defined as the difference between the minimum and maximum specified differential propagation delays.
 (3) Parameter guaranteed, not tested 100%

AC/DC Parameters - Post Radiation Limits ⁽¹⁾

Symbol	Parameter	Conditions	Notes	Min	Max	Units	Sub-groups
I_{CC}	Drivers Enabled Supply Current	$D_I - Hi$ or Low, $E_n = Gnd$, $E_n^* = V_{CC}$			30	mA	1
I_{CCZ}	Drivers Disabled Supply Current	$D_I - Hi$ or Low, $E_n = Gnd$, $E_n^* = V_{CC}$			30	mA	1

- (1) Pre and Post irradiation limits are identical to those listed under AC and DC electrical characteristics except as listed in the "Post Radiation Limits" table. Radiation end point limits for the noted parameters are guaranteed only for the conditions, as specified.

Parameter Measurement Information

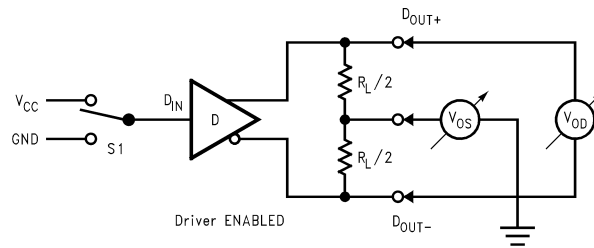

Figure 3. Driver V_{OD} and V_{OS} Test Circuit

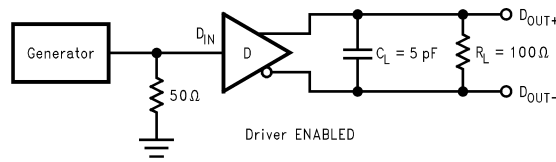

Figure 4. Driver Propagation Delay and Transition Time Test Circuit

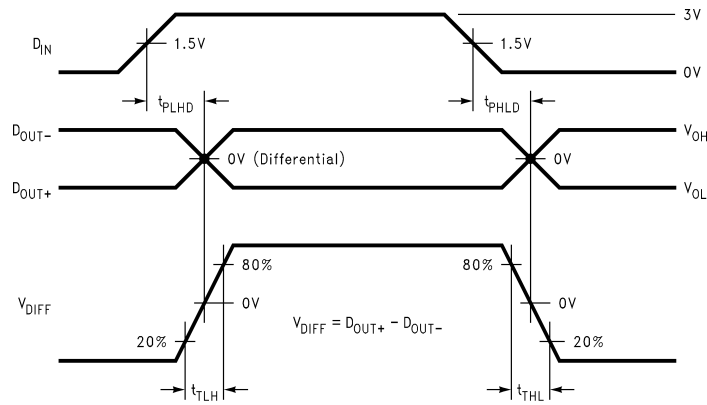

Figure 5. Driver Propagation Delay and Transition Time Waveforms

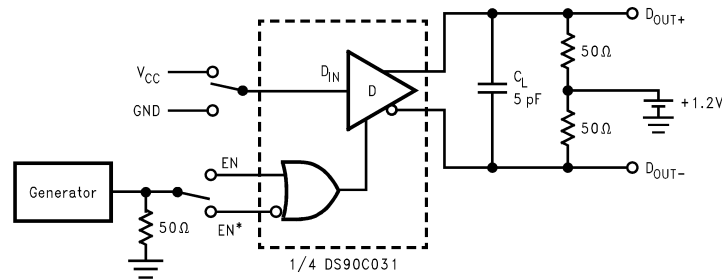

Figure 6. Driver TRI-STATE Delay Test Circuit

Parameter Measurement Information (continued)

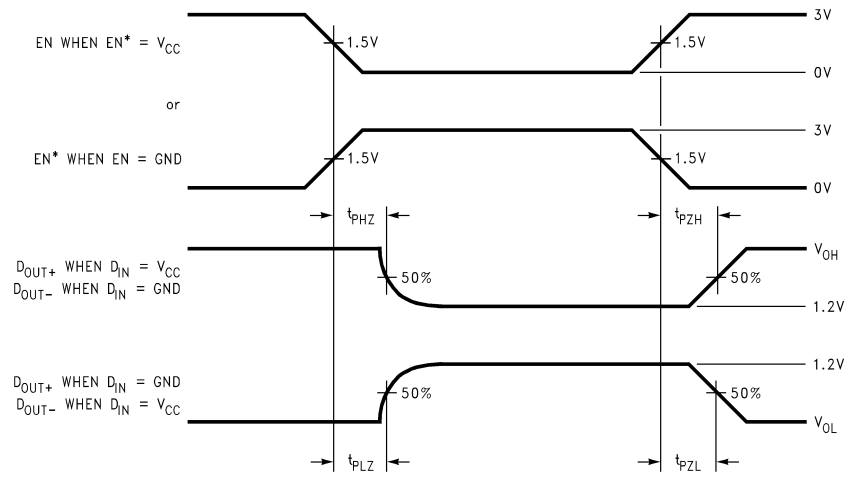

Figure 7. Driver TRI-STATE Delay Waveform

Typical Performance Characteristics

Power Supply Current vs Power Supply Voltage

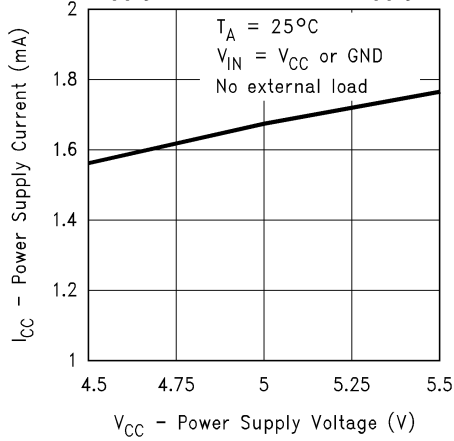

Figure 8.

Power Supply Current vs Temperature

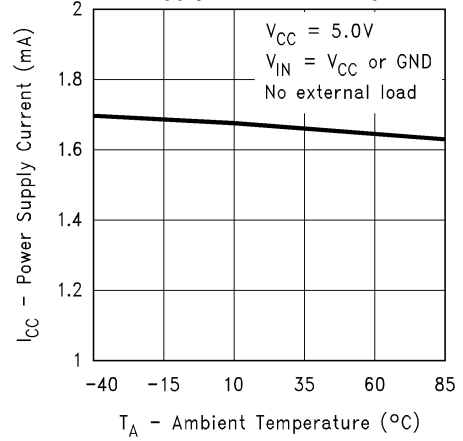

Figure 9.

Power Supply Current vs Power Supply Voltage

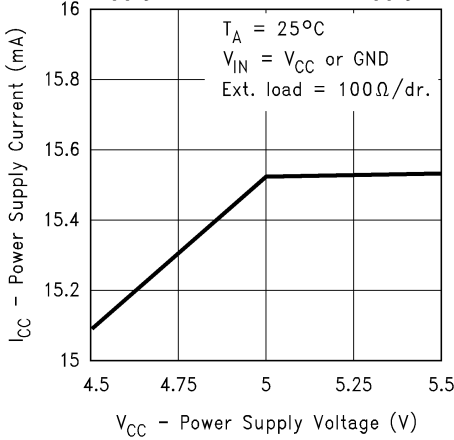

Figure 10.

Power Supply Current vs Temperature

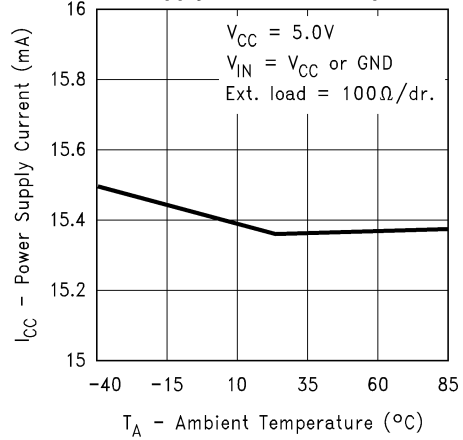

Figure 11.

Output TRI-STATE Current vs Power Supply Voltage

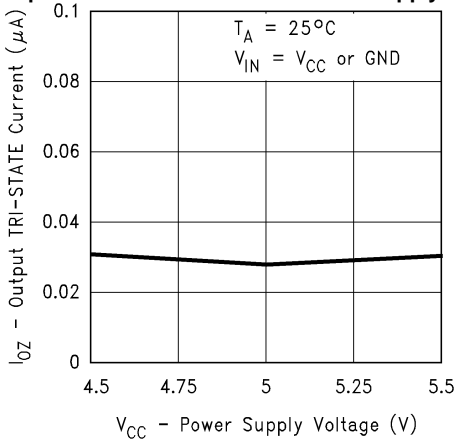

Figure 12.

Output Short Circuit Current vs Power Supply Voltage

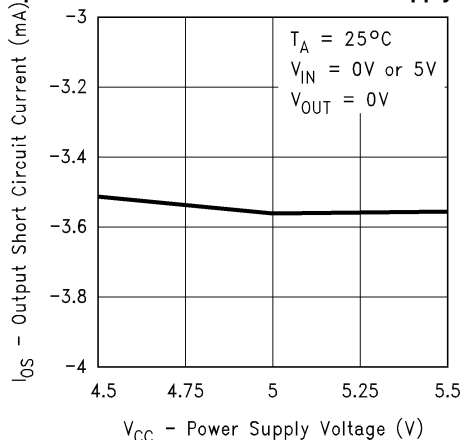

Figure 13.

Typical Performance Characteristics (continued)

Differential Output Voltage vs Power Supply Voltage

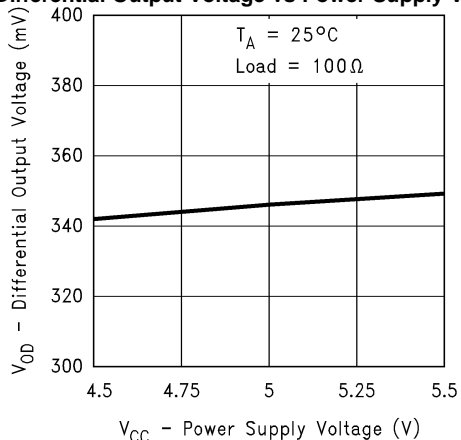

Figure 14.

Differential Output Voltage vs Ambient Temperature

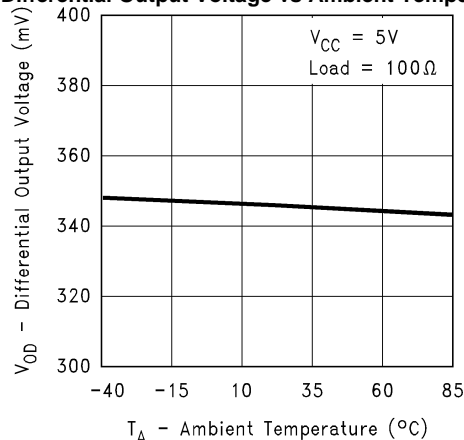

Figure 15.

Output Voltage High vs Power Supply Voltage

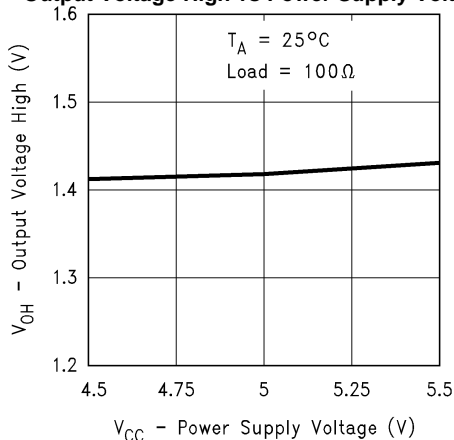

Figure 16.

Output Voltage High vs Ambient Temperature

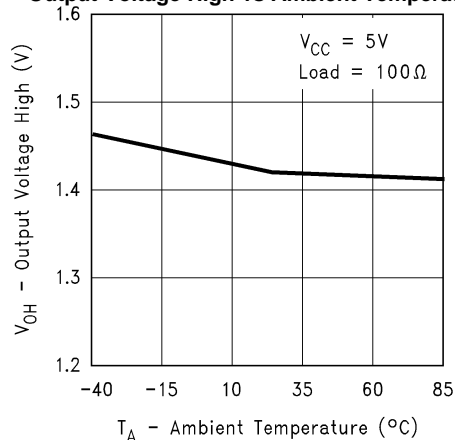

Figure 17.

Output Voltage Low vs Power Supply Voltage

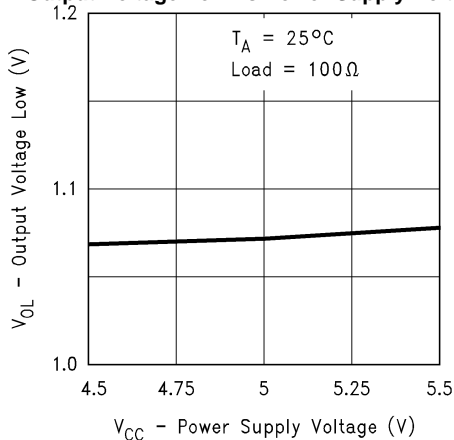

Figure 18.

Output Voltage Low vs Ambient Temperature

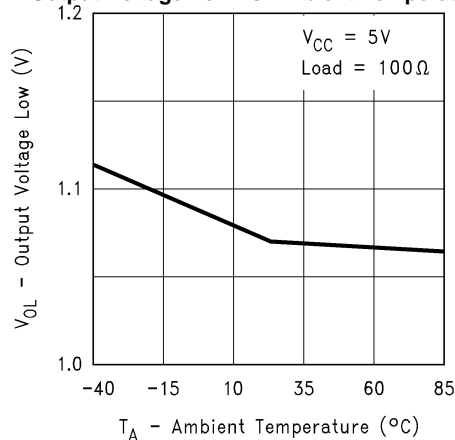

Figure 19.

Typical Performance Characteristics (continued)

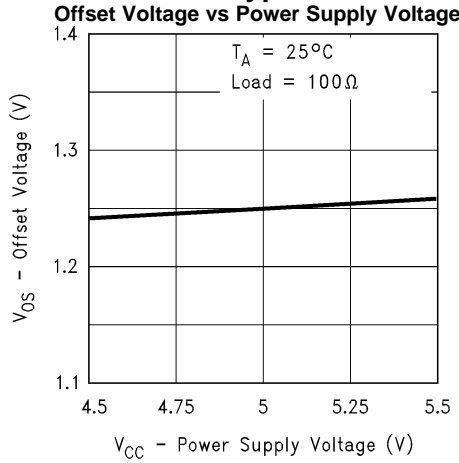

Figure 20.

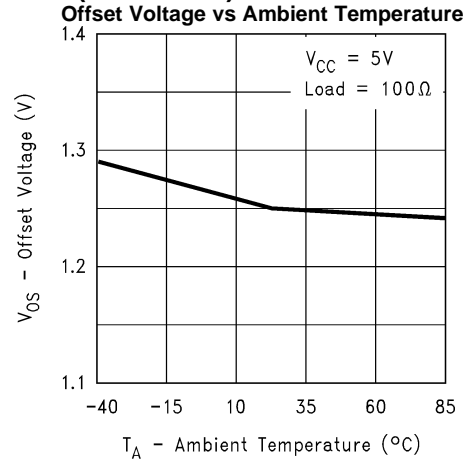

Figure 21.

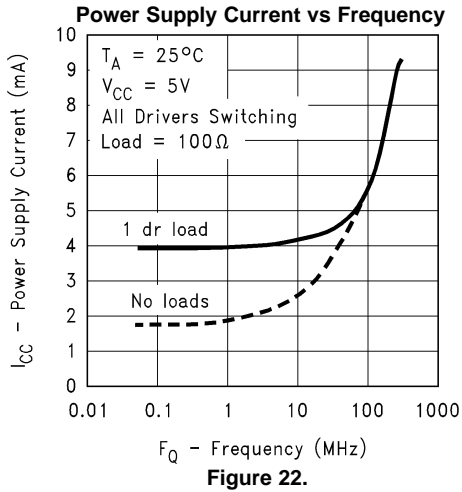

Figure 22.

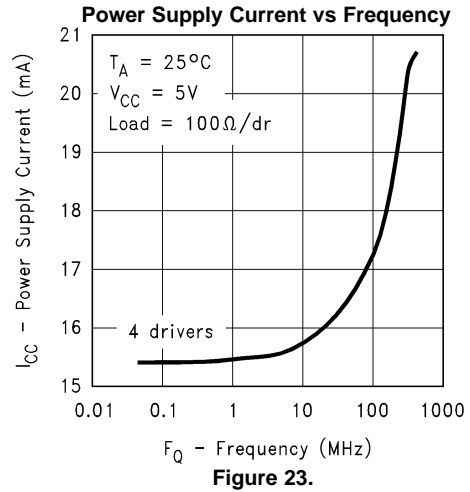

Figure 23.

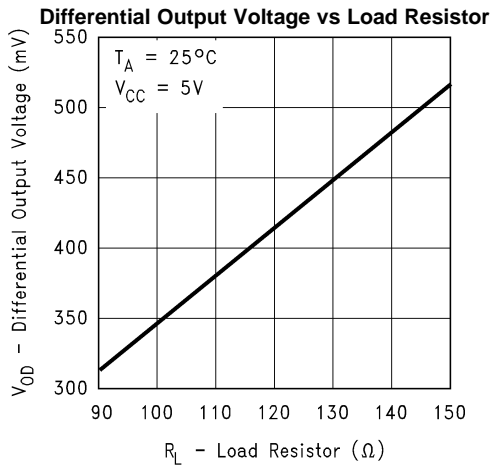

Figure 24.

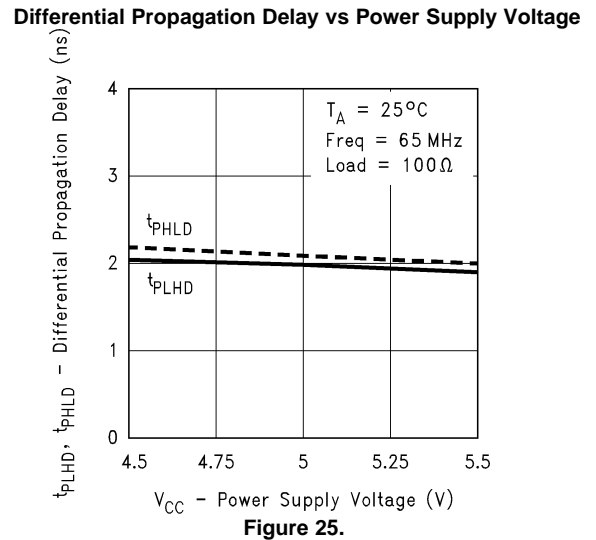

Figure 25.

Typical Performance Characteristics (continued)

Differential Propagation Delay vs Ambient Temperature

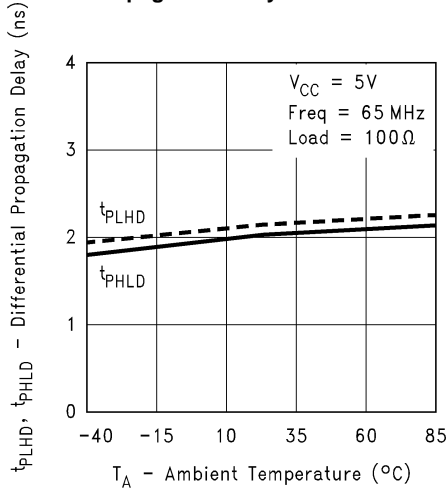

Figure 26.

Differential Skew vs Power Supply Voltage

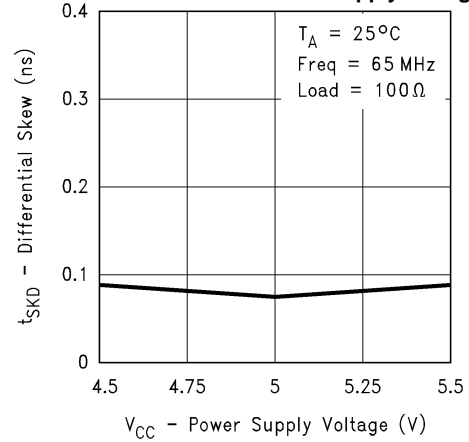

Figure 27.

Differential Skew vs Ambient Temperature

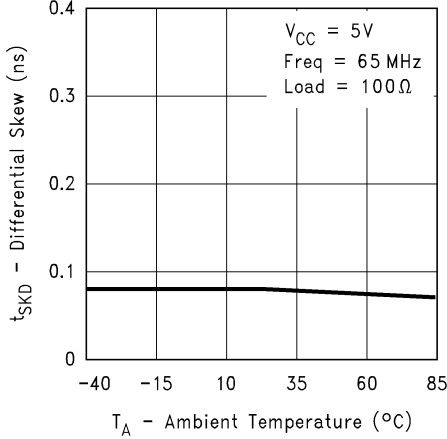

Figure 28.

Differential Transition Time vs Power Supply Voltage

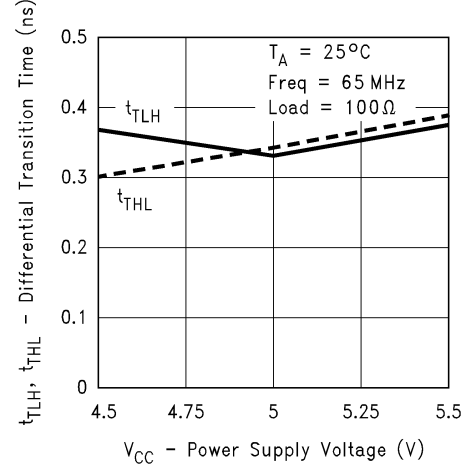

Figure 29.

Differential Transition Time vs Ambient Temperature

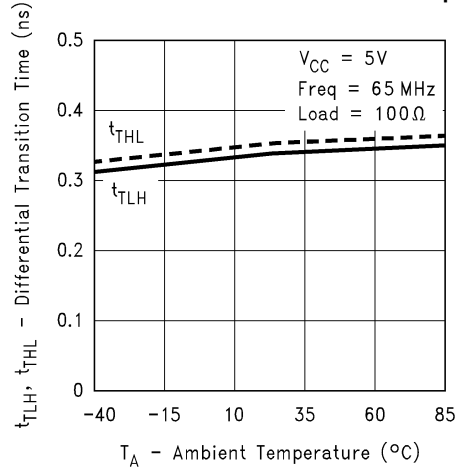

Figure 30.

TYPICAL APPLICATION

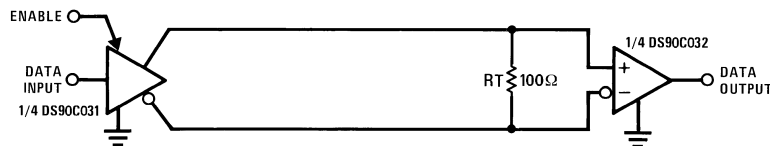

Figure 31. Point-to-Point Application

APPLICATIONS INFORMATION

LVDS drivers and receivers are intended to be primarily used in an uncomplicated point-to-point configuration as is shown in [Figure 31](#). This configuration provides a clean signaling environment for the quick edge rates of the drivers. The receiver is connected to the driver through a balanced media which may be a standard twisted pair cable, a parallel pair cable, or simply PCB traces. Typically, the characteristic impedance of the media is in the range of 100Ω. A termination resistor of 100Ω should be selected to match the media, and is located as close to the receiver input pins as possible. The termination resistor converts the current sourced by the driver into a voltage that is detected by the receiver. Other configurations are possible such as a multi-receiver configuration, but the effects of a mid-stream connector(s), cable stub(s), and other impedance discontinuities as well as ground shifting, noise margin limits, and total termination loading must be taken into account.

The DS90C031 differential line driver is a balanced current source design. A current mode driver, generally speaking has a high output impedance and supplies a constant current for a range of loads (a voltage mode driver on the other hand supplies a constant voltage for a range of loads). Current is switched through the load in one direction to produce a logic state and in the other direction to produce the other logic state. The typical output current is mere 3.4 mA, a minimum of 2.5 mA, and a maximum of 4.5 mA. The current mode **requires** (as discussed above) that a resistive termination be employed to terminate the signal and to complete the loop as shown in [Figure 31](#). AC or unterminated configurations are not allowed. The 3.4 mA loop current will develop a differential voltage of 340 mV across the 100Ω termination resistor which the receiver detects with a 240 mV minimum differential noise margin neglecting resistive line losses (driven signal minus receiver threshold (340 mV – 100 mV = 240 mV)). The signal is centered around +1.2V (Driver Offset, V_{OS}) with respect to ground as shown in [Figure 32](#). Note that the steady-state voltage (V_{SS}) peak-to-peak swing is twice the differential voltage (V_{OD}) and is typically 680 mV.

The current mode driver provides substantial benefits over voltage mode drivers, such as an RS-422 driver. Its quiescent current remains relatively flat versus switching frequency. Whereas the RS-422 voltage mode driver increases exponentially in most case between 20 MHz–50 MHz. This is due to the overlap current that flows between the rails of the device when the internal gates switch. Whereas the current mode driver switches a fixed current between its output without any substantial overlap current. This is similar to some ECL and PECL devices, but without the heavy static I_{CC} requirements of the ECL/PECL designs. LVDS requires > 80% less current than similar PECL devices. AC specifications for the driver are a tenfold improvement over other existing RS-422 drivers.

The TRI-STATE function allows the driver outputs to be disabled, thus obtaining an even lower power state when the transmission of data is not required. The LVDS outputs are high impedance under power-off condition. This allows for multiple or redundant drivers to be used in certain applications.

The footprint of the DS90C031 is the same as the industry standard 26LS31 Quad Differential (RS-422) Driver.

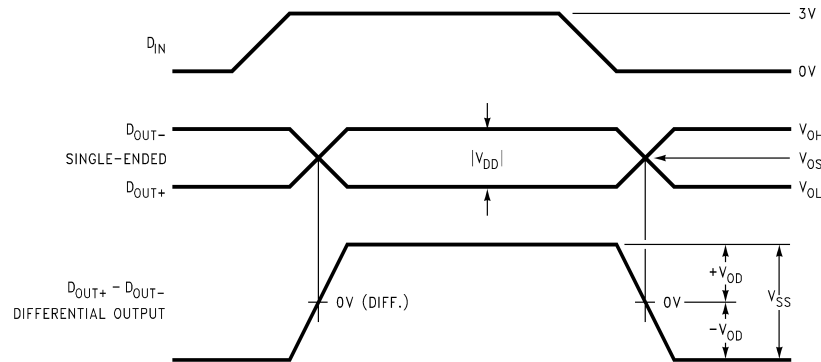

Figure 32. Driver Output Levels

Pin Descriptions

Pin No. (SOIC)	Name	Description
1, 7, 9, 15	D_I	Driver input pin, TTL/CMOS compatible
2, 6, 10, 14	D_{O+}	Non-inverting driver output pin, LVDS levels
3, 5, 11, 13	D_{O-}	Inverting driver output pin, LVDS levels
4	EN	Active high enable pin, OR-ed with EN*
12	EN*	Active low enable pin, OR-ed with EN
16	V_{CC}	Power supply pin, +5V \pm 10%
8	Gnd	Ground pin

Radiation Environments

Careful consideration should be given to environmental conditions when using a product in a radiation environment.

Total Ionizing Dose

Radiation hardness assured (RHA) products are those part numbers with a total ionizing dose (TID) level specified in the Ordering Information table on the front page. Testing and qualification of these products is done on a wafer level according to MIL-STD-883G, Test Method 1019.7, Condition A and the "Extended room temperature anneal test" described in section 3.11 for application environment dose rates less than 0.16 rad(Si)/s. Wafer level TID data is available with lot shipments.

Single Event Latch-Up

One time single event latch-up (SEL) testing was performed showing SEL immunity to 103 MeV-cm²/mg. A test report is available upon request.

Single Event Upset

Single event upset (SEU) data are available upon request.

REVISION HISTORY

Released	Revision	Section	Changes
03/01/06	New	New Release, Corporate format	1 MDS data sheet converted into Corp. data sheet format. MNDS90C031-X-RH Rev 2A1 will be archived.
10/12/2010	A	Features, Ordering Table, Absolute Maximum Ratings, Applications Information	Added reference to Radiation and Fail safe. Removed reference to EOL NSID, Output Voltage changed limit from -0.3V to (V _{CC} + 0.3V) to -0.3V to +5.8V, Added paragraph to Applications Information section and New Radiation Environment section. Revision A will be Archived.
03/04/2013	B	All	Changed layout of National Data Sheet to TI format.

PACKAGING INFORMATION

Orderable Device	Status (1)	Package Type	Package Drawing	Pins	Package Qty	Eco Plan (2)	Lead finish/ Ball material (6)	MSL Peak Temp (3)	Op Temp (°C)	Device Marking (4/5)	Samples
5962-9583301Q2A	ACTIVE	LCCC	NAJ	20	50	RoHS & Green	Call TI	Level-1-NA-UNLIM	-55 to 125	DS90C031E -QML Q 5962-95833 01Q2A ACO 01Q2A >T	Samples
5962-9583301VFA	ACTIVE	CFP	NAD	16	19	Non-RoHS & Green	Call TI	Level-1-NA-UNLIM	-55 to 125	DS90C031W- QMLV Q 5962-95833 01VFA ACO 01VFA >T	Samples
5962R9583301VFA	ACTIVE	CFP	NAD	16	19	Non-RoHS & Green	Call TI	Level-1-NA-UNLIM	-55 to 125	DS90C031WR QMLV Q 5962R95833 01VFA ACO 01VFA >T	Samples
5962R9583301VZA	ACTIVE	CFP	NAC	16	88	Non-RoHS & Green	Call TI	Level-1-NA-UNLIM	-55 to 125	DS90C031WGR QMLV Q 5962R95833 01VZA ACO 01VZA >T	Samples
DS90C031 MDR	ACTIVE	DIESALE	Y	0	28	RoHS & Green	Call TI	Level-1-NA-UNLIM	-55 to 125		Samples
DS90C031E-QML	ACTIVE	LCCC	NAJ	20	50	RoHS & Green	Call TI	Level-1-NA-UNLIM	-55 to 125	DS90C031E -QML Q 5962-95833 01Q2A ACO 01Q2A >T	Samples
DS90C031W-QMLV	ACTIVE	CFP	NAD	16	19	Non-RoHS & Green	Call TI	Level-1-NA-UNLIM	-55 to 125	DS90C031W- QMLV Q 5962-95833 01VFA ACO 01VFA >T	Samples
DS90C031WGRQMLV	ACTIVE	CFP	NAC	16	88	Non-RoHS & Green	Call TI	Level-1-NA-UNLIM	-55 to 125	DS90C031WGR QMLV Q 5962R95833 01VZA ACO 01VZA >T	Samples

Orderable Device	Status (1)	Package Type	Package Drawing	Pins	Package Qty	Eco Plan (2)	Lead finish/ Ball material (6)	MSL Peak Temp (3)	Op Temp (°C)	Device Marking (4/5)	Samples
DS90C031WRQMLV	ACTIVE	CFP	NAD	16	19	Non-RoHS & Green	Call TI	Level-1-NA-UNLIM	-55 to 125	DS90C031WR QMLV Q 5962R95833 01VFA ACO 01VFA >T	Samples

(1) The marketing status values are defined as follows:

ACTIVE: Product device recommended for new designs.

LIFEBUY: TI has announced that the device will be discontinued, and a lifetime-buy period is in effect.

NRND: Not recommended for new designs. Device is in production to support existing customers, but TI does not recommend using this part in a new design.

PREVIEW: Device has been announced but is not in production. Samples may or may not be available.

OBSELETE: TI has discontinued the production of the device.

(2) **RoHS:** TI defines "RoHS" to mean semiconductor products that are compliant with the current EU RoHS requirements for all 10 RoHS substances, including the requirement that RoHS substance do not exceed 0.1% by weight in homogeneous materials. Where designed to be soldered at high temperatures, "RoHS" products are suitable for use in specified lead-free processes. TI may reference these types of products as "Pb-Free".

RoHS Exempt: TI defines "RoHS Exempt" to mean products that contain lead but are compliant with EU RoHS pursuant to a specific EU RoHS exemption.

Green: TI defines "Green" to mean the content of Chlorine (Cl) and Bromine (Br) based flame retardants meet JS709B low halogen requirements of <=1000ppm threshold. Antimony trioxide based flame retardants must also meet the <=1000ppm threshold requirement.

(3) MSL, Peak Temp. - The Moisture Sensitivity Level rating according to the JEDEC industry standard classifications, and peak solder temperature.

(4) There may be additional marking, which relates to the logo, the lot trace code information, or the environmental category on the device.

(5) Multiple Device Markings will be inside parentheses. Only one Device Marking contained in parentheses and separated by a "~" will appear on a device. If a line is indented then it is a continuation of the previous line and the two combined represent the entire Device Marking for that device.

(6) Lead finish/Ball material - Orderable Devices may have multiple material finish options. Finish options are separated by a vertical ruled line. Lead finish/Ball material values may wrap to two lines if the finish value exceeds the maximum column width.

Important Information and Disclaimer:The information provided on this page represents TI's knowledge and belief as of the date that it is provided. TI bases its knowledge and belief on information provided by third parties, and makes no representation or warranty as to the accuracy of such information. Efforts are underway to better integrate information from third parties. TI has taken and continues to take reasonable steps to provide representative and accurate information but may not have conducted destructive testing or chemical analysis on incoming materials and chemicals. TI and TI suppliers consider certain information to be proprietary, and thus CAS numbers and other limited information may not be available for release.

In no event shall TI's liability arising out of such information exceed the total purchase price of the TI part(s) at issue in this document sold by TI to Customer on an annual basis.

OTHER QUALIFIED VERSIONS OF DS90C031QML, DS90C031QML-SP :

- Military : [DS90C031QML](#)
- Space : [DS90C031QML-SP](#)

NOTE: Qualified Version Definitions:

- Military - QML certified for Military and Defense Applications
- Space - Radiation tolerant, ceramic packaging and qualified for use in Space-based application

TUBE

*All dimensions are nominal

Device	Package Name	Package Type	Pins	SPQ	L (mm)	W (mm)	T (μm)	B (mm)
5962-9583301Q2A	NAJ	LCCC	20	50	470	11	3810	0
5962-9583301VF A	NAD	CFP	16	19	502	23	9398	9.78
5962R9583301VF A	NAD	CFP	16	19	502	23	9398	9.78
DS90C031E-QML	NAJ	LCCC	20	50	470	11	3810	0
DS90C031W-QMLV	NAD	CFP	16	19	502	23	9398	9.78
DS90C031WRQMLV	NAD	CFP	16	19	502	23	9398	9.78

EXAMPLE BOARD LAYOUT

NAC0016A

CFP - 2.33mm max height

CERAMIC FLATPACK

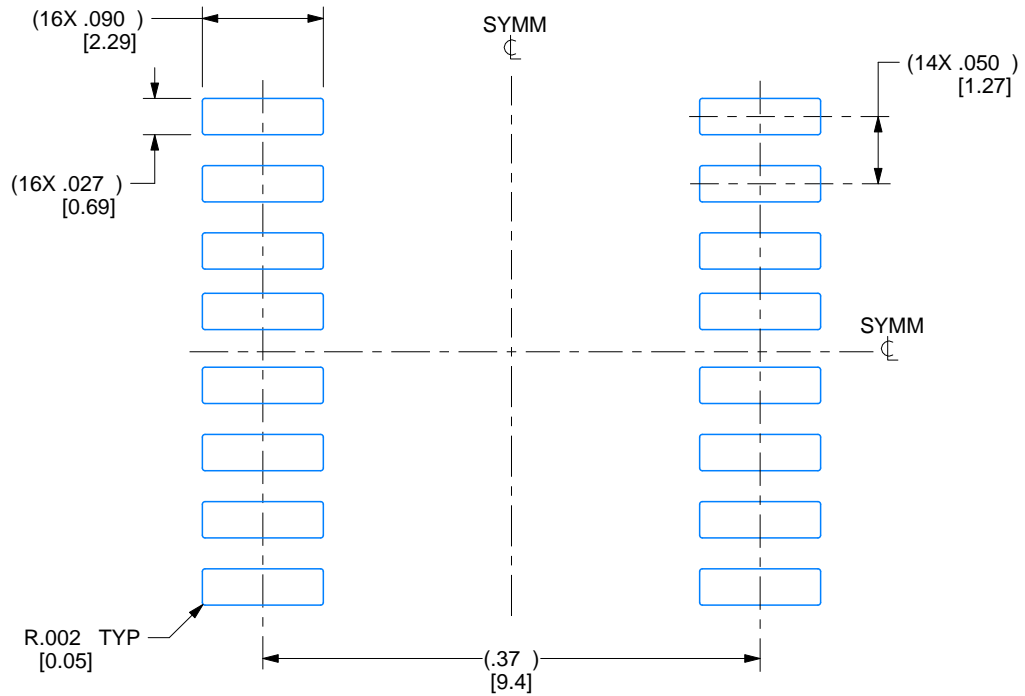

RECOMMENDED LAND PATTERN

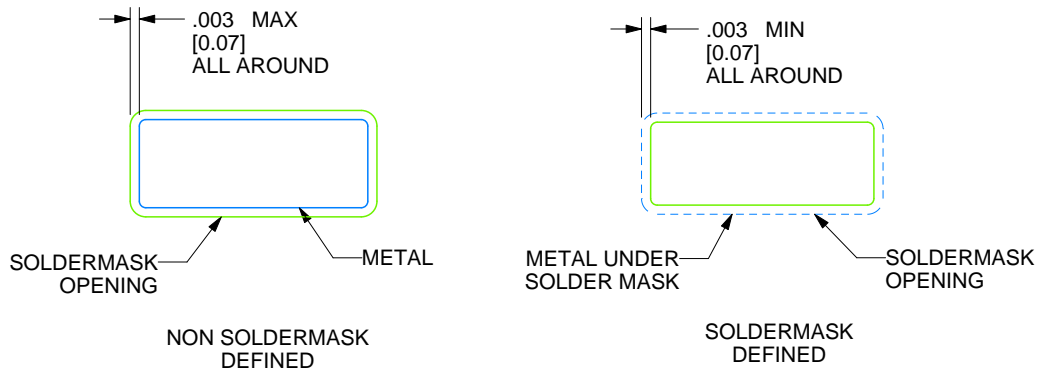

4215198/C 08/2022

REVISIONS

REV	DESCRIPTION	E.C.N.	DATE	BY/APP'D
A	RELEASE TO DOCUMENT CONTROL	2197879	12/30/2021	TINA TRAN / ANIS FAUZI
B	NO CHANGE TO DRAWING; REVISION FOR YODA RELEASE;	2198832	02/15/2022	K. SINCERBOX
C	.387± .003 WAS .39000± .00012;	2200917	08/08/2022	D. CHIN / K. SINCERBOX

NAD0016A

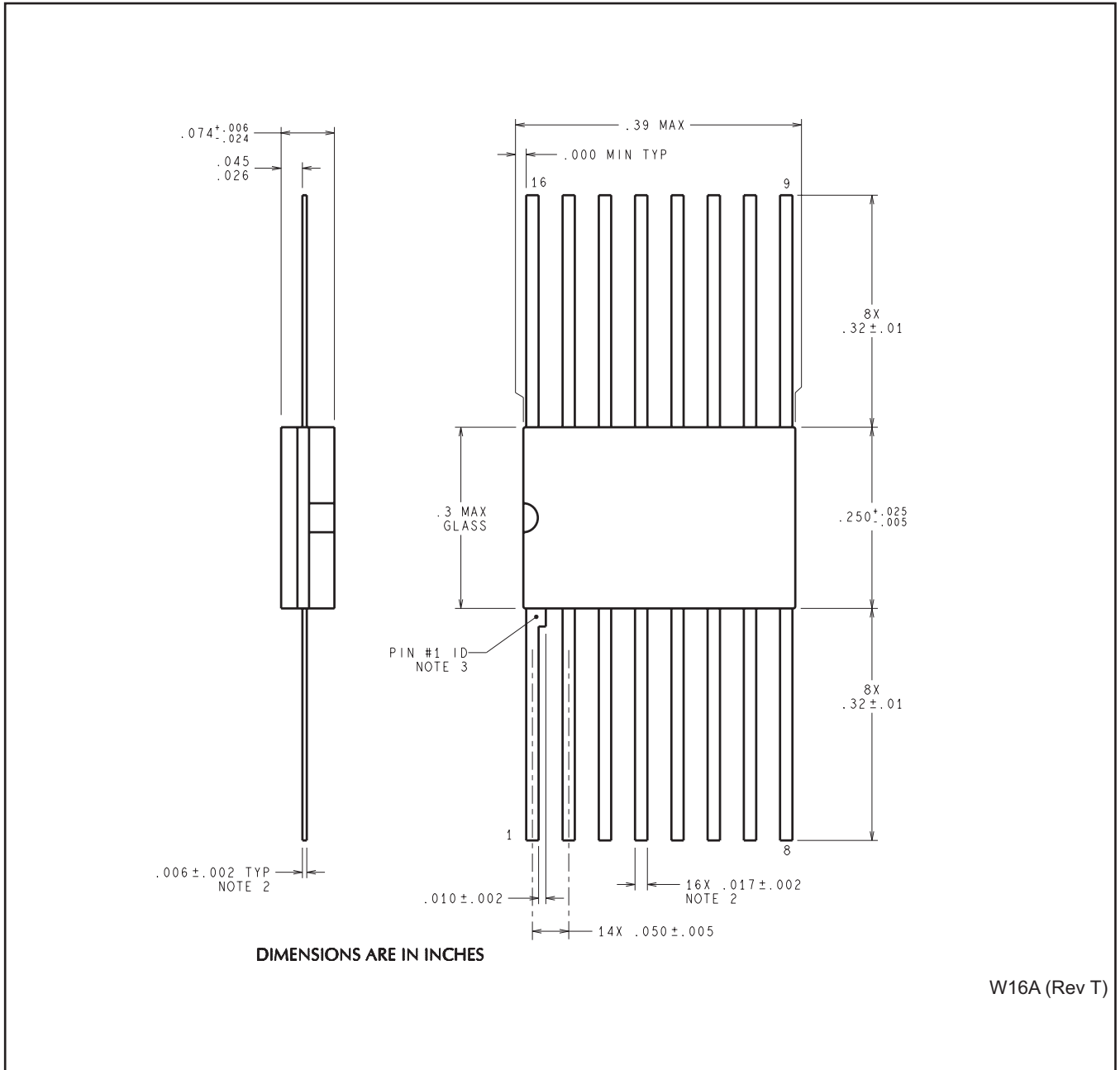

NAJ0020A

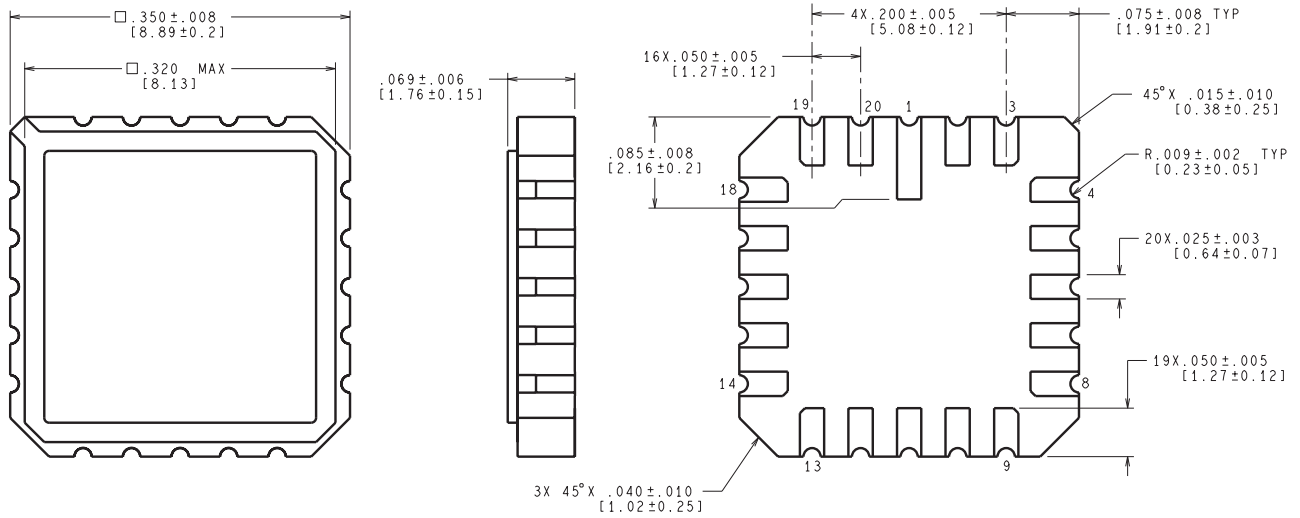

CONTROLLING DIMENSION IS INCH
VALUES IN [] ARE MILLIMETERS

E20A (Rev F)

IMPORTANT NOTICE AND DISCLAIMER

TI PROVIDES TECHNICAL AND RELIABILITY DATA (INCLUDING DATA SHEETS), DESIGN RESOURCES (INCLUDING REFERENCE DESIGNS), APPLICATION OR OTHER DESIGN ADVICE, WEB TOOLS, SAFETY INFORMATION, AND OTHER RESOURCES "AS IS" AND WITH ALL FAULTS, AND DISCLAIMS ALL WARRANTIES, EXPRESS AND IMPLIED, INCLUDING WITHOUT LIMITATION ANY IMPLIED WARRANTIES OF MERCHANTABILITY, FITNESS FOR A PARTICULAR PURPOSE OR NON-INFRINGEMENT OF THIRD PARTY INTELLECTUAL PROPERTY RIGHTS.

These resources are intended for skilled developers designing with TI products. You are solely responsible for (1) selecting the appropriate TI products for your application, (2) designing, validating and testing your application, and (3) ensuring your application meets applicable standards, and any other safety, security, regulatory or other requirements.

These resources are subject to change without notice. TI grants you permission to use these resources only for development of an application that uses the TI products described in the resource. Other reproduction and display of these resources is prohibited. No license is granted to any other TI intellectual property right or to any third party intellectual property right. TI disclaims responsibility for, and you will fully indemnify TI and its representatives against, any claims, damages, costs, losses, and liabilities arising out of your use of these resources.

TI's products are provided subject to [TI's Terms of Sale](#) or other applicable terms available either on [ti.com](https://www.ti.com) or provided in conjunction with such TI products. TI's provision of these resources does not expand or otherwise alter TI's applicable warranties or warranty disclaimers for TI products.

TI objects to and rejects any additional or different terms you may have proposed.

Mailing Address: Texas Instruments, Post Office Box 655303, Dallas, Texas 75265
Copyright © 2023, Texas Instruments Incorporated

Looking for pricing, stock, or lifecycle information?

Click below to explore more details on WIN SOURCE:

 [View DS90C031WGRQMLV on WIN SOURCE](#)

 [Texas Instruments](#) Information

Optimize Your Supply Chain with WIN SOURCE Solutions

-  Global Sourcing Solution
-  Obsolete Management
-  Cost Control Management
-  Shortage Management
-  Alternative Solution
-  Excess Inventory Management