



**THE DATASHEET OF
EE-SX3239-P2**



■ Dimensions

Note: All units are in millimeters unless otherwise indicated.

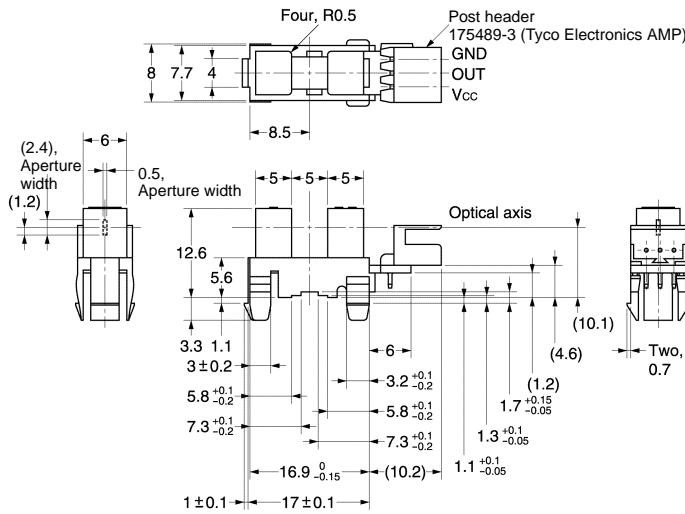

Note: The asterisked dimension is specified by datum A only.

Internal Circuit

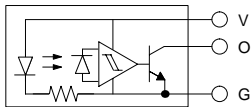

Unless otherwise specified, the tolerances are as shown below.

Dimensions	Tolerance
3 mm max.	±0.3
3 < mm ≤ 6	±0.375
6 < mm ≤ 10	±0.45
10 < mm ≤ 18	±0.55
18 < mm ≤ 30	±0.65

Terminal No.	Name
V	Power supply (V _{CC})
O	Output (OUT)
G	Ground (GND)

Recommended Mating Connectors:
 Tyco Electronics AMP 175778-3 (crimp-type connector)
 173977-3 (press-fit connector)

■ Features

- Snap-in mounting model.
- Mounts to 1.0-, 1.2- and 1.6-mm-thick panels.
- High resolution with a 0.5-mm-wide sensing aperture.
- With a 5-mm-wide slot.
- Photo IC output signals directly connect with C-MOS and TTL.
- Connects to Tyco Electronics AMP's CT-series connectors.

■ Absolute Maximum Ratings (Ta = 25°C)

Item	Symbol	Rated value
Power supply voltage	V _{CC}	7 V
Output voltage	V _{OUT}	28 V
Output current	I _{OUT}	16 mA
Permissible output dissipation	P _{OUT}	250 mW (see note)
Ambient temperature	Operating	T _{opr} -20°C to 75°C
	Storage	T _{stg} -40°C to 85°C
Soldering temperature	T _{sol}	---

Note: Refer to the temperature rating chart if the ambient temperature exceeds 25°C.

■ Electrical and Optical Characteristics (Ta = 25°C, V_{CC} = 5 V ±10%)

Item	Symbol	Value	Condition
Current consumption	I _{CC}	16.5 mA max.	With and without incident
Low-level output voltage	V _{OL}	0.35 V max.	I _{OUT} = 16 mA without incident (EE-SX3239-P2), with incident (EE-SX4239-P2)
High-level output voltage	V _{OH}	(V _{CC} × 0.9) V min.	V _{OUT} = V _{CC} with incident (EE-SX3239-P2), without incident (EE-SX4239-P2), R _L = 47 kΩ
Response frequency	f	3 kHz min.	V _{OUT} = V _{CC} , R _L = 47 kΩ (see note)

Note: The value of the response frequency is measured by rotating the disk as shown below.

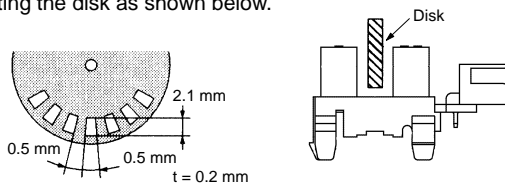

■ Engineering Data

Output Allowable Dissipation vs. Ambient Temperature Characteristics

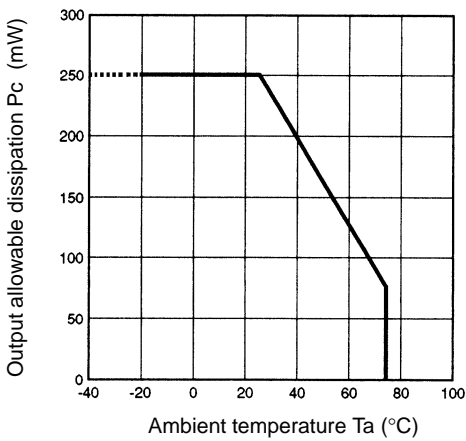

Sensing Position Characteristics (Typical)

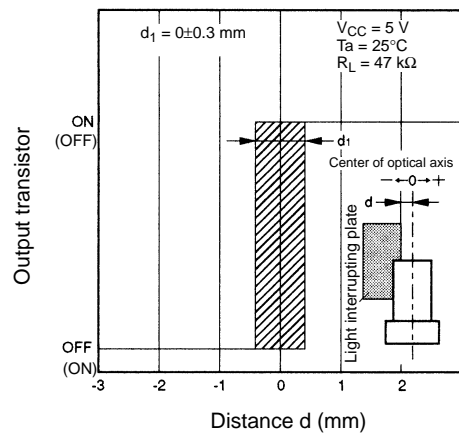

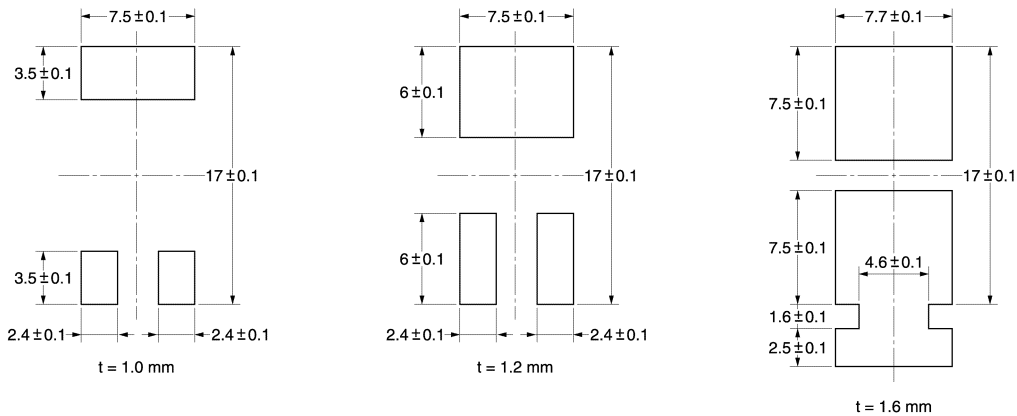

■ Recommended Mounting Holes









- When mounting the Photomicrosensor to a panel with a hole opened by pressing, make sure that the hole has no burrs. The mounting strength of the Photomicrosensor will decrease if the hole has burrs.
- When mounting the Photomicrosensor to a panel with a hole opened by pressing, be sure to mount the Photomicrosensor on the pressing side of the panel.
- The mounting strength of the Photomicrosensor will increase if the Photomicrosensor is mounted to a panel with a hole that is only a little larger than the size of the Photomicrosensor, in which case, however, it will be difficult to mount the Photomicrosensor to the panel. The mounting strength of the Photomicrosensor will decrease if the Photomicrosensor is mounted to a panel with a hole that is comparatively larger than the size of the Photomicrosensor, in which case, however, it will be easy to mount the Photomicrosensor to the panel. When mounting the Photomicrosensor to a panel, open an appropriate hole for the Photomicrosensor according to the application.
- After mounting the Photomicrosensor to any panel, make sure that the Photomicrosensor does not wobble.
- When mounting the Photomicrosensor to a molding with a hole, make sure that the edges of the hole are sharp enough, otherwise the Photomicrosensor may fall out.

Looking for pricing, stock, or lifecycle information?

Click below to explore more details on WIN SOURCE:

-  [View EE-SX3239-P2 on WIN SOURCE](#)
-  [Omron Information](#)

Optimize Your Supply Chain with WIN SOURCE Solutions

-  Global Sourcing Solution
-  Obsolete Management
-  Cost Control Management
-  Shortage Management
-  Alternative Solution
-  Excess Inventory Management