



**THE DATASHEET OF
STTH10002TV1**



Features

- Very low forward losses
- Low recovery time
- High surge current capability
- Insulated package
 - Insulating voltage = 2500 V rms
 - Capacitance = 45 pF
- Complies with UL standards (File ref: E81734)

Description

The STTH10002 is a dual rectifier suited for welding equipment, and high power industrial applications.

Packaged in ISOTOP, this device is intended for use in the secondary rectification of power converters.

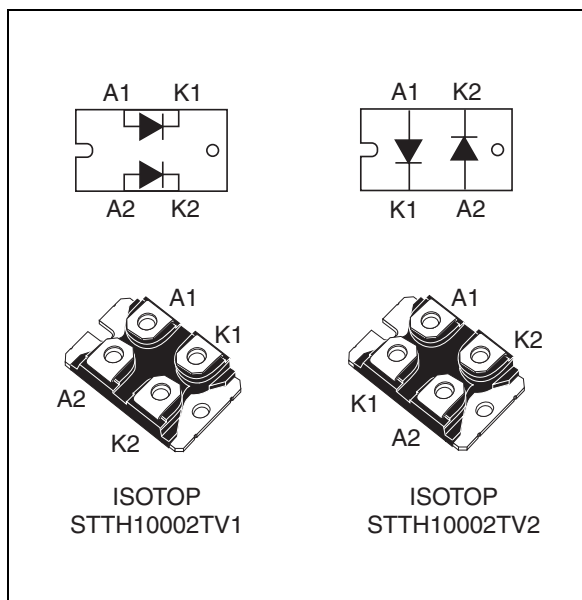

Table 1. Device summary

$I_{F(AV)}$	2 x 50 A
V_{RRM}	200 V
T_j (max)	150 °C
V_F (typ)	0.72 V
t_{rr} (typ)	30 ns

1 Characteristics

Table 2. Absolute ratings (limiting values at $T_j = 25\text{ °C}$, unless otherwise specified)

Symbol	Parameter		Value	Unit
V_{RRM}	Repetitive peak reverse voltage		200	V
$I_{F(RMS)}$	Forward rms current	Per diode	150	A
$I_{F(AV)}$	Average forward current, $\delta = 0.5$	Per diode $T_c = 100\text{ °C}$	50	A
		Per device $T_c = 95\text{ °C}$		
I_{FSM}	Surge non repetitive forward current	$t_p = 10\text{ ms}$ sinusoidal	750	A
T_{stg}	Storage temperature range		-55 to + 150	°C
T_j	Maximum operating junction temperature		150	°C

Table 3. Thermal parameters

Symbol	Parameter		Value	Unit
$R_{th(j-c)}$	Junction to case	Per diode	1	°C/W
		Total	0.55	
$R_{th(c)}$	Coupling		0.1	

When the two diodes 1 and 2 are used simultaneously:

$$\Delta T_j(\text{diode 1}) = P(\text{diode 1}) \times R_{th(j-c)} (\text{Per diode}) + P(\text{diode 2}) \times R_{th(c)}$$

Table 4. Static electrical characteristics

Symbol	Parameter	Test conditions	Min.	Typ.	Max.	Unit	
$I_R^{(1)}$	Reverse leakage current	$T_j = 25\text{ °C}$	$V_R = V_{RRM}$	-	-	50	μA
		$T_j = 125\text{ °C}$		-	50	500	
$V_F^{(2)}$	Forward voltage drop	$T_j = 25\text{ °C}$	$I_F = 50\text{ A}$	-	-	1	V
			$I_F = 100\text{ A}$	-	-	1.15	
		$T_j = 125\text{ °C}$	$I_F = 100\text{ A}$	-	0.90	1.0	
			$T_j = 150\text{ °C}$	$I_F = 50\text{ A}$	-	0.72	
$I_F = 100\text{ A}$	-	0.86		0.97			

1. Pulse test: $t_p = 5\text{ ms}$, $\delta < 2\%$

2. Pulse test: $t_p = 380\text{ }\mu\text{s}$, $\delta < 2\%$

To evaluate the conduction losses use the following equation:

$$P = 0.63 \times I_{F(AV)} + 0.0034 I_{F(RMS)}^2$$

Table 5. Dynamic characteristics

Symbol	Parameter	Test conditions	Min.	Typ.	Max.	Unit
t_{rr}	Reverse recovery time	$I_F = 1 \text{ A}$, $di_F/dt = -50 \text{ A}/\mu\text{s}$, $V_R = 30 \text{ V}$, $T_j = 25 \text{ }^\circ\text{C}$	-	53	65	ns
		$I_F = 1 \text{ A}$, $di_F/dt = -200 \text{ A}/\mu\text{s}$, $V_R = 30 \text{ V}$, $T_j = 25 \text{ }^\circ\text{C}$	-	30	37	
I_{RM}	Reverse recovery current	$I_F = 50 \text{ A}$, $di_F/dt = 200 \text{ A}/\mu\text{s}$, $V_R = 160 \text{ V}$, $T_j = 125 \text{ }^\circ\text{C}$	-	10	13	A
t_{fr}	Forward recovery time	$I_F = 50 \text{ A}$, $di_F/dt = 200 \text{ A}/\mu\text{s}$ $V_{FR} = 1.1 \times V_{Fmax}$, $T_j = 25 \text{ }^\circ\text{C}$	-	180	-	ns
V_{FP}	Forward recovery voltage	$I_F = 50 \text{ A}$, $di_F/dt = 200 \text{ A}/\mu\text{s}$, $T_j = 25 \text{ }^\circ\text{C}$	-	1.6	-	V

Figure 1. Peak current versus duty cycle

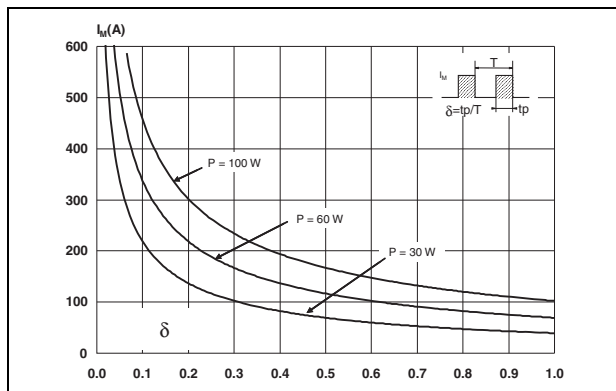

Figure 3. Forward voltage drop versus forward current (maximum values, per diode)

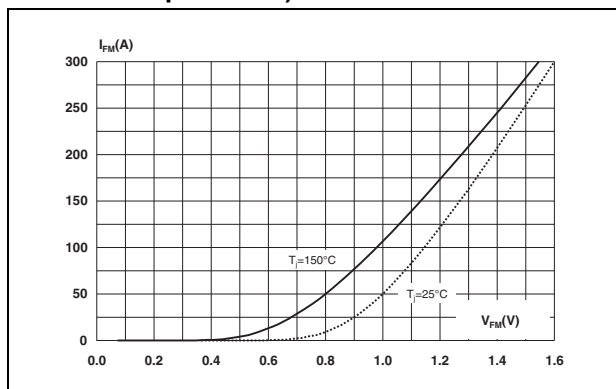

Figure 2. Forward voltage drop versus forward current (typical values, per diode)

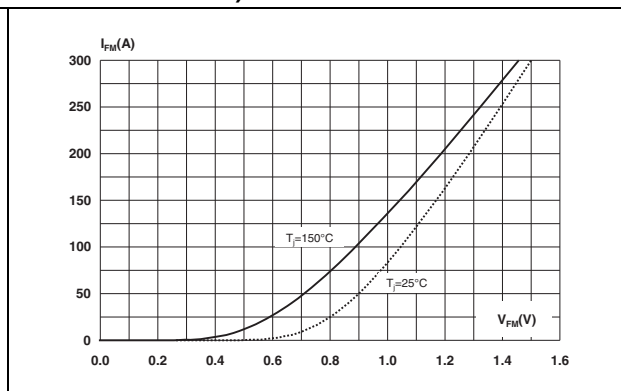

Figure 4. Relative variation of thermal impedance, junction to case, versus pulse duration

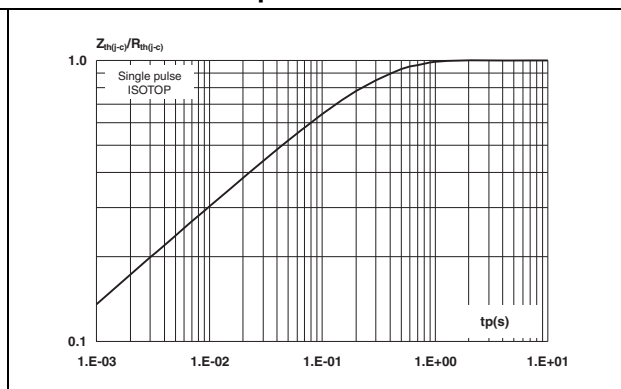

Figure 5. Junction capacitance versus reverse applied voltage (typical values)

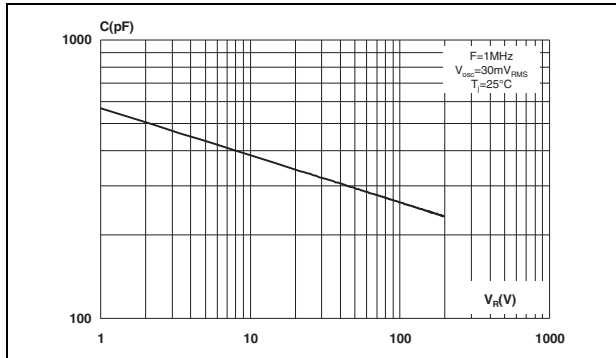

Figure 6. Reverse recovery charges versus di_F/dt (typical values)

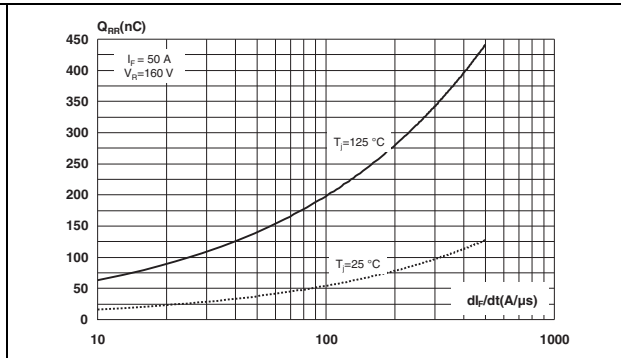

Figure 7. Reverse recovery time versus di_F/dt (typical values)

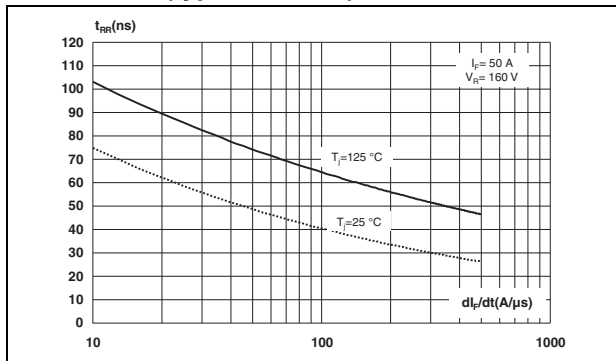

Figure 8. Peak reverse recovery current versus di_F/dt (typical values)

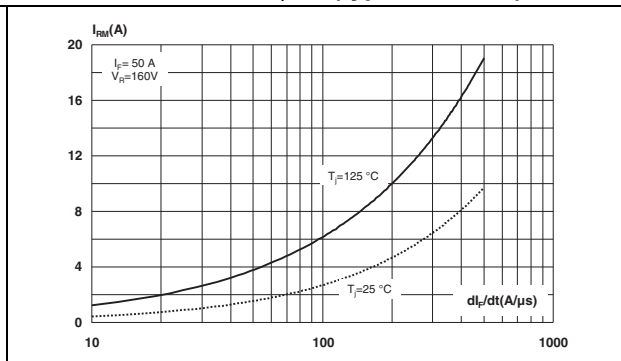
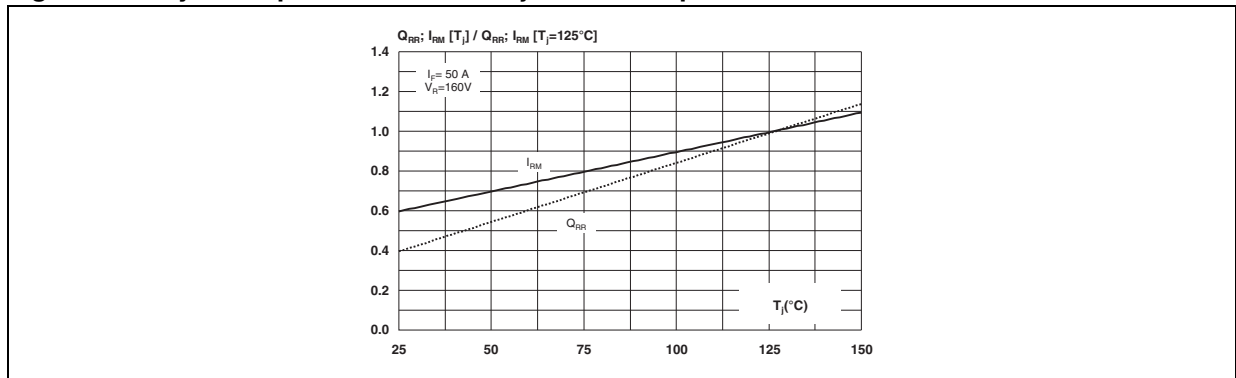
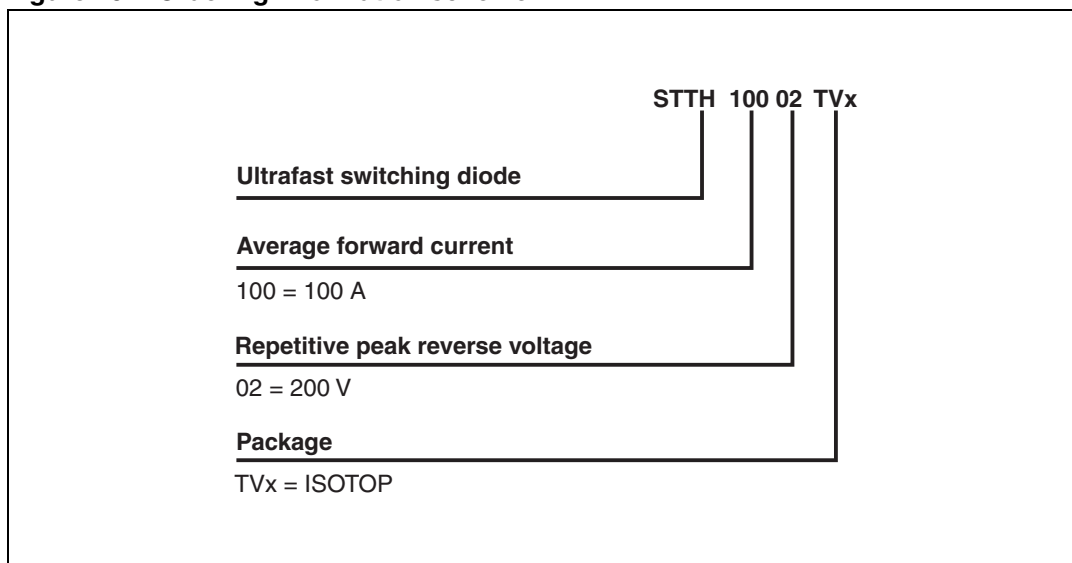

Figure 9. Dynamic parameters versus junction temperature



2 Ordering information scheme

Figure 10. Ordering information scheme



3 Package information

- Epoxy meets UL94, V0
- Cooling method: by conduction (C)

In order to meet environmental requirements, ST offers these devices in different grades of ECOPACK® packages, depending on their level of environmental compliance. ECOPACK® specifications, grade definitions and product status are available at: www.st.com. ECOPACK® is an ST trademark.

Table 6. ISOTOP dimensions

Ref.	Dimensions			
	Millimeters		Inches	
	Min.	Max.	Min.	Max.
A	11.80	12.20	0.465	0.480
A1	8.90	9.10	0.350	0.358
B	7.8	8.20	0.307	0.323
C	0.75	0.85	0.030	0.033
C2	1.95	2.05	0.077	0.081
D	37.80	38.20	1.488	1.504
D1	31.50	31.70	1.240	1.248
E	25.15	25.50	0.990	1.004
E1	23.85	24.15	0.939	0.951
E2	24.80 typ.		0.976 typ.	
G	14.90	15.10	0.587	0.594
G1	12.60	12.80	0.496	0.504
G2	3.50	4.30	0.138	0.169
F	4.10	4.30	0.161	0.169
F1	4.60	5.00	0.181	0.197
P	4.00	4.30	0.157	0.69
P1	4.00	4.40	0.157	0.173
S	30.10	30.30	1.185	1.193

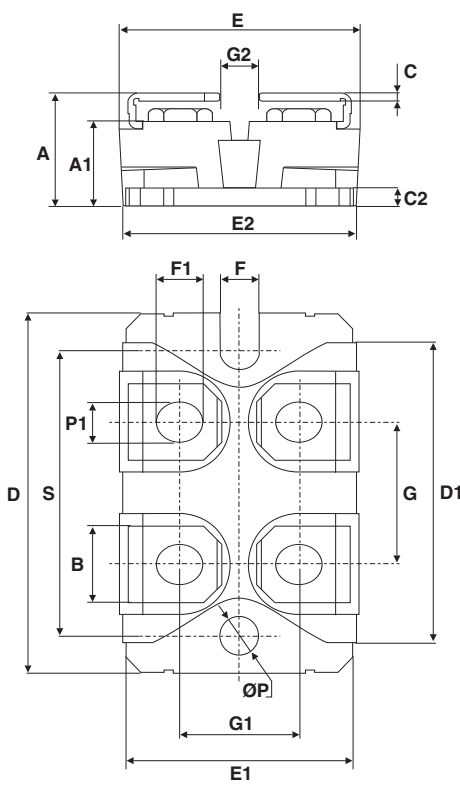

4 Ordering information

Table 7. Ordering information

Order code	Marking	Package	Weight	Base qty ⁽¹⁾	Delivery mode
STTH10002TV1	STTH10002TV1	ISOTOP	27 g	10 with screws	Tube
STTH10002TV2	STTH10002TV2				

1. This product is supplied with 40 terminal screws and washers for each tube. The screws and washers are supplied in a separate pack with the order.

5 Revision history

Table 8. Document revision history

Date	Revision	Changes
05-Apr-2006	1	First issue
23-Oct-2012	2	Added UL file reference. Updated storage temperature range in Table 2 . Added footnote to Table 7 .

Please Read Carefully:

Information in this document is provided solely in connection with ST products. STMicroelectronics NV and its subsidiaries ("ST") reserve the right to make changes, corrections, modifications or improvements, to this document, and the products and services described herein at any time, without notice.

All ST products are sold pursuant to ST's terms and conditions of sale.

Purchasers are solely responsible for the choice, selection and use of the ST products and services described herein, and ST assumes no liability whatsoever relating to the choice, selection or use of the ST products and services described herein.

No license, express or implied, by estoppel or otherwise, to any intellectual property rights is granted under this document. If any part of this document refers to any third party products or services it shall not be deemed a license grant by ST for the use of such third party products or services, or any intellectual property contained therein or considered as a warranty covering the use in any manner whatsoever of such third party products or services or any intellectual property contained therein.

UNLESS OTHERWISE SET FORTH IN ST'S TERMS AND CONDITIONS OF SALE ST DISCLAIMS ANY EXPRESS OR IMPLIED WARRANTY WITH RESPECT TO THE USE AND/OR SALE OF ST PRODUCTS INCLUDING WITHOUT LIMITATION IMPLIED WARRANTIES OF MERCHANTABILITY, FITNESS FOR A PARTICULAR PURPOSE (AND THEIR EQUIVALENTS UNDER THE LAWS OF ANY JURISDICTION), OR INFRINGEMENT OF ANY PATENT, COPYRIGHT OR OTHER INTELLECTUAL PROPERTY RIGHT.

UNLESS EXPRESSLY APPROVED IN WRITING BY TWO AUTHORIZED ST REPRESENTATIVES, ST PRODUCTS ARE NOT RECOMMENDED, AUTHORIZED OR WARRANTED FOR USE IN MILITARY, AIR CRAFT, SPACE, LIFE SAVING, OR LIFE SUSTAINING APPLICATIONS, NOR IN PRODUCTS OR SYSTEMS WHERE FAILURE OR MALFUNCTION MAY RESULT IN PERSONAL INJURY, DEATH, OR SEVERE PROPERTY OR ENVIRONMENTAL DAMAGE. ST PRODUCTS WHICH ARE NOT SPECIFIED AS "AUTOMOTIVE GRADE" MAY ONLY BE USED IN AUTOMOTIVE APPLICATIONS AT USER'S OWN RISK.

Resale of ST products with provisions different from the statements and/or technical features set forth in this document shall immediately void any warranty granted by ST for the ST product or service described herein and shall not create or extend in any manner whatsoever, any liability of ST.

ST and the ST logo are trademarks or registered trademarks of ST in various countries.

Information in this document supersedes and replaces all information previously supplied.

The ST logo is a registered trademark of STMicroelectronics. All other names are the property of their respective owners.

© 2012 STMicroelectronics - All rights reserved



STMicroelectronics group of companies

Australia - Belgium - Brazil - Canada - China - Czech Republic - Finland - France - Germany - Hong Kong - India - Israel - Italy - Japan - Malaysia - Malta - Morocco - Philippines - Singapore - Spain - Sweden - Switzerland - United Kingdom - United States of America

www.st.com

Looking for pricing, stock, or lifecycle information?

Click below to explore more details on WIN SOURCE:

-  [View STTH10002TV1](#) on WIN SOURCE
-  [STMicroelectronics](#) Information

Optimize Your Supply Chain with WIN SOURCE Solutions

-  Global Sourcing Solution
-  Obsolete Management
-  Cost Control Management
-  Shortage Management
-  Alternative Solution
-  Excess Inventory Management