



**THE DATASHEET OF  
NCV33274ADG**



# MC33272A, MC33274A, NCV33272A, NCV33274A



ON Semiconductor®

<http://onsemi.com>

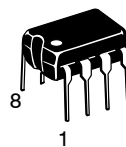
## Operational Amplifiers, Single Supply, High Slew Rate, Low Input Offset Voltage

The MC33272/74 series of monolithic operational amplifiers are quality fabricated with innovative Bipolar design concepts. This dual and quad operational amplifier series incorporates Bipolar inputs along with a patented Zip-R-Trim element for input offset voltage reduction. The MC33272/74 series of operational amplifiers exhibits low input offset voltage and high gain bandwidth product. Dual-doublet frequency compensation is used to increase the slew rate while maintaining low input noise characteristics. Its all NPN output stage exhibits no deadband crossover distortion, large output voltage swing, and an excellent phase and gain margin. It also provides a low open loop high frequency output impedance with symmetrical source and sink AC frequency performance.

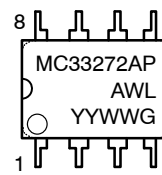
### Features

- Input Offset Voltage Trimmed to 100  $\mu$ V (Typ)
- Low Input Bias Current: 300 nA
- Low Input Offset Current: 3.0 nA
- High Input Resistance: 16 M $\Omega$
- Low Noise: 18 nV/ $\sqrt{\text{Hz}}$  @ 1.0 kHz
- High Gain Bandwidth Product: 24 MHz @ 100 kHz
- High Slew Rate: 10 V/ $\mu$ s
- Power Bandwidth: 160 kHz
- Excellent Frequency Stability
- Unity Gain Stable: w/Capacitance Loads to 500 pF
- Large Output Voltage Swing: +14.1 V/ -14.6 V
- Low Total Harmonic Distortion: 0.003%
- Power Supply Drain Current: 2.15 mA per Amplifier
- Single or Split Supply Operation: +3.0 V to +36 V or  $\pm$ 1.5 V to  $\pm$ 18 V
- ESD Diodes Provide Added Protection to the Inputs
- NCV Prefix for Automotive and Other Applications Requiring Unique Site and Control Change Requirements; AEC-Q100 Qualified and PPAP Capable
- Pb-Free Packages are Available

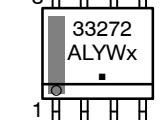
### DUAL MARKING DIAGRAMS



PDIP-8  
P SUFFIX  
CASE 626

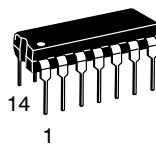


SOIC-8  
D SUFFIX  
CASE 751

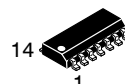
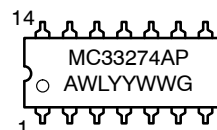


x = A for MC33272AD/DR2  
= N for NCV33272ADR2

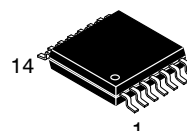
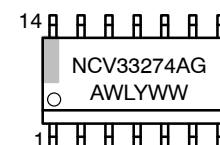
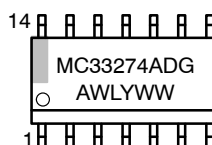
### QUAD



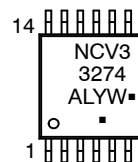
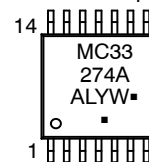
PDIP-14  
P SUFFIX  
CASE 646



SOIC-14  
D SUFFIX  
CASE 751A



TSSOP-14  
DTB SUFFIX  
CASE 948G



A = Assembly Location  
WL, L = Wafer Lot  
YY, Y = Year  
WW, W = Work Week  
G or ▪ = Pb-Free Package

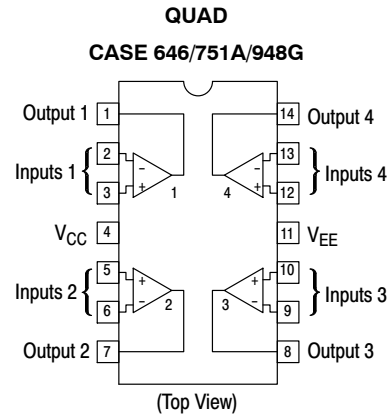
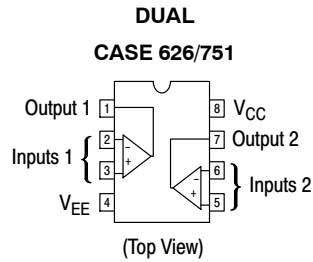
(Note: Microdot may be in either location)

### ORDERING INFORMATION

See detailed ordering and shipping information in the package dimensions section on page 11 of this data sheet.

# MC33272A, MC33274A, NCV33272A, NCV33274A

## PIN CONNECTIONS



## MAXIMUM RATINGS

Rating	Symbol	Value	Unit
Supply Voltage	V <sub>CC</sub> to V <sub>EE</sub>	+36	V
Input Differential Voltage Range	V <sub>IDR</sub>	Note 1	V
Input Voltage Range	V <sub>IR</sub>	Note 1	V
Output Short Circuit Duration (Note 2)	t <sub>SC</sub>	Indefinite	sec
Maximum Junction Temperature	T <sub>J</sub>	+150	°C
Storage Temperature	T <sub>stg</sub>	-60 to +150	°C
ESD Protection at Any Pin	V <sub>esd</sub>	2000 200	V
	- Human Body Model - Machine Model		
Maximum Power Dissipation	P <sub>D</sub>	Note 2	mW
Operating Temperature Range	T <sub>A</sub>	-40 to +85 -40 to +125	°C
	MC33272A, MC33274A NCV33272A, NCV33274A		

Stresses exceeding Maximum Ratings may damage the device. Maximum Ratings are stress ratings only. Functional operation above the Recommended Operating Conditions is not implied. Extended exposure to stresses above the Recommended Operating Conditions may affect device reliability.

1. Either or both input voltages should not exceed V<sub>CC</sub> or V<sub>EE</sub>.
2. Power dissipation must be considered to ensure maximum junction temperature (T<sub>J</sub>) is not exceeded (see Figure 2).

# MC33272A, MC33274A, NCV33272A, NCV33274A

## DC ELECTRICAL CHARACTERISTICS ( $V_{CC} = +15\text{ V}$ , $V_{EE} = -15\text{ V}$ , $T_A = 25^\circ\text{C}$ , unless otherwise noted.)

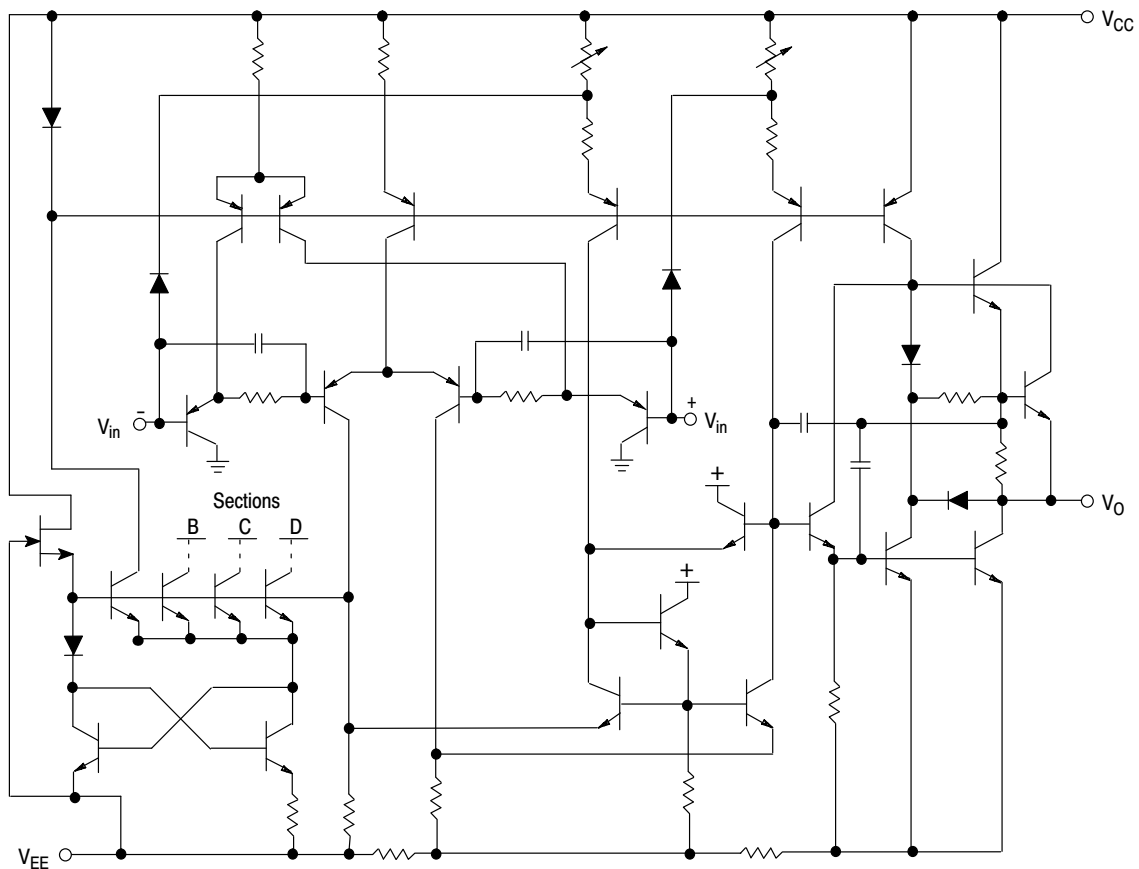
Characteristics	Figure	Symbol	Min	Typ	Max	Unit
Input Offset Voltage ( $R_S = 10\ \Omega$ , $V_{CM} = 0\text{ V}$ , $V_O = 0\text{ V}$ ) ( $V_{CC} = +15\text{ V}$ , $V_{EE} = -15\text{ V}$ ) $T_A = +25^\circ\text{C}$ $T_A = -40^\circ\text{ to }+85^\circ\text{C}$ $T_A = -40^\circ\text{ to }+125^\circ\text{C}$ (NCV33272A) $T_A = -40^\circ\text{ to }+125^\circ\text{C}$ (NCV33274A) ( $V_{CC} = 5.0\text{ V}$ , $V_{EE} = 0\text{ V}$ ) $T_A = +25^\circ\text{C}$	3	$ V_{IO} $	-	0.1	1.0	mV
Average Temperature Coefficient of Input Offset Voltage $R_S = 10\ \Omega$ , $V_{CM} = 0\text{ V}$ , $V_O = 0\text{ V}$ , $T_A = -40^\circ\text{ to }+125^\circ\text{C}$	3	$\Delta V_{IO}/\Delta T$	-	2.0	-	$\mu\text{V}/^\circ\text{C}$
Input Bias Current ( $V_{CM} = 0\text{ V}$ , $V_O = 0\text{ V}$ ) $T_A = +25^\circ\text{C}$ $T_A = T_{low}\text{ to }T_{high}$	4, 5	$I_{IB}$	-	300	650	nA
Input Offset Current ( $V_{CM} = 0\text{ V}$ , $V_O = 0\text{ V}$ ) $T_A = +25^\circ\text{C}$ $T_A = T_{low}\text{ to }T_{high}$		$ I_{IO} $	-	3.0	65	nA
Common Mode Input Voltage Range ( $\Delta V_{IO} = 5.0\text{ mV}$ , $V_O = 0\text{ V}$ ) $T_A = +25^\circ\text{C}$	6	$V_{ICR}$	$V_{EE}\text{ to } (V_{CC} - 1.8)$			V
Large Signal Voltage Gain ( $V_O = 0\text{ V to }10\text{ V}$ , $R_L = 2.0\text{ k}\Omega$ ) $T_A = +25^\circ\text{C}$ $T_A = T_{low}\text{ to }T_{high}$	7	$A_{VOL}$	90 86	100 -	- -	dB
Output Voltage Swing ( $V_{ID} = \pm 1.0\text{ V}$ ) ( $V_{CC} = +15\text{ V}$ , $V_{EE} = -15\text{ V}$ ) $R_L = 2.0\text{ k}\Omega$ $R_L = 2.0\text{ k}\Omega$ $R_L = 10\text{ k}\Omega$ $R_L = 10\text{ k}\Omega$ ( $V_{CC} = 5.0\text{ V}$ , $V_{EE} = 0\text{ V}$ ) $R_L = 2.0\text{ k}\Omega$ $R_L = 2.0\text{ k}\Omega$	8, 9, 12     10, 11	$V_{O+}$ $V_{O-}$ $V_{O+}$ $V_{O-}$  $V_{OL}$ $V_{OH}$	13.4 - 13.4 -  - 3.7	13.9 -13.9 14 -14.7  - -	- -13.5 - -14.1  0.2 5.0	V
Common Mode Rejection ( $V_{in} = +13.2\text{ V to }-15\text{ V}$ )	13	CMR	80	100	-	dB
Power Supply Rejection $V_{CC}/V_{EE} = +15\text{ V}/-15\text{ V}$ , $+5.0\text{ V}/-15\text{ V}$ , $+15\text{ V}/-5.0\text{ V}$	14, 15	PSR	80	105	-	dB
Output Short Circuit Current ( $V_{ID} = 1.0\text{ V}$ , Output to Ground) Source Sink	16	$I_{SC}$	+25 -25	+37 -37	- -	mA
Power Supply Current Per Amplifier ( $V_O = 0\text{ V}$ ) ( $V_{CC} = +15\text{ V}$ , $V_{EE} = -15\text{ V}$ ) $T_A = +25^\circ\text{C}$ $T_A = T_{low}\text{ to }T_{high}$ ( $V_{CC} = 5.0\text{ V}$ , $V_{EE} = 0\text{ V}$ ) $T_A = +25^\circ\text{C}$	17	$I_{CC}$	-	2.15	2.75	mA
			-	-	3.0	
			-	-	2.75	

3. MC33272A, MC33274A  $T_{low} = -40^\circ\text{C}$   $T_{high} = +85^\circ\text{C}$   
 NCV33272A, NCV33274A  $T_{low} = -40^\circ\text{C}$   $T_{high} = +125^\circ\text{C}$

# MC33272A, MC33274A, NCV33272A, NCV33274A

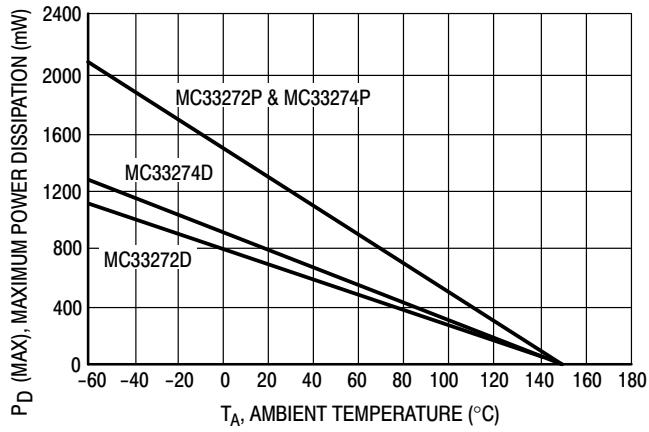
**AC ELECTRICAL CHARACTERISTICS** ( $V_{CC} = +15\text{ V}$ ,  $V_{EE} = -15\text{ V}$ ,  $T_A = 25^\circ\text{C}$ , unless otherwise noted.)

Characteristics	Figure	Symbol	Min	Typ	Max	Unit
Slew Rate ( $V_{in} = -10\text{ V}$ to $+10\text{ V}$ , $R_L = 2.0\text{ k}\Omega$ , $C_L = 100\text{ pF}$ , $A_V = +1.0\text{ V}$ )	18, 33	SR	8.0	10	-	$\text{V}/\mu\text{s}$
Gain Bandwidth Product ( $f = 100\text{ kHz}$ )	19	GBW	17	24	-	MHz
AC Voltage Gain ( $R_L = 2.0\text{ k}\Omega$ , $V_O = 0\text{ V}$ , $f = 20\text{ kHz}$ )	20, 21, 22	$A_{VO}$	-	65	-	dB
Unity Gain Bandwidth (Open Loop)		BW	-	5.5	-	MHz
Gain Margin ( $R_L = 2.0\text{ k}\Omega$ , $C_L = 0\text{ pF}$ )	23, 24, 26	$A_m$	-	12	-	dB
Phase Margin ( $R_L = 2.0\text{ k}\Omega$ , $C_L = 0\text{ pF}$ )	23, 25, 26	$\phi_m$	-	55	-	Deg
Channel Separation ( $f = 20\text{ Hz}$ to $20\text{ kHz}$ )	27	CS	-	-120	-	dB
Power Bandwidth ( $V_O = 20\text{ V}_{pp}$ , $R_L = 2.0\text{ k}\Omega$ , $\text{THD} \leq 1.0\%$ )		$\text{BW}_P$	-	160	-	kHz
Total Harmonic Distortion ( $R_L = 2.0\text{ k}\Omega$ , $f = 20\text{ Hz}$ to $20\text{ kHz}$ , $V_O = 3.0\text{ V}_{rms}$ , $A_V = +1.0$ )	28	THD	-	0.003	-	%
Open Loop Output Impedance ( $V_O = 0\text{ V}$ , $f = 6.0\text{ MHz}$ )	29	$ Z_O $	-	35	-	$\Omega$
Differential Input Resistance ( $V_{CM} = 0\text{ V}$ )		$R_{in}$	-	16	-	$\text{M}\Omega$
Differential Input Capacitance ( $V_{CM} = 0\text{ V}$ )		$C_{in}$	-	3.0	-	pF
Equivalent Input Noise Voltage ( $R_S = 100\ \Omega$ , $f = 1.0\text{ kHz}$ )	30	$e_n$	-	18	-	$\text{nV}/\sqrt{\text{Hz}}$
Equivalent Input Noise Current ( $f = 1.0\text{ kHz}$ )	31	$i_n$	-	0.5	-	$\text{pA}/\sqrt{\text{Hz}}$

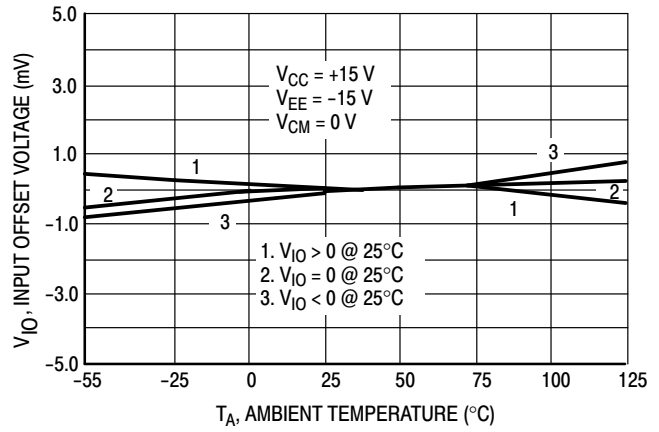


**Figure 1. Equivalent Circuit Schematic**  
(Each Amplifier)

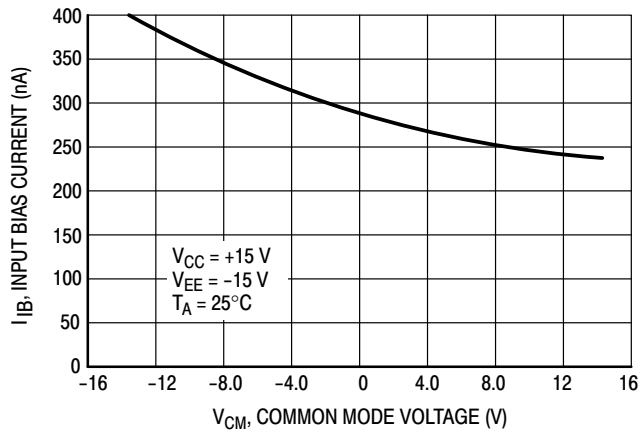
# MC33272A, MC33274A, NCV33272A, NCV33274A



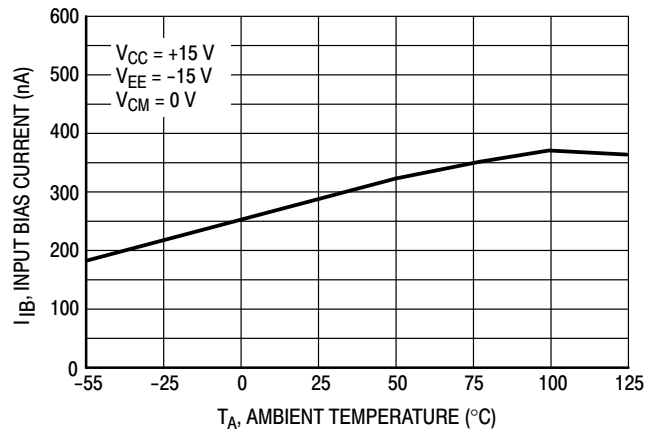
**Figure 2. Maximum Power Dissipation versus Temperature**



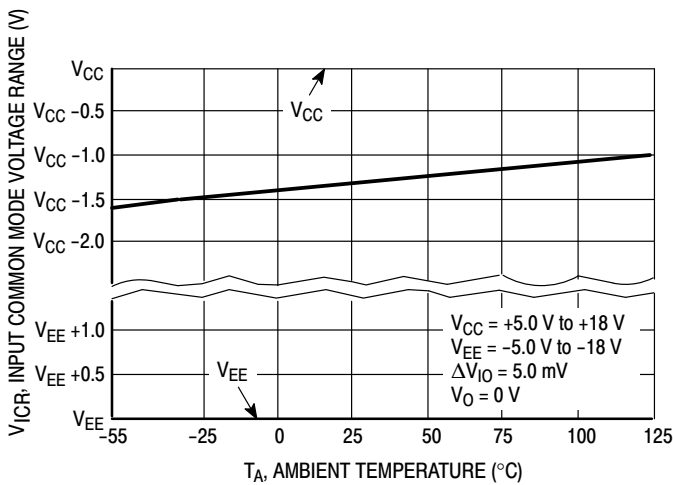
**Figure 3. Input Offset Voltage versus Temperature for Typical Units**



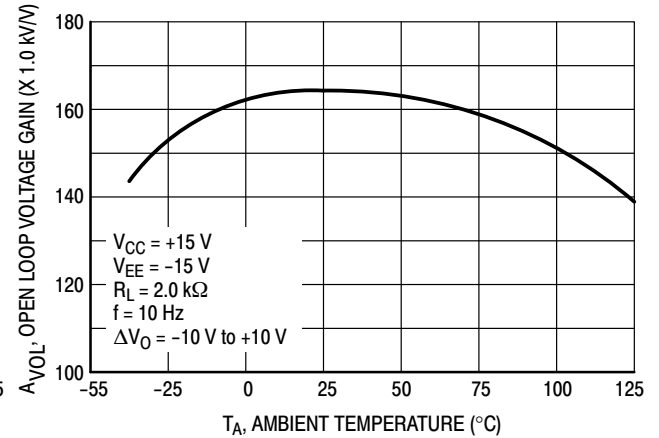
**Figure 4. Input Bias Current versus Common Mode Voltage**



**Figure 5. Input Bias Current versus Temperature**



**Figure 6. Input Common Mode Voltage Range versus Temperature**



**Figure 7. Open Loop Voltage Gain versus Temperature**

MC33272A, MC33274A, NCV33272A, NCV33274A

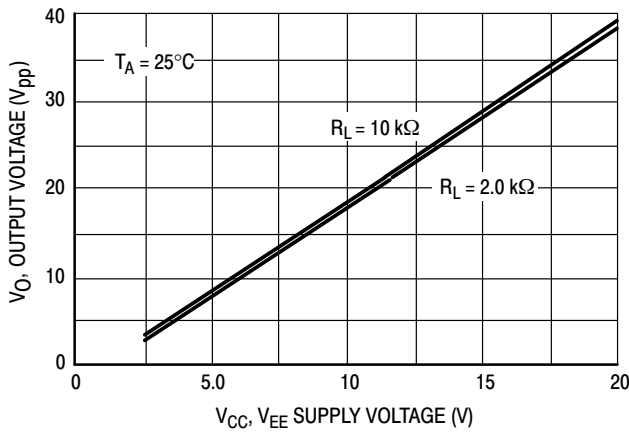


Figure 8. Split Supply Output Voltage Swing versus Supply Voltage

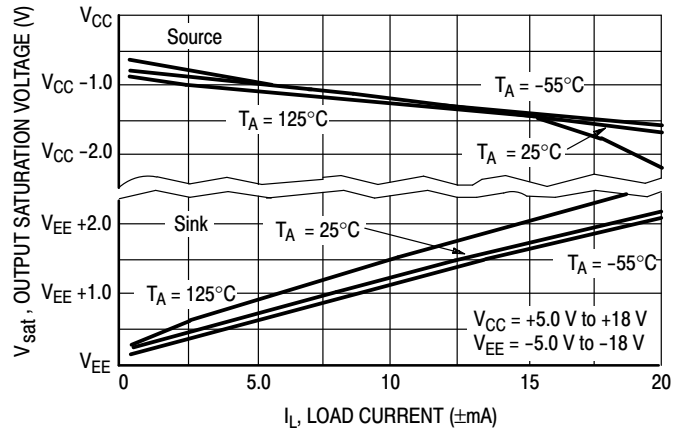


Figure 9. Split Supply Output Saturation Voltage versus Load Current

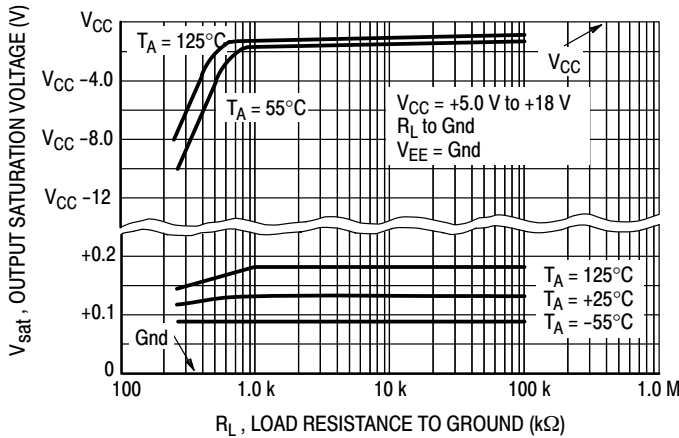


Figure 10. Single Supply Output Saturation Voltage versus Load Resistance to Ground

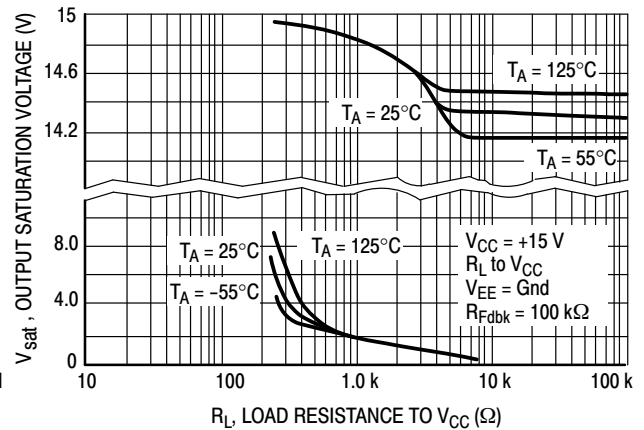


Figure 11. Single Supply Output Saturation Voltage versus Load Resistance to V<sub>CC</sub>

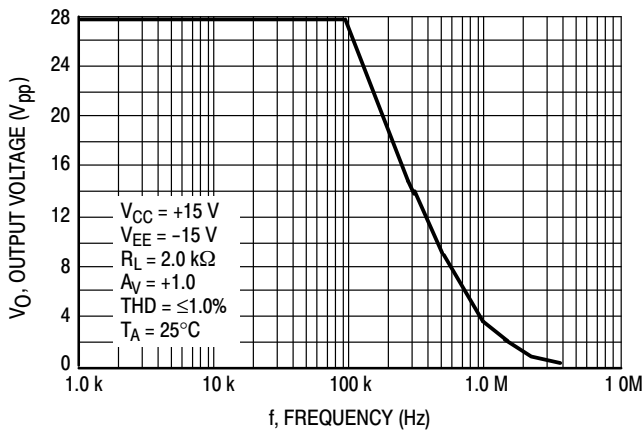


Figure 12. Output Voltage versus Frequency

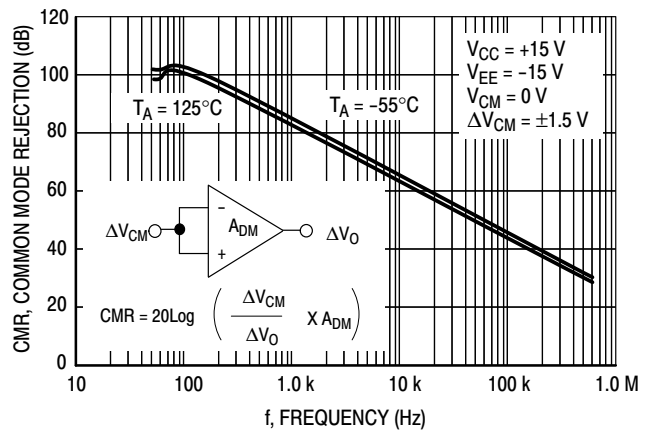


Figure 13. Common Mode Rejection versus Frequency

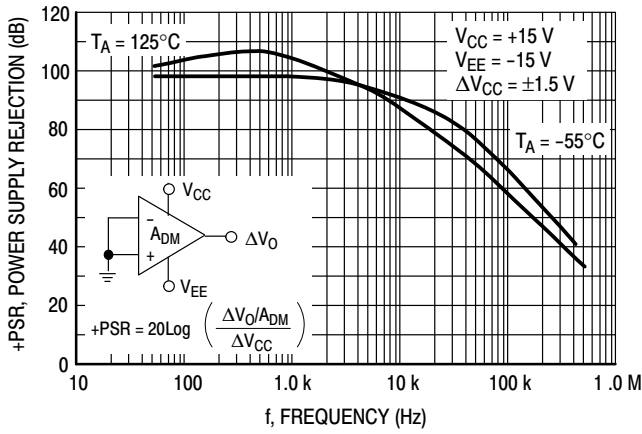


Figure 14. Positive Power Supply Rejection versus Frequency

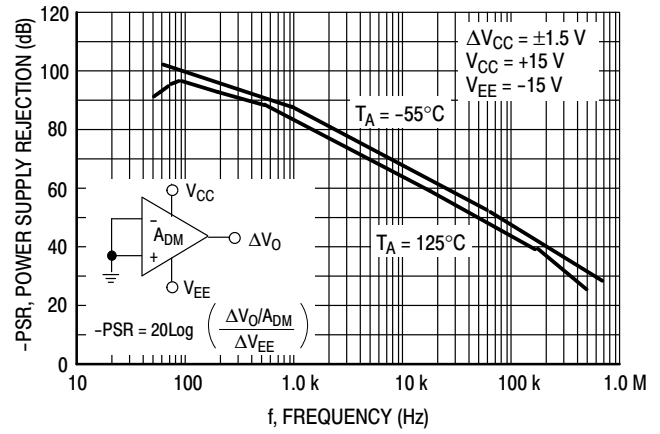


Figure 15. Negative Power Supply Rejection versus Frequency

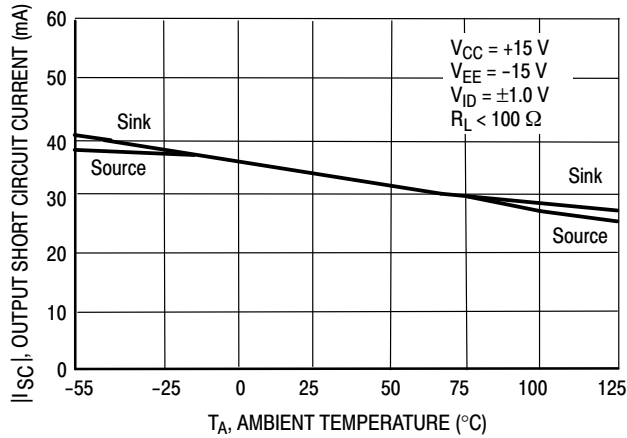


Figure 16. Output Short Circuit Current versus Temperature

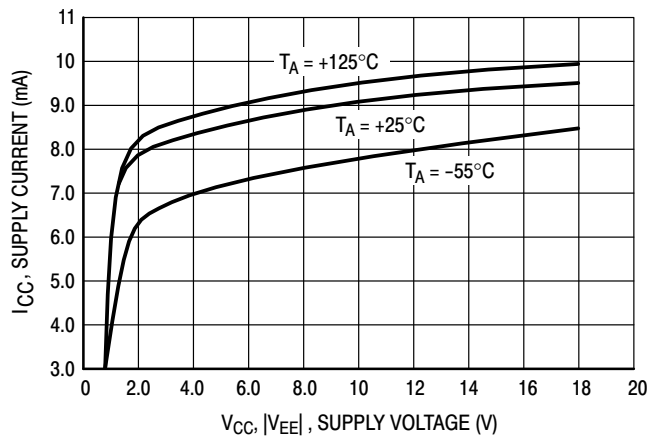


Figure 17. Supply Current versus Supply Voltage

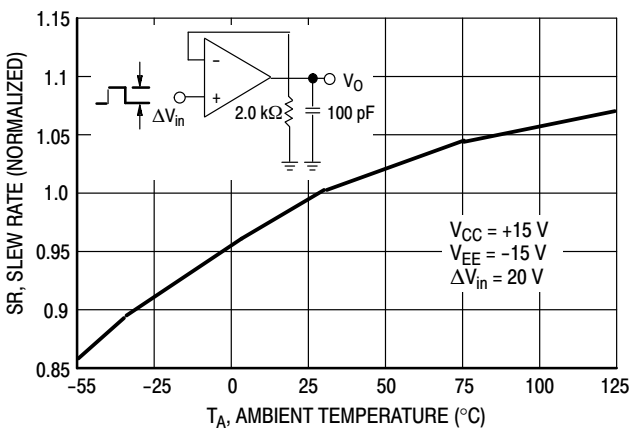


Figure 18. Normalized Slew Rate versus Temperature

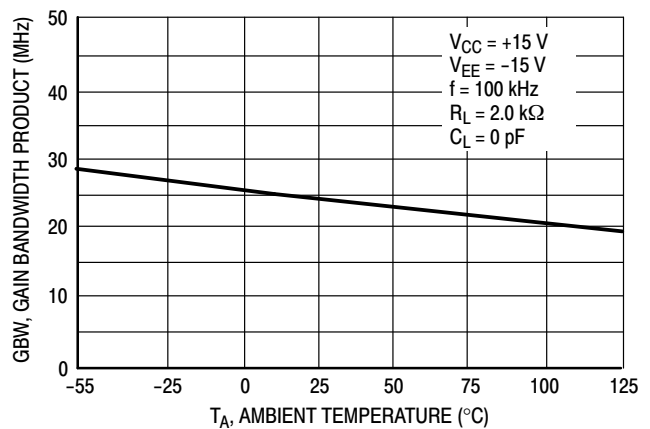


Figure 19. Gain Bandwidth Product versus Temperature

MC33272A, MC33274A, NCV33272A, NCV33274A

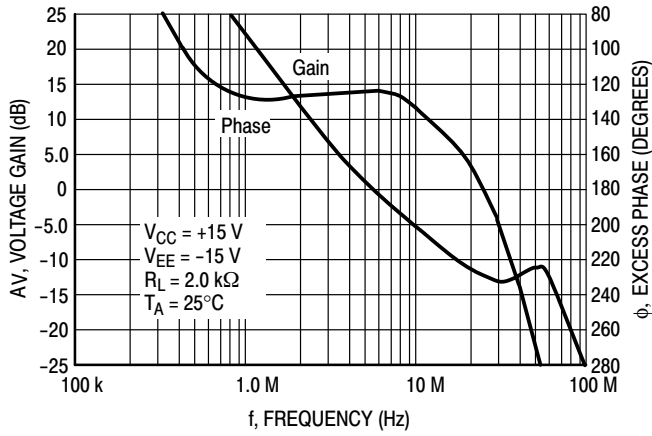


Figure 20. Voltage Gain and Phase versus Frequency

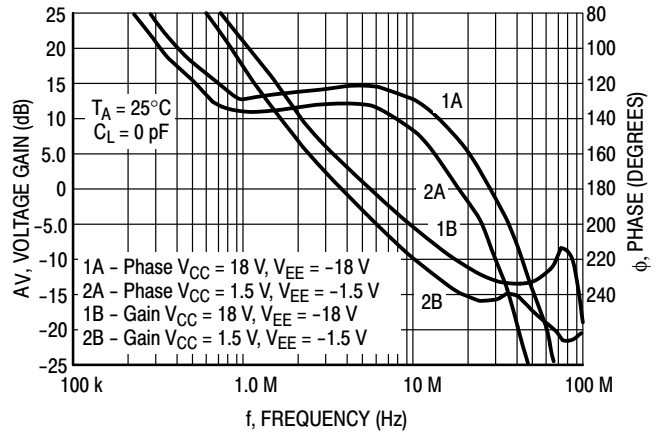


Figure 21. Gain and Phase versus Frequency

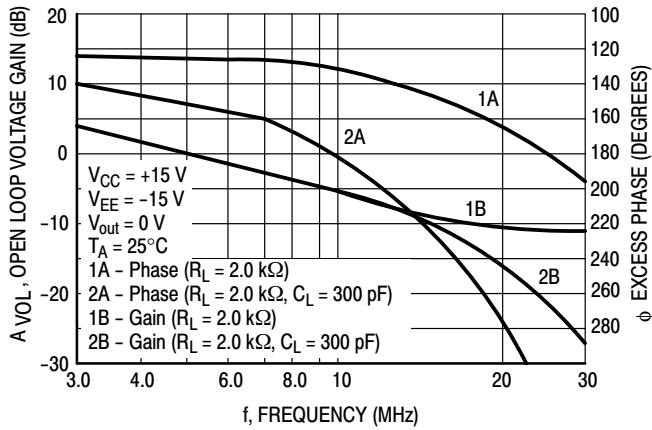


Figure 22. Open Loop Voltage Gain and Phase versus Frequency

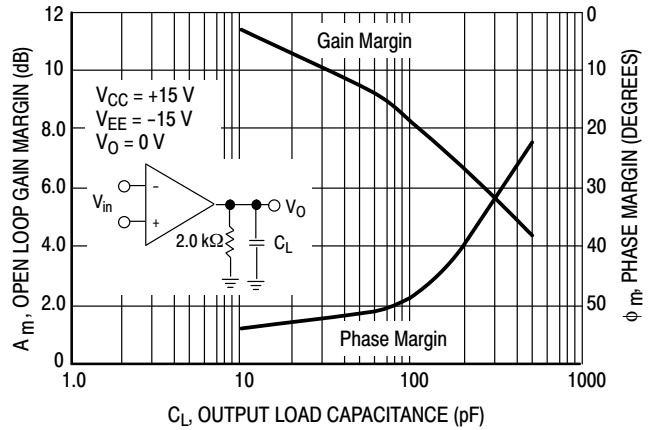


Figure 23. Open Loop Gain Margin and Phase Margin versus Output Load Capacitance

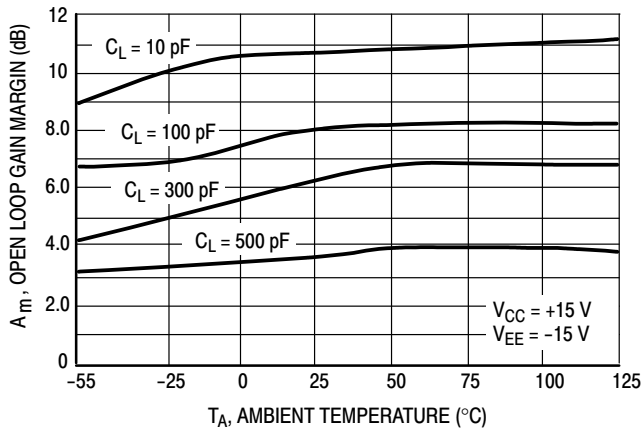


Figure 24. Open Loop Gain Margin versus Temperature

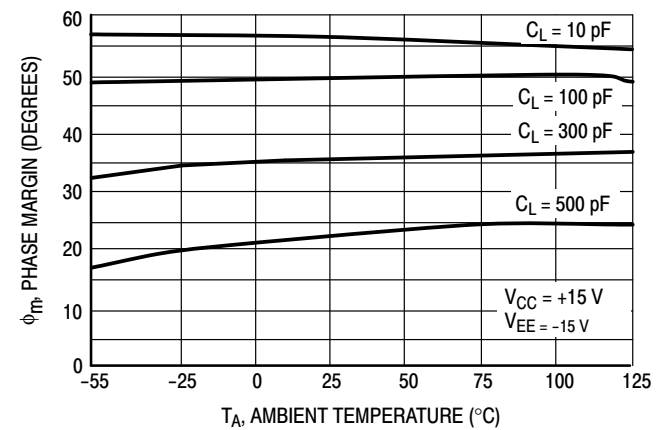


Figure 25. Phase Margin versus Temperature

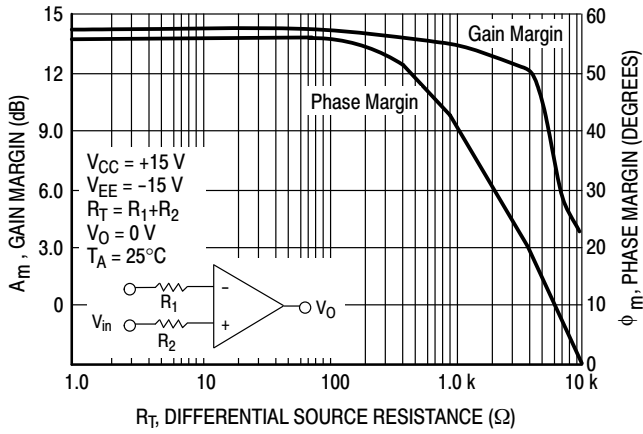


Figure 26. Phase Margin and Gain Margin versus Differential Source Resistance

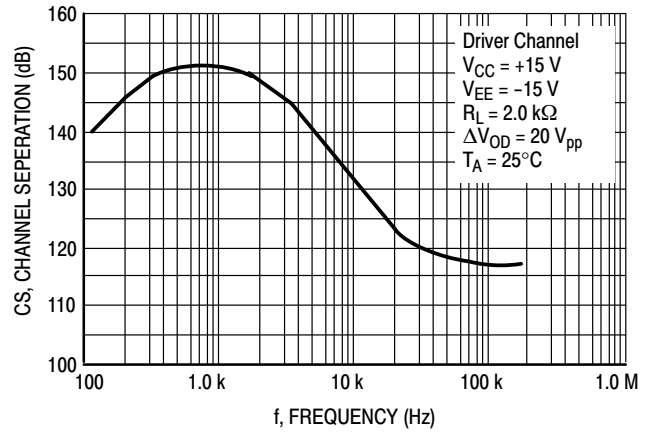


Figure 27. Channel Separation versus Frequency

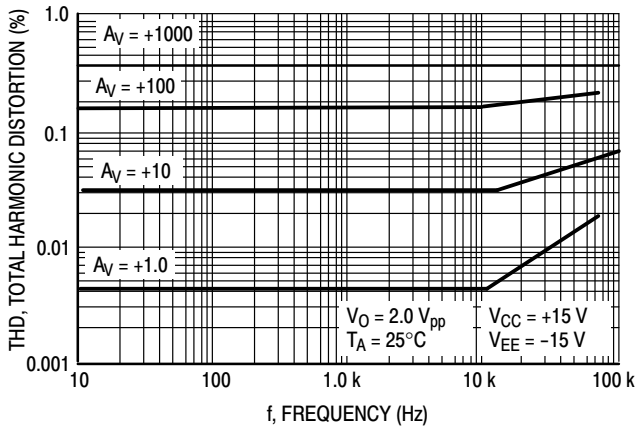


Figure 28. Total Harmonic Distortion versus Frequency

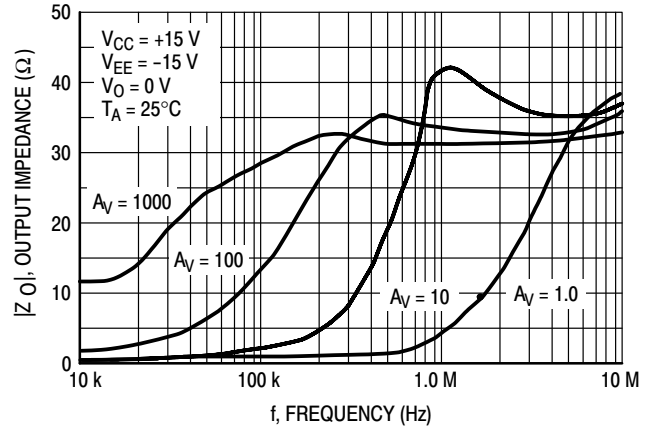


Figure 29. Output Impedance versus Frequency

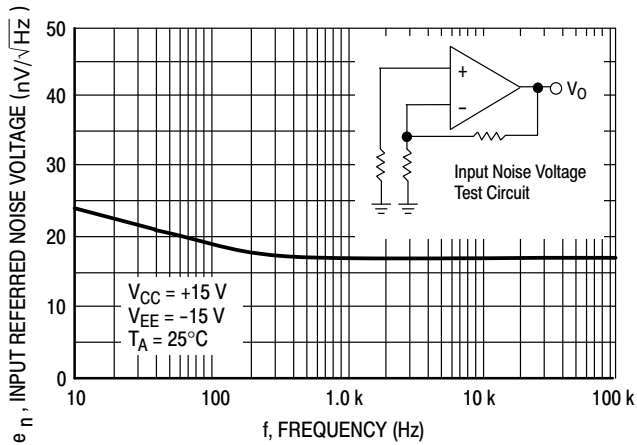


Figure 30. Input Referred Noise Voltage versus Frequency

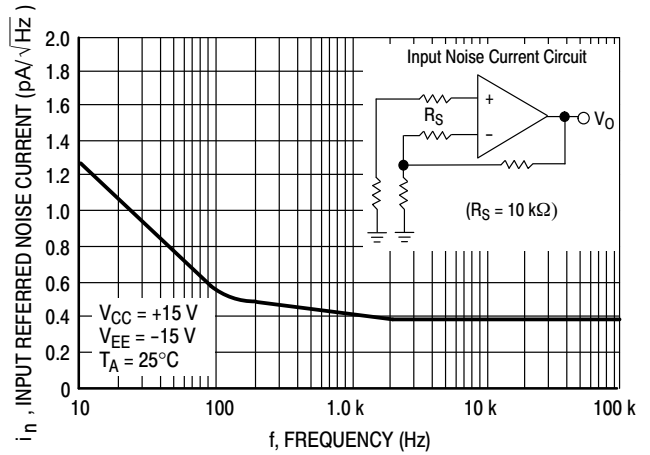


Figure 31. Input Referred Noise Current versus Frequency

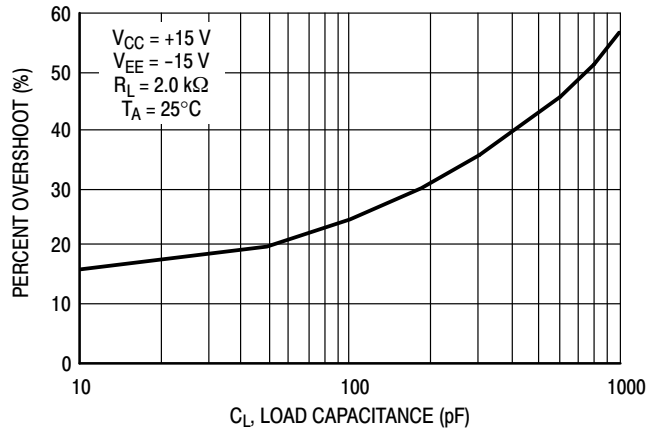


Figure 32. Percent Overshoot versus Load Capacitance

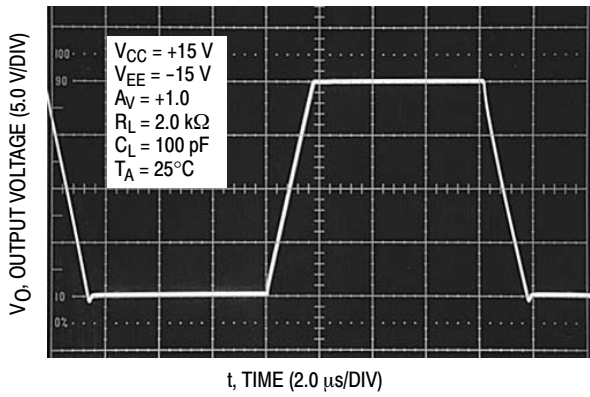


Figure 33. Non-inverting Amplifier Slew Rate for the MC33274

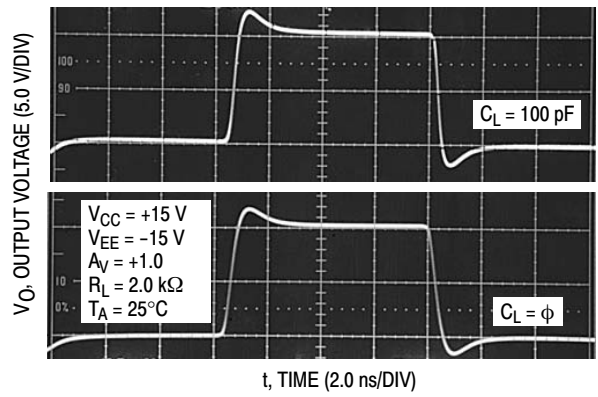


Figure 34. Non-inverting Amplifier Overshoot for the MC33274

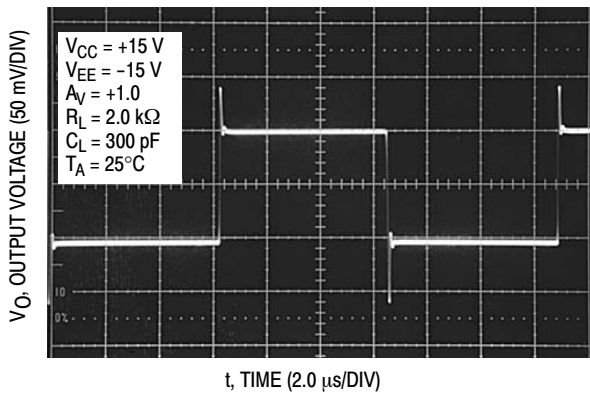


Figure 35. Small Signal Transient Response for MC33274

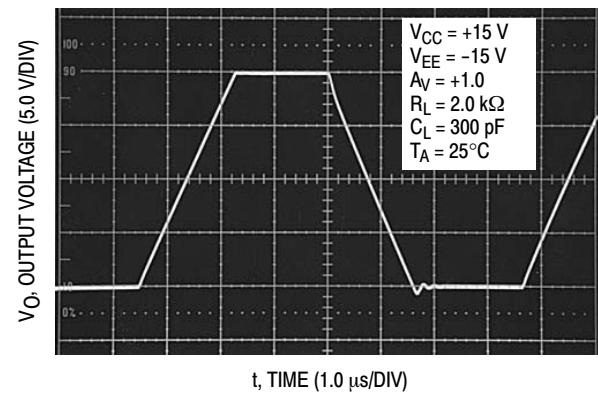


Figure 36. Large Signal Transient Response for MC33274

## MC33272A, MC33274A, NCV33272A, NCV33274A

### ORDERING INFORMATION

Device	Package	Shipping†
MC33272AD	SOIC-8	98 Units / Rail
MC33272ADG	SOIC-8 (Pb-Free)	
MC33272ADR2	SOIC-8	2500 / Tape & Reel
MC33272ADR2G	SOIC-8 (Pb-Free)	
MC33272AP	PDIP-8	50 Units / Rail
MC33272APG	PDIP-8 (Pb-Free)	
NCV33272ADR2*	SOIC-8	2500 / Tape & Reel
NCV33272ADR2G*	SOIC-8 (Pb-Free)	
MC33274AD	SOIC-14	55 Units / Rail
MC33274ADG	SOIC-14 (Pb-Free)	
MC33274ADR2	SOIC-14	2500 / Tape & Reel
MC33274ADR2G	SOIC-14 (Pb-Free)	
MC33274ADTBR2G	TSSOP-14 (Pb-Free)	
MC33274AP	PDIP-14	25 Units / Rail
MC33274APG	PDIP-14 (Pb-Free)	
NCV33274AD*	SOIC-14	55 Units / Rail
NCV33274ADG*	SOIC-14 (Pb-Free)	
NCV33274ADR2*	SOIC-14	2500 / Tape & Reel
NCV33274ADR2G*	SOIC-14 (Pb-Free)	
NCV33274ADTBR2G*	TSSOP-14 (Pb-Free)	

†For information on tape and reel specifications, including part orientation and tape sizes, please refer to our Tape and Reel Packaging Specifications Brochure, BRD8011/D.

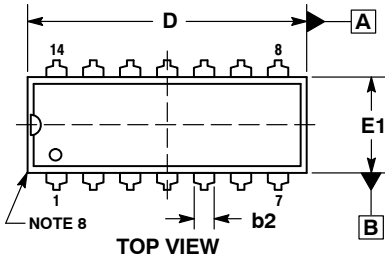
\*NCV Prefix for Automotive and Other Applications Requiring Unique Site and Control Change Requirements; AEC-Q100 Qualified and PPAP Capable.

# MECHANICAL CASE OUTLINE PACKAGE DIMENSIONS

ON Semiconductor®

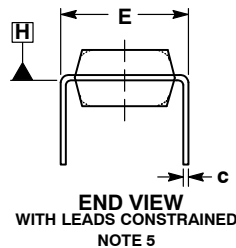


SCALE 1:1



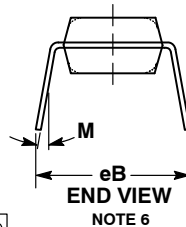
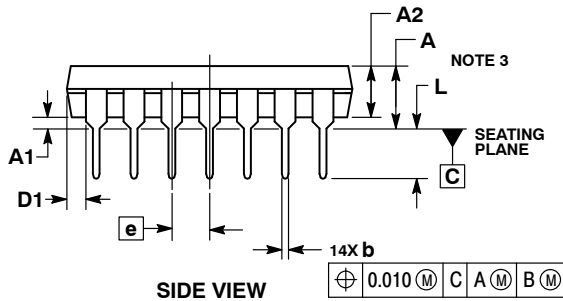
PDIP-14  
CASE 646-06  
ISSUE S

DATE 22 APR 2015



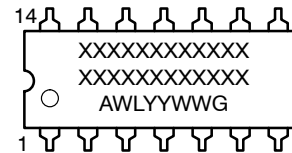
NOTES:

1. DIMENSIONING AND TOLERANCING PER ASME Y14.5M, 1994.
2. CONTROLLING DIMENSION: INCHES.
3. DIMENSIONS A, A1 AND L ARE MEASURED WITH THE PACKAGE SEATED IN JEDEC SEATING PLANE GAUGE GS-3.
4. DIMENSIONS D, D1 AND E1 DO NOT INCLUDE MOLD FLASH OR PROTRUSIONS. MOLD FLASH OR PROTRUSIONS ARE NOT TO EXCEED 0.10 INCH.
5. DIMENSION E IS MEASURED AT A POINT 0.015 BELOW DATUM PLANE H WITH THE LEADS CONSTRAINED PERPENDICULAR TO DATUM C.
6. DIMENSION eB IS MEASURED AT THE LEAD TIPS WITH THE LEADS UNCONSTRAINED.
7. DATUM PLANE H IS COINCIDENT WITH THE BOTTOM OF THE LEADS, WHERE THE LEADS EXIT THE BODY.
8. PACKAGE CONTOUR IS OPTIONAL (ROUNDED OR SQUARE CORNERS).



DIM	INCHES		MILLIMETERS	
	MIN	MAX	MIN	MAX
A	----	0.210	----	5.33
A1	0.015	----	0.38	----
A2	0.115	0.195	2.92	4.95
b	0.014	0.022	0.35	0.56
b2	0.060 TYP		1.52 TYP	
C	0.008	0.014	0.20	0.36
D	0.735	0.775	18.67	19.69
D1	0.005	----	0.13	----
E	0.300	0.325	7.62	8.26
E1	0.240	0.280	6.10	7.11
e	0.100 BSC		2.54 BSC	
eB	----	0.430	----	10.92
L	0.115	0.150	2.92	3.81
M	----	10°	----	10°

GENERIC  
MARKING DIAGRAM\*



- XXXXX = Specific Device Code
- A = Assembly Location
- WL = Wafer Lot
- YY = Year
- WW = Work Week
- G = Pb-Free Package

\*This information is generic. Please refer to device data sheet for actual part marking. Pb-Free indicator, "G" or microdot "▪", may or may not be present.

STYLES ON PAGE 2

DOCUMENT NUMBER:	98ASB42428B	Electronic versions are uncontrolled except when accessed directly from the Document Repository. Printed versions are uncontrolled except when stamped "CONTROLLED COPY" in red.
DESCRIPTION:	PDIP-14	PAGE 1 OF 2

ON Semiconductor and ON are trademarks of Semiconductor Components Industries, LLC dba ON Semiconductor or its subsidiaries in the United States and/or other countries. ON Semiconductor reserves the right to make changes without further notice to any products herein. ON Semiconductor makes no warranty, representation or guarantee regarding the suitability of its products for any particular purpose, nor does ON Semiconductor assume any liability arising out of the application or use of any product or circuit, and specifically disclaims any and all liability, including without limitation special, consequential or incidental damages. ON Semiconductor does not convey any license under its patent rights nor the rights of others.

**PDIP-14**  
**CASE 646-06**  
**ISSUE S**

DATE 22 APR 2015

STYLE 1:  
 PIN 1. COLLECTOR  
 2. BASE  
 3. EMITTER  
 4. NO  
 CONNECTION  
 5. EMITTER  
 6. BASE  
 7. COLLECTOR  
 8. COLLECTOR  
 9. BASE  
 10. EMITTER  
 11. NO  
 CONNECTION  
 12. EMITTER  
 13. BASE  
 14. COLLECTOR

STYLE 2:  
 CANCELLED

STYLE 3:  
 CANCELLED

STYLE 4:  
 PIN 1. DRAIN  
 2. SOURCE  
 3. GATE  
 4. NO  
 CONNECTION  
 5. GATE  
 6. SOURCE  
 7. DRAIN  
 8. DRAIN  
 9. SOURCE  
 10. GATE  
 11. NO  
 CONNECTION  
 12. GATE  
 13. SOURCE  
 14. DRAIN

STYLE 5:  
 PIN 1. GATE  
 2. DRAIN  
 3. SOURCE  
 4. NO CONNECTION  
 5. SOURCE  
 6. DRAIN  
 7. GATE  
 8. GATE  
 9. DRAIN  
 10. SOURCE  
 11. NO CONNECTION  
 12. SOURCE  
 13. DRAIN  
 14. GATE

STYLE 6:  
 PIN 1. COMMON CATHODE  
 2. ANODE/CATHODE  
 3. ANODE/CATHODE  
 4. NO CONNECTION  
 5. ANODE/CATHODE  
 6. NO CONNECTION  
 7. ANODE/CATHODE  
 8. ANODE/CATHODE  
 9. ANODE/CATHODE  
 10. NO CONNECTION  
 11. ANODE/CATHODE  
 12. ANODE/CATHODE  
 13. NO CONNECTION  
 14. COMMON ANODE

STYLE 7:  
 PIN 1. NO CONNECTION  
 2. ANODE  
 3. ANODE  
 4. NO CONNECTION  
 5. ANODE  
 6. NO CONNECTION  
 7. ANODE  
 8. ANODE  
 9. ANODE  
 10. NO CONNECTION  
 11. ANODE  
 12. ANODE  
 13. NO CONNECTION  
 14. COMMON  
 CATHODE

STYLE 8:  
 PIN 1. NO CONNECTION  
 2. CATHODE  
 3. CATHODE  
 4. NO CONNECTION  
 5. CATHODE  
 6. NO CONNECTION  
 7. CATHODE  
 8. CATHODE  
 9. CATHODE  
 10. NO CONNECTION  
 11. CATHODE  
 12. CATHODE  
 13. NO CONNECTION  
 14. COMMON ANODE

STYLE 9:  
 PIN 1. COMMON CATHODE  
 2. ANODE/CATHODE  
 3. ANODE/CATHODE  
 4. NO CONNECTION  
 5. ANODE/CATHODE  
 6. ANODE/CATHODE  
 7. COMMON ANODE  
 8. COMMON ANODE  
 9. ANODE/CATHODE  
 10. ANODE/CATHODE  
 11. NO CONNECTION  
 12. ANODE/CATHODE  
 13. ANODE/CATHODE  
 14. COMMON CATHODE

STYLE 10:  
 PIN 1. COMMON  
 CATHODE  
 2. ANODE/CATHODE  
 3. ANODE/CATHODE  
 4. ANODE/CATHODE  
 5. ANODE/CATHODE  
 6. NO CONNECTION  
 7. COMMON ANODE  
 8. COMMON  
 CATHODE  
 9. ANODE/CATHODE  
 10. ANODE/CATHODE  
 11. ANODE/CATHODE  
 12. ANODE/CATHODE  
 13. NO CONNECTION  
 14. COMMON ANODE

STYLE 11:  
 PIN 1. CATHODE  
 2. CATHODE  
 3. CATHODE  
 4. CATHODE  
 5. CATHODE  
 6. CATHODE  
 7. CATHODE  
 8. ANODE  
 9. ANODE  
 10. ANODE  
 11. ANODE  
 12. ANODE  
 13. ANODE  
 14. ANODE

STYLE 12:  
 PIN 1. COMMON CATHODE  
 2. COMMON ANODE  
 3. ANODE/CATHODE  
 4. ANODE/CATHODE  
 5. ANODE/CATHODE  
 6. COMMON ANODE  
 7. COMMON CATHODE  
 8. ANODE/CATHODE  
 9. ANODE/CATHODE  
 10. ANODE/CATHODE  
 11. ANODE/CATHODE  
 12. ANODE/CATHODE  
 13. ANODE/CATHODE  
 14. ANODE/CATHODE

<b>DOCUMENT NUMBER:</b>	<b>98ASB42428B</b>	Electronic versions are uncontrolled except when accessed directly from the Document Repository. Printed versions are uncontrolled except when stamped "CONTROLLED COPY" in red.
<b>DESCRIPTION:</b>	<b>PDIP-14</b>	<b>PAGE 2 OF 2</b>

ON Semiconductor and  are trademarks of Semiconductor Components Industries, LLC dba ON Semiconductor or its subsidiaries in the United States and/or other countries. ON Semiconductor reserves the right to make changes without further notice to any products herein. ON Semiconductor makes no warranty, representation or guarantee regarding the suitability of its products for any particular purpose, nor does ON Semiconductor assume any liability arising out of the application or use of any product or circuit, and specifically disclaims any and all liability, including without limitation special, consequential or incidental damages. ON Semiconductor does not convey any license under its patent rights nor the rights of others.

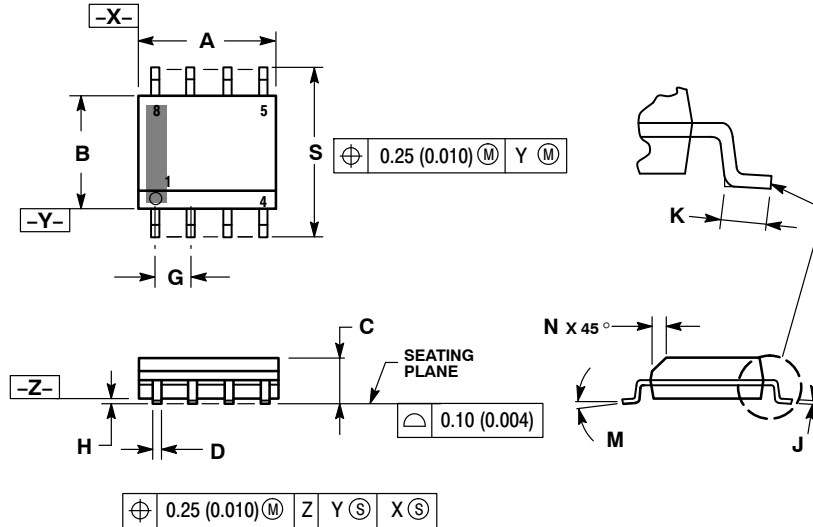
# MECHANICAL CASE OUTLINE PACKAGE DIMENSIONS



SCALE 1:1

SOIC-8 NB  
CASE 751-07  
ISSUE AK

DATE 16 FEB 2011

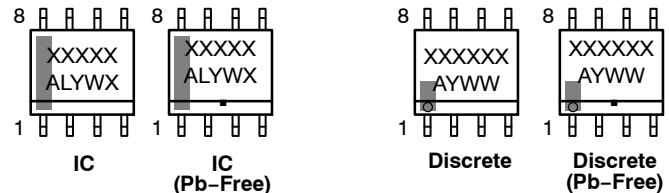
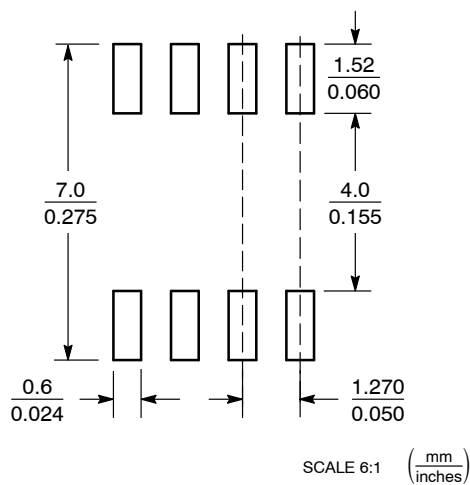


- NOTES:
1. DIMENSIONING AND TOLERANCING PER ANSI Y14.5M, 1982.
  2. CONTROLLING DIMENSION: MILLIMETER.
  3. DIMENSION A AND B DO NOT INCLUDE MOLD PROTRUSION.
  4. MAXIMUM MOLD PROTRUSION 0.15 (0.006) PER SIDE.
  5. DIMENSION D DOES NOT INCLUDE DAMBAR PROTRUSION. ALLOWABLE DAMBAR PROTRUSION SHALL BE 0.127 (0.005) TOTAL IN EXCESS OF THE D DIMENSION AT MAXIMUM MATERIAL CONDITION.
  6. 751-01 THRU 751-06 ARE OBSOLETE. NEW STANDARD IS 751-07.

DIM	MILLIMETERS		INCHES	
	MIN	MAX	MIN	MAX
A	4.80	5.00	0.189	0.197
B	3.80	4.00	0.150	0.157
C	1.35	1.75	0.053	0.069
D	0.33	0.51	0.013	0.020
G	1.27 BSC		0.050 BSC	
H	0.10	0.25	0.004	0.010
J	0.19	0.25	0.007	0.010
K	0.40	1.27	0.016	0.050
M	0°	8°	0°	8°
N	0.25	0.50	0.010	0.020
S	5.80	6.20	0.228	0.244

## GENERIC MARKING DIAGRAM\*

### SOLDERING FOOTPRINT\*



XXXXX = Specific Device Code  
A = Assembly Location  
L = Wafer Lot  
Y = Year  
W = Work Week  
▪ = Pb-Free Package

XXXXXX = Specific Device Code  
A = Assembly Location  
Y = Year  
WW = Work Week  
▪ = Pb-Free Package

\*This information is generic. Please refer to device data sheet for actual part marking. Pb-Free indicator, "G" or microdot "▪", may or may not be present. Some products may not follow the Generic Marking.

\*For additional information on our Pb-Free strategy and soldering details, please download the ON Semiconductor Soldering and Mounting Techniques Reference Manual, SOLDERRM/D.

## STYLES ON PAGE 2

DOCUMENT NUMBER:	98ASB42564B	Electronic versions are uncontrolled except when accessed directly from the Document Repository. Printed versions are uncontrolled except when stamped "CONTROLLED COPY" in red.
DESCRIPTION:	SOIC-8 NB	PAGE 1 OF 2

onsemi and ONsemi are trademarks of Semiconductor Components Industries, LLC dba onsemi or its subsidiaries in the United States and/or other countries. onsemi reserves the right to make changes without further notice to any products herein. onsemi makes no warranty, representation or guarantee regarding the suitability of its products for any particular purpose, nor does onsemi assume any liability arising out of the application or use of any product or circuit, and specifically disclaims any and all liability, including without limitation special, consequential or incidental damages. onsemi does not convey any license under its patent rights nor the rights of others.

**SOIC-8 NB**  
**CASE 751-07**  
**ISSUE AK**

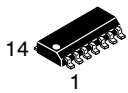
DATE 16 FEB 2011

- |   |  |  |  |
|---|--|--|--|
| <p>STYLE 1:<br/>         PIN 1. EMITTER<br/>         2. COLLECTOR<br/>         3. COLLECTOR<br/>         4. EMITTER<br/>         5. EMITTER<br/>         6. BASE<br/>         7. BASE<br/>         8. EMITTER</p>   | <p>STYLE 2:<br/>         PIN 1. COLLECTOR, DIE, #1<br/>         2. COLLECTOR, #1<br/>         3. COLLECTOR, #2<br/>         4. COLLECTOR, #2<br/>         5. BASE, #2<br/>         6. EMITTER, #2<br/>         7. BASE, #1<br/>         8. EMITTER, #1</p>               | <p>STYLE 3:<br/>         PIN 1. DRAIN, DIE #1<br/>         2. DRAIN, #1<br/>         3. DRAIN, #2<br/>         4. DRAIN, #2<br/>         5. GATE, #2<br/>         6. SOURCE, #2<br/>         7. GATE, #1<br/>         8. SOURCE, #1</p>                            | <p>STYLE 4:<br/>         PIN 1. ANODE<br/>         2. ANODE<br/>         3. ANODE<br/>         4. ANODE<br/>         5. ANODE<br/>         6. ANODE<br/>         7. ANODE<br/>         8. COMMON CATHODE</p>   |
| <p>STYLE 5:<br/>         PIN 1. DRAIN<br/>         2. DRAIN<br/>         3. DRAIN<br/>         4. DRAIN<br/>         5. GATE<br/>         6. GATE<br/>         7. SOURCE<br/>         8. SOURCE</p>   | <p>STYLE 6:<br/>         PIN 1. SOURCE<br/>         2. DRAIN<br/>         3. DRAIN<br/>         4. SOURCE<br/>         5. SOURCE<br/>         6. GATE<br/>         7. GATE<br/>         8. SOURCE</p>  | <p>STYLE 7:<br/>         PIN 1. INPUT<br/>         2. EXTERNAL BYPASS<br/>         3. THIRD STAGE SOURCE<br/>         4. GROUND<br/>         5. DRAIN<br/>         6. GATE 3<br/>         7. SECOND STAGE Vd<br/>         8. FIRST STAGE Vd</p>                    | <p>STYLE 8:<br/>         PIN 1. COLLECTOR, DIE #1<br/>         2. BASE, #1<br/>         3. BASE, #2<br/>         4. COLLECTOR, #2<br/>         5. COLLECTOR, #2<br/>         6. EMITTER, #2<br/>         7. EMITTER, #1<br/>         8. COLLECTOR, #1</p>                              |
| <p>STYLE 9:<br/>         PIN 1. EMITTER, COMMON<br/>         2. COLLECTOR, DIE #1<br/>         3. COLLECTOR, DIE #2<br/>         4. EMITTER, COMMON<br/>         5. EMITTER, COMMON<br/>         6. BASE, DIE #2<br/>         7. BASE, DIE #1<br/>         8. EMITTER, COMMON</p> | <p>STYLE 10:<br/>         PIN 1. GROUND<br/>         2. BIAS 1<br/>         3. OUTPUT<br/>         4. GROUND<br/>         5. GROUND<br/>         6. BIAS 2<br/>         7. INPUT<br/>         8. GROUND</p>  | <p>STYLE 11:<br/>         PIN 1. SOURCE 1<br/>         2. GATE 1<br/>         3. SOURCE 2<br/>         4. GATE 2<br/>         5. DRAIN 2<br/>         6. DRAIN 2<br/>         7. DRAIN 1<br/>         8. DRAIN 1</p>   | <p>STYLE 12:<br/>         PIN 1. SOURCE<br/>         2. SOURCE<br/>         3. SOURCE<br/>         4. GATE<br/>         5. DRAIN<br/>         6. DRAIN<br/>         7. DRAIN<br/>         8. DRAIN</p>   |
| <p>STYLE 13:<br/>         PIN 1. N.C.<br/>         2. SOURCE<br/>         3. SOURCE<br/>         4. GATE<br/>         5. DRAIN<br/>         6. DRAIN<br/>         7. DRAIN<br/>         8. DRAIN</p>  | <p>STYLE 14:<br/>         PIN 1. N-SOURCE<br/>         2. N-GATE<br/>         3. P-SOURCE<br/>         4. P-GATE<br/>         5. P-DRAIN<br/>         6. P-DRAIN<br/>         7. N-DRAIN<br/>         8. N-DRAIN</p>   | <p>STYLE 15:<br/>         PIN 1. ANODE 1<br/>         2. ANODE 1<br/>         3. ANODE 1<br/>         4. ANODE 1<br/>         5. CATHODE, COMMON<br/>         6. CATHODE, COMMON<br/>         7. CATHODE, COMMON<br/>         8. CATHODE, COMMON</p>               | <p>STYLE 16:<br/>         PIN 1. EMITTER, DIE #1<br/>         2. BASE, DIE #1<br/>         3. EMITTER, DIE #2<br/>         4. BASE, DIE #2<br/>         5. COLLECTOR, DIE #2<br/>         6. COLLECTOR, DIE #2<br/>         7. COLLECTOR, DIE #1<br/>         8. COLLECTOR, DIE #1</p> |
| <p>STYLE 17:<br/>         PIN 1. VCC<br/>         2. V2OUT<br/>         3. V1OUT<br/>         4. TXE<br/>         5. RXE<br/>         6. VEE<br/>         7. GND<br/>         8. ACC</p>  | <p>STYLE 18:<br/>         PIN 1. ANODE<br/>         2. ANODE<br/>         3. SOURCE<br/>         4. GATE<br/>         5. DRAIN<br/>         6. DRAIN<br/>         7. CATHODE<br/>         8. CATHODE</p>   | <p>STYLE 19:<br/>         PIN 1. SOURCE 1<br/>         2. GATE 1<br/>         3. SOURCE 2<br/>         4. GATE 2<br/>         5. DRAIN 2<br/>         6. MIRROR 2<br/>         7. DRAIN 1<br/>         8. MIRROR 1</p>   | <p>STYLE 20:<br/>         PIN 1. SOURCE (N)<br/>         2. GATE (N)<br/>         3. SOURCE (P)<br/>         4. GATE (P)<br/>         5. DRAIN<br/>         6. DRAIN<br/>         7. DRAIN<br/>         8. DRAIN</p>   |
| <p>STYLE 21:<br/>         PIN 1. CATHODE 1<br/>         2. CATHODE 2<br/>         3. CATHODE 3<br/>         4. CATHODE 4<br/>         5. CATHODE 5<br/>         6. COMMON ANODE<br/>         7. COMMON ANODE<br/>         8. CATHODE 6</p>  | <p>STYLE 22:<br/>         PIN 1. I/O LINE 1<br/>         2. COMMON CATHODE/VCC<br/>         3. COMMON CATHODE/VCC<br/>         4. I/O LINE 3<br/>         5. COMMON ANODE/GND<br/>         6. I/O LINE 4<br/>         7. I/O LINE 5<br/>         8. COMMON ANODE/GND</p> | <p>STYLE 23:<br/>         PIN 1. LINE 1 IN<br/>         2. COMMON ANODE/GND<br/>         3. COMMON ANODE/GND<br/>         4. LINE 2 IN<br/>         5. LINE 2 OUT<br/>         6. COMMON ANODE/GND<br/>         7. COMMON ANODE/GND<br/>         8. LINE 1 OUT</p> | <p>STYLE 24:<br/>         PIN 1. BASE<br/>         2. EMITTER<br/>         3. COLLECTOR/ANODE<br/>         4. COLLECTOR/ANODE<br/>         5. CATHODE<br/>         6. CATHODE<br/>         7. COLLECTOR/ANODE<br/>         8. COLLECTOR/ANODE</p>                                      |
| <p>STYLE 25:<br/>         PIN 1. VIN<br/>         2. N/C<br/>         3. REXT<br/>         4. GND<br/>         5. IOUT<br/>         6. IOUT<br/>         7. IOUT<br/>         8. IOUT</p>   | <p>STYLE 26:<br/>         PIN 1. GND<br/>         2. dv/dt<br/>         3. ENABLE<br/>         4. ILIMIT<br/>         5. SOURCE<br/>         6. SOURCE<br/>         7. SOURCE<br/>         8. VCC</p>  | <p>STYLE 27:<br/>         PIN 1. ILIMIT<br/>         2. OVLO<br/>         3. UVLO<br/>         4. INPUT+<br/>         5. SOURCE<br/>         6. SOURCE<br/>         7. SOURCE<br/>         8. DRAIN</p>  | <p>STYLE 28:<br/>         PIN 1. SW_TO_GND<br/>         2. DASIC_OFF<br/>         3. DASIC_SW_DET<br/>         4. GND<br/>         5. V_MON<br/>         6. VBULK<br/>         7. VBULK<br/>         8. VIN</p>  |
| <p>STYLE 29:<br/>         PIN 1. BASE, DIE #1<br/>         2. EMITTER, #1<br/>         3. BASE, #2<br/>         4. EMITTER, #2<br/>         5. COLLECTOR, #2<br/>         6. COLLECTOR, #2<br/>         7. COLLECTOR, #1<br/>         8. COLLECTOR, #1</p>                        | <p>STYLE 30:<br/>         PIN 1. DRAIN 1<br/>         2. DRAIN 1<br/>         3. GATE 2<br/>         4. SOURCE 2<br/>         5. SOURCE 1/DRAIN 2<br/>         6. SOURCE 1/DRAIN 2<br/>         7. SOURCE 1/DRAIN 2<br/>         8. GATE 1</p>                           |  |  |

<b>DOCUMENT NUMBER:</b>	<b>98ASB42564B</b>	Electronic versions are uncontrolled except when accessed directly from the Document Repository. Printed versions are uncontrolled except when stamped "CONTROLLED COPY" in red.
<b>DESCRIPTION:</b>	<b>SOIC-8 NB</b>	<b>PAGE 2 OF 2</b>

**onsemi** and **ONSEMI** are trademarks of Semiconductor Components Industries, LLC dba **onsemi** or its subsidiaries in the United States and/or other countries. **onsemi** reserves the right to make changes without further notice to any products herein. **onsemi** makes no warranty, representation or guarantee regarding the suitability of its products for any particular purpose, nor does **onsemi** assume any liability arising out of the application or use of any product or circuit, and specifically disclaims any and all liability, including without limitation special, consequential or incidental damages. **onsemi** does not convey any license under its patent rights nor the rights of others.

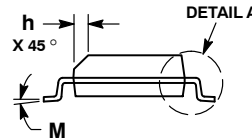
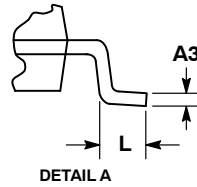
# MECHANICAL CASE OUTLINE PACKAGE DIMENSIONS



SCALE 1:1

SOIC-14 NB  
CASE 751A-03  
ISSUE L

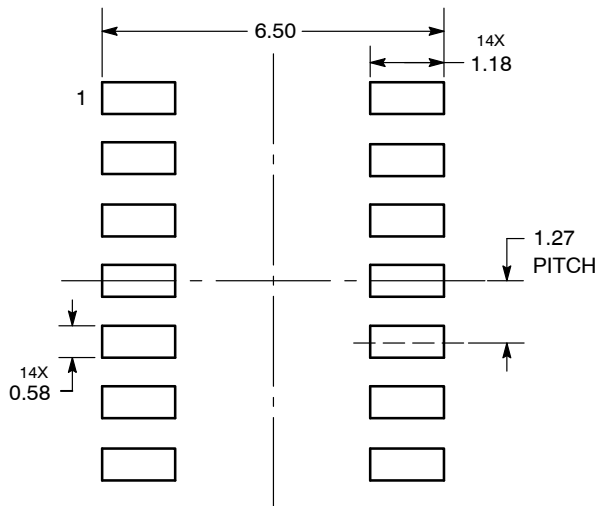
DATE 03 FEB 2016



- NOTES:
1. DIMENSIONING AND TOLERANCING PER ASME Y14.5M, 1994.
  2. CONTROLLING DIMENSION: MILLIMETERS.
  3. DIMENSION b DOES NOT INCLUDE DAMBAR PROTRUSION. ALLOWABLE PROTRUSION SHALL BE 0.13 TOTAL IN EXCESS OF AT MAXIMUM MATERIAL CONDITION.
  4. DIMENSIONS D AND E DO NOT INCLUDE MOLD PROTRUSIONS.
  5. MAXIMUM MOLD PROTRUSION 0.15 PER SIDE.

DIM	MILLIMETERS		INCHES	
	MIN	MAX	MIN	MAX
A	1.35	1.75	0.054	0.068
A1	0.10	0.25	0.004	0.010
A3	0.19	0.25	0.008	0.010
b	0.35	0.49	0.014	0.019
D	8.55	8.75	0.337	0.344
E	3.80	4.00	0.150	0.157
e	1.27 BSC		0.050 BSC	
H	5.80	6.20	0.228	0.244
h	0.25	0.50	0.010	0.019
L	0.40	1.25	0.016	0.049
M	0°	7°	0°	7°

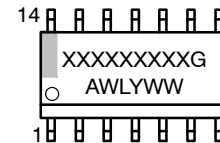
### SOLDERING FOOTPRINT\*



DIMENSIONS: MILLIMETERS

\*For additional information on our Pb-Free strategy and soldering details, please download the ON Semiconductor Soldering and Mounting Techniques Reference Manual, SOLDERRM/D.

### GENERIC MARKING DIAGRAM\*



- XXXXXX = Specific Device Code
- A = Assembly Location
- WL = Wafer Lot
- Y = Year
- WW = Work Week
- G = Pb-Free Package

\*This information is generic. Please refer to device data sheet for actual part marking. Pb-Free indicator, "G" or microdot "▪", may or may not be present. Some products may not follow the Generic Marking.

STYLES ON PAGE 2

DOCUMENT NUMBER:	98ASB42565B	Electronic versions are uncontrolled except when accessed directly from the Document Repository. Printed versions are uncontrolled except when stamped "CONTROLLED COPY" in red.
DESCRIPTION:	SOIC-14 NB	PAGE 1 OF 2

onsemi and ONSEMI are trademarks of Semiconductor Components Industries, LLC dba onsemi or its subsidiaries in the United States and/or other countries. onsemi reserves the right to make changes without further notice to any products herein. onsemi makes no warranty, representation or guarantee regarding the suitability of its products for any particular purpose, nor does onsemi assume any liability arising out of the application or use of any product or circuit, and specifically disclaims any and all liability, including without limitation special, consequential or incidental damages. onsemi does not convey any license under its patent rights nor the rights of others.

**SOIC-14**  
**CASE 751A-03**  
**ISSUE L**

DATE 03 FEB 2016

STYLE 1:  
 PIN 1. COMMON CATHODE  
 2. ANODE/CATHODE  
 3. ANODE/CATHODE  
 4. NO CONNECTION  
 5. ANODE/CATHODE  
 6. NO CONNECTION  
 7. ANODE/CATHODE  
 8. ANODE/CATHODE  
 9. ANODE/CATHODE  
 10. NO CONNECTION  
 11. ANODE/CATHODE  
 12. ANODE/CATHODE  
 13. NO CONNECTION  
 14. COMMON ANODE

STYLE 2:  
 CANCELLED

STYLE 3:  
 PIN 1. NO CONNECTION  
 2. ANODE  
 3. ANODE  
 4. NO CONNECTION  
 5. ANODE  
 6. NO CONNECTION  
 7. ANODE  
 8. ANODE  
 9. ANODE  
 10. NO CONNECTION  
 11. ANODE  
 12. ANODE  
 13. NO CONNECTION  
 14. COMMON CATHODE

STYLE 4:  
 PIN 1. NO CONNECTION  
 2. CATHODE  
 3. CATHODE  
 4. NO CONNECTION  
 5. CATHODE  
 6. NO CONNECTION  
 7. CATHODE  
 8. CATHODE  
 9. CATHODE  
 10. NO CONNECTION  
 11. CATHODE  
 12. CATHODE  
 13. NO CONNECTION  
 14. COMMON ANODE

STYLE 5:  
 PIN 1. COMMON CATHODE  
 2. ANODE/CATHODE  
 3. ANODE/CATHODE  
 4. ANODE/CATHODE  
 5. ANODE/CATHODE  
 6. NO CONNECTION  
 7. COMMON ANODE  
 8. COMMON CATHODE  
 9. ANODE/CATHODE  
 10. ANODE/CATHODE  
 11. ANODE/CATHODE  
 12. ANODE/CATHODE  
 13. NO CONNECTION  
 14. COMMON ANODE

STYLE 6:  
 PIN 1. CATHODE  
 2. CATHODE  
 3. CATHODE  
 4. CATHODE  
 5. CATHODE  
 6. CATHODE  
 7. CATHODE  
 8. ANODE  
 9. ANODE  
 10. ANODE  
 11. ANODE  
 12. ANODE  
 13. ANODE  
 14. ANODE

STYLE 7:  
 PIN 1. ANODE/CATHODE  
 2. COMMON ANODE  
 3. COMMON CATHODE  
 4. ANODE/CATHODE  
 5. ANODE/CATHODE  
 6. ANODE/CATHODE  
 7. ANODE/CATHODE  
 8. ANODE/CATHODE  
 9. ANODE/CATHODE  
 10. ANODE/CATHODE  
 11. COMMON CATHODE  
 12. COMMON ANODE  
 13. ANODE/CATHODE  
 14. ANODE/CATHODE

STYLE 8:  
 PIN 1. COMMON CATHODE  
 2. ANODE/CATHODE  
 3. ANODE/CATHODE  
 4. NO CONNECTION  
 5. ANODE/CATHODE  
 6. ANODE/CATHODE  
 7. COMMON ANODE  
 8. COMMON ANODE  
 9. ANODE/CATHODE  
 10. ANODE/CATHODE  
 11. NO CONNECTION  
 12. ANODE/CATHODE  
 13. ANODE/CATHODE  
 14. COMMON CATHODE

<b>DOCUMENT NUMBER:</b>	<b>98ASB42565B</b>	Electronic versions are uncontrolled except when accessed directly from the Document Repository. Printed versions are uncontrolled except when stamped "CONTROLLED COPY" in red.
<b>DESCRIPTION:</b>	<b>SOIC-14 NB</b>	<b>PAGE 2 OF 2</b>

**onsemi** and **ONSEMI** are trademarks of Semiconductor Components Industries, LLC dba **onsemi** or its subsidiaries in the United States and/or other countries. **onsemi** reserves the right to make changes without further notice to any products herein. **onsemi** makes no warranty, representation or guarantee regarding the suitability of its products for any particular purpose, nor does **onsemi** assume any liability arising out of the application or use of any product or circuit, and specifically disclaims any and all liability, including without limitation special, consequential or incidental damages. **onsemi** does not convey any license under its patent rights nor the rights of others.

**onsemi**, **Onsemi**, and other names, marks, and brands are registered and/or common law trademarks of Semiconductor Components Industries, LLC dba "**onsemi**" or its affiliates and/or subsidiaries in the United States and/or other countries. **onsemi** owns the rights to a number of patents, trademarks, copyrights, trade secrets, and other intellectual property. A listing of **onsemi**'s product/patent coverage may be accessed at [www.onsemi.com/site/pdf/Patent-Marking.pdf](http://www.onsemi.com/site/pdf/Patent-Marking.pdf). **onsemi** reserves the right to make changes at any time to any products or information herein, without notice. The information herein is provided "as-is" and **onsemi** makes no warranty, representation or guarantee regarding the accuracy of the information, product features, availability, functionality, or suitability of its products for any particular purpose, nor does **onsemi** assume any liability arising out of the application or use of any product or circuit, and specifically disclaims any and all liability, including without limitation special, consequential or incidental damages. Buyer is responsible for its products and applications using **onsemi** products, including compliance with all laws, regulations and safety requirements or standards, regardless of any support or applications information provided by **onsemi**. "Typical" parameters which may be provided in **onsemi** data sheets and/or specifications can and do vary in different applications and actual performance may vary over time. All operating parameters, including "Typicals" must be validated for each customer application by customer's technical experts. **onsemi** does not convey any license under any of its intellectual property rights nor the rights of others. **onsemi** products are not designed, intended, or authorized for use as a critical component in life support systems or any FDA Class 3 medical devices or medical devices with a same or similar classification in a foreign jurisdiction or any devices intended for implantation in the human body. Should Buyer purchase or use **onsemi** products for any such unintended or unauthorized application, Buyer shall indemnify and hold **onsemi** and its officers, employees, subsidiaries, affiliates, and distributors harmless against all claims, costs, damages, and expenses, and reasonable attorney fees arising out of, directly or indirectly, any claim of personal injury or death associated with such unintended or unauthorized use, even if such claim alleges that **onsemi** was negligent regarding the design or manufacture of the part. **onsemi** is an Equal Opportunity/Affirmative Action Employer. This literature is subject to all applicable copyright laws and is not for resale in any manner.

## ADDITIONAL INFORMATION

### TECHNICAL PUBLICATIONS:

Technical Library: [www.onsemi.com/design/resources/technical-documentation](http://www.onsemi.com/design/resources/technical-documentation)  
onsemi Website: [www.onsemi.com](http://www.onsemi.com)

### ONLINE SUPPORT: [www.onsemi.com/support](http://www.onsemi.com/support)

For additional information, please contact your local Sales Representative at [www.onsemi.com/support/sales](http://www.onsemi.com/support/sales)

## Looking for pricing, stock, or lifecycle information?

Click below to explore more details on WIN SOURCE:

 [View NCV33274ADG](#) on WIN SOURCE

 [ON Semiconductor](#) Information

## Optimize Your Supply Chain with WIN SOURCE Solutions

-  Global Sourcing Solution
-  Obsolete Management
-  Cost Control Management
-  Shortage Management
-  Alternative Solution
-  Excess Inventory Management