



# THE DATASHEET OF TDA2030H



## 14W Hi-Fi AUDIO AMPLIFIER

### DESCRIPTION

The TDA2030 is a monolithic integrated circuit in Pentawatt® package, intended for use as a low frequency class AB amplifier. Typically it provides 14W output power ( $d = 0.5\%$ ) at 14V/4Ω; at  $\pm 14V$  or 28V, the guaranteed output power is 12W on a 4Ω load and 8W on a 8Ω (DIN45500).

The TDA2030 provides high output current and has very low harmonic and cross-over distortion.

Further the device incorporates an original (and patented) short circuit protection system comprising an arrangement for automatically limiting the dissipated power so as to keep the working point of the output transistors within their safe operating area. A conventional thermal shut-down system is also included.

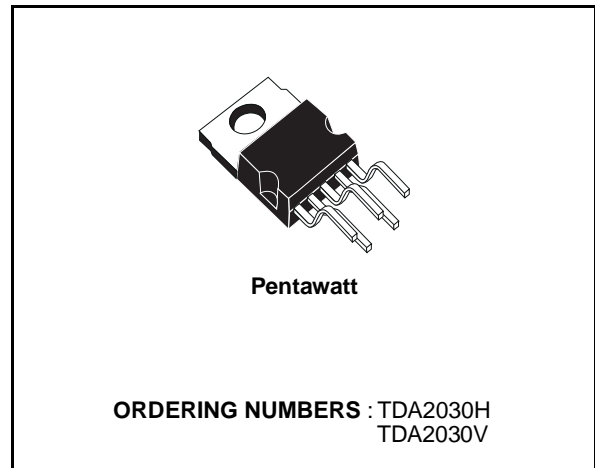

### ABSOLUTE MAXIMUM RATINGS

Symbol	Parameter	Value	Unit
$V_s$	Supply voltage	$\pm 18$ (36)	V
$V_i$	Input voltage	$V_s$	
$V_i$	Differential input voltage	$\pm 15$	V
$I_o$	Output peak current (internally limited)	3.5	A
$P_{tot}$	Power dissipation at $T_{case} = 90^\circ C$	20	W
$T_{stg}, T_j$	Storage and junction temperature	-40 to 150	$^\circ C$

### TYPICAL APPLICATION

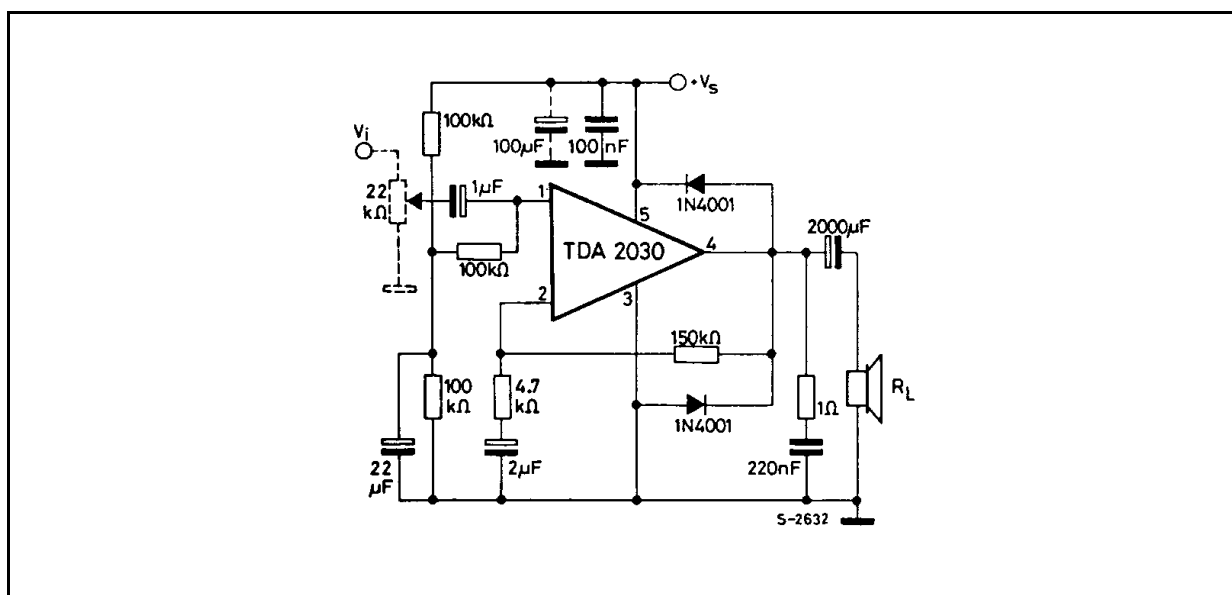

TDA2030

PIN CONNECTION (top view)

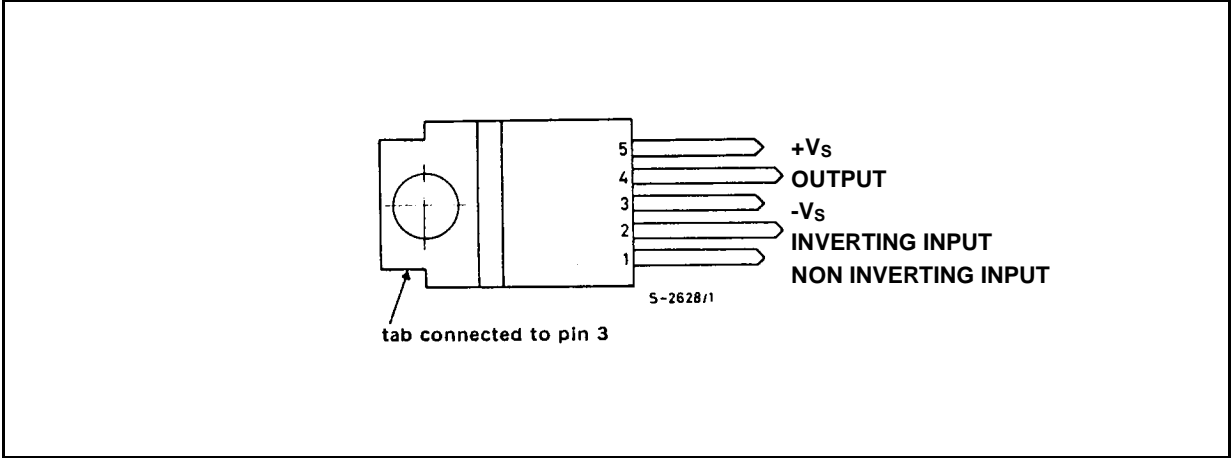

TEST CIRCUIT

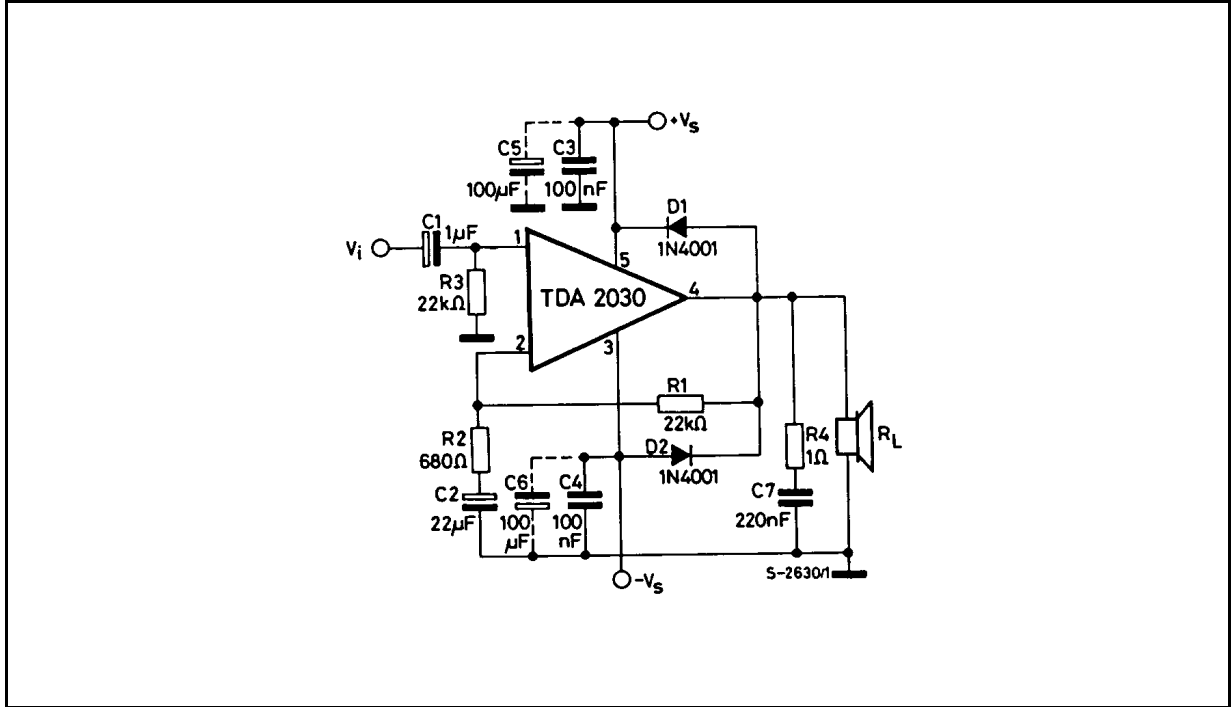

## THERMAL DATA

Symbol	Parameter	Value	Unit
$R_{th\ j-case}$	Thermal resistance junction-case	max 3	°C/W

**ELECTRICAL CHARACTERISTICS** (Refer to the test circuit,  $V_s = \pm 14V$ ,  $T_{amb} = 25^\circ C$  unless otherwise specified) for single Supply refer to fig. 15  $V_s = 28V$

Symbol	Parameter	Test conditions	Min.	Typ.	Max.	Unit
$V_s$	Supply voltage		$\pm 6$ 12		$\pm 18$ 36	V
$I_d$	Quiescent drain current	$V_s = \pm 18V$ ( $V_s = 36V$ )		40	60	mA
$I_b$	Input bias current			0.2	2	$\mu A$
$V_{os}$	Input offset voltage			$\pm 2$	$\pm 20$	mV
$I_{os}$	Input offset current			$\pm 20$	$\pm 200$	nA
$P_o$	Output power	$d = 0.5\%$ $G_v = 30\ dB$ $f = 40\ to\ 15,000\ Hz$ $R_L = 4\ \Omega$ $R_L = 8\ \Omega$	12 8	14 9		W W
		$d = 10\%$ $G_v = 30\ dB$ $f = 1\ KHz$ $R_L = 4\ \Omega$ $R_L = 8\ \Omega$		18 11		W W
d	Distortion	$P_o = 0.1\ to\ 12W$ $R_L = 4\ \Omega$ $G_v = 30\ dB$ $f = 40\ to\ 15,000\ Hz$		0.2	0.5	%
		$P_o = 0.1\ to\ 8W$ $R_L = 8\ \Omega$ $G_v = 30\ dB$ $f = 40\ to\ 15,000\ Hz$		0.1	0.5	%
B	Power Bandwidth (-3 dB)	$G_v = 30\ dB$ $P_o = 12W$ $R_L = 4\ \Omega$	10 to 140,000			Hz
$R_i$	Input resistance (pin 1)		0.5	5		M $\Omega$
$G_v$	Voltage gain (open loop)			90		dB
$G_v$	Voltage gain (closed loop)	$f = 1\ kHz$	29.5	30	30.5	dB
$e_N$	Input noise voltage	B = 22 Hz to 22 KHz		3	10	$\mu V$
$i_N$	Input noise current			80	200	pA
SVR	Supply voltage rejection	$R_L = 4\ \Omega$ $G_v = 30\ dB$ $R_g = 22\ k\ \Omega$ $V_{ripple} = 0.5\ V_{eff}$ $f_{ripple} = 100\ Hz$	40	50		dB
$I_d$	Drain current	$P_o = 14W$ $R_L = 4\ \Omega$		900		mA
		$P_o = W$ $R_L = 8\ \Omega$		500		mA

Figure 1. Output power vs. supply voltage

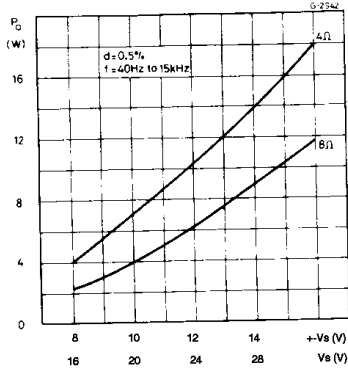

Figure 2. Output power vs. supply voltage

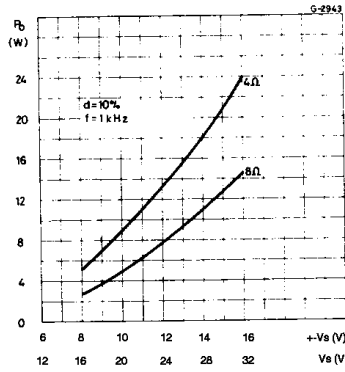

Figure 3. Distortion vs. output power

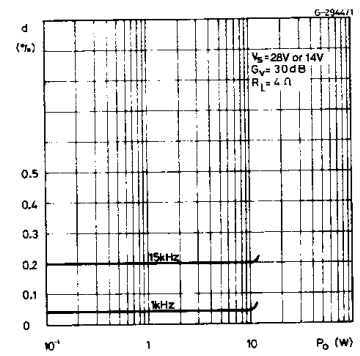

Figure 4. Distortion vs. output power

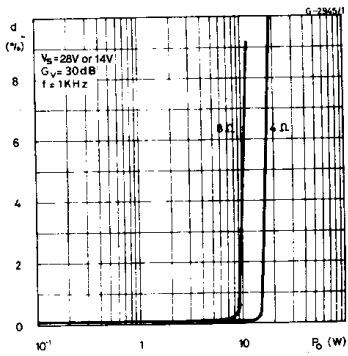

Figure 5. Distortion vs. output power

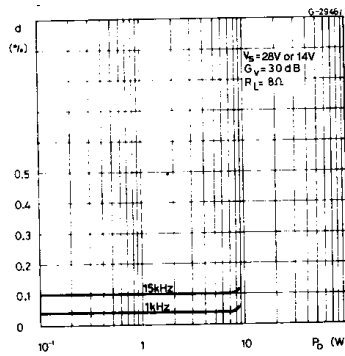

Figure 6. Distortion vs. frequency

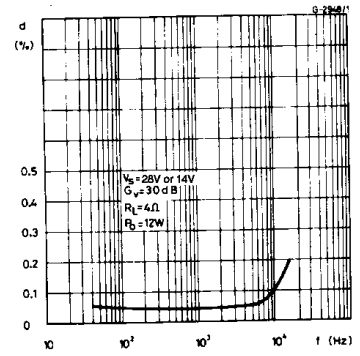

Figure 7. Distortion vs. frequency

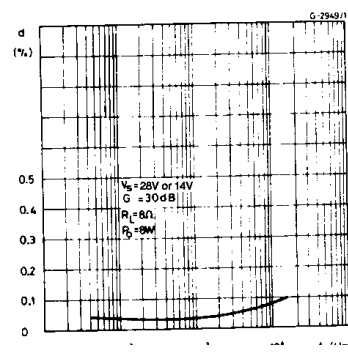

Figure 8. Frequency response with different values of the rolloff capacitor C8 (see fig. 13)

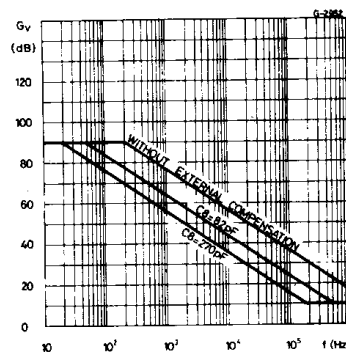

Figure 9. Quiescent current vs. supply voltage

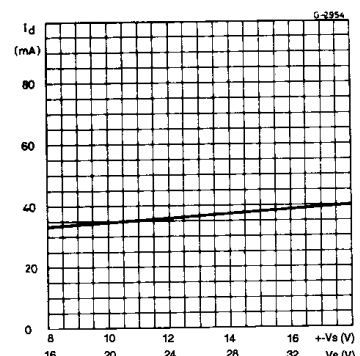

Figure 10. Supply voltage rejection vs. voltage gain

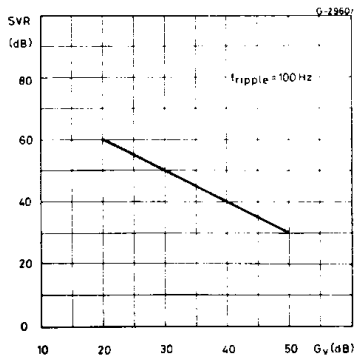

Figure 11. Power dissipation and efficiency vs. output power

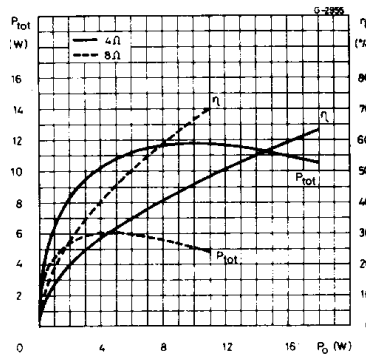
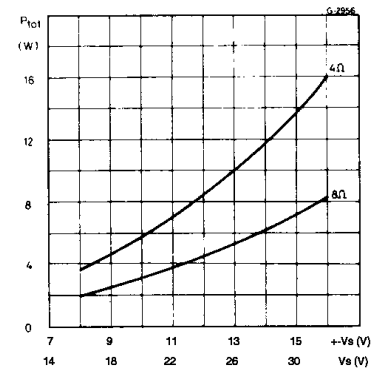

Figure 12. Maximum power dissipation vs. supply voltage (sine wave operation)



APPLICATION INFORMATION

Figure 13. Typical amplifier with split power supply

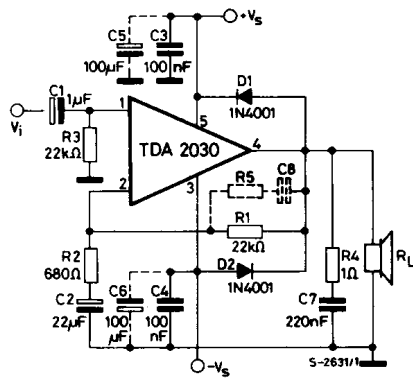
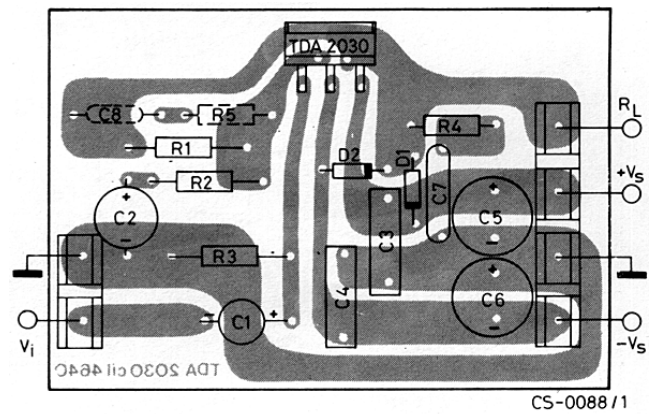

Figure 14. P.C. board and component layout for the circuit of fig. 13 (1 : 1 scale)





## PRACTICAL CONSIDERATIONS

### Printed circuit board

The layout shown in Fig. 16 should be adopted by the designers. If different layouts are used, the ground points of input 1 and input 2 must be well decoupled from the ground return of the output in which a high current flows.

### Assembly suggestion

No electrical isolation is needed between the

package and the heatsink with single supply voltage configuration.

### Application suggestions

The recommended values of the components are those shown on application circuit of fig. 13. Different values can be used. The following table can help the designer.

Component	Recomm. value	Purpose	Larger than recommended value	Smaller than recommended value
R1	22 k $\Omega$	Closed loop gain setting	Increase of gain	Decrease of gain (*)
R2	680 $\Omega$	Closed loop gain setting	Decrease of gain (*)	Increase of gain
R3	22 k $\Omega$	Non inverting input biasing	Increase of input impedance	Decrease of input impedance
R4	1 $\Omega$	Frequency stability	Danger of oscillat. at high frequencies with induct. loads	
R5	$\cong 3 R2$	Upper frequency cutoff	Poor high frequencies attenuation	Danger of oscillation
C1	1 $\mu\text{F}$	Input DC decoupling		Increase of low frequencies cutoff
C2	22 $\mu\text{F}$	Inverting DC decoupling		Increase of low frequencies cutoff
C3, C4	0.1 $\mu\text{F}$	Supply voltage bypass		Danger of oscillation
C5, C6	100 $\mu\text{F}$	Supply voltage bypass		Danger of oscillation
C7	0.22 $\mu\text{F}$	Frequency stability		Danger of oscillation
C8	$\cong \frac{1}{2\pi B R1}$	Upper frequency cutoff	Smaller bandwidth	Larger bandwidth
D1, D2	1N4001	To protect the device against output voltage spikes		

(\*) Closed loop gain must be higher than 24dB

## SINGLE SUPPLY APPLICATION

Component	Recomm. value	Purpose	Larger than recommended value	Smaller than recommended value
R1	150 kΩ	Closed loop gain setting	Increase of gain	Decrease of gain (*)
R2	4.7 kΩ	Closed loop gain setting	Decrease of gain (*)	Increase of gain
R3	100 kΩ	Non inverting input biasing	Increase of input impedance	Decrease of input impedance
R4	1 Ω	Frequency stability	Danger of oscillat. at high frequencies with induct. loads	
R <sub>A</sub> /R <sub>B</sub>	100 kΩ	Non inverting input Biasing		Power Consumption
C1	1 μF	Input DC decoupling		Increase of low frequencies cutoff
C2	22 μF	Inverting DC decoupling		Increase of low frequencies cutoff
C3	0.1 μF	Supply voltage bypass		Danger of oscillation
C5	100 μF	Supply voltage bypass		Danger of oscillation
C7	0.22 μF	Frequency stability		Danger of oscillation
C8	$\cong \frac{1}{2\pi B R1}$	Upper frequency cutoff	Smaller bandwidth	Larger bandwidth
D1, D2	1N4001	To protect the device against output voltage spikes		

(\*) Closed loop gain must be higher than 24dB

## SHORT CIRCUIT PROTECTION

The TDA2030 has an original circuit which limits the current of the output transistors. Fig. 18 shows that the maximum output current is a function of the collector emitter voltage; hence the output transistors work within their safe operating area (Fig. 2). This function can therefore be considered as being

peak power limiting rather than simple current limiting.

It reduces the possibility that the device gets damaged during an accidental short circuit from AC output to ground.

**Figure 18. Maximum output current vs. voltage [ $V_{CEsat}$ ] across each output transistor**

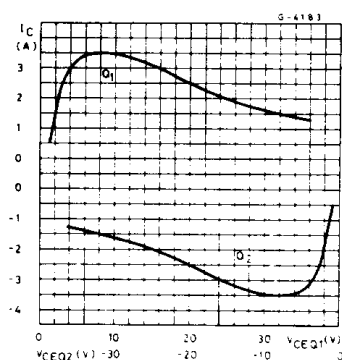

**Figure 19. Safe operating area and collector characteristics of the protected power transistor**

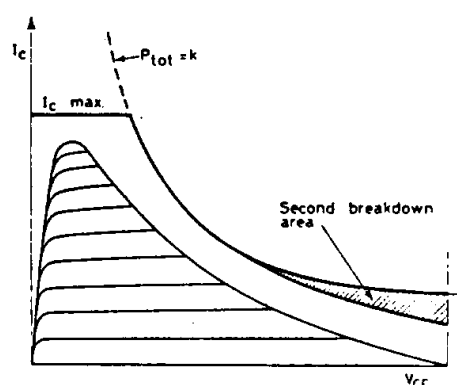

## THERMAL SHUT-DOWN

The presence of a thermal limiting circuit offers the following advantages:

1. An overload on the output (even if it is permanent), or an above limit ambient temperature can be easily supported since the  $T_j$  cannot be higher than  $150^\circ\text{C}$ .
2. The heatsink can have a smaller factor of safety compared with that of a conventional circuit. There is no possibility of device damage due to high junction temperature. If for any reason, the

junction temperature increases up to  $150^\circ\text{C}$ , the thermal shut-down simply reduces the power dissipation at the current consumption.

The maximum allowable power dissipation depends upon the size of the external heatsink (i.e. its thermal resistance); fig. 22 shows this dissipable power as a function of ambient temperature for different thermal resistance.

Figure 20. Output power and drain current vs. case temperature ( $R_L = 4\Omega$ )

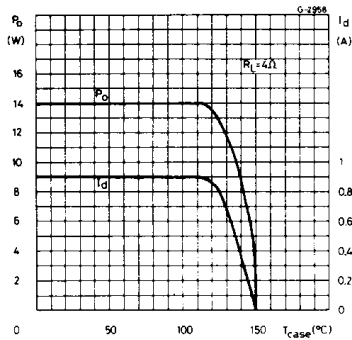

Figure 21. Output power and drain current vs. case temperature ( $R_L = 8\Omega$ )

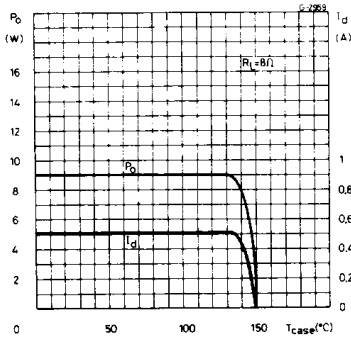

Figure 22. Maximum allowable power dissipation vs. ambient temperature

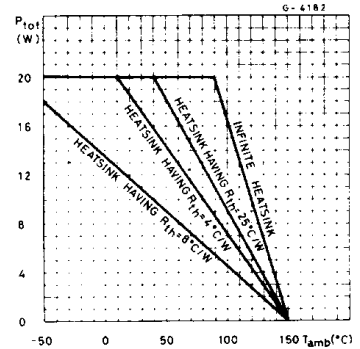
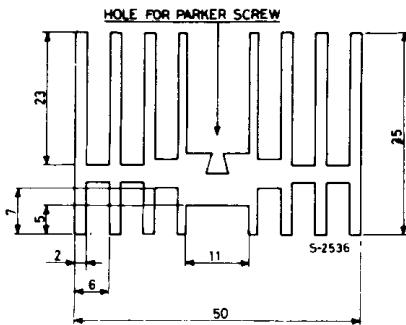

Figure 23. Example of heat-sink



Dimension : suggestion.

The following table shows the length that the heatsink in fig. 23 must have for several values of  $P_{tot}$  and  $R_{th}$ .

$P_{tot}$ (W)	12	8	6
Length of heatsink (mm)	60	40	30
$R_{th}$ of heatsink ( $^{\circ}C/W$ )	4.2	6.2	8.3

## PENTAWATT PACKAGE MECHANICAL DATA

DIM.	mm			inch		
	MIN.	TYP.	MAX.	MIN.	TYP.	MAX.
A			4.8			0.189
C			1.37			0.054
D	2.4		2.8	0.094		0.110
D1	1.2		1.35	0.047		0.053
E	0.35		0.55	0.014		0.022
E1	0.76		1.19	0.030		0.047
F	0.8		1.05	0.031		0.041
F1	1		1.4	0.039		0.055
G	3.2	3.4	3.6	0.126	0.134	0.142
G1	6.6	6.8	7	0.260	0.268	0.276
H2			10.4			0.409
H3	10.05		10.4	0.396		0.409
L	17.55	17.85	18.15	0.691	0.703	0.715
L1	15.55	15.75	15.95	0.612	0.620	0.628
L2	21.2	21.4	21.6	0.831	0.843	0.850
L3	22.3	22.5	22.7	0.878	0.886	0.894
L4			1.29			0.051
L5	2.6		3	0.102		0.118
L6	15.1		15.8	0.594		0.622
L7	6		6.6	0.236		0.260
L9		0.2			0.008	
M	4.23	4.5	4.75	0.167	0.177	0.187
M1	3.75	4	4.25	0.148	0.157	0.167
V4	40° (typ.)					
Dia	3.65		3.85	0.144		0.152

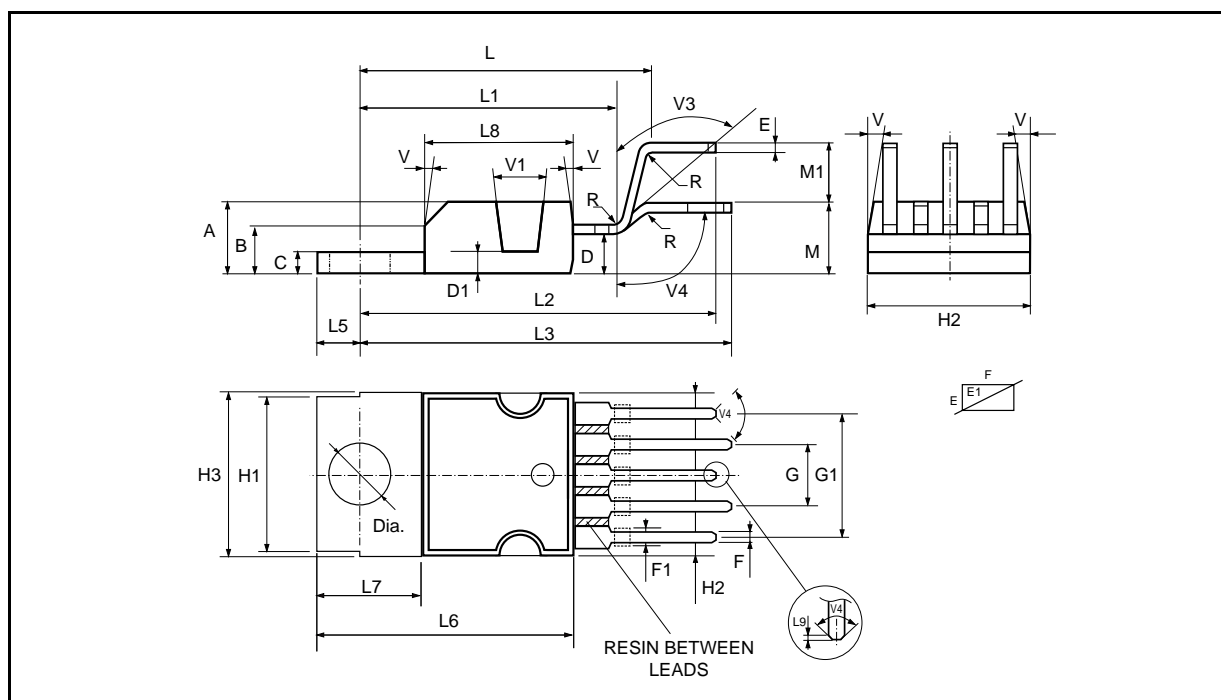



Information furnished is believed to be accurate and reliable. However, STMicroelectronics assumes no responsibility for the consequences of use of such information nor for any infringement of patents or other rights of third parties which may result from its use. No license is granted by implication or otherwise under any patent or patent rights of STMicroelectronics. Specification mentioned in this publication are subject to change without notice. This publication supersedes and replaces all information previously supplied. STMicroelectronics products are not authorized for use as critical components in life support devices or systems without express written approval of STMicroelectronics.

The ST logo is a registered trademark of STMicroelectronics  
© 1998 STMicroelectronics – Printed in Italy – All Rights Reserved  
STMicroelectronics GROUP OF COMPANIES

Australia - Brazil - Canada - China - France - Germany - Italy - Japan - Korea - Malaysia - Malta - Mexico - Morocco - The Netherlands - Singapore - Spain - Sweden - Switzerland - Taiwan - Thailand - United Kingdom - U.S.A.

## Looking for pricing, stock, or lifecycle information?

Click below to explore more details on WIN SOURCE:

-  [View TDA2030H](#) on WIN SOURCE
-  [STMicroelectronics](#) Information

## Optimize Your Supply Chain with WIN SOURCE Solutions

-  Global Sourcing Solution
-  Obsolete Management
-  Cost Control Management
-  Shortage Management
-  Alternative Solution
-  Excess Inventory Management