



**THE DATASHEET OF**  
**1024**



# SMT LOW PROFILE LITHIUM & ALKALINE CELL HOLDERS

"1/3N" • "AAA" • "1/2AA" • "AA" • "2/3A"

## FEATURES

- Low profile surface mount holders for Cylindrical Lithium and Alkaline batteries
- UL 94V-0 Heat resistant Nylon Housings well suited for reflow soldering
- Designed for vacuum pick and place assembly
- Gold-plated Phosphor Bronze contacts assure low contact resistance and are readily solderable

- Ideal for both lead free solder and traditional solder process
- Battery installation and removal does not require tools
- Securely holds battery in place
- Polarity clearly marked for orientation
- Operating temp range: -60°F to +290°F (-50°C to +145°C)

## APPLICATIONS

- Computer memory, power backup systems
- Telecommunications
- Residential, industrial and commercial security systems
- PLC and industrial controls

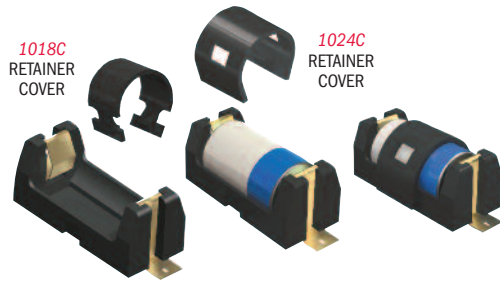

## SPECIFICATIONS

**Base:** High Temp Nylon 46, UL 94V-0

**Contacts:** .012 (.30) Stainless Steel, Gold Plate (Flash)

CAT. NO.	COVER	L	W	H (REF)	B	G	CELL SIZE	PACKAGING SPECS	BATTERY CROSS REFERENCE
1016	1024C	1.723 (43.8)	.612 (15.5)	.603 (15.3)	1.360 (34.5)	.265 (6.7)	"1/2AA"	50 pieces per tray	Energizer 544, Duracell PX28L, Kodak K28A & KS28, Panasonic CR14250, Saft LCP3, Maxell
1024	1024C	2.711 (68.9)	.612 (15.5)	.603 (15.3)	2.359 (59.9)	.265 (6.7)	"AA"	50 pieces per tray	Energizer, Duracell, Panasonic, Sanyo, Varta, Rayovac, Tadiran,
1018	1018C	2.062 (52.3)	.720 (18.3)	.682 (17.3)	1.690 (42.9)	.319 (8.1)	"2/3A"	50 pieces per tray	Duracell DL2/3A, Kodak K123L, Saft 450SC & VR0450, Sanyo CR17335SE

## SMT ULTRA LOW PROFILE

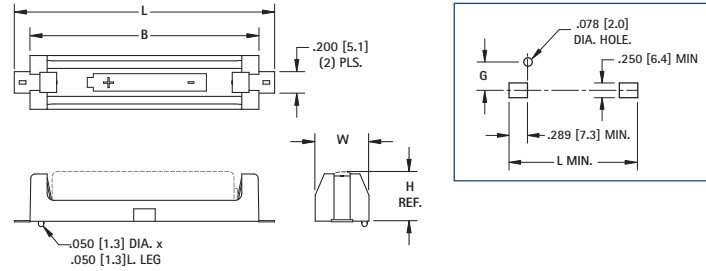

## SMT ULTRA LOW PROFILE

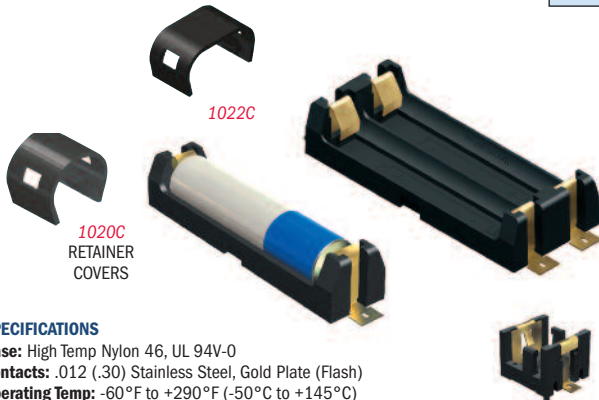

## SPECIFICATIONS

**Base:** High Temp Nylon 46, UL 94V-0

**Contacts:** .012 (.30) Stainless Steel, Gold Plate (Flash)

**Operating Temp:** -60°F to +290°F (-50°C to +145°C)

**Packaging Spec's:** Supplied in trays

## SINGLE

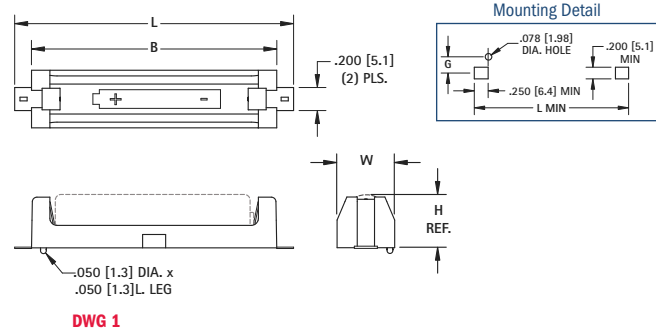

## DUAL

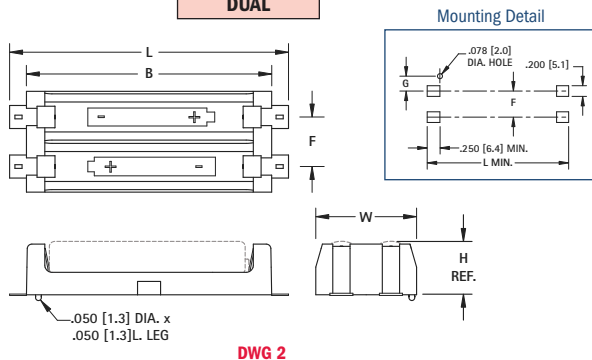

## "1/3N"

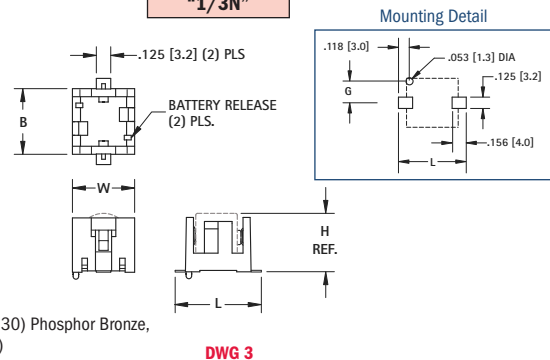



**Contacts:** .012 (.30) Phosphor Bronze, Gold Plate (Flash)







CAT. NO.	COVER	DWG NO.	L	W	H (REF)	B	F	G	CELL SIZE	PACKAGING SPECS	BATTERY CROSS REFERENCE
1020	1020C	1	2.421 (61.5)	.500 (12.7)	.445 (11.3)	2.140 (54.4)	-	.209 (5.3)	"AAA"	50 pieces per tray	All Major Manufacturers
1022	1022C	2	2.421 (61.5)	.875 (22.2)	.445 (11.3)	2.140 (54.4)	.430 (10.9)	.182 (4.6)	"AAA"	25 pieces per tray	All Major Manufacturers
1024	1024C	1	2.711 (68.9)	.612 (15.5)	.603 (15.3)	2.359 (59.9)	-	.265 (6.7)	"AA"	50 pieces per tray	All Major Manufacturers
1012	1012C	2	2.711 (68.9)	1.180 (30.0)	.603 (15.3)	2.359 (59.9)	.568 (14.4)	.265 (6.7)	"AA"	25 pieces per tray	All Major Manufacturers
1018	1018C	1	2.062 (52.3)	.720 (18.3)	.682 (17.3)	1.690 (42.9)	-	.319 (8.1)	"2/3A"	50 pieces per tray	Duracell DL2/3A, Kodak K123L, Saft 450SC & VR0450
1100	-	2	2.062 (52.3)	1.440 (36.6)	.682 (17.3)	1.690 (42.9)	.720 (18.3)	.319 (8.1)	"2/3A"	25 pieces per tray	Sanyo CR17335SE
498	-	3	.748 (19.0)	.540 (13.7)	.506 (12.9)	.570 (14.5)	-	.240 (6.1)	"1/3N"	300 pieces per tray	Duracell DL1/3N, Sanyo K58L, Energizer CR1/3N

## Looking for pricing, stock, or lifecycle information?

Click below to explore more details on WIN SOURCE:

-  [View 1024 on WIN SOURCE](#)
-  [Keystone Electronics Information](#)

## Optimize Your Supply Chain with WIN SOURCE Solutions

-  Global Sourcing Solution
-  Obsolete Management
-  Cost Control Management
-  Shortage Management
-  Alternative Solution
-  Excess Inventory Management