



**THE DATASHEET OF
PS2525-1-A**



PHOTOCOUPPLERS SELCTION GUIDE



SUITABLE PRODUCT FOR EACH APPLICATIONS

Renesas offers an array of flexible products suitable for a wide range of applications.

Application Field	Application Name	Motor Drive		Current/ Voltage monitor	Communication		Transistor Output
		IGBT drive	IPM drive		Communication		
					Digital output	Analog output	
Industry	AC Servo	•	•	•	•	•	•
	NC machine tools	•	•	•	•	•	•
	GAS / Water / Electric power Meter				•	•	•
	Smart meter				•	•	•
	Service Robot						•
	Industrial Robot	•	•	•	•	•	•
	Buttery system	•	•	•	•	•	•
	Solar power conditioner	•	•	•	•	•	•
	UPS	•	•	•	•	•	•
	Welding machine	•	•	•	•	•	•
	Semiconductor manufacturing equipment				•	•	•
	Tester / measurement device	•	•		•	•	•
	PLC	•	•		•	•	•
	Network Camera				•		•
	Vending machine	•				•	•
	Electric tools	•	•		•	•	•
	Security sensor , camera		•		•	•	•
Industrial LED light						•	
Communication	Server						•
	Network Switch				•	•	•
	Router				•		•
	Wireless base station				•		•
	Line-phone				•		•
	Infrastructure Switch		•		•		•
	Broadcast apparatus						•
Consumer	Video / Audio		•		•	•	•
	TB				•		•
	STB						•
	Camera		•		•	•	•
	Game(Portable / Stationary)						•
	Pachinko				•	•	•
	Air Conditioner	•	•		•	•	•
	Lightings				•	•	•
	Washing machine		•		•	•	•
	Refrigerator	•					•
IH Cooker	•			•	•	•	
OA	Scanner						•
	HDD						•
	POS				•	•	•
	PPC / Printer				•		•
	Server / Workstation / Super Comsuter	•	•		•	•	•
	Desktop PC				•		•
	Mobile PC / Tablet				•		•
Monitor						•	

PHOTOCOUPLER LINE-UP

Renesas offers photocouplers targeted to specific applications, from high-speed products for motor drive and communication to general-purpose Tr. output products.

Visit our website.



<https://www.renesas.com/products/interface-connectivity/optoelectronics>

IC-Output

Creepage Isolation Voltage Pin pitch

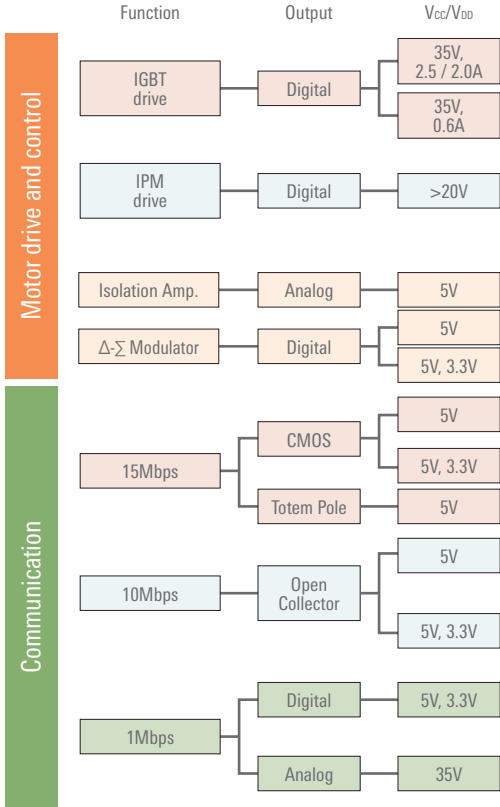

DIP8 7/8 mm 5 kV 2.54 mm	SDIP 7/8 mm 5 kV 1.27 mm	LSDIP8 15 mm 7.5 kV 1.27 mm	LSO5 8 mm 5 kV 1.27 mm	S05 4.2 mm 3.75 kV 1.27 mm	LSS05 8.2 mm 5 kV 0.65 mm	S08 4 mm 2.5 kV 1.27 mm	S016 8 mm 5 kV 1.27 mm
PS9531	PS9331 PS9332	PS9905	PS9031		RV1S9231A		PS9402
PS9506	PS9307A				RV1S9207A		
PS9513	PS9313		PS9013 RV1S9062A	PS9113 RV1S9162A	RV1S9213A RV1S9262A		
	PS9303 PS9309		PS9009 RV1S9061A	RV1S9161A	RV1S9209A RV1S9261A		
PS8551A	PS8352A						
PS9551A							
	RV1S9353A						
	PS9351			PS9151		PS9851-1 PS9851-2	
		RV1S9960A	RV1S9060A	RV1S9160A	RV1S9260A		
				PS9123			
PS9587	PS9317		PS9001	PS9117A		PS9817A-1 PS9817A-2	
	PS9324	PS9924		PS9124		PS9821-1 PS9821-2	
				PS9122		PS9822-1 PS9822-2	
PS8501 PS8502	PS8302	PS8902		PS8101		PS8802-1 PS8802-2	

Transistor-Output

Creepage Isolation Voltage Pin pitch

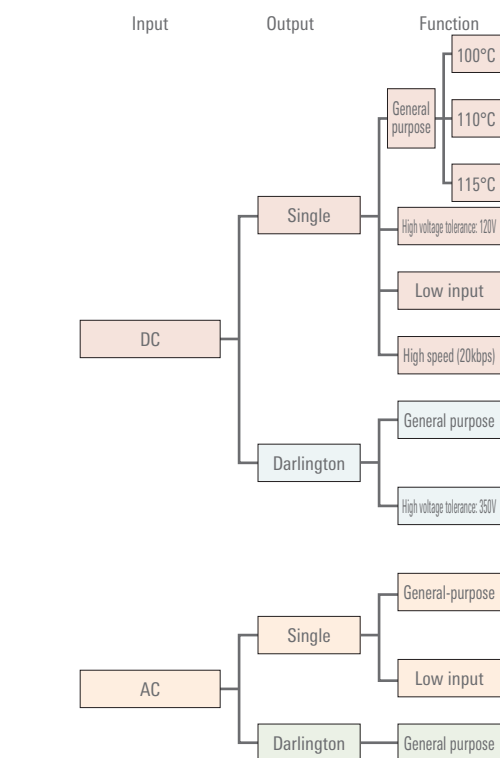

DIP4 7/8 mm 5 kV 2.54 mm	LSOP 8 mm 5 kV 2.54 mm	SOP 5 mm 3.75 kV 2.54 mm	LSSOP 8.2 mm 5 kV 1.3 mm	SSOP 4/4.5/5 mm 1.5/2.5/3.75 kV 0.8/1.27 mm	Flat lead 4 mm 2.5 kV 1.27 mm
		PS2701A-1		PS2801C-1/4	
PS2561D-1 PS2561F-1		PS2761B-1		PS2861B-1	
	PS2381-1		RV1S2281A		
		PS2703-1			PS2913-1
		PS2711-1	RV1S2211A	PS2811-1/4 PS2841-4A/4B	PS2911-1
PS2514-1					
PS2562-1		PS2702-1		PS2802-1/4	
PS2533-1 PS2535-1		PS2733-1		PS2833-1/4	PS2933-1
PS2565-1		PS2705A-1	RV1S2285A	PS2805C-1/4	
		PS2715-1		PS2815-1/4 PS2845-4A	PS2915-1
PS2506-1		PS2706-1			

PHOTOCOUPLER PRODUCTS

SELECTION GUIDE

IGBT Drive

Function	Part No.	Output Peak Current [A]	Power Supply Voltage [V]	Package		Isolation Voltage [Vr.m.s.]	Ta max. [°C]	Electrical Characteristics					Protection Functions		
				Configuration	Creepage Distance [mm]			DC	SW			Protection			
									IFLH max. [mA]	tpHL,LH max. [ns]	PWD max. [ns]	PDD [ns]	CMR min. [kV/μs]	UVLO	Clamp
IGBT Drive	PS9307A	0.6	10 to 30	SDIP6	L:7 L2:8	5000	125	5.0	150	50	-80 to 80	50	○	-	-
	RV1S9207A			LSS05	8.2	5000	125	5.0	150	50	-80 to 80	50	○	-	-
	PS9506			DIP8	-/L3:7 L1/L2:8	5000	110	7.0	400	250	-300 to 300	25	-	-	-
	PS9031	2.5	15 to 30	LS05	8	5000	125	4.0	175	75	-90 to 90	50	○	-	-
	RV1S9231A			LSS05	8.2	5000	125	5.2	175	75	-90 to 90	50	○	-	-
	PS9331			SDIP6	L:7 L2:8	5000	125	4.0	175	75	-90 to 90	50	○	-	-
	PS9531			DIP8	-/L3:7 L1/L2:8	5000	125	4.0	175	75	-90 to 90	50	○	-	-
	PS9905			LSDIP8	15	7500	110	6.0	150	75	-100 to 100	25	○	-	-
	PS9332	2	15 to 30	SDIP8	L:7 L2:8	5000	125	4.0	200	75	-90 to 90	50	○	○	-
	PS9402	2.5	15 to 30	SO16	8	5000	110	5.0	200	100	-100 to 100	25	○	○	○

IPM Drive

Function	Part No.	Output Type	Logic	Package		Recommended Operating Conditions	Absolute Maximum Ratings		Electrical Characteristics						
				Configuration	Creepage Distance [mm]		Power Supply Voltage [V]	Isolation Voltage [Vr.m.s.]	Ta max. [°C]	DC	SW			CMR min. [kV/μs]	
											IFHL/LH max. [mA]	tpHL/LH max. [ns]	PWD max. [ns]		PDD max. [ns]
IPM Drive	RV1S9161A	Totem Pole	Active High	S05	4.2	4.5 to 30	3750	125	3.0	60	20	25	100		
	PS9009			LS05	8	4.5 to 20	5000	125	3.0	200	80	100	50		
	RV1S9061A					4.5 to 30	5000	125	4.5	60	20	25	100		
	RV1S9209A			LSS05	8.2	4.5 to 20	5000	125	3.8	200	80	100	50		
	RV1S9261A					4.5 to 30	5000	125	4.0	60	20	25	100		
	PS9309					SDIP6	L:7 L2:8	4.5 to 20	5000	110	3.0	200	80	80	15
	PS9303			SDIP6	L:7 L2:8	4.5 to 20	5000	100	5.0	500	350	-	15		
	RV1S9162A			Open Collector	Active Low	S05	4.2	4.5 to 30	3750	125	3.0	60	20	25	100
	RV1S9062A					LS05	8	4.5 to 30	5000	125	4.1	60	20	25	100
	RV1S9262A					LSS05	8.2	4.5 to 30	5000	125	4.0	60	20	25	100
	PS9513	DIP8	-/L3:7 L1/L2:8			4.5 to 20	5000	100	5.0	500 750	650	650	15		
	PS9013	LS05	8			4.5 to 25	5000	125	5.0	500 750	650	650	50		
	RV1S9213A	LSS05	8.2			4.5 to 25	5000	125	5.0	500/750	650	650	50		
	PS9313	SDIP6	L:7 L2:8			4.5 to 20	5000	110	5.0	500 750	650	650	15		
	PS9113	S05	4.2			4.5 to 20	3750	100	5.0	500 750	650	650	15		

Isolation Amplifiers

Function	Part No.	Output	Package		Absolute Maximum Ratings		Electrical Characteristics							
			Configuration	Creepage Distance [mm]	Isolation Voltage [Vr.m.s.]	Ta max. [°C]	Input Voltage Linearity Range [mV]	Gain typ. [V/V]	Gain Error Max. [%]	NL typ. [%]	VDD2 [V]	CMR min. [kV/μs]	fc typ. [kHz]	Output Type
Isolation amplifier	PS8551A	Analog	DIP8	8	5000	105	-200 to 200	8	1	0.014	5	10	100	Differential
	PS8352A		SDIP8	8	5000	110	-200 to 200	8	1	0.014	5	10	100	Differential

Δ-Σ Modulators

Function	Part No.	Output	Package		Absolute Maximum Ratings		Electrical Characteristics						
			Configuration	Creepage Distance [mm]	Isolation Voltage [Vr.m.s.]	Ta max. [°C]	Input Voltage Linearity Range [mV]	Gain Error Max. [%]	INL typ. [LSB]	VDD2 [V]	ENOB typ. [bits]	CMR min. [kV/μs]	fCLK typ. [MHz]
Δ-Σ Modulators	PS9551A	Digital	DIP8	8	5000	105	-200 to 200	1	3	5	12	15	10
	RV1S9353A		SDIP8	8	5000	110	-200 to 200	0.5	3	3.3/5	13.8	15	10

High-Speed Communication (Analog)

Function	Part No.	Speed [bps]	Output Type	Absolute Maximum Rated Power Supply Voltage [V]	Package		Isolation Voltage [Vr.m.s.]	Ta max. [°C]	Electrical Characteristics						
					Configuration	Creepage Distance [mm]			Detector				Coupled		
									IOH @Vcc30V max. [μA]	VOL max. [V]	ICCL typ. [μA]	ICCH max. [μA]	CTR@ IF 16mA Vcc 4.5V Vo 0.4V [%]	tpHL/LH max. [ns]	CMR min. [kV/μs]
High-Speed Communication (Analog)	PS8101	1M	Open Collector	35	S05	4.2	3750	100	100	0.4	50	2	15 to 35	800/1200	15
	PS8802-1/-2				S08	4.0	2500	100	100	0.4	100/200	2/4	15 and Over	800/1200	15
	PS8302				SDIP6	L:7 L2:8	5000	110	100	0.4	150	1	15 and Over	800/800	15
	PS8501				DIP8	-L3:7 L1/L2:8	5000	100	100	0.4	150	1	15 and Over	800/800	-
	PS8502								100	0.4	150	1	15 and Over	800/800	15
	PS8902				LSDIP8	15	7500	110	100	0.4	50	2	15 to 35	800/1200	15

High-Speed Communication (Digital)

Function	Part No.	Speed [bps]	Output Type	Power Supply Voltage [V]	Package		Isolation Voltage [Vr.m.s.]	Ta max. [°C]	DC			AC				
					Configuration	Creepage Distance [mm]			VOL max. [V]	VOH min. [V]	ICCL/H max. [mA]	IFHL max. [mA]	tpHL/LH max. [ns]	PWD max. [ns]	tpsk max. [ns]	CMR min. [kV/μs]
High-Speed Communication (Digital)	PS9122	1M	Open Collector	N 2.7~3.6, L 4.5~5.5	S05	4.2	3750	100	0.6	-	3.5/2.5	5.0	500/700	200	-	15
	PS9822-1/-2				S08	4.0	2500	100	0.6	-	3.5/2.5	5.0	500/700	200	-	-
	PS9124				S05	4.2	3750	110	0.6	-	10/7	3.0	100/100	35	40	10
	PS9324	10M	Open Collector	2.7~3.6 & 4.5~5.5	SDIP6	L:7 L2:8	5000	110	0.6	-	10/7	3.0	100/100	35	40	15
	PS9924				LSDIP8	15	7500	110	0.6	-	10/7	5.0	100/100	35	40	15
	PS9821-1/-2				S08	4.0	2500	85	0.6	-	10/7	5.0	100/100	35	40	15
	PS9587				DIP8	-L3:7 L1/L2:8	5000	85	0.6	-	11/8	5.0	100/100	50	60	15
	PS9317				SDIP6	L:7 L2:8	5000	85	0.6	-	10/7	5.0	75/75	35	40	15
	PS9001				LS05	8.0	5000	125	0.6	-	2/2	4.0	100/100	50	60	50
	PS9117A	S05	4.2	3750	85	0.6	-	10/7	5.0	100/100	35	40	15			
	PS9817A-1/-2	S08	4.0	2500	85	0.6	-	10/7	5.0	100/100	35	40	15			
	PS9123	15M	Totem Pole	4.5~5.5	S05	4.2	3750	100	0.6	2.4	10/7	5.0	60/60	30	-	15
	PS9151				S05	4.2	3750	100	0.1	4.0	5/5	5.0	60/60	30	40	15
	RV1S9160A				S05	4.2	3750	125	0.1	VDD-0.1	2/2	2	60/60	20	25	50
	PS9851-1/-2				S08	4.0	2500	100	0.1	4.0	5/5	6.0	60/60	30	40	10
	RV1S9060A				LS05	8	5000	125	0.1	VDD-0.1	2/2	2.2	60/60	20	25	50
	RV1S9260A				LSS05	8.2	5000	125	0.1	VDD-0.1	2/2	2.6	60/60	20	25	50
PS9351	SDIP6				L:7 L2:8	5000	100	0.1	4.0	5/5	5.0	60/60	30	40	15	
RV1S9960A	LSDIP8	15	7500	110	0.1	VDD-0.1	2/2	3.8	60/60	20	25	50				

Transistor-Output (DC Input) Single

Function	Part No.	Output Type	Package		Absolute Maximum Ratings				Electrical Characteristics				
			Configuration	Creepage Distance [mm]	VCEO max. [V]	IC max. [mA]	Isolation Voltage [Vr.m.s.]	Ta max. [°C]	DC	SW			
									CTR %	tr typ. [μs]	tf typ. [μs]	ton typ. [μs]	toff typ. [μs]
Transistor-Output (DC Input)	PS2561D-1	Single	DIP4	-/L:7 L1/L2:8	80	50	5000	110	50 to 400	3	5	–	–
	PS2561F-1		DIP4	7	80	50	5000	110	300 to 600	5	7	–	–
	PS2514-1		DIP4	7	40	20	5000	100	50 to 200	–	–	15	15
	PS2381-1		LSOP4	8	80	50	5000	115	50 to 400	4	5	–	–
	RV1S2281A		LSSOP	8.2	80	30	5000	115	50 to 400	4	5	–	–
	PS2701A-1		SOP4	5	70	30	3750	100	50 to 300	5	7	8	10
	PS2761B-1		SOP4	5	70	50	3750	110	50 to 400	4	5	8	5
	PS2703-1		SOP4	5	120	30	3750	100	50 to 400	10	10	13	11
	PS2711-1		SOP4	5	40	40	3750	100	100 to 400	4	5	–	–
	PS2801C-1		SSOP4	4.5	80	30	2500	100	50 to 400	5	7	10	7
	PS2801C-4		SSOP16	4.5	80	30	2500	100	50 to 400	5	7	10	7
	PS2861B-1		SSOP4	5	70	50	3750	110	50 to 300	4	5	5	5
	PS2811-1		SOP4	4.5	40	40	2500	100	100 to 400	4	5	7	5
	PS2811-4		SSOP16	4.5	40	40	2500	100	100 to 400	4	5	7	5
	RV1S2211A		LSSOP	8.2	40	40	5000	115	100 to 400	4	5	–	–
	PS2841-4A		SSOP12	4	70	20	1500	100	100 to 400	–	–	20	110
	PS2841-4B		SSOP12	4	70	20	1500	100	100 to 400	–	–	20	110
	PS2911-1		Flat Leads	4	40	40	2500	100	100 to 400	5	10	40	120
PS2913-1	Flat Leads	4	120	30	2500	100	50 to 200	10	10	80	50		

Transistor-Output (DC Input) Darlington

Function	Part No.	Output Type	Absolute Maximum Ratings		Package		Isolation Voltage [Vr.m.s.]	Ta max. [°C]	Electrical Characteristics						
			VCEO [V]	IC [mA/ch]	Configuration	Creepage Distance [mm]			DC			SW			
									CTR min. [%]	CTR max. [%]	VCE SAT [V]	tr typ. [μs]	tf typ. [μs]	ton typ. [μs]	toff typ. [μs]
Transistor-Output (DC Input)	PS2802-1	Darlington	40	90	SSOP4	4.5	2500	100	200	–	1.0	200	200	–	–
	PS2802-4			100	SSOP16	4.5	2500	100	200	–	1.0	200	200	–	–
	PS2562-1			200	DIP4	7	5000	100	200	–	1.0	100	100	–	–
	PS2702-1			200	SOP4	5	3750	100	200	–	1.0	70	60	90	60
	PS2833-1		350	60	SSOP4	4.5	2500	100	400	4500	1.0	20	5	–	–
	PS2833-4			60	SSOP16	4.5	2500	100	400	4500	1.0	20	5	–	–
	PS2535-1			120	DIP4	7	5000	100	400	5500	1.0	18	5	–	–
	PS2533-1			150	DIP4	7	5000	100	1500	6500	1.0	100	100	–	–
	PS2733-1			150	SOP4	5	2500	100	1500	–	1.0	100	100	–	–
	PS2933-1			60	Flat Leads	4	2500	100	400	4500	1.0	20	5	–	–

Transistor-Output (AC Input)

Function	Part No.	Output Type	Package		Absolute Maximum Ratings				Electrical Characteristics					
			Configuration	Creepage Distance [mm]	VCEO max. [V]	IC max. [mA]	Isolation Voltage [Vr.m.s.]	Ta max. [°C]	DC	SW				
									CTR %	tr typ. [μs]	tf typ. [μs]	ton typ. [μs]	toff typ. [μs]	
Transistor-Output (AC Input)	PS2565-1	Single	DIP4	7	80	50	5000	100	80 to 400	3	5	–	–	
	PS2705A-1		SOP4	5	70	30	3750	100	50 to 300	5	7	8	10	
	PS2715-1		SOP4	5	40	40	3750	100	100 to 400	4	5	–	–	
	PS2805C-1		SSOP4	4.5	80	30	2500	100	50 to 400	5	7	10	7	
	PS2805C-4		SSOP16	4.5	80	30	2500	100	50 to 400	5	7	10	7	
	PS2815-1		SSOP4	4.5	40	40	2500	100	100 to 400	4	5	7	5	
	PS2815-4		SSOP16	4.5	40	40	2500	100	100 to 400	4	5	7	5	
	RV1S2285A		LSSOP	8.2	80	30	5000	115	50 to 400	4	5	–	–	
	PS2845-4A		SSOP12	4	70	20	1500	100	100 to 400	–	–	20	110	
	PS2915-1		Flat Leads	4	40	40	2500	100	100 to 400	5	10	40	120	
	PS2506-1		Darlington	DIP4	7	40	200	5000	100	200 min.	100	100	–	–
	PS2706-1			SOP4	5	40	200	3750	100	200 min.	200	200	–	–

PACKAGE DIMENSIONS 1

Unit : mm

LS05	DIP8	SDIP6 (L)
LSDIP8	DIP8 (L1)	SDIP6 (L2)
S016	DIP8 (L3)	SDIP8 (L)
DIP8 (L4)	DIP8 (L2)	SDIP8 (L2)

PACKAGE DIMENSIONS 2

Unit : mm

S05	DIP4	SSOP4
S08	DIP4 (L)	SSOP16
SOP	DIP4 (L1)	SSOP12
LSOP	DIP4 (L2)	Flat lead

PACKAGE DIMENSIONS 3

Unit : mm



PACKAGE MARKING

LS05	S05
 <p>R : An initial of "Renesas" 9031 : Part Number N340 : Assembly Lot No.</p> <p>N 3 40 Weekly Serial Code Last one-digit of assembled year Rank Code</p> <p>○ : No.1 pin mark</p>	 <p>9124 : Part Number N231 : Assembly Lot No.</p> <p>N 2 31 Weekly Serial Code Last one-digit of assembled year Rank Code</p> <p>Ⓜ : Pb free Ⓞ : No.1 pin mark An initial of "Renesas" (Carved marking)</p>
LSDIP8	SDIP6
 <p>R : An initial of "Renesas" 9905 : Part Number N131 : Assembly Lot No.</p> <p>N 1 31 Weekly Serial Code Last one-digit of assembled year Rank Code</p> <p>○ : No.1 pin mark</p>	 <p>R : An initial of "Renesas" 9331 : Part Number N320 : Assembly Lot No.</p> <p>N 3 20 Weekly Serial Code Last one-digit of assembled year Rank Code</p> <p>○ : No.1 pin mark</p>
S08	S016
 <p>9817A-1 : Part Number NT131 : Assembly Lot No.</p> <p>N T 1 31 Weekly Serial Code Last one-digit of assembled year Internal Symbol (T:Pb free, Ni/Pd/Au plating on the electrode) Rank Code</p> <p>Ⓞ : No.1 pin mark An initial of "Renesas" (Carved marking)</p>	 <p>R : An initial of "Renesas" 9402 : Part Number NT231 : Assembly Lot No.</p> <p>N T 2 31 Weekly Serial Code Last one-digit of assembled year Internal Symbol (T:Pb free) Rank Code</p> <p>○ : No.1 pin mark</p>
SDIP8	DIP8
 <p>R : An initial of "Renesas" 9332 : Part Number N340 : Assembly Lot No.</p> <p>N 3 04 Weekly Serial Code Last one-digit of assembled year Rank Code</p> <p>○ : No.1 pin mark</p>	 <p>R : An initial of "Renesas" 9531 : Part Number NT331 : Assembly Lot No.</p> <p>N T 3 31 Weekly Serial Code Last one-digit of assembled year Internal Symbol (T:Pb free) Rank Code</p> <p>○ : No.1 pin mark</p>

DIP4 SOP



R : An initial of "Renesas"
 2561D : Part Number as excluding "PS2"
 NR031 : Assembly Lot No.
 N R 0 31
 Weekly Serial Code
 Last one-digit of assembled year
 Internal Symbol
 (R : Assembly in Japan, Y: Assembly in TAIWAN)
 Rank Code
 ○ : No.1 pin mark



R : An initial of "Renesas"
 701A : Part Number as excluding "PS2"
 N301 : Assembly Lot No.
 N 3 01
 Weekly Serial Code
 Last one-digit of assembled year
 Rank Code
 ○ : No.1 pin mark

Assembled Country	TAIWAN	TAIWAN	JAPAN	JAPAN
Halogen Free		○		○
*1, *2: Marking				

SSOP4 SSOP16



R1C : An initial of "Renesas" and Part Number
 R 1C
 Last 2 digits of Part Number (*1)
 *1: When the second digit from bottom of Part Number is "0", only marked last 1 digit.
 An initial of "Renesas"
 301 : Assembly Lot No.
 3 01
 Weekly Serial Code
 Last one-digit of assembled year

Assembled Country	TAIWAN	TAIWAN	JAPAN	JAPAN
Halogen Free		○		○
*2: Marking				



R : An initial of "Renesas"
 PS2801C-4 : Part Number
 NL301 : Assembly Lot No.
 N 3 01
 Weekly Serial Code
 Last one-digit of assembled year
 Internal Symbol
 L: Pb Free
 Rank Code
 ○ : No.1 pin mark
 □ : Assembled Country

LSOP Flat lead



R : An initial of "Renesas"
 2381 : Part Number as excluding "PS"
 N031 : Assembly Lot No.
 N 0 31
 Weekly Serial Code
 Last one-digit of assembled year
 Rank Code
 ○ : No.1 pin mark



R : An initial of "Renesas"
 11 : Part Number as excluding "PS29"
 ex) PS2911 -> 11
 601 : Assembly Lot No.
 6 01
 Weekly Serial Code
 Last one-digit of assembled year
 = : Pb free

SSOP12 LSSOP / LSS05



R : An initial of "Renesas"
 2841A : Part Number as underlined of PA2841-4A
 NL601 : Assembly Lot No.
 N L 6 01
 Weekly Serial Code
 Last one-digit of assembled year
 Internal Symbol
 L: Pb Free
 Rank Code
 ○ : No.1 pin mark



R : An initial of "Renesas"
 2281 : Part Number
 9261 : Part Number
 N744 : Assembly Lot No.
 N 7 44
 Weekly Serial Code
 Last one-digit of assembled year
 Rank Code
 ○ : No.1 pin mark

PACKAGE STRUCTURE 1

Package		LSDIP8	LS05	S05	S016	DIP8 (L4)	SDIP8 (L2)	
Structure								
Package		LSDIP8	LS05	S05	S016	DIP8 (L4)	SDIP8 (L2)	
Air Distance	[mm]	14.5	8	4.2	8	8	8	
Creepage	[mm]	14.5	8	4.2	8	8	8	
Isolation Distance	[mm]	0.4	0.15	0.2	0.4	0.4	0.4	
CTI	[-]	175	400	175	175	175	175	
Isolation Voltage	[Vr.m.s.]	7500	5000	3750	5000	5000	5000	
VIORM	[Vpeak]	1600	1130	707	1130	1130	1130 / 1500 *	
VIOTM	[Vpeak]	12000	8000	6000	8000	8000	8000	
Part Number	VDE (Option)	PS9905 PS9924 PS8902 RV1S9960A	PS9031 PS9009 PS9013 PS9001 RV1S9060A RV1S9061A RV1S9062A	PS9113 PS9151 PS9123 PS9117A PS9124 PS9122 PS8101 RV1S9160A RV1S9161A RV1S9162A	PS9402	PS8551AL4 PS9551AL4	PS8352AL2 * RV1S9353A	

Package		DIP8	DIP8 (L1)	DIP8 (L3)	DIP8 (L2)	SDIP6 (L)	SDIP6 (L2)	SDIP8 (L)	SDIP8 (L2)	S08
Structure										
Package		DIP8	DIP8 (L1)	DIP8 (L3)	DIP8 (L2)	SDIP6 (L)	SDIP6 (L2)	SDIP8 (L)	SDIP8 (L2)	S08
Air Distance	[mm]	7	8	7	8	7	8	7	8	4
Creepage	[mm]	7	8	7	8	7	8	7	8	4
Isolation Distance	[mm]	0.4	0.4	0.4	0.4	0.4	0.4	0.4	0.4	0.2
CTI	[-]	175	175	175	175	175	175	175	175	175
Isolation Voltage	[Vr.m.s.]	5000	5000	5000	5000	5000	5000	5000	5000	2500
VIORM	[Vpeak]	1130	1130	1130	1130	1130	1130	1130	1130	566
VIOTM	[Vpeak]	8000	8000	8000	8000	8000	8000	8000	8000	4000
Part Number	VDE (Option)	PS9531 PS9506 PS9513 PS9587 PS8501 PS8502	PS9531L1 PS9506L1 PS9513L1 PS9587L1 PS8501L1 PS8502L1	PS9531L3 PS9506L3 PS9513L3 PS9587L3 PS8501L3 PS8502L3	PS9531L2 PS9506L2 PS9513L2 PS9587L2 PS8501L2 PS8502L2	PS9307AL PS9331L PS9317L PS9313L PS9303L PS9309L PS9351L PS9324L PS8302L	PS9307AL2 PS9331L2 PS9317L2 PS9313L2 PS9303L2 PS9309L2 PS9351L2 PS9324L2 PS8302L2	PS9332L	PS9332L2	PS9817A-1 PS9817A-2 PS9851-1 PS9851-2 PS9821-1 PS9821-2 PS9822-1 PS9822-2

Package		DIP4			DIP4 (L1)		DIP4 (L)			DIP4 (L2)		LSOP	
Structure													
Package		DIP4			DIP4 (L1)		DIP4 (L)			DIP4 (L2)		LSOP	
Air Distance	[mm]	7	7	7	8	7	7	7	7	8	7	8	
Creepage	[mm]	7	7	7	8	7	7	7	7	8	7	8	
Isolation Distance	[mm]	0.4	0.3	0.3	0.4	0.4	0.4	0.3	0.3	0.4	0.4	0.4	
CTI	[-]	175	175	175	175	175	175	175	175	175	175	175	
Isolation Voltage	[Vr.m.s.]	5000	5000	5000	5000	5000	5000	5000	5000	5000	5000	5000	
VIORM	[Vpeak]	890	890	—	1130	890	890	890	—	1130	890	1130	
VIOTM	[Vpeak]	8000	8000	—	8000	8000	8000	8000	—	8000	8000	8000	
Part Number	VDE (Option)	PS2561D-1 PS2533-1 PS2535-1 PS2565-1	PS2514-1		PS2561DL1-1	PS2562L1-1 PS2565L1-1	PS2561DL-1 PS2533L-1 PS2535L-1 PS2565L-1	PS2514L-1		PS2561DL2-1	PS2562L2-1 PS2565L2-1	PS2381-1	
	No VDE Option	PS2561F-1		PS2506-1			PS2561FL-1		PS2506L-1				

Package		SOP			SSOP4		SSOP16	SSOP12		Flat lead	
Structure											
Package		SOP			SSOP4		SSOP16	SSOP12		Flat lead	
Air Distance	[mm]	5	5	5	4.5	5	4.5	4		4	
Creepage	[mm]	5	5	5	4.5	5	4.5	4		4	
Isolation Distance	[mm]	0.3	0.3	0.4	0.1	0.4	0.1	0.4		0.4	
CTI	[-]	175	175	175	175	175	175	175		175	
Isolation Voltage	[Vr.m.s.]	3750	2500	3750	2500	3750	2500	1500		2500	
VIORM	[Vpeak]	707	707	707	705	710	705	—		570	
VIOTM	[Vpeak]	6000	4000	6000	6000	6000	6000	—		4000	
Part Number	VDE (Option)	PS2701A-1 PS2703-1 PS2702-1 PS2705A-1 PS2706-1 PS2711-1 PS2715-1	PS2733-1	PS2761B-1	PS2801C-1 PS2811-1 PS2833-1 PS2802-1 PS2805C-1 PS2815C-1	PS2861B-1	PS2801C-4 PS2811-4 PS2833-4 PS2802-4 PS2805C-4 PS2815C-4			PS2911-1 PS2913-1 PS2915-1 PS2933-1	
	No VDE Option							PS2841-4A PS2841-4B PS2845-4A			

Internal Structure is a reference image

PACKAGE STRUCTURE 2

Package		LSS05	LSS0P
Structure			
Package		LSS05	LSS0P
Air Distance	[mm]	8.2	8.2
Creepage	[mm]	8.2	8.2
Isolation Distance	[mm]	0.15	0.15
CTI	[-]	400	400
Isolation Voltage	[Vr.m.s.]	5000	5000
VIORM	[Vpeak]	1075	1100
VIORM	[Vpeak]	8000	8000
Part Number	VDE (Option)	RV1S9207A RV1S9209A RV1S9213A RV1S9231A RV1S9260A RV1S9261A RV1S9262A	RV1S2211A RV1S2281A RV1S2285A

SAFETY STANDARD APPROVAL LIST 1

Visit our website.



1. ●: certified, R: reinforced insulation, S: supplementary insulation, B: basic insulation
 2. A special ordering number is required for VDE-conformant products.

<https://www.renesas.com/products/interface-connectivity/optoelectronics/photocouplers-optocouplers-safety-standards-classification-chart-ul-csa-bsi-vde-approval>

Part Number	Safety Standards									
	UL				CSA		BSI		VDE	
	UL1577 Single/Double Protection				CAN/CSA C22.2 62368-1 IEC 62368-1		BS EN 62368-1		DIN EN 60747-5-5 DIN EN IEC 60747-5-5	
	Single	Double	Assembly in JAPAN	Assembly in TAIWAN	Assembly in JAPAN	Assembly in TAIWAN	Assembly in JAPAN	Assembly in TAIWAN	Assembly in JAPAN	Assembly in TAIWAN
RV1S2211A	●	●	●	—	●R	—	—	—	●	—
RV1S2281A	●	●	●	—	●R	—	—	—	●	—
RV1S2285A	●	●	●	—	●R	—	—	—	●	—
PS2381-1	●	●	●	—	●R	—	—	—	●	—
PS2506-1, PS2506L-1	●	●	●	—	—	—	—	—	—	—
PS2514-1, PS2514L-1	●	●	●	●	●B/R	●B/R	—	—	●	●
PS2533-1, PS2533L-1	●	●	●	—	●R	—	●R	—	●	—
PS2535-1, PS2535L-1	●	●	●	—	—	—	●R	—	●	—
PS2561D-1, PS2561DL-1 PS2561DL1-1, PS2561DL2-1	●	●	●	●	●R	●R	●R	●R	●	●
PS2561F-1, PS2561FL-1	●	●	●	●	—	—	—	—	—	—
PS2562-1, PS2562L-1 PS2562L1-1, PS2562L2-1	●	●	●	—	●R	—	●R	—	●	—
PS2565-1, PS2565L-1 PS2565L1-1, PS2565L2-1	●	●	●	●	●R	●R	●R	●R	●	●
PS2701A-1	●	—	●	●	●B/S	●B/S	●B/S	●B/S	●	●
PS2702-1	●	—	●	●	●B/S	●B/S	●B/S	●B/S	●	●
PS2703-1	●	—	●	●	●B/S	●B/S	●B/S	●B/S	●	●
PS2705A-1	●	—	●	●	●B/S	●B/S	—	—	●	●
PS2706-1	●	—	●	—	●B/S	—	●B/S	—	●	—
PS2711-1	●	—	●	—	●B/S	—	—	—	●	—
PS2715-1	●	—	●	—	●B/S	—	—	—	●	—
PS2733-1	●	—	●	—	●B/S	—	●B/S	—	●	—
PS2761B-1	●	●	●	●	●R	●R	●R	●R	●	●
PS2801C-1	●	—	●	●	●B	●B	●B/S	●B/S	●	●
PS2801C-4	●	—	●	—	●B	—	—	—	●	—
PS2802-1, -4	●	—	●	—	●B	—	●B/S	—	●	—
PS2805C-1	●	—	●	●	●B	●B	●B/S	●B/S	●	●
PS2805C-4	●	—	●	—	●B	—	—	—	●	—
PS2811-1	●	—	●	●	●B	●B	—	—	●	●
PS2811-4	●	—	●	—	●B	—	—	—	●	—
PS2815-1	●	—	●	●	●B	●B	—	—	●	●
PS2815-4	●	—	●	—	●B	—	—	—	●	—
PS2833-1	●	—	●	—	●B	—	—	—	●	—
PS2833-4	●	—	●	—	●B	—	—	—	●	—
PS2841-4A, -4B	●	—	●	—	—	—	—	—	—	—
PS2845-4A	●	—	●	—	—	—	—	—	—	—
PS2861B-1	●	—	●	●	●R	●R	●R	●R	●	●
PS2911-1	●	—	●	—	—	—	●S	—	●	—
PS2913-1	●	—	●	—	—	—	●S	—	●	—
PS2915-1	●	—	●	—	—	—	●S	—	●	—
PS2933-1	●	—	●	—	—	—	●S	—	●	—
PS8101	●	—	●	—	●B	—	—	—	●	—
PS8302L, PS8302L2	●	●	●	—	●R	—	—	—	●	—
PS8352AL2	●	●	●	—	●R	—	—	—	●	—

SAFETY STANDARD APPROVAL LIST 2

1. ●: certified, R: reinforced insulation, S: supplementary insulation, B: basic insulation

2. A special ordering number is required for VDE-conformant products.

Part Number	Safety Standards									
	UL				CSA		BSI		VDE	
	UL1577 Single/Double Protection				CAN/CSA C22.2 62368-1 IEC 62368-1		BS EN 62368-1		DIN EN 60747-5-5 DIN IEC 60747-5-5	
	Single	Double	Assembly in JAPAN	Assembly in TAIWAN	Assembly in JAPAN	Assembly in TAIWAN	Assembly in JAPAN	Assembly in TAIWAN	Assembly in JAPAN	Assembly in TAIWAN
PS8501, PS8501L1 PS8501L2, PS8501L3	●	●	●	—	●R	—	●R	—	●	—
PS8502, PS8502L1 PS8502L2, PS8502L3	●	●	●	—	●R	—	●R	—	●	—
PS8551AL4	●	●	●	—	●R	—	—	—	●	—
PS8802-1, -2	●	—	●	—	●B	—	—	—	●	—
PS8902	●	●	●	—	●R	—	—	—	●	—
PS9001	●	●	●	—	●R	—	—	—	●	—
PS9009	●	●	●	—	●R	—	—	—	●	—
PS9013	●	●	●	—	●R	—	—	—	●	—
PS9031	●	●	●	—	●R	—	—	—	●	—
RV1S9060A	●	●	●	—	●R	—	—	—	●	—
RV1S9061A	●	●	●	—	●R	—	—	—	●	—
RV1S9062A	●	●	●	—	●R	—	—	—	●	—
PS9113	●	—	●	—	●B	—	—	—	●	—
PS9117A	●	—	●	—	●B	—	—	—	●	—
PS9122	●	—	●	—	—	—	—	—	●	—
PS9123	●	—	●	—	●B	—	—	—	●	—
PS9124	●	—	●	—	●B	—	—	—	●	—
PS9151	●	—	●	—	—	—	—	—	●	—
RV1S9160A	●	●	●	—	●B	—	—	—	●	—
RV1S9161A	●	●	●	—	●B	—	—	—	●	—
RV1S9162A	●	●	●	—	●B	—	—	—	●	—
RV1S9207A	●	●	●	—	●R	—	—	—	●	—
RV1S9209A	●	●	●	—	●R	—	—	—	●	—
RV1S9213A	●	●	●	—	●R	—	—	—	●	—
RV1S9231A	●	●	●	—	●R	—	—	—	●	—
RV1S9260A	●	●	●	—	●R	—	—	—	●	—
RV1S9261A	●	●	●	—	●R	—	—	—	●	—
RV1S9262A	●	●	●	—	●R	—	—	—	●	—
PS9303L, PS9303L2	●	●	●	—	●R	—	—	—	●	—
PS9307AL, PS9307AL2	●	●	●	—	●R	—	—	—	●	—
PS9309L, PS9309L2	●	●	●	—	●R	—	—	—	●	—
PS9313L, PS9313L2	●	●	●	—	●R	—	—	—	●	—
PS9317L, PS9317L2	●	●	●	—	●R	—	—	—	●	—
PS9324L, PS9324L2	●	●	●	—	●R	—	—	—	●	—
PS9331L, PS9331L2	●	●	●	—	●R	—	—	—	●	—
PS9332L, PS9332L2	●	●	●	—	●R	—	—	—	●	—
PS9351L, PS9351L2	●	●	●	—	●R	—	—	—	●	—
PS9352AL2	●	●	●	—	●R	—	—	—	●	—
RV1S9353A	●	●	●	—	●R	—	—	—	●	—
PS9402	●	●	●	—	●R	—	—	—	●	—
PS9506, PS9506L1 PS9506L2, PS9506L3	●	●	●	—	●R	—	—	—	●	—
PS9513, PS9513L1 PS9513L2, PS9513L3	●	●	●	—	●R	—	●R	—	●	—

SAFETY STANDARD APPROVAL LIST 3

Visit our website.

<https://www.renesas.com/products/interface-connectivity/optoelectronics/photocouplers-optocouplers-safety-standards-classification-chart-ul-csa-bsi-vde-approval>

Part Number	Safety Standards									
	UL				CSA		BSI		VDE	
	UL1577 Single/Double Protection				CAN/CSA C22.2 62368-1 IEC 62368-1		BS EN 62368-1		DIN EN 60747-5-5 DIN EN IEC 60747-5-5	
	Single	Double	Assembly in JAPAN	Assembly in TAIWAN	Assembly in JAPAN	Assembly in TAIWAN	Assembly in JAPAN	Assembly in TAIWAN	Assembly in JAPAN	Assembly in TAIWAN
PS9531, PS9531L1 PS9531L2, PS9531L3	•	•	•	–	•R	–	–	–	•	–
PS9551AL4	•	•	•	–	•R	–	–	–	•	–
PS9587, PS9587L1 PS9587L2, PS9587L3	•	•	•	–	•R	–	•R	–	•	–
PS9817A-1, -2	•	–	•	–	•B	–	–	–	•	–
PS9821-1, -2	•	–	•	–	•B	–	–	–	•	–
PS9822-1, -2	•	–	•	–	–	–	–	–	•	–
PS9851-1, -2	•	–	•	–	–	–	–	–	•	–
PS9905	•	•	•	–	•R	–	–	–	•	–
PS9924	•	•	•	–	•R	–	–	–	•	–
RV1S9960A	•	•	•	–	•R	–	–	–	•	–

RECOMMENDED LAND PATTERN

Unit : mm

LS05	DIP4 (L)	SDIP6
<p>Diagram showing the recommended land pattern for LS05 package. Dimensions include 1.27, 0.8, 1.3, 9.5, and 2.54 mm.</p>	<p>Diagram showing the recommended land pattern for DIP4 (L) package. Dimensions include 1.7, 2.2, 8.2, and 2.54 mm.</p>	<p>Diagram showing the recommended land pattern for SDIP6 package. Dimensions include 1.27, 0.8, 2.2, and 9.2 mm.</p>
LSDIP8	DIP4 (L2)	SDIP6 (L2)
<p>Diagram showing the recommended land pattern for LSDIP8 package. Dimensions include 1.27, 0.9, 2, and 16.6 mm.</p>	<p>Diagram showing the recommended land pattern for DIP4 (L2) package. Dimensions include 1.7, 2.2, 10.2, and 2.54 mm.</p>	<p>Diagram showing the recommended land pattern for SDIP6 (L2) package. Dimensions include 1.27, 0.8, 2.2, and 10.2 mm.</p>
S016	DIP8 (L3)	SDIP8 (L)
<p>Diagram showing the recommended land pattern for S016 package. Dimensions include 1.27, 0.96, 1.65, and 9.85 mm.</p>	<p>Diagram showing the recommended land pattern for DIP8 (L3) package. Dimensions include 2.54, 1.7, 2.0, and 9.0 mm.</p>	<p>Diagram showing the recommended land pattern for SDIP8 (L) package. Dimensions include 1.27, 0.8, 2.2, and 9.2 mm.</p>
DIP8 (L4)	DIP8 (L2)	SDIP8 (L2)
<p>Diagram showing the recommended land pattern for DIP8 (L4) package. Dimensions include 2.54, 1.7, 2.0, and 9.0 mm.</p>	<p>Diagram showing the recommended land pattern for DIP8 (L2) package. Dimensions include 2.54, 1.7, 2.2, and 10.2 mm.</p>	<p>Diagram showing the recommended land pattern for SDIP8 (L2) package. Dimensions include 1.27, 0.8, 2.2, and 10.2 mm.</p>

Unit : mm

S05	SSOP4	LSS05
<p>1.27 0.8 1.45 6.25 2.54</p>	<p>0.8 1.45 6.25 1.27</p>	<p>0.65 0.35 1.3 9.5 1.3 0.4</p>
S08	SSOP16	LSSOP
<p>1.27 0.8 1.45 5.25</p>	<p>1.27 0.8 1.45 6.25</p>	<p>0.4 1.3 9.5 1.3</p>
SOP	SSOP12	
<p>0.8 1.45 6.25 2.54</p>	<p>0.80 0.5 1.45 6.25</p>	
LSOP	Flat lead	
<p>0.8 1.3 9.5 2.54</p>	<p>0.8 0.6 1.27 0.35 4.14 1.3 5.7 24-R0.1</p>	

TAPING & REEL SPECIFICATIONS



Direction of Product Inserted in Tape



LS05	S05	S08	S016
LSDIP	SDIP6 (L,L2)	SDIP8 (L,L2)	DIP8 (L2,L3,L4)
DIP (L,L2)	SOP	LSOP	Flat lead
SSOP4	SSOP16	SSOP12	LSS05 / LSSOP

Reel Dimensions					
Symbol	Unit	Tape Width (W)			
		12 mm	16 mm	16 mm	24 mm
A	mm	Ø330±2.0	Ø330±2.0	Ø330±2.0	Ø330±2.0
W1	mm	13.4±1.0	17.4±1.0	17.4±1.0	25.4±1.0
W2	mm	17.4±1.0	21.4±1.0	21.4±1.0	29.4±1.0
B	mm	Ø100±1.0	Ø100±1.0	Ø80±1.0	Ø100±1.0
C	mm	Ø13.0±0.2	Ø13.0±0.2	Ø13.0±0.2	Ø13.0±0.2
D	mm	Ø21.0±0.8	Ø21.0±0.8	Ø21.0±0.8	Ø21.0±0.8
E	mm	2.0±0.5	2.0±0.5	2.0±0.5	2.0±0.5
Package (IC output coupler)		S05	DIP8 (L3)		DIP8 (L2)
		S08	DIP8 (L4)		SDIP6 (L2)
			SDIP6 (L)		SDIP8 (L2)
			SDIP8 (L)		LSDIP8
			LS05		SO16
Package (Tr. output coupler)		SOP	DIP4 (L)		DIP4 (L2)
		Flat leads	LSOP		
			LSSOP		
		SSOP12	SSOP4	SSOP16	

Tape Dimensions (IC Output Coupler)														
Symbol	Unit	S05	S08	DIP8 (L3)	DIP8 (L4)	SDIP6 (L)	SDIP8 (L)	LS05	LSS05	DIP8 (L2)	SDIP6 (L2)	SDIP8 (L2)	LSDIP8	SO16
A0	mm	3.9±0.1	6.4±0.1	10.3±0.1	9.95±0.1	5.08±0.1	6.35±0.1	4.3±0.1	2.85±0.1	10.4±0.1	5.08±0.1	6.35±0.1	7.2±0.1	10.9±0.1
B0	mm	7.4±0.1	5.56±0.1	10.4±0.1	10.55±0.1	10.2±0.1	10.2±0.1	10.7±0.1	10.7±0.1	12.5±0.1	12.0±0.1	12.0±0.1	17.2±0.1	10.8±0.1
K0	mm	3.0±0.1	3.6±0.1	4.75±0.1	4.2±0.1	4.05±0.1	4.05±0.1	2.3±0.1	2.1±0.1	4.1±0.1	4.05±0.1	4.05±0.1	4.05±0.1	3.8±0.1
P1	mm	8.0±0.1	8.0±0.1	12.0±0.1	12.0±0.1	8.0±0.1	8.0±0.1	8.0±0.1	4.0±0.1	12.0±0.1	8.0±0.1	8.0±0.1	12.0±0.1	16.0±0.1
D1	mm	Ø1.55±0.1	Ø1.7±0.1	Ø1.55±0.1	Ø1.55±0.1	Ø1.55±0.1	Ø1.55±0.1	Ø1.55±0.1	Ø1.55±0.1	Ø2.05±0.05	Ø2.05±0.1	Ø2.05±0.1	Ø2.0±0.2	Ø1.55±0.1
J	mm	Ø1.5+0.1/-0	Ø1.5+0.1/-0	Ø1.5+0.1/-0	Ø1.5+0.1/-0	Ø1.5+0.1/-0	Ø1.5+0.1/-0	Ø1.5+0.1/-0	Ø1.5+0.1/-0	Ø1.5+0.1/-0	Ø1.5+0.1/-0	Ø1.5+0.1/-0	Ø1.5+0.1/-0	Ø1.5+0.1/-0
H	mm	4.0±0.1	4.0±0.1	4.0±0.1	4.0±0.1	4.0±0.1	4.0±0.1	4.0±0.1	4.0±0.1	4.0±0.1	4.0±0.1	4.0±0.1	4.0±0.1	4.0±0.1
E	mm	1.75±0.1	1.75±0.1	1.75±0.1	1.75±0.1	1.75±0.1	1.75±0.1	1.75±0.1	1.75±0.1	1.75±0.1	1.75±0.1	1.75±0.1	1.75±0.1	1.75±0.1
G	mm	2.0±0.05	2.0±0.05	2.0±0.1	2.0±0.1	2.0±0.1	2.0±0.1	2.0±0.1	2.0±0.1	2.0±0.1	2.0±0.1	2.0±0.1	2.0±0.1	2.0±0.1
F	mm	5.5±0.1	5.5±0.1	7.5±0.1	7.5±0.1	7.5±0.1	7.5±0.1	7.5±0.1	7.5±0.1	11.5±0.1	11.5±0.1	11.5±0.1	11.5±0.1	11.5±0.1
W	mm	12.0±0.2	12.0±0.2	16.0±0.3	16.0±0.3	16.0±0.3	16.0±0.3	16.0±0.3	16.0±0.3	24.0±0.3	24.0±0.3	24.0±0.3	24.0±0.3	24.0±0.3
t	mm	0.3±0.05	0.3	0.35	0.3	0.35	0.35	0.3	0.3	0.3±0.05	0.35	0.35	0.35	0.4
x	pcs	2500	1500	1000	1000	2000	2000	3000	3500	1000	2000	2000	1000	850

Tape Dimensions (Tr. Output Coupler)										
Symbol	Unit	SOP	Flat Leads	SSOP12	DIP4 (L)	LSOP	LSSOP	SSOP4	SSOP16	DIP4 (L2)
A0	mm	4.4±0.1	2.9±0.1	6.0±0.1	5.3±0.1	4.3±0.1	2.85±0.1	2.85±0.1	8.3±0.1	5.3±0.1
B0	mm	7.4±0.1	5.3±0.1	7.4±0.1	10.3±0.1	10.7±0.1	10.7±0.1	7.55±0.1	10.7±0.1	12.5±0.1
K0	mm	2.4±0.1	2.4±0.1	2.85±0.1	4.0±0.1	2.3±0.1	2.1±0.1	2.3±0.1	2.3±0.1	4.05±0.1
P1	mm	8.0±0.1	4.0±0.1	8.0±0.1	8.0±0.1	8.0±0.1	4.0±0.1	4.0±0.1	12.0±0.1	8.0±0.1
D1	mm	Ø1.55±0.1	Ø1.55±0.05	Ø1.55±0.1	Ø1.55±0.1	Ø1.55±0.1	Ø1.55±0.1	Ø1.55±0.1	Ø1.55±0.1	Ø2.05±0.1
J	mm	Ø1.5+0.1/-0	Ø1.5+0.1/-0	Ø1.5+0.1/-0	Ø1.5+0.1/-0	Ø1.5+0.1/-0	Ø1.5+0.1/-0	Ø1.5+0.1/-0	Ø1.5+0.1/-0	Ø1.5+0.1/-0
H	mm	4.0±0.1	4.0±0.1	4.0±0.1	4.0±0.1	4.0±0.1	4.0±0.1	4.0±0.1	4.0±0.1	4.0±0.1
E	mm	1.75±0.1	1.75±0.1	1.75±0.1	1.75±0.1	1.75±0.1	1.75±0.1	1.75±0.1	1.75±0.1	1.75±0.1
G	mm	2.0±0.05	2.0±0.05	2.0±0.05	2.0±0.1	2.0±0.1	2.0±0.1	2.0±0.1	2.0±0.1	2.0±0.1
F	mm	5.5±0.05	5.5±0.05	5.5±0.1	7.5±0.1	7.5±0.1	7.5±0.1	7.5±0.1	7.5±0.1	11.5±0.1
W	mm	12.0±0.2	12.0±0.2	12.0±0.2	16.0±0.3	16.0±0.3	16.0±0.3	16.0±0.3	16.0±0.3	24.0±0.3
t	mm	0.3	0.3	0.3	0.4	0.3	0.3	0.3	0.25	0.4
x	pcs	3500	3500	2500	2000	3000	3500	3500	2500	1000

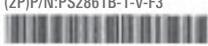
LABEL PRINT EXAMPLES

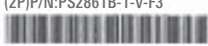
OUTER PACKING BOX	REAL
 <p style="text-align: center;">LABEL</p>	 <p style="text-align: center;">LABEL</p>
LABEL on OUTER PACKING BOX	LABEL on TAPING REEL
<p>Assembly in JAPAN</p> <p style="text-align: right;">Marking of Safety Standards</p>  <p>Pb-Free T. RENESAS</p> <p>D/N PS2861B1YVF3A/0118B/R2 MC:JPJP SPN PS2861B-1Y-V-F3-A 002G116NR2 MADE IN JAPAN CTR rank</p> <hr/> <p>PN PS2861B-1-V-F3 2014/01/10 PID 124446105V-001 QTY 7000 Quantity (ex. 2reels) PCD 0000184865 T/C 1402 123QA4567 S.LOT YL2209K801</p> 	<p>Assembly in JAPAN</p>  <p>Pb-Free T. RENESAS MC:JPJP L-179V2 (S)BOX ID:L2K9005FB</p> <p>(2P)P/N:PS2861B-1-V-F3 (P)INTP:PS2861B-1Y-V-F3-A (1P)INTS:PS2861B-1Y-V-F3-A Z/S/NO:NR2 (Q)QTY:3500 CTR rank Quantity (1T)LOT:123QA4567</p>    <p style="text-align: right;">Marking of Safety Standards</p>
<p>Assembly in TAIWAN</p> <p style="text-align: right;">Marking of Safety Standards</p>  <p>Pb-Free T. RENESAS</p> <p>D/N PS2861B1YVF3A/0118B/R2 MC:JPTWTW SPN PS2861B-1Y-V-F3-A 002G116NR2 ASSEMBLED IN TAIWAN FROM WAFERS OF JAPAN CTR rank</p> <hr/> <p>PN PS2861B-1-V-F3 2014/01/10 PID 124446105V-001 QTY 7000 Quantity (ex. 2reels) PCD 0000184865 T/C 1402 123WB4567 S.LOT YL2209K801</p> 	<p>Assembly in TAIWAN</p>  <p>Pb-Free T. RENESAS MC:JPJP L-179V2 (S)BOX ID:L2K9005FB</p> <p>(2P)P/N:PS2861B-1-V-F3 (P)INTP:PS2861B-1Y-V-F3-A (1P)INTS:PS2861B-1Y-V-F3-A Z/S/NO:NY2 (Q)QTY:3500 CTR rank Quantity (1T)LOT:123QA4567</p>    <p style="text-align: right;">Marking of Safety Standards</p>

PART NUMBER GUIDE

Part number guide = P/N starting with "RV1S" =



*) P/N with "Q" at "Version" indicates products for automotive use. In this case, there are digits that do not follow the definition on this page.

Part number guide = P/N starting with "PS" =



Notice

1. Descriptions of circuits, software and other related information in this document are provided only to illustrate the operation of semiconductor products and application examples. You are fully responsible for the incorporation or any other use of the circuits, software, and information in the design of your product or system. Renesas Electronics disclaims any and all liability for any losses and damages incurred by you or third parties arising from the use of these circuits, software, or information.
 2. Renesas Electronics hereby expressly disclaims any warranties against and liability for infringement or any other claims involving patents, copyrights, or other intellectual property rights of third parties, by or arising from the use of Renesas Electronics products or technical information described in this document, including but not limited to, the product data, drawings, charts, programs, algorithms, and application examples.
 3. No license, express, implied or otherwise, is granted hereby under any patents, copyrights or other intellectual property rights of Renesas Electronics or others.
 4. You shall be responsible for determining what licenses are required from any third parties, and obtaining such licenses for the lawful import, export, manufacture, sales, utilization, distribution or other disposal of any products incorporating Renesas Electronics products, if required.
 5. You shall not alter, modify, copy, or reverse engineer any Renesas Electronics product, whether in whole or in part. Renesas Electronics disclaims any and all liability for any losses or damages incurred by you or third parties arising from such alteration, modification, copying or reverse engineering.
 6. Renesas Electronics products are classified according to the following two quality grades: "Standard" and "High Quality". The intended applications for each Renesas Electronics product depends on the product's quality grade, as indicated below.
 - "Standard": Computers; office equipment; communications equipment; test and measurement equipment; audio and visual equipment; home electronic appliances; machine tools; personal electronic equipment; industrial robots; etc.
 - "High Quality": Transportation equipment (automobiles, trains, ships, etc.); traffic control (traffic lights); large-scale communication equipment; key financial terminal systems; safety control equipment; etc.
 Unless expressly designated as a high reliability product or a product for harsh environments in a Renesas Electronics data sheet or other Renesas Electronics document, Renesas Electronics products are not intended or authorized for use in products or systems that may pose a direct threat to human life or bodily injury (artificial life support devices or systems; surgical implantations; etc.), or may cause serious property damage (space system; undersea repeaters; nuclear power control systems; aircraft control systems; key plant systems; military equipment; etc.). Renesas Electronics disclaims any and all liability for any damages or losses incurred by you or any third parties arising from the use of any Renesas Electronics product that is inconsistent with any Renesas Electronics data sheet, user's manual or other Renesas Electronics document.
 7. No semiconductor product is absolutely secure. Notwithstanding any security measures or features that may be implemented in Renesas Electronics hardware or software products, Renesas Electronics shall have absolutely no liability arising out of any vulnerability or security breach, including but not limited to any unauthorized access to or use of a Renesas Electronics product or a system that uses a Renesas Electronics product. RENESAS ELECTRONICS DOES NOT WARRANT OR GUARANTEE THAT RENESAS ELECTRONICS PRODUCTS, OR ANY SYSTEMS CREATED USING RENESAS ELECTRONICS PRODUCTS WILL BE INVULNERABLE OR FREE FROM CORRUPTION, ATTACK, VIRUSES, INTERFERENCE, HACKING, DATA LOSS OR THEFT, OR OTHER SECURITY INTRUSION ("Vulnerability Issues"). RENESAS ELECTRONICS DISCLAIMS ANY AND ALL RESPONSIBILITY OR LIABILITY ARISING FROM OR RELATED TO ANY VULNERABILITY ISSUES. FURTHERMORE, TO THE EXTENT PERMITTED BY APPLICABLE LAW, RENESAS ELECTRONICS DISCLAIMS ANY AND ALL WARRANTIES, EXPRESS OR IMPLIED, WITH RESPECT TO THIS DOCUMENT AND ANY RELATED OR ACCOMPANYING SOFTWARE OR HARDWARE, INCLUDING BUT NOT LIMITED TO THE IMPLIED WARRANTIES OF MERCHANTABILITY, OR FITNESS FOR A PARTICULAR PURPOSE.
 8. When using Renesas Electronics products, refer to the latest product information (data sheets, user's manuals, application notes, "General Notes for Handling and Using Semiconductor Devices" in the reliability handbook, etc.), and ensure that usage conditions are within the ranges specified by Renesas Electronics with respect to maximum ratings, operating power supply voltage range, heat dissipation characteristics, installation, etc. Renesas Electronics disclaims any and all liability for any malfunctions, failure or accident arising out of the use of Renesas Electronics products outside of such specified ranges.
 9. Although Renesas Electronics endeavors to improve the quality and reliability of Renesas Electronics products, semiconductor products have specific characteristics, such as the occurrence of failure at a certain rate and malfunctions under certain use conditions. Unless designated as a high reliability product or a product for harsh environments in a Renesas Electronics data sheet or other Renesas Electronics document, Renesas Electronics products are not subject to radiation resistance design. You are responsible for implementing safety measures to guard against the possibility of bodily injury, injury or damage caused by fire, and/or danger to the public in the event of a failure or malfunction of Renesas Electronics products, such as safety design for hardware and software, including but not limited to redundancy, fire control and malfunction prevention, appropriate treatment for aging degradation or any other appropriate measures. Because the evaluation of microcomputer software alone is very difficult and impractical, you are responsible for evaluating the safety of the final products or systems manufactured by you.
 10. Please contact a Renesas Electronics sales office for details as to environmental matters such as the environmental compatibility of each Renesas Electronics product. You are responsible for carefully and sufficiently investigating applicable laws and regulations that regulate the inclusion or use of controlled substances, including without limitation, the EU RoHS Directive, and using Renesas Electronics products in compliance with all these applicable laws and regulations. Renesas Electronics disclaims any and all liability for damages or losses occurring as a result of your noncompliance with applicable laws and regulations.
 11. Renesas Electronics products and technologies shall not be used for or incorporated into any products or systems whose manufacture, use, or sale is prohibited under any applicable domestic or foreign laws or regulations. You shall comply with any applicable export control laws and regulations promulgated and administered by the governments of any countries asserting jurisdiction over the parties or transactions.
 12. It is the responsibility of the buyer or distributor of Renesas Electronics products, or any other party who distributes, disposes of, or otherwise sells or transfers the product to a third party, to notify such third party in advance of the contents and conditions set forth in this document.
 13. This document shall not be reprinted, reproduced or duplicated in any form, in whole or in part, without prior written consent of Renesas Electronics.
 14. Please contact a Renesas Electronics sales office if you have any questions regarding the information contained in this document or Renesas Electronics products.
- (Note 1) "Renesas Electronics" as used in this document means Renesas Electronics Corporation and also includes its directly or indirectly controlled subsidiaries.
- (Note 2) "Renesas Electronics product(s)" means any product developed or manufactured by or for Renesas Electronics.

(Rev.5.0-1 October 2020)

SALES OFFICES

Refer to "http://www.renesas.com/" for the latest and detailed information.

Renesas Electronics Corporation

TOYOSU FORESIA, 3-2-24 Toyosu, Koto-ku, Tokyo 135-0061, Japan

Renesas Electronics America Inc. Milpitas Campus

1001 Murphy Ranch Road, Milpitas, CA 95035, U.S.A.
Tel: +1-408-432-8888, Fax: +1-408-434-5351

Renesas Electronics America Inc. San Jose Campus

6024 Silver Creek Valley Road, San Jose, CA 95138, USA
Tel: +1-408-284-8200, Fax: +1-408-284-2775

Renesas Electronics Canada Limited

603 March Road, Ottawa, ON K2K 2M5, Canada
Tel: +1-613-595-6300, Fax: +1-613-595-6329

Renesas Electronics Europe GmbH

Arcadiastrasse 10, 40472 Düsseldorf, Germany
Tel: +49-211-6503-0, Fax: +49-211-6503-1327

Renesas Electronics (China) Co., Ltd.

Room 101-T01, Floor 1, Building 7, Yard No. 7, 8th Street, Shangdi, Haidian District, Beijing 100085, China
Tel: +86-10-8235-1155, Fax: +86-10-8235-7679

Renesas Electronics (Shanghai) Co., Ltd.

Unit 301, Tower A, Central Towers, 555 Langao Road, Putuo District, Shanghai 200333, China
Tel: +86-21-2226-0888, Fax: +86-21-2226-0999

Renesas Electronics Hong Kong Limited

Unit 3501-03, 35/F, One Kowloon, 1 Wang Yuen Street, Kowloon Bay, Hong Kong
Tel: +852-2265-6688, Fax: +852-2886-9022

Renesas Electronics Taiwan Co., Ltd.

13F, No. 363, Fu Shing North Road, Taipei 10543, Taiwan
Tel: +886-2-8175-9600, Fax: +886-2-8175-9670

Renesas Electronics Singapore Pte. Ltd.

80 Bendemeer Road, #06-02 Singapore 339949
Tel: +65-6213-0200, Fax: +65-6213-0300

Renesas Electronics Malaysia Sdn.Bhd.

Unit No 3A-1 Level 3A Tower 8 UOA Business Park, No 1 Jalan Pengaturcara U1/51A, Seksyen U1, 40150 Shah Alam, Selangor, Malaysia
Tel: +60-3-5022-1288, Fax: +60-3-5022-1290

Renesas Electronics India Pvt. Ltd.



Bagmane Tech Park, Municipal No. 66/1-4, Lakeview Block, Block B, Ground Floor, Krishnappa Garden, CV Raman Nagar, Bengaluru, Karnataka 560 093, India
Tel: +91-80-67208700

Renesas Electronics Korea Co., Ltd.

7F, Hae-seong 2nd building, 508, Teheran-ro, Gangnam-gu, Seoul, Korea 06178
Tel: +82-2-558-3737, Fax: +82-2-558-5338

Looking for pricing, stock, or lifecycle information?

Click below to explore more details on WIN SOURCE:

-  [View PS2525-1-A on WIN SOURCE](#)
-  [CEL Information](#)

Optimize Your Supply Chain with WIN SOURCE Solutions

-  Global Sourcing Solution
-  Obsolete Management
-  Cost Control Management
-  Shortage Management
-  Alternative Solution
-  Excess Inventory Management