



**THE DATASHEET OF  
CY7C1370DV25-167AXC**





**THIS SPEC IS OBSOLETE**

**Spec No:** 38-05558

**Spec Title:** CY7C1370DV25/CY7C1372DV25, 18-MBIT  
(512K X 36/1M X 18) PIPELINED SRAM WITH  
NOBL(TM) ARCHITECTURE

**Replaced by:** NONE

# 18-Mbit (512K × 36/1M × 18) Pipelined SRAM with NoBL™ Architecture

## Features

- Pin-compatible and functionally equivalent to ZBT™
- Supports 200-MHz bus operations with zero wait states
  - Available speed grades are 200 and 167 MHz
- Internally self-timed output buffer control to eliminate the need to use asynchronous OE
- Fully registered (inputs and outputs) for pipelined operation
- Byte write capability
- Single 2.5 V core power supply ( $V_{DD}$ )
- 2.5 V I/O power supply ( $V_{DDQ}$ )
- Fast clock-to-output times
  - 3.0 ns (for 200-MHz device)
- Clock enable ( $\overline{CEN}$ ) pin to suspend operation
- Synchronous self-timed writes
- Available in JEDEC-standard Pb-free 100-pin TQFP, and non Pb-free 165-ball FBGA packages
- IEEE 1149.1 JTAG-compatible boundary scan
- Burst capability – linear or interleaved burst order
- “ZZ” sleep mode option and stop clock option

## Functional Description

The CY7C1370DV25 and CY7C1372DV25 are 2.5 V, 512K × 36 and 1M × 18 synchronous pipelined burst SRAMs with No Bus Latency™ (NoBL™) logic, respectively. They are designed to support unlimited true back-to-back read/write operations with no wait states. The CY7C1370DV25 and CY7C1372DV25 are equipped with the advanced NoBL logic required to enable consecutive read/write operations with data being transferred on every clock cycle. This feature dramatically improves the throughput of data in systems that require frequent write/read transitions. The CY7C1370DV25 and CY7C1372DV25 are pin-compatible and functionally equivalent to ZBT devices.

All synchronous inputs pass through input registers controlled by the rising edge of the clock. All data outputs pass through output registers controlled by the rising edge of the clock. The clock input is qualified by the clock enable ( $\overline{CEN}$ ) signal, which when deasserted suspends operation and extends the previous clock cycle.

Write operations are controlled by the byte write selects ( $BW_a$ – $BW_d$  for CY7C1370DV25 and  $BW_a$ – $BW_b$  for CY7C1372DV25) and a write enable ( $\overline{WE}$ ) input. All writes are conducted with on-chip synchronous self-timed write circuitry.

Three synchronous chip enables ( $\overline{CE}_1$ ,  $\overline{CE}_2$ ,  $\overline{CE}_3$ ) and an asynchronous output enable ( $\overline{OE}$ ) provide for easy bank selection and output three-state control. In order to avoid bus contention, the output drivers are synchronously three-stated during the data portion of a write sequence.

For a complete list of related documentation, click [here](#).

## Selection Guide

Description	200 MHz	167 MHz	Unit
Maximum access time	3.0	3.4	ns
Maximum operating current	300	275	mA
Maximum CMOS standby current	70	70	mA

**Errata:** For information on silicon errata, see “Errata” on page 30. Details include trigger conditions, devices affected, and proposed workaround.

**Logic Block Diagram – CY7C1370DV25**

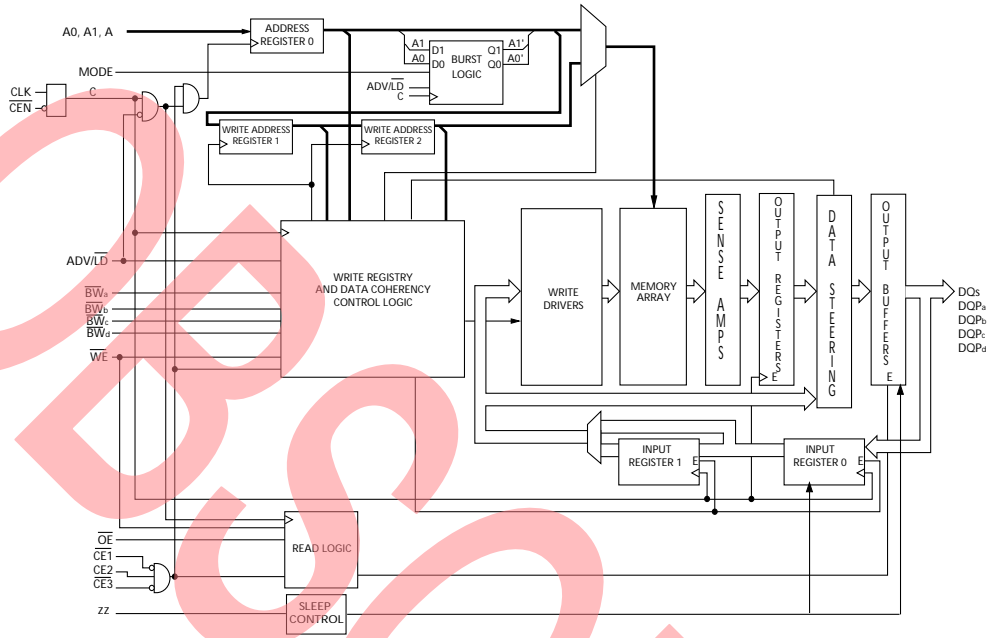

**Logic Block Diagram – CY7C1372DV25**

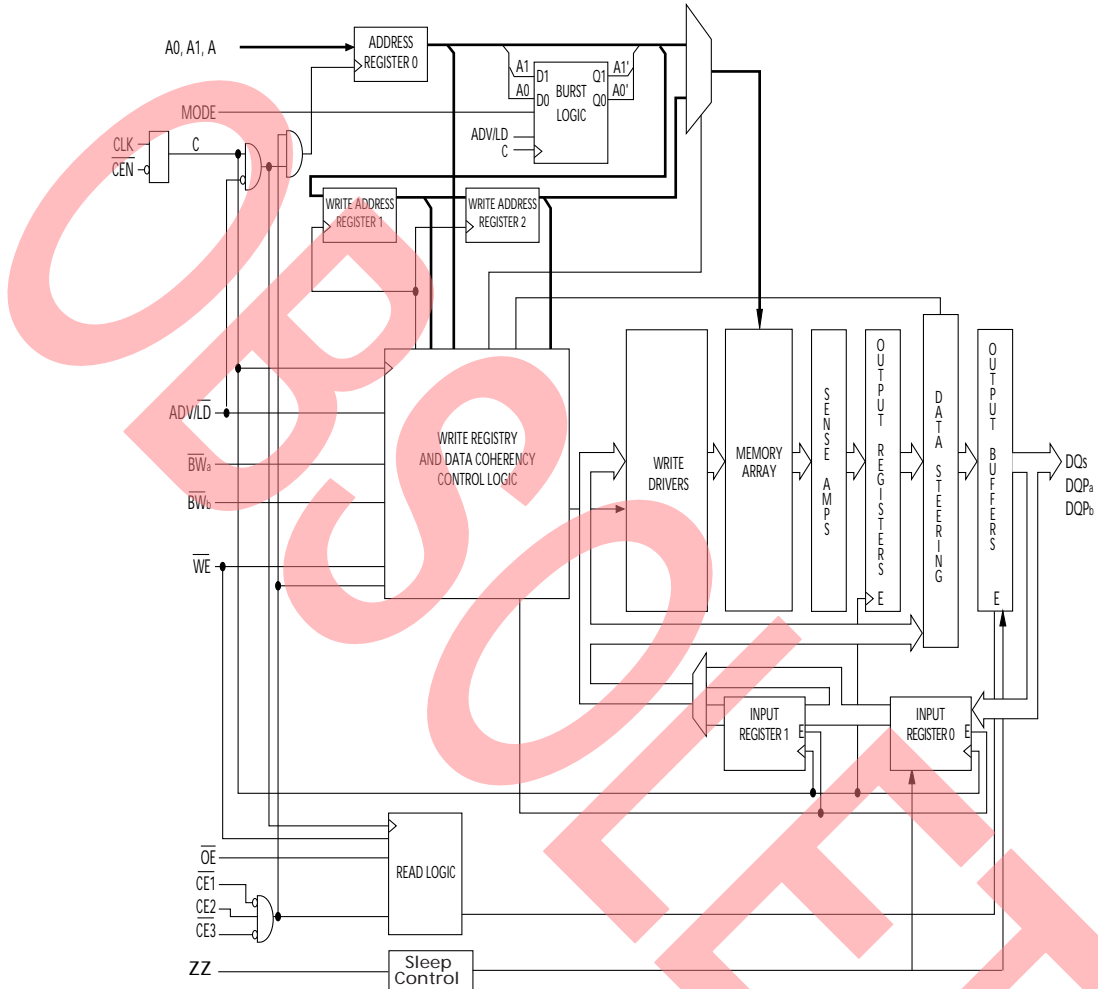

## Contents

<b>Pin Configurations</b> .....	<b>5</b>	<b>Instruction Codes</b> .....	<b>19</b>
<b>Pin Definitions</b> .....	<b>7</b>	<b>Boundary Scan Order</b> .....	<b>20</b>
<b>Functional Overview</b> .....	<b>9</b>	<b>Maximum Ratings</b> .....	<b>21</b>
Single Read Accesses .....	9	<b>Operating Range</b> .....	<b>21</b>
Burst Read Accesses .....	9	<b>Electrical Characteristics</b> .....	<b>21</b>
Single Write Accesses .....	9	<b>Capacitance</b> .....	<b>22</b>
Burst Write Accesses .....	9	<b>Thermal Resistance</b> .....	<b>22</b>
Sleep Mode .....	10	<b>AC Test Loads and Waveforms</b> .....	<b>22</b>
Interleaved Burst Address Table .....	10	<b>Switching Characteristics</b> .....	<b>23</b>
Linear Burst Address Table .....	10	<b>Switching Waveforms</b> .....	<b>24</b>
ZZ Mode Electrical Characteristics .....	10	<b>Ordering Information</b> .....	<b>26</b>
<b>Truth Table</b> .....	<b>11</b>	Ordering Code Definitions .....	26
<b>Partial Truth Table for Read/Write</b> .....	<b>12</b>	<b>Package Diagrams</b> .....	<b>27</b>
<b>Partial Truth Table for Read/Write</b> .....	<b>12</b>	<b>Acronyms</b> .....	<b>29</b>
<b>IEEE 1149.1 Serial Boundary Scan (JTAG [18])</b> .....	<b>13</b>	<b>Document Conventions</b> .....	<b>29</b>
Disabling the JTAG Feature .....	13	Units of Measure .....	29
Test Access Port (TAP) .....	13	<b>Errata</b> .....	<b>30</b>
PERFORMING A TAP RESET .....	13	Part Numbers Affected .....	30
TAP REGISTERS .....	13	Product Status .....	30
TAP Instruction Set .....	14	Ram9 NoBL ZZ Pin & JTAG Issues .....	
<b>TAP Controller State Diagram</b> .....	<b>15</b>	Errata Summary .....	30
<b>TAP Controller Block Diagram</b> .....	<b>16</b>	<b>Document History Page</b> .....	<b>32</b>
<b>TAP Timing</b> .....	<b>16</b>	<b>Sales, Solutions, and Legal Information</b> .....	<b>34</b>
<b>TAP AC Switching Characteristics</b> .....	<b>17</b>	Worldwide Sales and Design Support .....	34
<b>2.5 V TAP AC Test Conditions</b> .....	<b>18</b>	Products .....	34
<b>2.5 V TAP AC Output Load Equivalent</b> .....	<b>18</b>	PSoC® Solutions .....	34
<b>TAP DC Electrical Characteristics and</b>		Cypress Developer Community .....	34
<b>Operating Conditions</b> .....	<b>18</b>	Technical Support .....	34
<b>Scan Register Sizes</b> .....	<b>19</b>		
<b>Identification Register Definitions</b> .....	<b>19</b>		

**Pin Configurations**

**Figure 1. 100-pin TQFP (14 × 20 × 1.4 mm) pinout <sup>[1]</sup>**

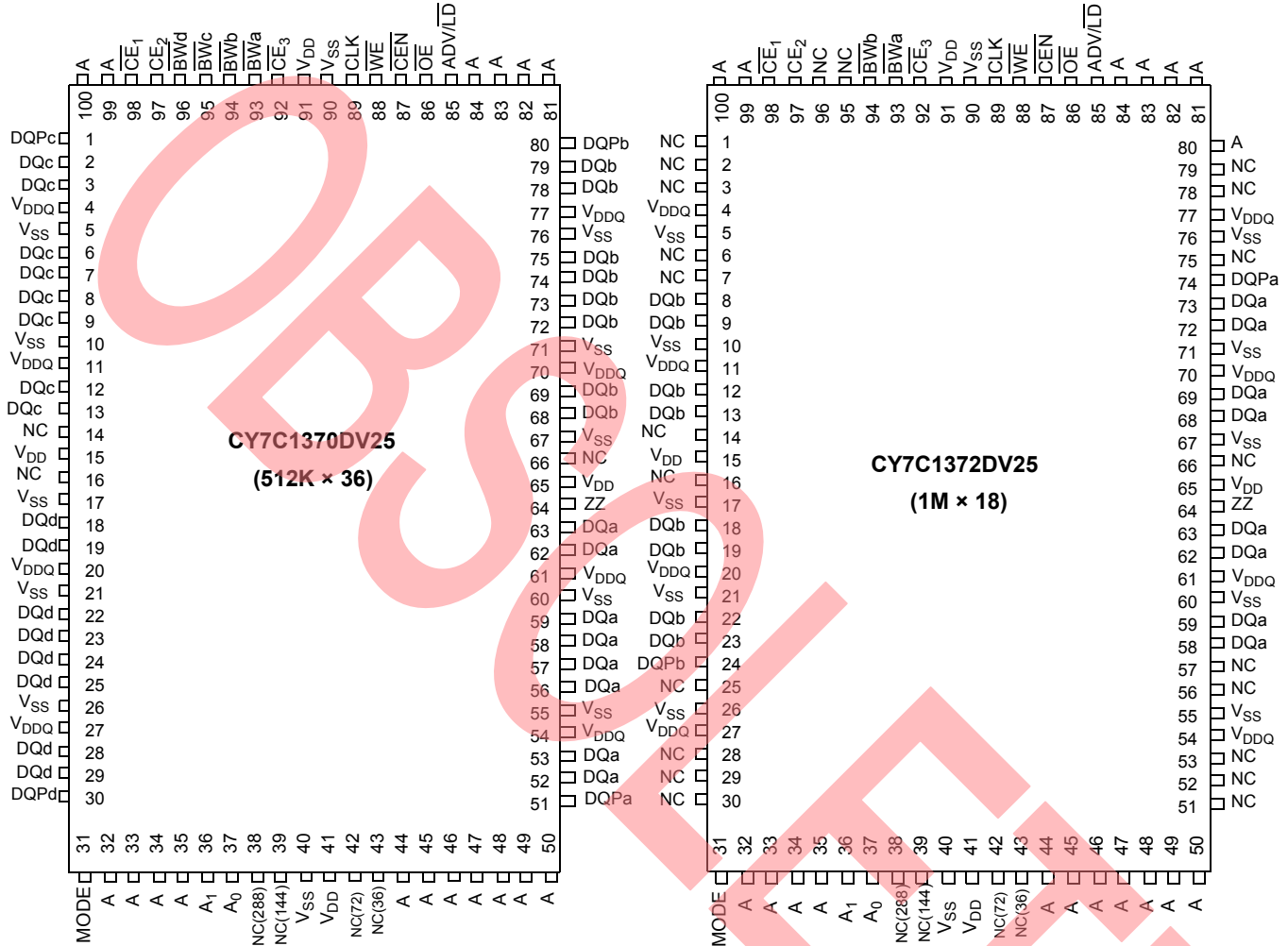

**Note**

- Errata:** The ZZ pin (Pin 64) needs to be externally connected to ground. For more information, see "Errata" on page 30.

**Pin Configurations** (continued)

**Figure 2. 165-ball FBGA (13 × 15 × 1.4 mm) pinout** [2, 3]

**CY7C1370DV25 (512K × 36)**

	1	2	3	4	5	6	7	8	9	10	11
<b>A</b>	NC/576M	A	$\overline{CE}_1$	$\overline{BW}_c$	$\overline{BW}_b$	$\overline{CE}_3$	$\overline{CEN}$	ADV/LD	A	A	NC
<b>B</b>	NC/1G	A	CE2	$\overline{BW}_d$	$\overline{BW}_a$	CLK	$\overline{WE}$	$\overline{OE}$	A	A	NC
<b>C</b>	DQP <sub>c</sub>	NC	V <sub>DDQ</sub>	V <sub>SS</sub>	V <sub>SS</sub>	V <sub>SS</sub>	V <sub>SS</sub>	V <sub>SS</sub>	V <sub>DDQ</sub>	NC	DQP <sub>b</sub>
<b>D</b>	DQ <sub>c</sub>	DQ <sub>c</sub>	V <sub>DDQ</sub>	V <sub>DD</sub>	V <sub>SS</sub>	V <sub>SS</sub>	V <sub>SS</sub>	V <sub>DD</sub>	V <sub>DDQ</sub>	DQ <sub>b</sub>	DQ <sub>b</sub>
<b>E</b>	DQ <sub>c</sub>	DQ <sub>c</sub>	V <sub>DDQ</sub>	V <sub>DD</sub>	V <sub>SS</sub>	V <sub>SS</sub>	V <sub>SS</sub>	V <sub>DD</sub>	V <sub>DDQ</sub>	DQ <sub>b</sub>	DQ <sub>b</sub>
<b>F</b>	DQ <sub>c</sub>	DQ <sub>c</sub>	V <sub>DDQ</sub>	V <sub>DD</sub>	V <sub>SS</sub>	V <sub>SS</sub>	V <sub>SS</sub>	V <sub>DD</sub>	V <sub>DDQ</sub>	DQ <sub>b</sub>	DQ <sub>b</sub>
<b>G</b>	DQ <sub>c</sub>	DQ <sub>c</sub>	V <sub>DDQ</sub>	V <sub>DD</sub>	V <sub>SS</sub>	V <sub>SS</sub>	V <sub>SS</sub>	V <sub>DD</sub>	V <sub>DDQ</sub>	DQ <sub>b</sub>	DQ <sub>b</sub>
<b>H</b>	NC	NC	NC	V <sub>DD</sub>	V <sub>SS</sub>	V <sub>SS</sub>	V <sub>SS</sub>	V <sub>DD</sub>	NC	NC	ZZ
<b>J</b>	DQ <sub>d</sub>	DQ <sub>d</sub>	V <sub>DDQ</sub>	V <sub>DD</sub>	V <sub>SS</sub>	V <sub>SS</sub>	V <sub>SS</sub>	V <sub>DD</sub>	V <sub>DDQ</sub>	DQ <sub>a</sub>	DQ <sub>a</sub>
<b>K</b>	DQ <sub>d</sub>	DQ <sub>d</sub>	V <sub>DDQ</sub>	V <sub>DD</sub>	V <sub>SS</sub>	V <sub>SS</sub>	V <sub>SS</sub>	V <sub>DD</sub>	V <sub>DDQ</sub>	DQ <sub>a</sub>	DQ <sub>a</sub>
<b>L</b>	DQ <sub>d</sub>	DQ <sub>d</sub>	V <sub>DDQ</sub>	V <sub>DD</sub>	V <sub>SS</sub>	V <sub>SS</sub>	V <sub>SS</sub>	V <sub>DD</sub>	V <sub>DDQ</sub>	DQ <sub>a</sub>	DQ <sub>a</sub>
<b>M</b>	DQ <sub>d</sub>	DQ <sub>d</sub>	V <sub>DDQ</sub>	V <sub>DD</sub>	V <sub>SS</sub>	V <sub>SS</sub>	V <sub>SS</sub>	V <sub>DD</sub>	V <sub>DDQ</sub>	DQ <sub>a</sub>	DQ <sub>a</sub>
<b>N</b>	DQP <sub>d</sub>	NC	V <sub>DDQ</sub>	V <sub>SS</sub>	NC	NC	NC	V <sub>SS</sub>	V <sub>DDQ</sub>	NC	DQP <sub>a</sub>
<b>P</b>	NC/144M	NC/72M	A	A	TDI	A1	TDO	A	A	A	NC/288M
<b>R</b>	MODE	NC/36M	A	A	TMS	A0	TCK	A	A	A	A

**CY7C1372DV25 (1M × 18)**

	1	2	3	4	5	6	7	8	9	10	11
<b>A</b>	NC/576M	A	$\overline{CE}_1$	$\overline{BW}_b$	NC	$\overline{CE}_3$	$\overline{CEN}$	ADV/LD	A	A	A
<b>B</b>	NC/1G	A	CE2	NC	$\overline{BW}_a$	CLK	$\overline{WE}$	$\overline{OE}$	A	A	NC
<b>C</b>	NC	NC	V <sub>DDQ</sub>	V <sub>SS</sub>	V <sub>SS</sub>	V <sub>SS</sub>	V <sub>SS</sub>	V <sub>SS</sub>	V <sub>DDQ</sub>	NC	DQP <sub>a</sub>
<b>D</b>	NC	DQ <sub>b</sub>	V <sub>DDQ</sub>	V <sub>DD</sub>	V <sub>SS</sub>	V <sub>SS</sub>	V <sub>SS</sub>	V <sub>DD</sub>	V <sub>DDQ</sub>	NC	DQ <sub>a</sub>
<b>E</b>	NC	DQ <sub>b</sub>	V <sub>DDQ</sub>	V <sub>DD</sub>	V <sub>SS</sub>	V <sub>SS</sub>	V <sub>SS</sub>	V <sub>DD</sub>	V <sub>DDQ</sub>	NC	DQ <sub>a</sub>
<b>F</b>	NC	DQ <sub>b</sub>	V <sub>DDQ</sub>	V <sub>DD</sub>	V <sub>SS</sub>	V <sub>SS</sub>	V <sub>SS</sub>	V <sub>DD</sub>	V <sub>DDQ</sub>	NC	DQ <sub>a</sub>
<b>G</b>	NC	DQ <sub>b</sub>	V <sub>DDQ</sub>	V <sub>DD</sub>	V <sub>SS</sub>	V <sub>SS</sub>	V <sub>SS</sub>	V <sub>DD</sub>	V <sub>DDQ</sub>	NC	DQ <sub>a</sub>
<b>H</b>	NC	NC	NC	V <sub>DD</sub>	V <sub>SS</sub>	V <sub>SS</sub>	V <sub>SS</sub>	V <sub>DD</sub>	NC	NC	ZZ
<b>J</b>	DQ <sub>b</sub>	NC	V <sub>DDQ</sub>	V <sub>DD</sub>	V <sub>SS</sub>	V <sub>SS</sub>	V <sub>SS</sub>	V <sub>DD</sub>	V <sub>DDQ</sub>	DQ <sub>a</sub>	NC
<b>K</b>	DQ <sub>b</sub>	NC	V <sub>DDQ</sub>	V <sub>DD</sub>	V <sub>SS</sub>	V <sub>SS</sub>	V <sub>SS</sub>	V <sub>DD</sub>	V <sub>DDQ</sub>	DQ <sub>a</sub>	NC
<b>L</b>	DQ <sub>b</sub>	NC	V <sub>DDQ</sub>	V <sub>DD</sub>	V <sub>SS</sub>	V <sub>SS</sub>	V <sub>SS</sub>	V <sub>DD</sub>	V <sub>DDQ</sub>	DQ <sub>a</sub>	NC
<b>M</b>	DQ <sub>b</sub>	NC	V <sub>DDQ</sub>	V <sub>DD</sub>	V <sub>SS</sub>	V <sub>SS</sub>	V <sub>SS</sub>	V <sub>DD</sub>	V <sub>DDQ</sub>	DQ <sub>a</sub>	NC
<b>N</b>	DQP <sub>b</sub>	NC	V <sub>DDQ</sub>	V <sub>SS</sub>	NC	NC	NC	V <sub>SS</sub>	V <sub>DDQ</sub>	NC	NC
<b>P</b>	NC/144M	NC/72M	A	A	TDI	A1	TDO	A	A	A	NC/288M
<b>R</b>	MODE	NC/36M	A	A	TMS	A0	TCK	A	A	A	A

**Notes**

2. **Errata:** The ZZ ball (H11) needs to be externally connected to ground. For more information, see "Errata" on page 30.
3. **Errata:** The JTAG testing should be performed with these devices in BYPASS mode as the JTAG functionality is not guaranteed. For more information, see "Errata" on page 30.

## Pin Definitions

Pin Name	I/O Type	Pin Description
A <sub>0</sub> , A <sub>1</sub> , A	Input-synchronous	<b>Address inputs used to select one of the address locations.</b> Sampled at the rising edge of the CLK.
$\overline{BW}_a$ , $\overline{BW}_b$ , $\overline{BW}_c$ , $\overline{BW}_d$	Input-synchronous	<b>Byte write select inputs, active LOW.</b> Qualified with $\overline{WE}$ to conduct writes to the SRAM. Sampled on the rising edge of CLK. $\overline{BW}_a$ controls DQ <sub>a</sub> and DQP <sub>a</sub> , $\overline{BW}_b$ controls DQ <sub>b</sub> and DQP <sub>b</sub> , $\overline{BW}_c$ controls DQ <sub>c</sub> and DQP <sub>c</sub> , $\overline{BW}_d$ controls DQ <sub>d</sub> and DQP <sub>d</sub> .
$\overline{WE}$	Input-synchronous	<b>Write enable input, active LOW.</b> Sampled on the rising edge of CLK if $\overline{CEN}$ is active LOW. This signal must be asserted LOW to initiate a write sequence.
ADV/LD	Input-synchronous	<b>Advance/load input used to advance the on-chip address counter or load a new address.</b> When HIGH (and CEN is asserted LOW) the internal burst counter is advanced. When LOW, a new address can be loaded into the device for an access. After being deselected, ADV/LD should be driven LOW in order to load a new address.
CLK	Input-clock	<b>Clock input.</b> Used to capture all synchronous inputs to the device. CLK is qualified with $\overline{CEN}$ . CLK is only recognized if $\overline{CEN}$ is active LOW.
$\overline{CE}_1$	Input-synchronous	<b>Chip enable 1 input, active LOW.</b> Sampled on the rising edge of CLK. Used in conjunction with $\overline{CE}_2$ and $\overline{CE}_3$ to select/deselect the device.
$\overline{CE}_2$	Input-synchronous	<b>Chip enable 2 input, active HIGH.</b> Sampled on the rising edge of CLK. Used in conjunction with $\overline{CE}_1$ and $\overline{CE}_3$ to select/deselect the device.
$\overline{CE}_3$	Input-synchronous	<b>Chip enable 3 input, active LOW.</b> Sampled on the rising edge of CLK. Used in conjunction with $\overline{CE}_1$ and $\overline{CE}_2$ to select/deselect the device.
$\overline{OE}$	Input-asynchronous	<b>Output enable, active LOW.</b> Combined with the synchronous logic block inside the device to control the direction of the I/O pins. When LOW, the I/O pins are allowed to behave as outputs. When deasserted HIGH, I/O pins are three-stated, and act as input data pins. $\overline{OE}$ is masked during the data portion of a write sequence, during the first clock when emerging from a deselected state and when the device has been deselected.
$\overline{CEN}$	Input-synchronous	<b>Clock enable input, active LOW.</b> When asserted LOW the clock signal is recognized by the SRAM. When deasserted HIGH the clock signal is masked. Since deasserting $\overline{CEN}$ does not deselect the device, $\overline{CEN}$ can be used to extend the previous cycle when required.
DQ <sub>s</sub>	I/O-synchronous	<b>Bidirectional data I/O lines.</b> As inputs, they feed into an on-chip data register that is triggered by the rising edge of CLK. As outputs, they deliver the data contained in the memory location specified by A <sub>[17:0]</sub> during the previous clock rise of the read cycle. The direction of the pins is controlled by $\overline{OE}$ and the internal control logic. When $\overline{OE}$ is asserted LOW, the pins can behave as outputs. When HIGH, DQ <sub>a</sub> –DQ <sub>d</sub> are placed in a three-state condition. The outputs are automatically three-stated during the data portion of a write sequence, during the first clock when emerging from a deselected state, and when the device is deselected, regardless of the state of $\overline{OE}$ .
DQP <sub>x</sub>	I/O-synchronous	<b>Bidirectional data parity I/O lines.</b> Functionally, these signals are identical to DQ <sub>s</sub> . During write sequences, DQP <sub>a</sub> is controlled by $\overline{BW}_a$ , DQP <sub>b</sub> is controlled by $\overline{BW}_b$ , DQP <sub>c</sub> is controlled by $\overline{BW}_c$ , and DQP <sub>d</sub> is controlled by $\overline{BW}_d$ .
MODE	Input strap pin	<b>Mode input.</b> Selects the burst order of the device. Tied HIGH selects the interleaved burst order. Pulled LOW selects the linear burst order. MODE should not change states during operation. When left floating MODE will default HIGH, to an interleaved burst order.

**Pin Definitions** (continued)

Pin Name	I/O Type	Pin Description
TDO <sup>[4]</sup>	JTAG serial output synchronous	<b>Serial data-out to the JTAG circuit.</b> Delivers data on the negative edge of TCK.
TDI <sup>[4]</sup>	JTAG serial input synchronous	<b>Serial data-in to the JTAG circuit.</b> Sampled on the rising edge of TCK.
TMS <sup>[4]</sup>	Test mode select synchronous	<b>This pin controls the Test access port state machine.</b> Sampled on the rising edge of TCK.
TCK <sup>[4]</sup>	JTAG-clock	<b>Clock input to the JTAG circuitry.</b>
V <sub>DD</sub>	Power supply	<b>Power supply inputs to the core of the device.</b>
V <sub>DDQ</sub>	I/O power supply	<b>Power supply for the I/O circuitry.</b>
V <sub>SS</sub>	Ground	<b>Ground for the device.</b> Should be connected to ground of the system.
NC	–	<b>No connects.</b> This pin is not connected to the die.
NC/36M, NC/72M, NC/144M, NC/288M, NC/576M, NC/1G	–	<b>These pins are not connected.</b> They will be used for expansion to the 36M, 72M, 144M, 288M, 576M, and 1G densities.
ZZ <sup>[5]</sup>	Input- asynchronous	<b>ZZ “sleep” input.</b> This active HIGH input places the device in a non-time critical “sleep” condition with data integrity preserved. For normal operation, this pin has to be LOW or left floating. ZZ pin has an internal pull-down.

**Notes**

4. **Errata:** The JTAG testing should be performed with these devices in BYPASS mode as the JTAG functionality is not guaranteed. For more information, see “Errata” on page 30.
5. **Errata:** The ZZ pin needs to be externally connected to ground. For more information, see “Errata” on page 30.

## Functional Overview

The CY7C1370DV25 and CY7C1372DV25 are synchronous-pipelined Burst NoBL SRAMs designed specifically to eliminate wait states during write/read transitions. All synchronous inputs pass through input registers controlled by the rising edge of the clock. The clock signal is qualified with the clock enable input signal (CEN). If CEN is HIGH, the clock signal is not recognized and all internal states are maintained. All synchronous operations are qualified with CEN. All data outputs pass through output registers controlled by the rising edge of the clock. Maximum access delay from the clock rise ( $t_{CO}$ ) is 3.0 ns (200-MHz device).

Accesses can be initiated by asserting all three chip enables ( $\overline{CE}_1$ ,  $\overline{CE}_2$ ,  $\overline{CE}_3$ ) active at the rising edge of the clock. If clock enable (CEN) is active LOW and ADV/LD is asserted LOW, the address presented to the device will be latched. The access can either be a read or write operation, depending on the status of the write enable ( $\overline{WE}$ ).  $\overline{BW}_X$  can be used to conduct byte write operations.

Write operations are qualified by the write enable ( $\overline{WE}$ ). All writes are simplified with on-chip synchronous self-timed write circuitry.

Three synchronous chip enables ( $\overline{CE}_1$ ,  $\overline{CE}_2$ ,  $\overline{CE}_3$ ) and an asynchronous output enable ( $\overline{OE}$ ) simplify depth expansion. All operations (reads, writes, and deselections) are pipelined. ADV/LD should be driven LOW once the device has been deselected in order to load a new address for the next operation.

### Single Read Accesses

A read access is initiated when the following conditions are satisfied at clock rise: (1) CEN is asserted LOW, (2)  $\overline{CE}_1$ ,  $\overline{CE}_2$ , and  $\overline{CE}_3$  are all asserted active, (3) the write enable input signal  $\overline{WE}$  is deasserted HIGH, and (4) ADV/LD is asserted LOW. The address presented to the address inputs is latched into the address register and presented to the memory core and control logic. The control logic determines that a read access is in progress and allows the requested data to propagate to the input of the output register. At the rising edge of the next clock the requested data is allowed to propagate through the output register and onto the data bus within 3.0ns (200-MHz device) provided OE is active LOW. After the first clock of the read access the output buffers are controlled by  $\overline{OE}$  and the internal control logic.  $\overline{OE}$  must be driven LOW in order for the device to drive out the requested data. During the second clock, a subsequent operation (read/write/deselect) can be initiated. Deselecting the device is also pipelined. Therefore, when the SRAM is deselected at clock rise by one of the chip enable signals, its output will three-state following the next clock rise.

### Burst Read Accesses

The CY7C1370DV25 and CY7C1372DV25 have an on-chip burst counter that allows the user the ability to supply a single address and conduct up to four reads without reasserting the address inputs. ADV/LD must be driven LOW in order to load a new address into the SRAM, as described in [Single Read Accesses](#). The sequence of the burst counter is determined by the MODE input signal. A LOW input on MODE selects a linear burst mode, a HIGH selects an interleaved burst sequence. Both burst counters use A0 and A1 in the burst sequence, and will wrap around when incremented sufficiently. A HIGH input on

ADV/LD will increment the internal burst counter regardless of the state of chip enables inputs or WE. WE is latched at the beginning of a burst cycle. Therefore, the type of access (read or write) is maintained throughout the burst sequence.

### Single Write Accesses

Write access are initiated when the following conditions are satisfied at clock rise: (1) CEN is asserted LOW, (2)  $\overline{CE}_1$ ,  $\overline{CE}_2$ , and  $\overline{CE}_3$  are all asserted active, and (3) the write signal  $\overline{WE}$  is asserted LOW. The address presented is loaded into the address register. The write signals are latched into the control logic block.

On the subsequent clock rise the data lines are automatically three-stated regardless of the state of the  $\overline{OE}$  input signal. This allows the external logic to present the data on DQ and DQP ( $DQ_{a,b,c,d}/DQP_{a,b,c,d}$  for CY7C1370DV25 and  $DQ_{a,b}/DQP_{a,b}$  for CY7C1372DV25). In addition, the address for the subsequent access (read/write/deselect) is latched into the address register (provided the appropriate control signals are asserted).

On the next clock rise the data presented to DQ and DQP ( $DQ_{a,b,c,d}/DQP_{a,b,c,d}$  for CY7C1370DV25 &  $DQ_{a,b}/DQP_{a,b}$  for CY7C1372DV25) (or a subset for byte write operations, see Write Cycle Description table for details) inputs is latched into the device and the write is complete.

The data written during the write operation is controlled by  $\overline{BW}$  ( $\overline{BW}_{a,b,c,d}$  for CY7C1370DV25 and  $\overline{BW}_{a,b}$  for CY7C1372DV25) signals. The CY7C1370DV25/CY7C1372DV25 provides byte write capability that is described in the Write Cycle Description table. Asserting the write enable input (WE) with the selected byte write select (BW) input will selectively write to only the desired bytes. Bytes not selected during a byte write operation will remain unaltered. A synchronous self-timed write mechanism has been provided to simplify the write operations. Byte write capability has been included in order to greatly simplify read/modify/write sequences, which can be reduced to simple byte write operations.

Because the CY7C1370DV25 and CY7C1372DV25 are common I/O devices, data should not be driven into the device while the outputs are active. The output enable ( $\overline{OE}$ ) can be deasserted HIGH before presenting data to the DQ and DQP ( $DQ_{a,b,c,d}/DQP_{a,b,c,d}$  for CY7C1370DV25 and  $DQ_{a,b}/DQP_{a,b}$  for CY7C1372DV25) inputs. Doing so will three-state the output drivers. As a safety precaution, DQ and DQP ( $DQ_{a,b,c,d}/DQP_{a,b,c,d}$  for CY7C1370DV25 and  $DQ_{a,b}/DQP_{a,b}$  for CY7C1372DV25) are automatically three-stated during the data portion of a write cycle, regardless of the state of  $\overline{OE}$ .

### Burst Write Accesses

The CY7C1370DV25/CY7C1372DV25 has an on-chip burst counter that allows the user the ability to supply a single address and conduct up to four write operations without reasserting the address inputs. ADV/LD must be driven LOW in order to load the initial address, as described in [Single Write Accesses on page 9](#). When ADV/LD is driven HIGH on the subsequent clock rise, the chip enables ( $\overline{CE}_1$ ,  $\overline{CE}_2$ , and  $\overline{CE}_3$ ) and WE inputs are ignored and the burst counter is incremented. The correct BW ( $\overline{BW}_{a,b,c,d}$  for CY7C1370DV25 and  $\overline{BW}_{a,b}$  for CY7C1372DV25) inputs must be driven in each cycle of the burst write in order to write the correct bytes of data.

### Sleep Mode

The ZZ input pin is an asynchronous input. Asserting ZZ places the SRAM in a power conservation “sleep” mode. Two clock cycles are required to enter into or exit from this “sleep” mode. While in this mode, data integrity is guaranteed. Accesses pending when entering the “sleep” mode are not considered valid nor is the completion of the operation guaranteed. The device must be deselected prior to entering the “sleep” mode. CE<sub>1</sub>, CE<sub>2</sub>, and CE<sub>3</sub>, must remain inactive for the duration of t<sub>ZZREC</sub> after the ZZ input returns LOW.

### Linear Burst Address Table

(MODE = GND)

First Address A1:A0	Second Address A1:A0	Third Address A1:A0	Fourth Address A1:A0
00	01	10	11
01	10	11	00
10	11	00	01
11	00	01	10

### Interleaved Burst Address Table

(MODE = Floating or V<sub>DD</sub>)

First Address A1:A0	Second Address A1:A0	Third Address A1:A0	Fourth Address A1:A0
00	01	10	11
01	00	11	10
10	11	00	01
11	10	01	00

### ZZ Mode Electrical Characteristics

Parameter	Description	Test Conditions	Min	Max	Unit
I <sub>DDZZ</sub>	Sleep mode standby current	ZZ ≥ V <sub>DD</sub> - 0.2 V	–	80	mA
t <sub>ZZS</sub>	Device operation to ZZ	ZZ ≥ V <sub>DD</sub> - 0.2 V	–	2t <sub>CYC</sub>	ns
t <sub>ZZREC</sub>	ZZ recovery time	ZZ ≤ 0.2 V	2t <sub>CYC</sub>	–	ns
t <sub>ZZI</sub>	ZZ active to sleep current	This parameter is sampled	–	2t <sub>CYC</sub>	ns
t <sub>RZZI</sub>	ZZ Inactive to exit sleep current	This parameter is sampled	0	–	ns

## Truth Table

The truth table for CY7C1370DV25/CY7C1372DV25 follows. [6, 7, 8, 9, 10, 11, 12]

Operation	Address Used	CE	ZZ	ADV/LD	WE	BW <sub>x</sub>	OE	CEN	CLK	DQ
Deselect cycle	None	H	L	L	X	X	X	L	L-H	Tri-state
Continue deselect cycle	None	X	L	H	X	X	X	L	L-H	Tri-state
Read cycle (begin burst)	External	L	L	L	H	X	L	L	L-H	Data out (Q)
Read cycle (continue burst)	Next	X	L	H	X	X	L	L	L-H	Data out (Q)
NOP/dummy read (begin burst)	External	L	L	L	H	X	H	L	L-H	Tri-state
Dummy read (continue burst)	Next	X	L	H	X	X	H	L	L-H	Tri-state
Write cycle (begin burst)	External	L	L	L	L	L	X	L	L-H	Data in (D)
Write cycle (continue burst)	Next	X	L	H	X	L	X	L	L-H	Data in (D)
NOP/write abort (begin burst)	None	L	L	L	L	H	X	L	L-H	Tri-state
Write abort (continue burst)	Next	X	L	H	X	H	X	L	L-H	Tri-state
Ignore clock edge (stall)	Current	X	L	X	X	X	X	H	L-H	-
Sleep mode	None	X	H	X	X	X	X	X	X	Tri-state

### Notes

6. X = "Don't Care", H = Logic HIGH, L = Logic LOW,  $\overline{CE}$  stands for all chip enables active.  $\overline{BW}_x = L$  signifies at least one byte write select is active,  $\overline{BW}_x = \text{valid}$  signifies that the desired byte write selects are asserted, see Write Cycle Description table for details.
7. Write is defined by  $\overline{WE}$  and  $\overline{BW}_x$ . See Write Cycle Description table for details.
8. When a write cycle is detected, all I/Os are tri-stated, even during byte writes.
9. The DQ and DQP pins are controlled by the current cycle and the  $\overline{OE}$  signal.
10.  $\overline{CEN} = H$  inserts wait states.
11. Device will power-up deselected and the I/Os in a tri-state condition, regardless of  $\overline{OE}$ .
12.  $\overline{OE}$  is asynchronous and is not sampled with the clock rise. It is masked internally during write cycles. During a read cycle  $DQ_s$  and  $DQP_x$  = three-state when  $\overline{OE}$  is inactive or when the device is deselected, and  $DQ_s$  = data when  $\overline{OE}$  is active.
13. Table only lists a partial listing of the byte write combinations. Any Combination of  $\overline{BW}_x$  is valid. Appropriate write will be done based on which byte write is active.

### Partial Truth Table for Read/Write

The partial truth table for Read/Write for CY7C1370DV25 follows. [14, 15, 16, 17]

Function (CY7C1370DV25)	WE	BW <sub>d</sub>	BW <sub>c</sub>	BW <sub>b</sub>	BW <sub>a</sub>
Read	H	X	X	X	X
Write – No bytes written	L	H	H	H	H
Write byte a – (DQ <sub>a</sub> and DQP <sub>a</sub> )	L	H	H	H	L
Write byte b – (DQ <sub>b</sub> and DQP <sub>b</sub> )	L	H	H	L	H
Write bytes b, a	L	H	H	L	L
Write byte c – (DQ <sub>c</sub> and DQP <sub>c</sub> )	L	H	L	H	H
Write bytes c, a	L	H	L	H	L
Write bytes c, b	L	H	L	L	H
Write bytes c, b, a	L	H	L	L	L
Write byte d – (DQ <sub>d</sub> and DQP <sub>d</sub> )	L	L	H	H	H
Write bytes d, a	L	L	H	H	L
Write bytes d, b	L	L	H	L	H
Write bytes d, b, a	L	L	H	L	L
Write bytes d, c	L	L	L	H	H
Write bytes d, c, a	L	L	L	H	L
Write bytes d, c, b	L	L	L	L	H
Write all bytes	L	L	L	L	L

### Partial Truth Table for Read/Write

The partial truth table for Read/Write for CY7C1372DV25 follows. [14, 15, 16, 17]

Function (CY7C1372DV25)	WE	BW <sub>b</sub>	BW <sub>a</sub>
Read	H	X	X
Write – no bytes written	L	H	H
Write byte a – (DQ <sub>a</sub> and DQP <sub>a</sub> )	L	H	L
Write byte b – (DQ <sub>b</sub> and DQP <sub>b</sub> )	L	L	H
Write both bytes	L	L	L

#### Notes

14. X = "Don't Care", H = Logic HIGH, L = Logic LOW,  $\overline{\text{CE}}$  stands for all chip enables active.  $\overline{\text{BW}}_x = \text{L}$  signifies at least one byte write select is active,  $\overline{\text{BW}}_x = \text{valid}$  signifies that the desired byte write selects are asserted, see Write Cycle Description table for details.
15. Write is defined by WE and BW<sub>x</sub>. See Write Cycle Description table for details.
16. When a write cycle is detected, all I/Os are tri-stated, even during byte writes.
17. Table only lists a partial listing of the byte write combinations. Any Combination of BW<sub>x</sub> is valid. Appropriate write will be done based on which byte write is active.

## IEEE 1149.1 Serial Boundary Scan (JTAG) <sup>[18]</sup>

The CY7C1370DV25/CY7C1372DV25 incorporates a serial boundary scan test access port (TAP). This part is fully compliant with 1149.1. The TAP operates using JEDEC-standard 3.3 V or 2.5 V I/O logic levels.

The CY7C1370DV25/CY7C1372DV25 contains a TAP controller, instruction register, boundary scan register, bypass register, and ID register.

### Disabling the JTAG Feature

It is possible to operate the SRAM without using the JTAG feature. To disable the TAP controller, TCK must be tied LOW ( $V_{SS}$ ) to prevent clocking of the device. TDI and TMS are internally pulled up and may be unconnected. They may alternately be connected to  $V_{DD}$  through a pull-up resistor. TDO should be left unconnected. Upon power-up, the device will come up in a reset state which will not interfere with the operation of the device.

### Test Access Port (TAP)

#### Test Clock (TCK)

The test clock is used only with the TAP controller. All inputs are captured on the rising edge of TCK. All outputs are driven from the falling edge of TCK.

#### Test Mode Select (TMS)

The TMS input is used to give commands to the TAP controller and is sampled on the rising edge of TCK. It is allowable to leave this ball unconnected if the TAP is not used. The ball is pulled up internally, resulting in a logic HIGH level.

#### Test Data-In (TDI)

The TDI ball is used to serially input information into the registers and can be connected to the input of any of the registers. The register between TDI and TDO is chosen by the instruction that is loaded into the TAP instruction register. For information on loading the instruction register, see [TAP Controller State Diagram on page 15](#). TDI is internally pulled up and can be unconnected if the TAP is unused in an application. TDI is connected to the most significant bit (MSB) of any register.

#### Test Data-Out (TDO)

The TDO output ball is used to serially clock data-out from the registers. The output is active depending upon the current state of the TAP state machine (see [Instruction Codes on page 19](#)). The output changes on the falling edge of TCK. TDO is connected to the least significant bit (LSB) of any register.

### Performing a TAP Reset

A RESET is performed by forcing TMS HIGH ( $V_{DD}$ ) for five rising edges of TCK. This RESET does not affect the operation of the SRAM and may be performed while the SRAM is operating.

At power-up, the TAP is reset internally to ensure that TDO comes up in a high Z state.

### TAP Registers

Registers are connected between the TDI and TDO balls and allow data to be scanned into and out of the SRAM test circuitry. Only one register can be selected at a time through the instruction register. Data is serially loaded into the TDI ball on the rising edge of TCK. Data is output on the TDO ball on the falling edge of TCK.

#### Instruction Register

Three-bit instructions can be serially loaded into the instruction register. This register is loaded when it is placed between the TDI and TDO balls as shown in the [TAP Controller Block Diagram on page 16](#). Upon power-up, the instruction register is loaded with the IDCODE instruction. It is also loaded with the IDCODE instruction if the controller is placed in a reset state as described in the previous section.

When the TAP controller is in the Capture-IR state, the two least significant bits are loaded with a binary "01" pattern to allow for fault isolation of the board-level serial test data path.

#### Bypass Register

To save time when serially shifting data through registers, it is sometimes advantageous to skip certain chips. The bypass register is a single-bit register that can be placed between the TDI and TDO balls. This allows data to be shifted through the SRAM with minimal delay. The bypass register is set LOW ( $V_{SS}$ ) when the BYPASS instruction is executed.

#### Boundary Scan Register

The boundary scan register is connected to all the input and bidirectional balls on the SRAM.

The boundary scan register is loaded with the contents of the RAM I/O ring when the TAP controller is in the Capture-DR state and is then placed between the TDI and TDO balls when the controller is moved to the Shift-DR state. The EXTEST, SAMPLE/PRELOAD and SAMPLE Z instructions can be used to capture the contents of the I/O ring.

The [Boundary Scan Order on page 20](#) show the order in which the bits are connected. Each bit corresponds to one of the bumps on the SRAM package. The MSB of the register is connected to TDI and the LSB is connected to TDO.

#### Identification (ID) Register

The ID register is loaded with a vendor-specific, 32-bit code during the Capture-DR state when the IDCODE command is loaded in the instruction register. The IDCODE is hardwired into the SRAM and can be shifted out when the TAP controller is in the Shift-DR state. The ID register has a vendor code and other information described in [Identification Register Definitions on page 19](#).

#### Note

18. **Errata:** The JTAG testing should be performed with these devices in BYPASS mode as the JTAG functionality is not guaranteed. For more information, see "Errata" on page 30.

## TAP Instruction Set

### Overview

Eight different instructions are possible with the three bit instruction register. All combinations are listed in the Instruction Codes table. Three of these instructions are listed as RESERVED and should not be used. The other five instructions are described in detail below.

Instructions are loaded into the TAP controller during the Shift-IR state when the instruction register is placed between TDI and TDO. During this state, instructions are shifted through the instruction register through the TDI and TDO balls. To execute the instruction once it is shifted in, the TAP controller needs to be moved into the Update-IR state.

### EXTEST

The EXTEST instruction enables the preloaded data to be driven out through the system output pins. This instruction also selects the boundary scan register to be connected for serial access between the TDI and TDO in the shift-DR controller state.

### IDCODE

The IDCODE instruction causes a vendor-specific, 32-bit code to be loaded into the instruction register. It also places the instruction register between the TDI and TDO balls and allows the IDCODE to be shifted out of the device when the TAP controller enters the Shift-DR state.

The IDCODE instruction is loaded into the instruction register upon power-up or whenever the TAP controller is given a test logic reset state.

### SAMPLE Z

The SAMPLE Z instruction causes the boundary scan register to be connected between the TDI and TDO balls when the TAP controller is in a Shift-DR state. It also places all SRAM outputs into a high Z state.

### SAMPLE/PRELOAD

SAMPLE/PRELOAD is a 1149.1 mandatory instruction. When the SAMPLE/PRELOAD instructions are loaded into the instruction register and the TAP controller is in the Capture-DR state, a snapshot of data on the inputs and output pins is captured in the boundary scan register.

The user must be aware that the TAP controller clock can only operate at a frequency up to 20 MHz, while the SRAM clock operates more than an order of magnitude faster. Because there is a large difference in the clock frequencies, it is possible that during the Capture-DR state, an input or output will undergo a transition. The TAP may then try to capture a signal while in transition (metastable state). This will not harm the device, but there is no guarantee as to the value that will be captured. Repeatable results may not be possible.

To guarantee that the boundary scan register will capture the correct value of a signal, the SRAM signal must be stabilized long enough to meet the TAP controller's capture set-up plus hold times ( $t_{CS}$  and  $t_{CH}$ ). The SRAM clock input might not be captured correctly if there is no way in a design to stop (or slow) the clock during a SAMPLE/PRELOAD instruction. If this is an issue, it is still possible to capture all other signals and simply ignore the value of the CK and CK captured in the boundary scan register.

Once the data is captured, it is possible to shift out the data by putting the TAP into the Shift-DR state. This places the boundary scan register between the TDI and TDO pins.

PRELOAD allows an initial data pattern to be placed at the latched parallel outputs of the boundary scan register cells prior to the selection of another boundary scan test operation.

The shifting of data for the SAMPLE and PRELOAD phases can occur concurrently when required – that is, while data captured is shifted out, the preloaded data can be shifted in.

### BYPASS

When the BYPASS instruction is loaded in the instruction register and the TAP is placed in a Shift-DR state, the bypass register is placed between the TDI and TDO balls. The advantage of the BYPASS instruction is that it shortens the boundary scan path when multiple devices are connected together on a board.

### EXTEST Output Bus Tri-State

IEEE Standard 1149.1 mandates that the TAP controller be able to put the output bus into a tri-state mode.

The boundary scan register has a special bit located at bbit #89 (for 165-ball FBGA package). When this scan cell, called the "extest output bus tri-state," is latched into the preload register during the "Update-DR" state in the TAP controller, it will directly control the state of the output (Q-bus) pins, when the EXTEST is entered as the current instruction. When HIGH, it will enable the output buffers to drive the output bus. When LOW, this bit will place the output bus into a high Z condition.

This bit can be set by entering the SAMPLE/PRELOAD or EXTEST command, and then shifting the desired bit into that cell, during the "Shift-DR" state. During "Update-DR," the value loaded into that shift-register cell will latch into the preload register. When the EXTEST instruction is entered, this bit will directly control the output Q-bus pins. Note that this bit is preset HIGH to enable the output when the device is powered-up, and also when the TAP controller is in the "Test-Logic-Reset" state.

### Reserved

These instructions are not implemented but are reserved for future use. Do not use these instructions.

### TAP Controller State Diagram

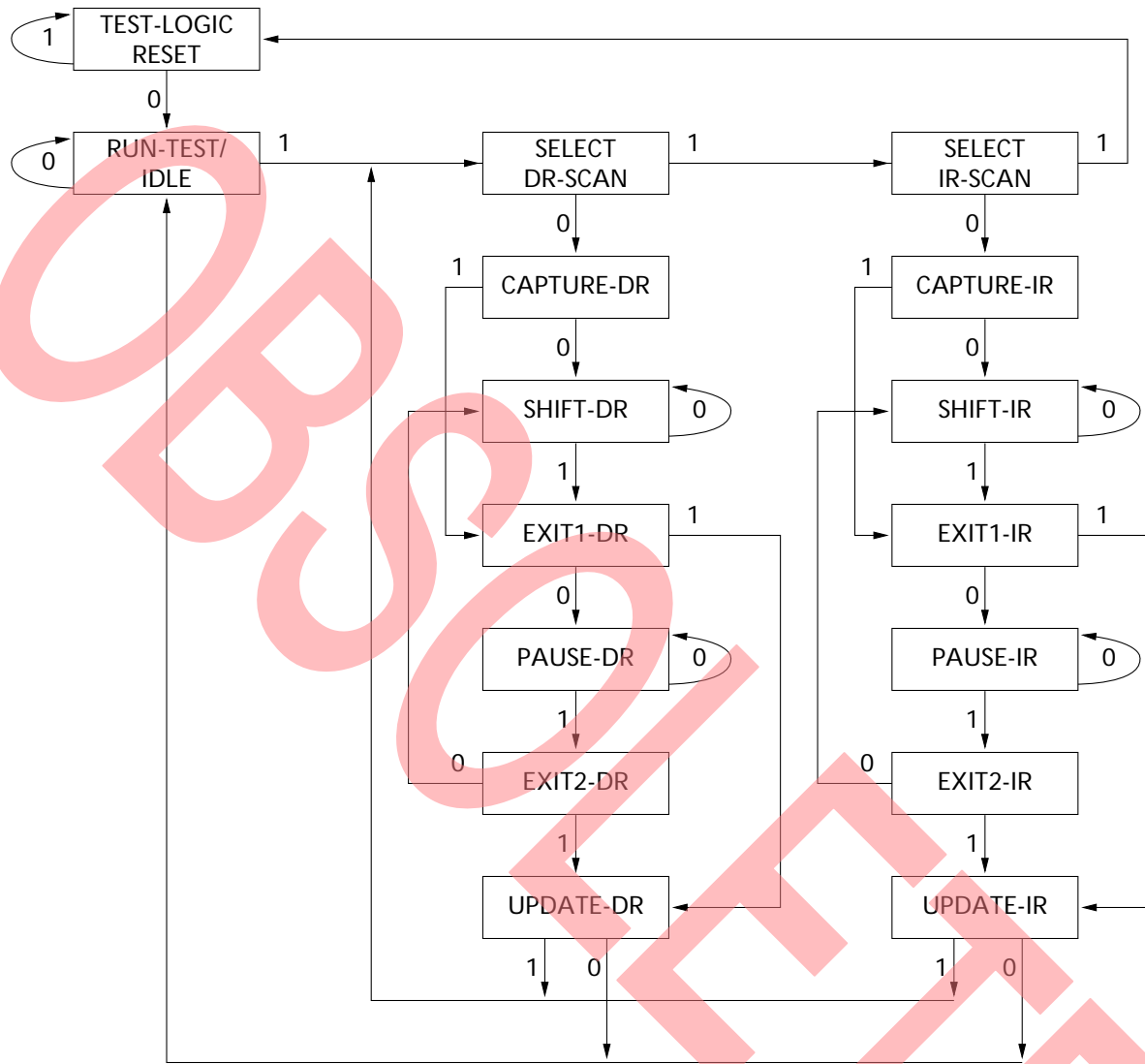

The 0/1 next to each state represents the value of TMS at the rising edge of TCK.

### TAP Controller Block Diagram

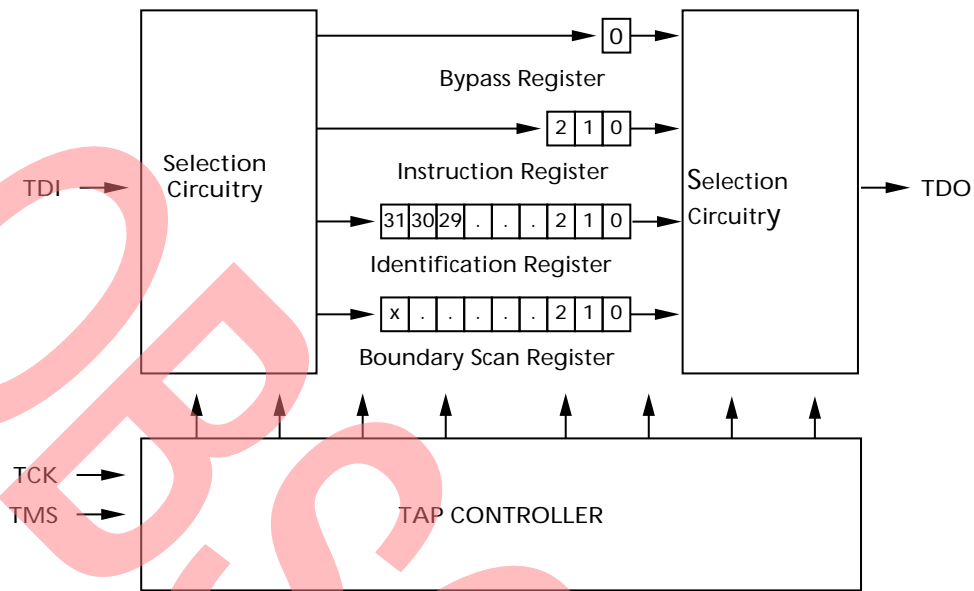

### TAP Timing

Figure 3. TAP Timing

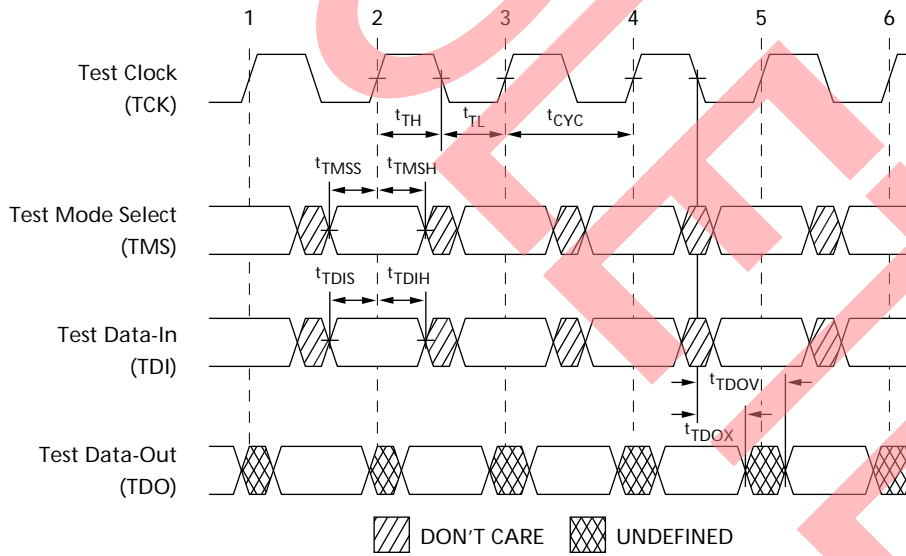

## TAP AC Switching Characteristics

Over the Operating Range

Parameter <sup>[19, 20]</sup>	Description	Min	Max	Unit
<b>Clock</b>				
$t_{TCYC}$	TCK clock cycle time	50	–	ns
$t_{TF}$	TCK clock frequency	–	20	MHz
$t_{TH}$	TCK clock HIGH time	20	–	ns
$t_{TL}$	TCK clock LOW time	20	–	ns
<b>Output Times</b>				
$t_{TDOV}$	TCK clock LOW to TDO valid	–	10	ns
$t_{TDOX}$	TCK clock LOW to TDO invalid	0	–	ns
<b>Set-up Times</b>				
$t_{TMSS}$	TMS set-up to TCK clock rise	5	–	ns
$t_{TDIS}$	TDI set-up to TCK clock rise	5	–	ns
$t_{CS}$	Capture set-up to TCK rise	5	–	ns
<b>Hold Times</b>				
$t_{TMSh}$	TMS hold after TCK clock rise	5	–	ns
$t_{TDIH}$	TDI hold after clock rise	5	–	ns
$t_{CH}$	Capture hold after clock rise	5	–	ns

### Notes

19.  $t_{CS}$  and  $t_{CH}$  refer to the set-up and hold time requirements of latching data from the boundary scan register.  
 20. Test conditions are specified using the load in TAP AC test Conditions.  $t_R/t_F = 1$  ns.

**2.5 V TAP AC Test Conditions**

Input pulse levels .....  $V_{SS}$  to 2.5 V  
 Input rise and fall time ..... 1 ns  
 Input timing reference levels ..... 1.25 V  
 Output reference levels ..... 1.25 V  
 Test load termination supply voltage ..... 1.25 V

**2.5 V TAP AC Output Load Equivalent**

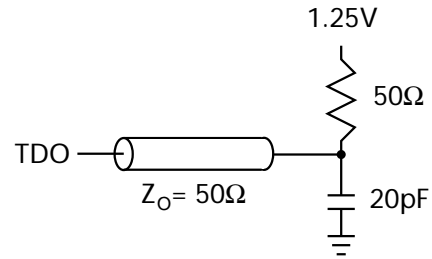

**TAP DC Electrical Characteristics and Operating Conditions**

(0 °C < T<sub>A</sub> < +70 °C; V<sub>DD</sub> = 2.5 V ± 0.125 V unless otherwise noted)

Parameter <sup>[21]</sup>	Description	Test Conditions	Min	Max	Unit
V <sub>OH1</sub>	Output HIGH voltage	I <sub>OH</sub> = -1.0 mA, V <sub>DDQ</sub> = 2.5 V	2.0	-	V
V <sub>OH2</sub>	Output HIGH voltage	I <sub>OH</sub> = -100 μA, V <sub>DDQ</sub> = 2.5 V	2.1	-	V
V <sub>OL1</sub>	Output LOW voltage	I <sub>OL</sub> = 8.0 mA, V <sub>DDQ</sub> = 2.5 V	-	0.4	V
V <sub>OL2</sub>	Output LOW voltage	I <sub>OL</sub> = 100 μA V <sub>DDQ</sub> = 2.5 V	-	0.2	V
V <sub>IH</sub>	Input HIGH voltage	V <sub>DDQ</sub> = 2.5 V	1.7	V <sub>DD</sub> + 0.3	V
V <sub>IL</sub>	Input LOW voltage	V <sub>DDQ</sub> = 2.5 V	-0.3	0.7	V
I <sub>X</sub>	Input load current	GND ≤ V <sub>IN</sub> ≤ V <sub>DDQ</sub>	-5	5	μA

**Note**  
 21. All voltages referenced to V<sub>SS</sub> (GND).

### Scan Register Sizes

Register Name	Bit Size (× 18)	Bit Size (× 36)
Instruction	3	3
Bypass	1	1
ID	32	32
Boundary scan order (165-ball FBGA package)	89	89

### Identification Register Definitions

Instruction Field	CY7C1370DV25	CY7C1372DV25	Description
Revision number (31:29)	000	000	Reserved for version number.
Cypress device ID (28:12)	01011001000010101	01011001000100101	Reserved for future use.
Cypress JEDEC ID (11:1)	00000110100	00000110100	Allows unique identification of SRAM vendor.
ID register presence (0)	1	1	Indicate the presence of an ID register.

### Instruction Codes

Instruction	Code	Description
EXTEST	000	Captures I/O ring contents. Places the boundary scan register between TDI and TDO. Forces all SRAM outputs to high Z state.
IDCODE	001	Loads the ID register with the vendor ID code and places the register between TDI and TDO. This operation does not affect SRAM operations.
SAMPLE Z	010	Captures I/O ring contents. Places the boundary scan register between TDI and TDO. Forces all SRAM output drivers to a high Z state.
RESERVED	011	Do Not Use: This instruction is reserved for future use.
SAMPLE/PRELOAD	100	Captures I/O ring contents. Places the boundary scan register between TDI and TDO. Does not affect SRAM operation.
RESERVED	101	Do Not Use: This instruction is reserved for future use.
RESERVED	110	Do Not Use: This instruction is reserved for future use.
BYPASS	111	Places the bypass register between TDI and TDO. This operation does not affect SRAM operations.

## Boundary Scan Order

165-ball FBGA [22, 23]

Bit #	Ball ID	Bit #	Ball ID	Bit #	Ball ID
1	N6	31	D10	61	G1
2	N7	32	C11	62	D2
3	N10	33	A11	63	E2
4	P11	34	B11	64	F2
5	P8	35	A10	65	G2
6	R8	36	B10	66	H1
7	R9	37	A9	67	H3
8	P9	38	B9	68	J1
9	P10	39	C10	69	K1
10	R10	40	A8	70	L1
11	R11	41	B8	71	M1
12	H11	42	A7	72	J2
13	N11	43	B7	73	K2
14	M11	44	B6	74	L2
15	L11	45	A6	75	M2
16	K11	46	B5	76	N1
17	J11	47	A5	77	N2
18	M10	48	A4	78	P1
19	L10	49	B4	79	R1
20	K10	50	B3	80	R2
21	J10	51	A3	81	P3
22	H9	52	A2	82	R3
23	H10	53	B2	83	P2
24	G11	54	C2	84	R4
25	F11	55	B1	85	P4
26	E11	56	A1	86	N5
27	D11	57	C1	87	P6
28	G10	58	D1	88	R6
29	F10	59	E1	89	Internal
30	E10	60	F1		

**Notes**

- 22. Balls which are NC (No Connect) are pre-set LOW.
- 23. Bit# 89 is pre-set HIGH.

## Maximum Ratings

Exceeding maximum ratings may shorten the useful life of the device. User guidelines are not tested.

Storage temperature ..... -65 °C to +150 °C  
 Ambient temperature with power applied ..... -55 °C to +125 °C  
 Supply voltage on V<sub>DD</sub> relative to GND ..... -0.5 V to +3.6 V  
 Supply voltage on V<sub>DDQ</sub> relative to GND ..... -0.5 V to +V<sub>DD</sub>  
 DC to outputs in tri-state ..... -0.5 V to V<sub>DDQ</sub> + 0.5 V

DC input voltage ..... -0.5 V to V<sub>DD</sub> + 0.5 V  
 Current into outputs (LOW) ..... 20 mA  
 Static discharge voltage (per MIL-STD-883, method 3015) ..... > 2001 V  
 Latch-up current ..... > 200 mA

## Operating Range

Range	Ambient Temperature	V <sub>DD</sub> /V <sub>DDQ</sub>
Commercial	0 °C to +70 °C	2.5 V ± 5%

## Electrical Characteristics

Over the Operating Range

Parameter [24, 25]	Description	Test Conditions	Min	Max	Unit	
V <sub>DD</sub>	Power supply voltage		2.375	2.625	V	
V <sub>DDQ</sub>	I/O supply voltage	for 2.5 V I/O	2.375	V <sub>DD</sub>	V	
V <sub>OH</sub>	Output HIGH voltage	for 2.5 V I/O, I <sub>OH</sub> = -1.0 mA	2.0	-	V	
V <sub>OL</sub>	Output LOW voltage	for 2.5 V I/O, I <sub>OL</sub> = 1.0 mA	-	0.4	V	
V <sub>IH</sub>	Input HIGH voltage [26]	for 2.5 V I/O	1.7	V <sub>DD</sub> + 0.3 V	V	
V <sub>IL</sub>	Input LOW voltage [26]	for 2.5 V I/O	-0.3	0.7	V	
I <sub>X</sub>	Input leakage current except ZZ and MODE	GND ≤ V <sub>I</sub> ≤ V <sub>DDQ</sub>	-5	5	μA	
		Input current of MODE	Input = V <sub>SS</sub>	-30	-	μA
		Input current of MODE	Input = V <sub>DD</sub>	-	5	μA
		Input current of ZZ	Input = V <sub>SS</sub>	-5	-	μA
I <sub>OZ</sub>	Output leakage current	GND ≤ V <sub>I</sub> ≤ V <sub>DD</sub> , output disabled	-5	5	μA	
I <sub>DD</sub>	V <sub>DD</sub> operating supply	V <sub>DD</sub> = Max, I <sub>OUT</sub> = 0 mA, f = f <sub>MAX</sub> = 1/t <sub>CYC</sub>	5.0-ns cycle, 200 MHz	-	300	mA
		6.0-ns cycle, 167 MHz	-	275	mA	
I <sub>SB1</sub>	Automatic CE power-down current – TTL inputs	Max. V <sub>DD</sub> , device deselected, V <sub>IN</sub> ≥ V <sub>IH</sub> or V <sub>IN</sub> ≤ V <sub>IL</sub> , f = f <sub>MAX</sub> = 1/t <sub>CYC</sub>	5.0-ns cycle, 200 MHz	-	150	mA
			6.0-ns cycle, 167 MHz	-	140	mA
I <sub>SB2</sub>	Automatic CE power-down current – CMOS inputs	Max. V <sub>DD</sub> , device deselected, V <sub>IN</sub> ≤ 0.3 V or V <sub>IN</sub> ≥ V <sub>DDQ</sub> - 0.3 V, f = 0	All speed grades	-	70	mA
I <sub>SB3</sub>	Automatic CE power-down current – CMOS Inputs	Max. V <sub>DD</sub> , device deselected, V <sub>IN</sub> ≤ 0.3 V or V <sub>IN</sub> ≥ V <sub>DDQ</sub> - 0.3 V, f = f <sub>MAX</sub> = 1/t <sub>CYC</sub>	5.0-ns cycle, 200 MHz	-	130	mA
			6.0-ns cycle, 167 MHz	-	125	mA
I <sub>SB4</sub>	Automatic CE power-down current—TTL Inputs	Max. V <sub>DD</sub> , device deselected, V <sub>IN</sub> ≥ V <sub>IH</sub> or V <sub>IN</sub> ≤ V <sub>IL</sub> , f = 0	All speed grades	-	80	mA

### Notes

24. Overshoot: V<sub>IH(AC)</sub> < V<sub>DD</sub> + 1.5 V (Pulse width less than t<sub>CYC</sub>/2), undershoot: V<sub>IL(AC)</sub> > -2 V (Pulse width less than t<sub>CYC</sub>/2).  
 25. T<sub>Power-up</sub>: Assumes a linear ramp from 0 V to V<sub>DD(min)</sub> within 200 ms. During this time V<sub>IH</sub> < V<sub>DD</sub> and V<sub>DDQ</sub> ≤ V<sub>DD</sub>.  
 26. Tested initially and after any design or process change that may affect these parameters.

### Capacitance

Parameter [27]	Description	Test Conditions	100-pin TQFP Package	165-ball FBGA Package	Unit
$C_{IN}$	Input capacitance	$T_A = 25\text{ }^\circ\text{C}$ , $f = 1\text{ MHz}$ , $V_{DD} = 2.5\text{ V}$ , $V_{DDQ} = 2.5\text{ V}$	5	9	pF
$C_{CLK}$	Clock input capacitance		5	9	pF
$C_{I/O}$	Input/output capacitance		5	9	pF

### Thermal Resistance

Parameter [27]	Description	Test Conditions	100-pin TQFP Package	165-ball FBGA Package	Unit
$\Theta_{JA}$	Thermal resistance (junction to ambient)	Test conditions follow standard test methods and procedures for measuring thermal impedance, per EIA/JESD51.	28.66	20.7	$^\circ\text{C/W}$
$\Theta_{JC}$	Thermal resistance (junction to case)		4.08	4.0	$^\circ\text{C/W}$

### AC Test Loads and Waveforms

Figure 4. AC Test Loads and Waveforms

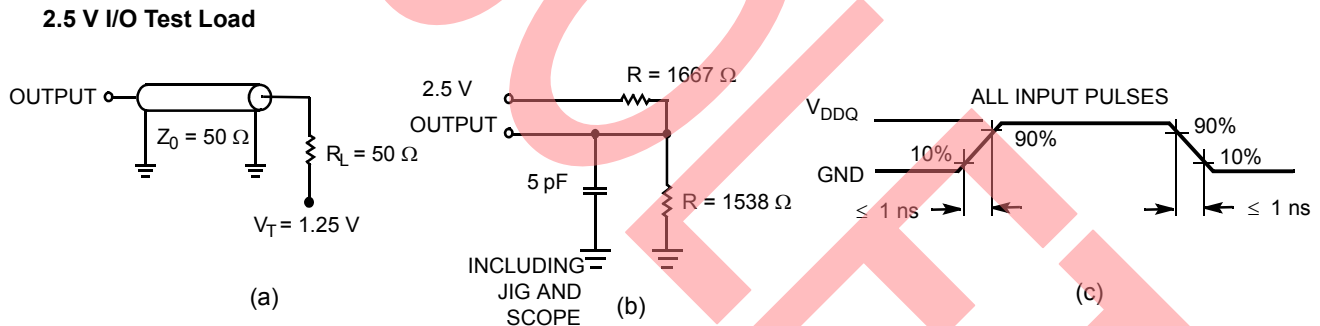

**Note**

27. Tested initially and after any design or process change that may affect these parameters.

## Switching Characteristics

Over the Operating Range

Parameter [28, 29]	Description	-200		-167		Unit
		Min	Max	Min	Max	
$t_{Power}^{[30]}$	$V_{CC}(\text{typical})$ to the first access read or write	1	–	1	–	ms
<b>Clock</b>						
$t_{CYC}$	Clock cycle time	5	–	6	–	ns
$F_{MAX}$	Maximum operating frequency	–	200	–	167	MHz
$t_{CH}$	Clock HIGH	2.0	–	2.2	–	ns
$t_{CL}$	Clock LOW	2.0	–	2.2	–	ns
<b>Output Times</b>						
$t_{CO}$	Data output valid after CLK rise	–	3.0	–	3.4	ns
$t_{EOV}$	$\overline{OE}$ LOW to output valid	–	3.0	–	3.4	ns
$t_{DOH}$	Data output hold after CLK rise	1.3	–	1.3	–	ns
$t_{CHZ}$	Clock to high Z [31, 32, 33]	–	3.0	–	3.4	ns
$t_{CLZ}$	Clock to low Z [31, 32, 33]	1.3	–	1.3	–	ns
$t_{EOHZ}$	$\overline{OE}$ HIGH to output high Z [31, 32, 33]	–	3.0	–	3.4	ns
$t_{EOLZ}$	$\overline{OE}$ LOW to output low Z [31, 32, 33]	0	–	0	–	ns
<b>Set-up Times</b>						
$t_{AS}$	Address set-up before CLK rise	1.4	–	1.5	–	ns
$t_{DS}$	Data input set-up before CLK rise	1.4	–	1.5	–	ns
$t_{CENS}$	$\overline{CEN}$ set-up before CLK rise	1.4	–	1.5	–	ns
$t_{WES}$	$\overline{WE}$ , $\overline{BW}_x$ set-up before CLK rise	1.4	–	1.5	–	ns
$t_{ALS}$	$\overline{ADV}/\overline{LD}$ set-up before CLK rise	1.4	–	1.5	–	ns
$t_{CES}$	Chip select set-up	1.4	–	1.5	–	ns
<b>Hold Times</b>						
$t_{AH}$	Address hold after CLK rise	0.4	–	0.5	–	ns
$t_{DH}$	Data input hold after CLK rise	0.4	–	0.5	–	ns
$t_{CENH}$	$\overline{CEN}$ hold after CLK rise	0.4	–	0.5	–	ns
$t_{WEH}$	$\overline{WE}$ , $\overline{BW}_x$ hold after CLK rise	0.4	–	0.5	–	ns
$t_{ALH}$	$\overline{ADV}/\overline{LD}$ hold after CLK rise	0.4	–	0.5	–	ns
$t_{CEH}$	Chip select hold after CLK rise	0.4	–	0.5	–	ns

### Notes

28. Timing reference 1.25 V when  $V_{DDQ} = 2.5$  V.

29. Test conditions shown in (a) of Figure 4 on page 22 unless otherwise noted.

30. This part has a voltage regulator internally;  $t_{Power}$  is the time power needs to be supplied above  $V_{DD}(\text{minimum})$  initially, before a read or write operation can be initiated.

31.  $t_{CHZ}$ ,  $t_{CLZ}$ ,  $t_{EOLZ}$ , and  $t_{EOHZ}$  are specified with AC test conditions shown in (b) of Figure 4 on page 22. Transition is measured  $\pm 200$  mV from steady-state voltage.

32. At any given voltage and temperature,  $t_{EOHZ}$  is less than  $t_{EOLZ}$  and  $t_{CHZ}$  is less than  $t_{CLZ}$  to eliminate bus contention between SRAMs when sharing the same data bus. These specifications do not imply a bus contention condition, but reflect parameters guaranteed over worst case user conditions. Device is designed to achieve high Z prior to low Z under the same system conditions.

33. This parameter is sampled and not 100% tested.

## Switching Waveforms

Figure 5. Read/Write Cycle Timing [34, 35, 36]

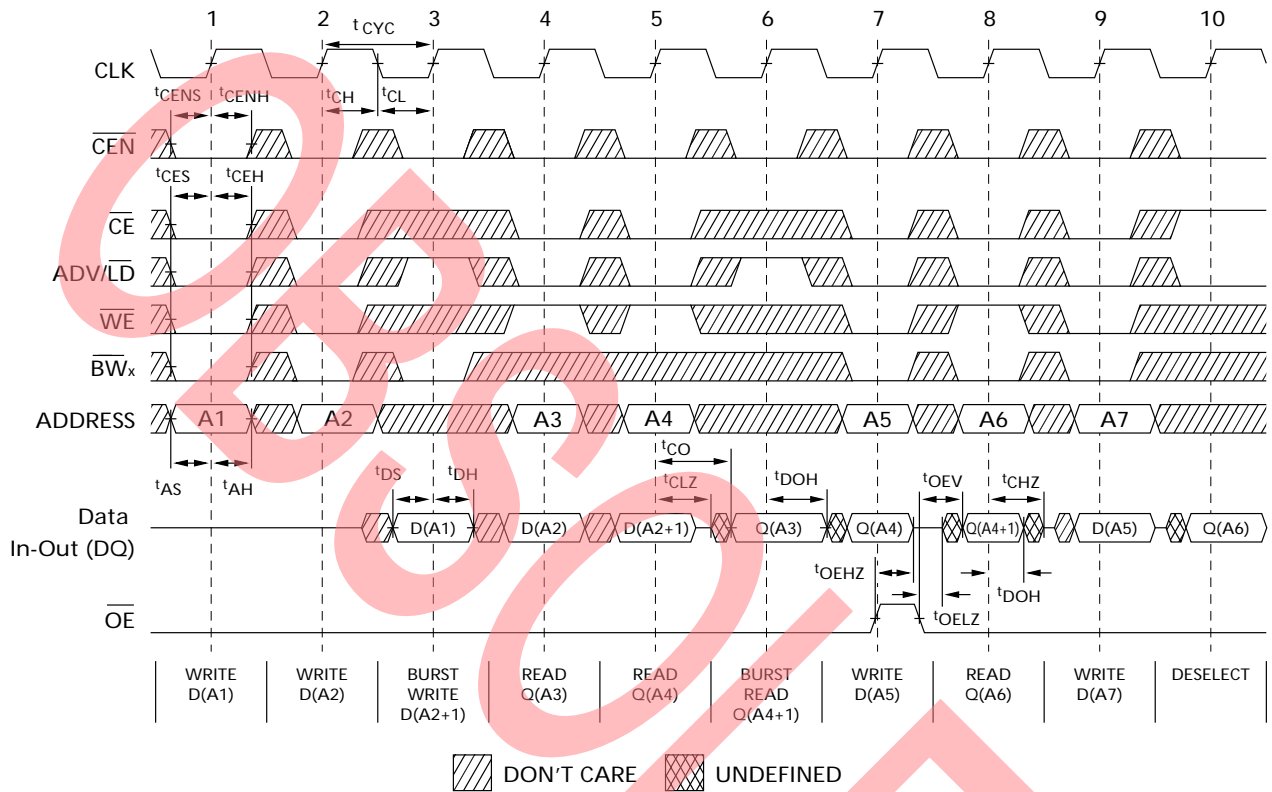

### Notes

34. For this waveform ZZ is tied LOW.

35. When  $\overline{CE}$  is LOW,  $\overline{CE}_1$  is LOW,  $\overline{CE}_2$  is HIGH and  $\overline{CE}_3$  is LOW. When  $\overline{CE}$  is HIGH,  $\overline{CE}_1$  is HIGH or  $\overline{CE}_2$  is LOW or  $\overline{CE}_3$  is HIGH.

36. Order of the Burst sequence is determined by the status of the MODE (0 = Linear, 1 = Interleaved). Burst operations are optional.

**Switching Waveforms** (continued)

**Figure 6. NOP, STALL and DESELECT Cycles** [37, 38, 39]

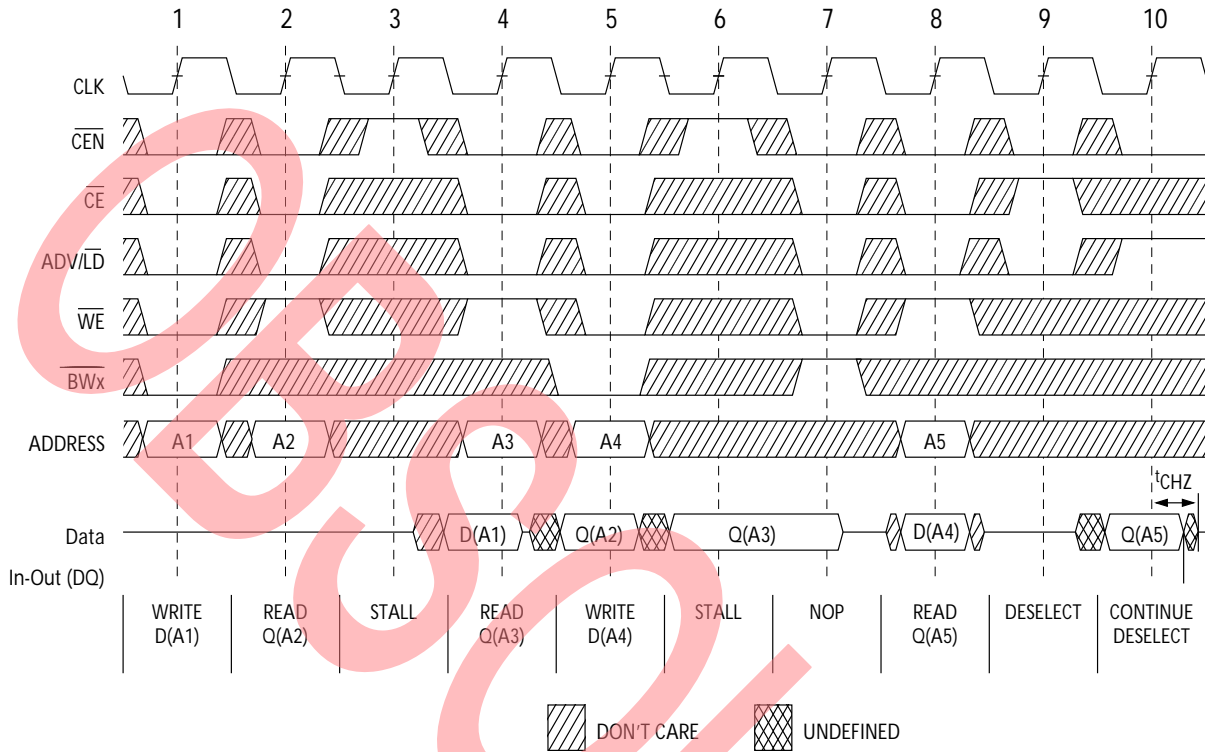

**Figure 7. ZZ Mode Timing** [40, 41]

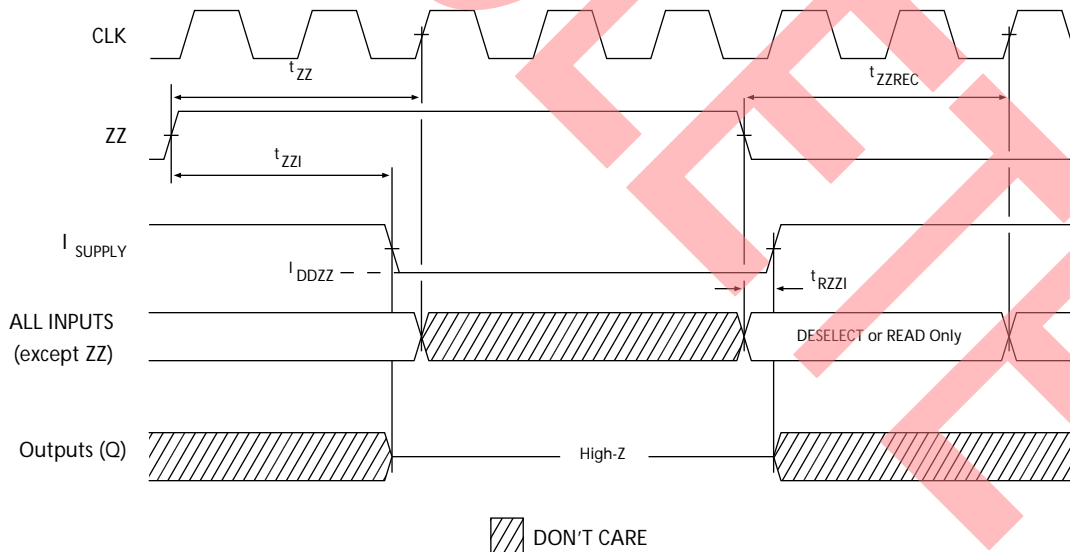

**Notes**

- 37. For this waveform ZZ is tied LOW.
- 38. When  $\overline{CE}$  is LOW,  $\overline{CE}_1$  is LOW,  $CE_2$  is HIGH and  $\overline{CE}_3$  is LOW. When  $\overline{CE}$  is HIGH,  $\overline{CE}_1$  is HIGH or  $CE_2$  is LOW or  $\overline{CE}_3$  is HIGH.
- 39. The Ignore Clock Edge or Stall cycle (Clock 3) illustrated CEN being used to create a pause. A write is not performed during this cycle.
- 40. Device must be deselected when entering ZZ mode. See cycle description table for all possible signal conditions to deselect the device.
- 41. I/Os are in high Z when exiting ZZ sleep mode.

## Ordering Information

Cypress offers other versions of this type of product in different configurations and features. The following table contains only the list of parts that are currently available.

For a complete listing of all options, visit the Cypress website at [www.cypress.com](http://www.cypress.com) and refer to the product summary page at <http://www.cypress.com/products>, or contact your local sales representative.

Cypress maintains a worldwide network of offices, solution centers, manufacturer's representatives and distributors. To find the office closest to you, visit us at <http://www.cypress.com/go/datasheet/offices>.

Speed (MHz)	Ordering Code	Package Diagram	Part and Package Type	Operating Range
167	CY7C1370DV25-167AXC	51-85050	100-pin TQFP (14 × 20 × 1.4 mm) Pb-free	Commercial
	CY7C1372DV25-167AXC			
	CY7C1370DV25-167BZC	51-85180	165-ball FBGA (13 × 15 × 1.4 mm)	
200	CY7C1370DV25-200AXC	51-85050	100-pin TQFP (14 × 20 × 1.4 mm) Pb-free	Commercial
	CY7C1370DV25-200BZC	51-85180	165-ball FBGA (13 × 15 × 1.4 mm)	

### Ordering Code Definitions

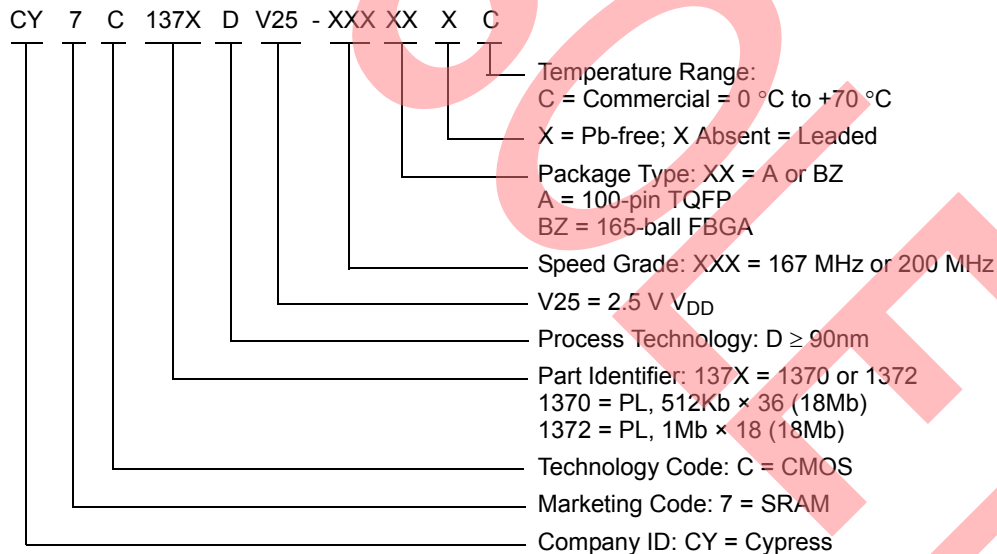

**Package Diagrams**

**Figure 8. 100-pin TQFP (14 × 20 × 1.4 mm) A100RA Package Outline, 51-85050**

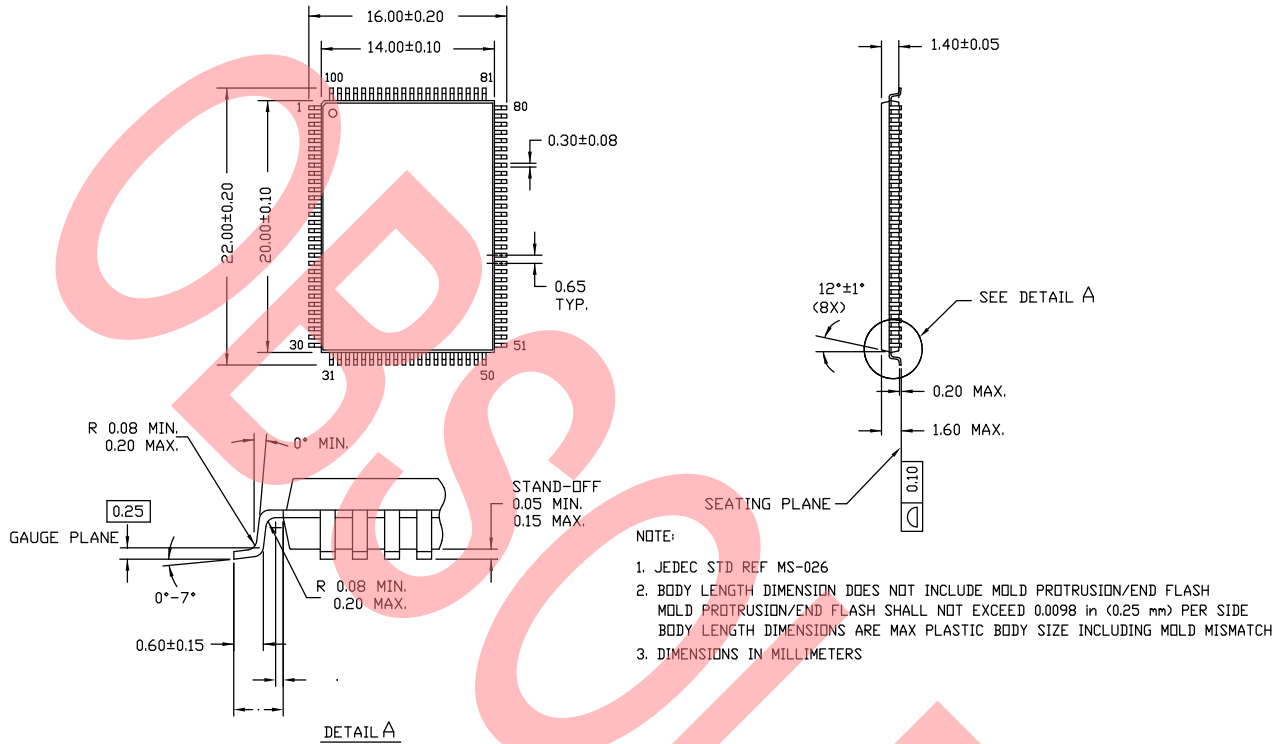

51-85050 \*E

**Package Diagrams** (continued)

**Figure 9. 165-ball FBGA (13 × 15 × 1.4 mm) BB165D/BW165D (0.5 Ball Diameter) Package Outline, 51-85180**

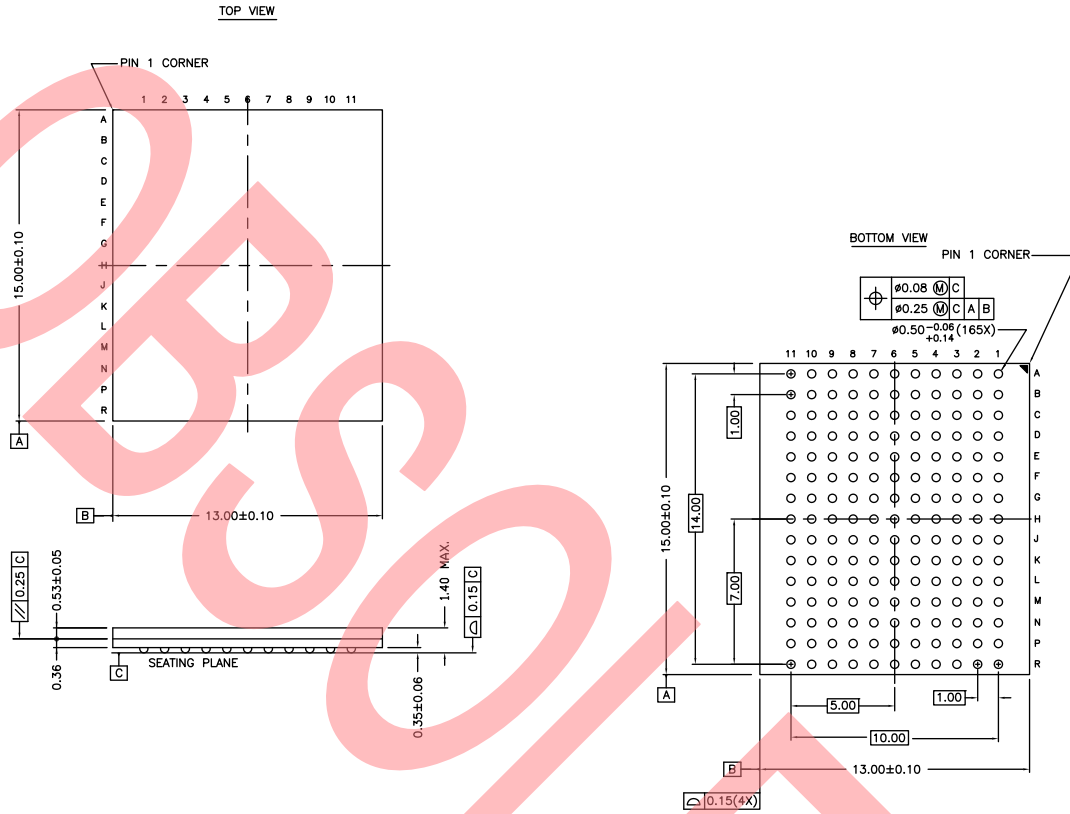

NOTES :

- SOLDER PAD TYPE : NON-SOLDER MASK DEFINED (NSMD)
- JEDEC REFERENCE : MO-216 / ISSUE E
- PACKAGE CODE : BB0AC/BW0AC
- PACKAGE WEIGHT : SEE CYPRESS PACKAGE MATERIAL DECLARATION DATASHEET (PMDD) POSTED ON THE CYPRESS WEB.

51-85180 \*F

## Acronyms

Acronym	Description
CE	Chip Enable
$\overline{\text{CEN}}$	Clock Enable
CMOS	Complementary Metal Oxide Semiconductor
EIA	Electronic Industries Alliance
FBGA	Fine-Pitch Ball Grid Array
I/O	Input/Output
JEDEC	Joint Electron Devices Engineering Council
JTAG	Joint Test Action Group
LSB	Least Significant Bit
MSB	Most Significant Bit
NoBL	No Bus Latency
$\overline{\text{OE}}$	Output Enable
SRAM	Static Random Access Memory
TAP	Test Access Port
TCK	Test Clock
TDI	Test Data-In
TDO	Test Data-Out
TMS	Test Mode Select
TQFP	Thin Quad Flat Pack
TTL	Transistor-Transistor Logic
$\overline{\text{WE}}$	Write Enable

## Document Conventions

### Units of Measure

Symbol	Unit of Measure
°C	degree Celsius
MHz	megahertz
μA	microampere
mA	milliampere
mm	millimeter
ms	millisecond
mV	millivolt
ns	nanosecond
Ω	ohm
%	percent
pF	picofarad
V	volt
W	watt

## Errata

This section describes the Ram9 NoBL ZZ pin and JTAG issues. Details include trigger conditions, the devices affected, proposed workaround and silicon revision applicability. Please contact your local Cypress sales representative if you have further questions.

### Part Numbers Affected

Density & Revision	Package Type	Operating Range
18Mb-Ram9 NoBL SRAMs: CY7C137*DV25	100-pin TQFP	Commercial
	165-ball FBGA	

### Product Status

All of the devices in the Ram9 18Mb NoBL family are qualified and available in production quantities.

### Ram9 NoBL ZZ Pin & JTAG Issues Errata Summary

The following table defines the errata applicable to available Ram9 18Mb NoBL family devices.

Item	Issues	Description	Device	Fix Status
1.	ZZ Pin	When asserted HIGH, the ZZ pin places device in a "sleep" condition with data integrity preserved. The ZZ pin currently does not have an internal pull-down resistor and hence cannot be left floating externally by the user during normal mode of operation.	18M-Ram9 (90nm)	For the 18M Ram9 (90 nm) devices, there is no plan to fix this issue.
2.	JTAG Functionality	During JTAG test mode, the Boundary scan circuitry does not perform as described in the datasheet. However, it is possible to perform the JTAG test with these devices in "BYPASS mode".	18M-Ram9 (90nm)	This issue will be fixed in the new revision, which use the 65 nm technology. Please contact your local sales rep for availability.

## 1. ZZ Pin Issue

### ■ PROBLEM DEFINITION

The problem occurs only when the device is operated in the normal mode with ZZ pin left floating. The ZZ pin on the SRAM device does not have an internal pull-down resistor. Switching noise in the system may cause the SRAM to recognize a HIGH on the ZZ input, which may cause the SRAM to enter sleep mode. This could result in incorrect or undesirable operation of the SRAM.

### ■ TRIGGER CONDITIONS

Device operated with ZZ pin left floating.

### ■ SCOPE OF IMPACT

When the ZZ pin is left floating, the device delivers incorrect data.

### ■ WORKAROUND

Tie the ZZ pin externally to ground.

### ■ FIX STATUS

For the 18M Ram9 (90 nm) devices, there is no plan to fix this issue.

## 2. JTAG Functionality

### ■ PROBLEM DEFINITION

The problem occurs only when the device is operated in the JTAG test mode. During this mode, the JTAG circuitry can perform incorrectly by delivering the incorrect data or the incorrect scan chain length.

### ■ TRIGGER CONDITIONS

Several conditions can trigger this failure mode.

1. The device can deliver an incorrect length scan chain when operating in JTAG mode.
2. Some Byte Write inputs only recognize a logic HIGH level when in JTAG mode.
3. Incorrect JTAG data can be read from the device when the ZZ input is tied HIGH during JTAG operation.

### ■ SCOPE OF IMPACT

The device fails for JTAG test. This does not impact the normal functionality of the device.

### ■ WORKAROUND

1. Perform JTAG testing with these devices in "BYPASS mode".
2. Do not use JTAG test.

### ■ FIX STATUS

This issue will be fixed in the new revision, which use the 65 nm technology. Please contact your local sales rep for availability

## Document History Page

Document Title: CY7C1370DV25/CY7C1372DV25, 18-Mbit (512K × 36/1M × 18) Pipelined SRAM with NoBL™ Architecture				
Document Number: 38-05558				
Rev.	ECN No.	Issue Date	Orig. of Change	Description of Change
**	254509	See ECN	RKF	New data sheet.
*A	288531	See ECN	SYT	Updated <a href="#">Selection Guide</a> (Removed 225 MHz frequency related information). Updated <a href="#">IEEE 1149.1 Serial Boundary Scan (JTAG [18])</a> (Edited description for non-compliance with 1149.1). Updated <a href="#">Electrical Characteristics</a> (Removed 225 MHz frequency related information). Updated <a href="#">Switching Characteristics</a> (Removed 225 MHz frequency related information). Updated <a href="#">Ordering Information</a> (Added Pb-free information for 100-pin TQFP, 119-ball BGA and 165-ball FBGA package) and added comment for 'Pb-free BG packages availability' below the Ordering Information.
*B	326078	See ECN	PCI	Updated <a href="#">Pin Configurations</a> (Address expansion pins/balls in the pinouts for all packages are modified as per JEDEC standard). Updated <a href="#">IEEE 1149.1 Serial Boundary Scan (JTAG [18])</a> (Updated <a href="#">TAP Instruction Set</a> (Updated <a href="#">OVERVIEW</a> (description), updated <a href="#">EXTEST</a> (description), added <a href="#">EXTEST Output Bus Tri-State</a> )). Updated <a href="#">Electrical Characteristics</a> (Modified Test Conditions for $V_{OL}$ , $V_{OH}$ parameters). Updated <a href="#">Thermal Resistance</a> (Changed $\theta_{JA}$ and $\theta_{JC}$ for 100-pin TQFP Package from 31 and 6 °C/W to 28.66 and 4.08 °C/W respectively, changed $\theta_{JA}$ and $\theta_{JC}$ for 119-ball BGA Package from 45 and 7 °C/W to 23.8 and 6.2 °C/W respectively, changed $\theta_{JA}$ and $\theta_{JC}$ for FBGA Package from 46 and 3 °C/W to 20.7 and 4.0 °C/W respectively). Updated <a href="#">Ordering Information</a> (Updated part numbers) and removed comment for 'Pb-free BG packages availability' below the Ordering Information
*C	418125	See ECN	NXR	Changed status from Preliminary to Final. Changed address of Cypress Semiconductor Corporation from "3901 North First Street" to "198 Champion Court". Updated <a href="#">Electrical Characteristics</a> (Changed the description of $I_X$ parameter from Input Load Current to Input Leakage Current, changed the minimum and maximum values of $I_X$ parameter (corresponding to Input Current of MODE) from -5 µA and 30 µA to -30 µA and 5 µA, changed the minimum and maximum values of $I_X$ parameter (corresponding to Input current of ZZ) from -30 µA and 5 µA to -5 µA and 30 µA, updated Note 25). Updated <a href="#">Ordering Information</a> (Updated part numbers).
*D	475677	See ECN	VKN	Updated <a href="#">TAP AC Switching Characteristics</a> (Changed minimum values of $t_{TH}$ , and $t_{TL}$ parameters from 25 ns to 20 ns, and maximum value of $t_{TDOV}$ parameter from 5 ns to 10 ns). Updated <a href="#">Maximum Ratings</a> (Added the Maximum Rating for Supply Voltage on $V_{DDQ}$ Relative to GND). Updated <a href="#">Ordering Information</a> (Updated part numbers).
*E	2897278	03/22/2010	NJY	Updated <a href="#">Ordering Information</a> (Removed obsolete part numbers). Updated <a href="#">Package Diagrams</a> .
*F	3031731	09/16/2010	NJY	Updated <a href="#">Ordering Information</a> (Updated part numbers) and added <a href="#">Ordering Code Definitions</a> . Added <a href="#">Acronyms and Units of Measure</a> . Minor edits. Updated to new template.
*G	3050869	10/07/2010	NJY	Updated <a href="#">Ordering Information</a> (Removed CY7C1370DV25-167BZI, CY7C1370DV25-250AXC, and CY7C1370DV25-167AXI).
*H	3067198	10/20/2010	NJY	Updated <a href="#">Ordering Information</a> (Updated part numbers).

Document History Page (continued)

Document Title: CY7C1370DV25/CY7C1372DV25, 18-Mbit (512K × 36/1M × 18) Pipelined SRAM with NoBL™ Architecture				
Document Number: 38-05558				
Rev.	ECN No.	Issue Date	Orig. of Change	Description of Change
*I	3378887	09/21/2011	PRIT	Updated <a href="#">Package Diagrams</a> .
*J	3575766	04/10/2012	NJY / PRIT	Updated <a href="#">Features</a> (Removed 250 MHz frequency related information, removed 119-ball BGA package related information). Updated <a href="#">Selection Guide</a> (Removed 250 MHz frequency related information). Updated <a href="#">Pin Configurations</a> (Removed 119-ball BGA package related information). Updated <a href="#">Scan Register Sizes</a> (Removed 119-ball BGA package related information). Removed Boundary Scan Order (Corresponding to 119-ball BGA package). Updated <a href="#">Operating Range</a> (Removed Industrial Temperature Range). Updated <a href="#">Electrical Characteristics</a> (Removed 250 MHz frequency related information). Updated <a href="#">Capacitance</a> (Removed 119-ball BGA package related information). Updated <a href="#">Thermal Resistance</a> (Removed 119-ball BGA package related information). Updated <a href="#">Switching Characteristics</a> (Removed 250 MHz frequency related information). Updated <a href="#">Package Diagrams</a> (Removed 119-ball BGA package related information).
*K	3753130	09/24/2012	PRIT	Updated <a href="#">Package Diagrams</a> (spec 51-85180 (Changed revision from *E to *F)).
*L	3981545	04/25/2013	PRIT	Added <a href="#">Errata</a> .
*M	4070450	07/20/2013	PRIT	Added Errata footnotes (Note 1, 2, 3, 4, 5, 18). Updated <a href="#">Pin Configurations</a> : Added Note 1 and referred the same note in <a href="#">Figure 1</a> . Added Note 2, 3 and referred the same note in <a href="#">Figure 2</a> . Updated <a href="#">Pin Definitions</a> : Added Note 4 and referred the same note in TDO, TDI, TMS, TCK pins. Added Note 5 and referred the same note in ZZ pin. Updated <a href="#">IEEE 1149.1 Serial Boundary Scan (JTAG [18])</a> : Added Note 18 and referred the same note in JTAG in the heading. Updated to new template.
*N	4151890	10/09/2013	PRIT	Updated <a href="#">Errata</a> .
*O	4572829	11/18/2014	PRIT	Updated <a href="#">Functional Description</a> : Added "For a complete list of related documentation, click <a href="#">here</a> ." at the end. Updated <a href="#">Package Diagrams</a> : spec 51-85050 – Changed revision from *D to *E.
*P	5508335	11/03/2016	PRIT	Obsolete document. Completing Sunset Review.

## Sales, Solutions, and Legal Information

### Worldwide Sales and Design Support

Cypress maintains a worldwide network of offices, solution centers, manufacturer's representatives, and distributors. To find the office closest to you, visit us at [Cypress Locations](#).

#### Products

Automotive	<a href="http://cypress.com/go/automotive">cypress.com/go/automotive</a>
Clocks & Buffers	<a href="http://cypress.com/go/clocks">cypress.com/go/clocks</a>
Interface	<a href="http://cypress.com/go/interface">cypress.com/go/interface</a>
Lighting & Power Control	<a href="http://cypress.com/go/powerpsoc">cypress.com/go/powerpsoc</a>
	<a href="http://cypress.com/go/plc">cypress.com/go/plc</a>
Memory	<a href="http://cypress.com/go/memory">cypress.com/go/memory</a>
PSoC	<a href="http://cypress.com/go/psoc">cypress.com/go/psoc</a>
Touch Sensing	<a href="http://cypress.com/go/touch">cypress.com/go/touch</a>
USB Controllers	<a href="http://cypress.com/go/USB">cypress.com/go/USB</a>
Wireless/RF	<a href="http://cypress.com/go/wireless">cypress.com/go/wireless</a>

#### PSoC® Solutions

[psoc.cypress.com/solutions](http://psoc.cypress.com/solutions)  
PSoC 1 | PSoC 3 | PSoC 4 | PSoC 5LP

#### Cypress Developer Community

[Community](#) | [Forums](#) | [Blogs](#) | [Video](#) | [Training](#)

#### Technical Support

[cypress.com/go/support](http://cypress.com/go/support)

© Cypress Semiconductor Corporation, 2004-2016. The information contained herein is subject to change without notice. Cypress Semiconductor Corporation assumes no responsibility for the use of any circuitry other than circuitry embodied in a Cypress product. Nor does it convey or imply any license under patent or other rights. Cypress products are not warranted nor intended to be used for medical, life support, life saving, critical control or safety applications, unless pursuant to an express written agreement with Cypress. Furthermore, Cypress does not authorize its products for use as critical components in life-support systems where a malfunction or failure may reasonably be expected to result in significant injury to the user. The inclusion of Cypress products in life-support systems application implies that the manufacturer assumes all risk of such use and in doing so indemnifies Cypress against all charges.



Any Source Code (software and/or firmware) is owned by Cypress Semiconductor Corporation (Cypress) and is protected by and subject to worldwide patent protection (United States and foreign), United States copyright laws and international treaty provisions. Cypress hereby grants to licensee a personal, non-exclusive, non-transferable license to copy, use, modify, create derivative works of, and compile the Cypress Source Code and derivative works for the sole purpose of creating custom software and or firmware in support of licensee product to be used only in conjunction with a Cypress integrated circuit as specified in the applicable agreement. Any reproduction, modification, translation, compilation, or representation of this Source Code except as specified above is prohibited without the express written permission of Cypress.

Disclaimer: CYPRESS MAKES NO WARRANTY OF ANY KIND, EXPRESS OR IMPLIED, WITH REGARD TO THIS MATERIAL, INCLUDING, BUT NOT LIMITED TO, THE IMPLIED WARRANTIES OF MERCHANTABILITY AND FITNESS FOR A PARTICULAR PURPOSE. Cypress reserves the right to make changes without further notice to the materials described herein. Cypress does not assume any liability arising out of the application or use of any product or circuit described herein. Cypress does not authorize its products for use as critical components in life-support systems where a malfunction or failure may reasonably be expected to result in significant injury to the user. The inclusion of Cypress' product in a life-support systems application implies that the manufacturer assumes all risk of such use and in doing so indemnifies Cypress against all charges.

Use may be limited by and subject to the applicable Cypress software license agreement.

## Looking for pricing, stock, or lifecycle information?

Click below to explore more details on WIN SOURCE:

-  [View CY7C1370DV25-167AXC on WIN SOURCE](#)
-  [Cypress Semiconductor Corp Information](#)

## Optimize Your Supply Chain with WIN SOURCE Solutions

-  Global Sourcing Solution
-  Obsolete Management
-  Cost Control Management
-  Shortage Management
-  Alternative Solution
-  Excess Inventory Management