

# AN7512

## Dual 1-W BTL audio power amplifier

### ■ Overview

The AN7512 is an audio power amplifier IC for stereo system. The BTL (Balanced Transformer-Less) method can provide fewer external parts and more easy design for applications.

### ■ Features

- 1-W output (8  $\Omega$ ) with supply voltage of 5 V
- On-chip standby function
- On-chip volume function

### ■ Applications

- Televisions, audio equipment, personal computers, and active speakers

### ■ Package

- HDIP016-P-300A

### ■ Block Diagram

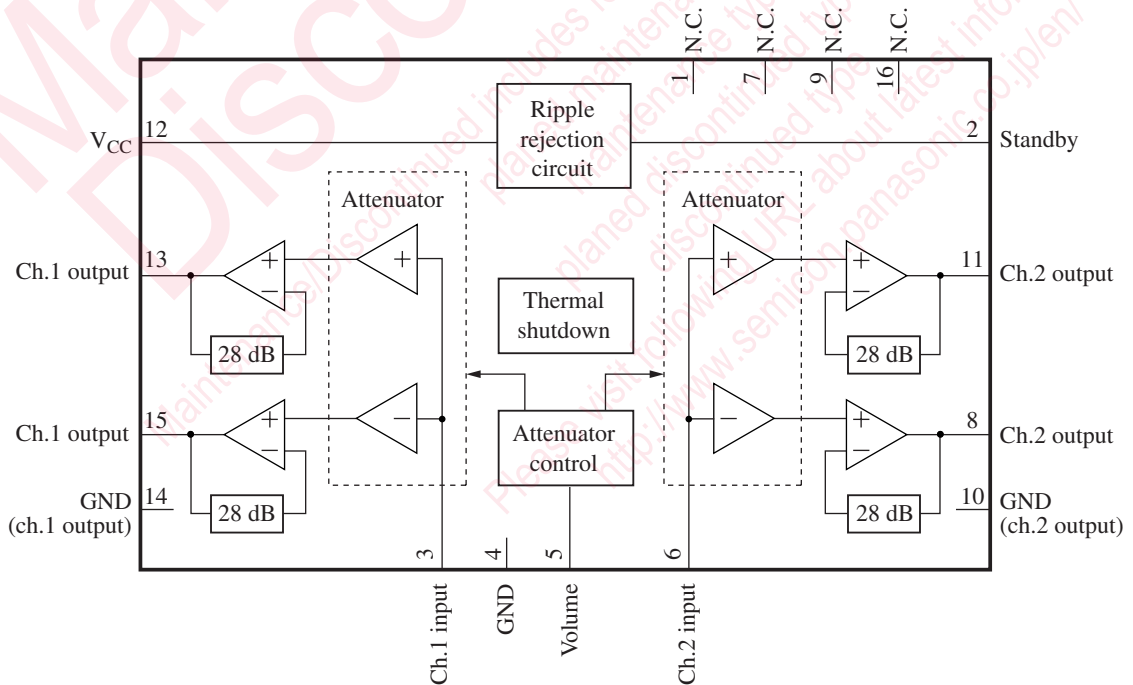

### ■ Pin Descriptions

Pin No.	Description	Pin No.	Description
1	N.C.	9	N.C.
2	Standby (standby state if this pin is open.)	10	Ground (output ch.2)
3	Ch.1 input	11	Ch.2 + output
4	Ground (input)	12	Supply voltage
5	Volume (muting off if this pin is open.)	13	Ch.1 + output
6	Ch.2 input	14	Ground (output ch.1)
7	N.C.	15	Ch.1 – output
8	Ch.2 – output	16	N.C.

Note) Please do not apply voltage or current to the N.C. pin from outside.

### ■ Absolute Maximum Ratings

Parameter	Symbol	Rating	Unit
Supply voltage <sup>*2</sup>	$V_{CC}$	14	V
Supply current	$I_{CC}$	2.0	A
Power dissipation <sup>*3</sup>	$P_D$	1 127	mW
Operating ambient temperature <sup>*1</sup>	$T_{opr}$	-25 to +70	°C
Storage temperature <sup>*1</sup>	$T_{stg}$	-55 to +150	°C

Note) \*1: Except for the operating ambient temperature and storage temperature, all ratings are for  $T_a = 25^\circ\text{C}$ .

\*2: At no signal.

\*3: The power dissipation shown is the value for  $T_a = 70^\circ\text{C}$ .

### ■ Recommended Operating Range

Parameter	Symbol	Range	Unit
Supply voltage	$V_{CC}$	3.5 to 13.5	V

**■ Electrical Characteristics at  $V_{CC} = 5.0 \text{ V}$ ,  $R_L = 8 \Omega$ ,  $f = 1 \text{ kHz}$ ,  $T_a = 25^\circ\text{C} \pm 2^\circ\text{C}$** 

Parameter	Symbol	Conditions	Min	Typ	Max	Unit
Quiescent circuit current	$I_{CQ}$	$V_{IN} = 0 \text{ mV}$ , $\text{Vol.} = 0 \text{ V}$	—	35	100	mA
Standby current	$I_{STB}$	$V_{IN} = 0 \text{ mV}$ , $\text{Vol.} = 0 \text{ V}$	—	1	10	$\mu\text{A}$
Output noise voltage *	$V_{NO}$	$R_g = 10 \text{ k}\Omega$ , $\text{Vol.} = 0 \text{ V}$	—	0.10	0.4	mV[rms]
Voltage gain	$G_V$	$P_O = 0.25 \text{ W}$ , $\text{Vol.} = 1.25 \text{ V}$	31	33	35	dB
Total harmonics distortion	THD	$P_O = 0.25 \text{ W}$ , $\text{Vol.} = 1.25 \text{ V}$	—	0.10	0.5	%
Maximum output power	$P_{O1}$	THD = 10 %, $\text{Vol.} = 1.25 \text{ V}$	0.7	1.0	—	W
Ripple rejection ratio *	RR	$R_g = 10 \text{ k}\Omega$ , $\text{Vol.} = 0 \text{ V}$ , $V_R = 0.5 \text{ V[rms]}$ , $f_R = 120 \text{ Hz}$	30	50	—	dB
Output offset voltage	$V_{OFF}$	$R_g = 10 \text{ k}\Omega$ , $\text{Vol.} = 0 \text{ V}$	-250	0	250	mV
Volume attenuation rate *	Att	$P_O = 0.25 \text{ W}$ , $\text{Vol.} = 0 \text{ V}$	70	85	—	dB
Channel balance 1	CB1	$P_O = 0.25 \text{ W}$ , $\text{Vol.} = 1.25 \text{ V}$	-1	0	1	dB
Channel balance 2	CB2	$P_O = 0.25 \text{ W}$ , $\text{Vol.} = 0.6 \text{ V}$	-3	0	3	dB
Intermediate voltage gain	$G_{VM}$	$P_O = 0.25 \text{ W}$ , $\text{Vol.} = 0.6 \text{ V}$	20.5	23.5	26.5	dB
Channel crosstalk	CT	$P_O = 0.25 \text{ W}$ , $\text{Vol.} = 1.25 \text{ V}$	40	55	—	dB

Note) \*: In measuring, the filter for the range of 15 Hz to 30 kHz (12 dB/OCT) is used.

**■ Terminal Equivalent Circuits**

Pin No.	Pin name	Equivalent circuit	Voltage
1	N.C.	Open	—
2	Standby pin		5 V

■ Terminal Equivalent Circuits (continued)

Pin No.	Pin name	Equivalent circuit	Voltage
3	Ch.1 input pin		1.4 V
4	GND		0 V
5	Volume pin		—
6	Ch.2 input pin		1.4 V
7	N.C.	Open	—

■ Terminal Equivalent Circuits (continued)

Pin No.	Pin name	Equivalent circuit	Voltage
8	Ch.2 - output pin		2.15 V
9	N.C.	Open	—
10	GND		0 V
11	Ch.2 + output pin		2.15 V
12	V <sub>CC</sub>	—	5.0 V
13	Ch.1 + output pin		2.15 V

■ Terminal Equivalent Circuits (continued)

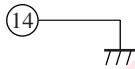
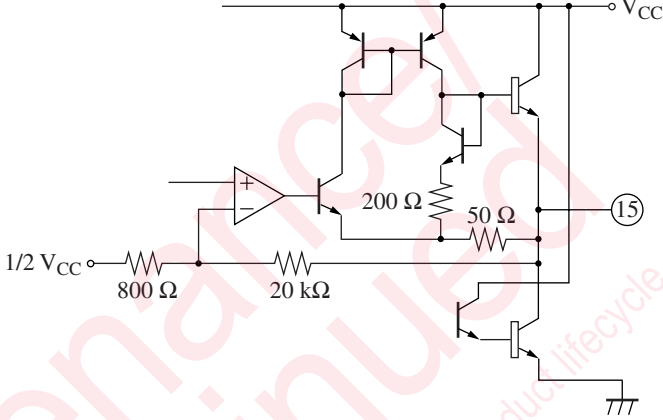
Pin No.	Pin name	Equivalent circuit	Voltage
14	GND		0 V
15	Ch.1 – output pin		2.15 V
16	N.C.	Open	—

■ Usage Notes

- Please avoid the short circuit to  $V_{CC}$ , ground, or load short circuit.
- Please connect the cooling fin with the GND potential.
- The thermal shutdown circuit operates at about  $T_j = 150^\circ\text{C}$ . However, the thermal shutdown circuit is reset automatically if the temperature drops.
- Please carefully design the heat radiation especially when you take out high power at high  $V_{CC}$ .
- Please connect only the ground of signal with the signal GND of the amplifier in the previous stage.

■ Technical Data

- $P_D - T_a$  curve of HDIP016-P-0300

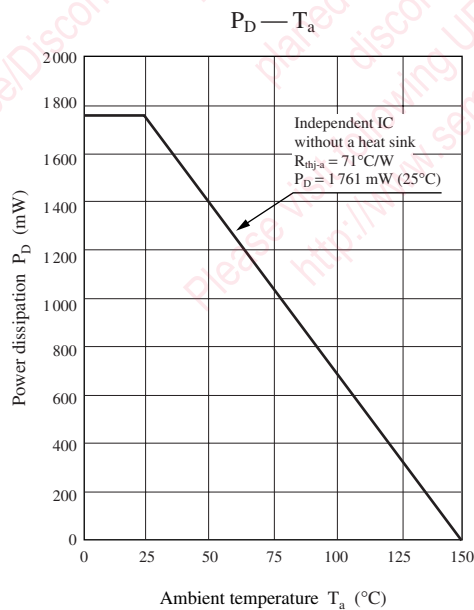

■ Technical Data (continued)

• Main characteristics

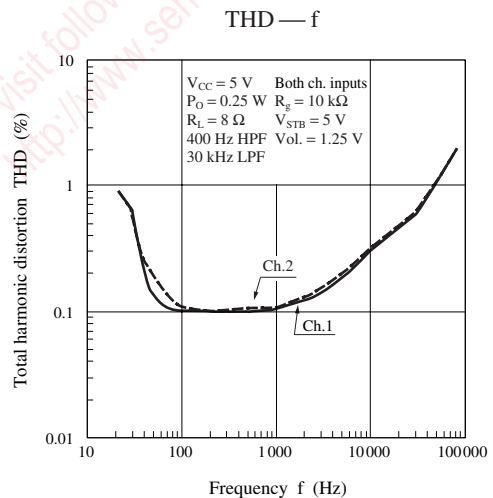
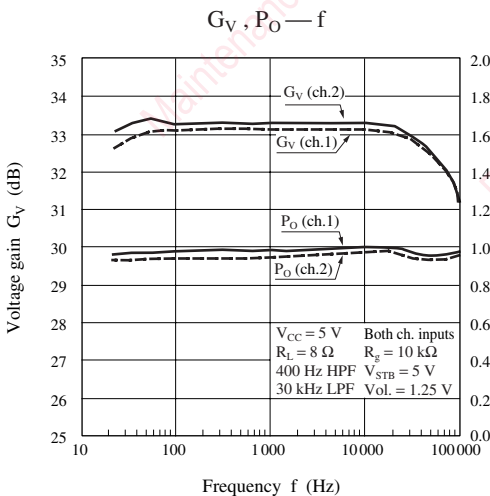
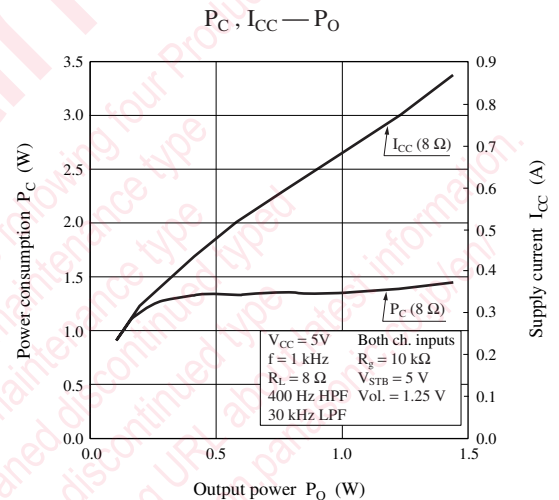
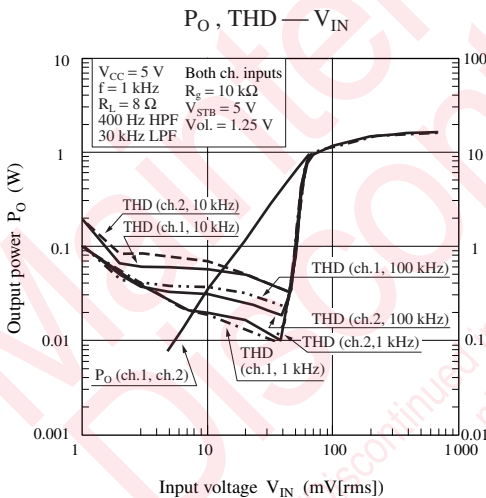
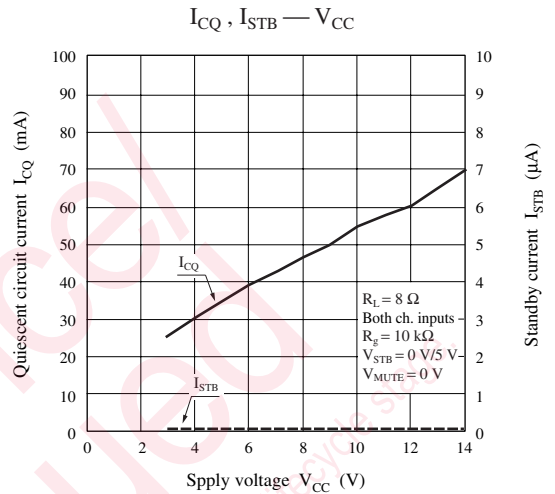
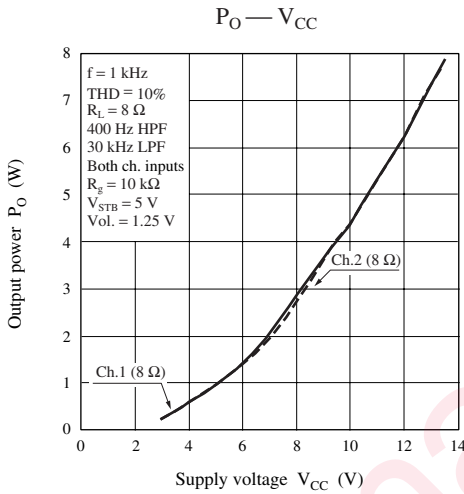

■ Technical Data (continued)

• Main characteristics (continued)

$G_V$ , THD —  $V_{CC}$

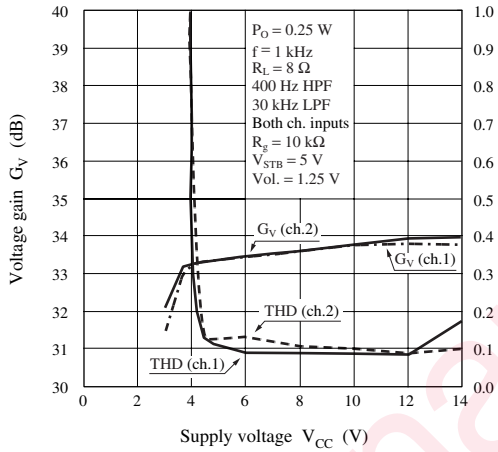

Att — Vol.

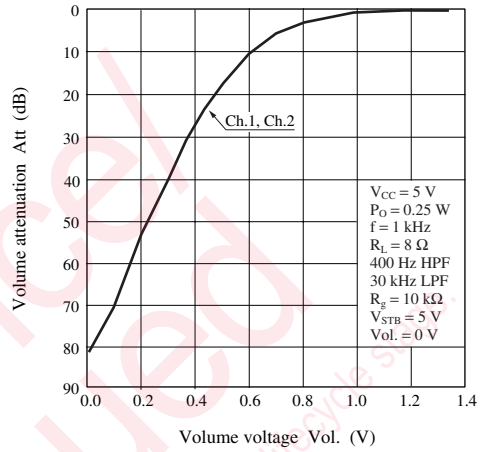

RR —  $V_{RIPPLE}$

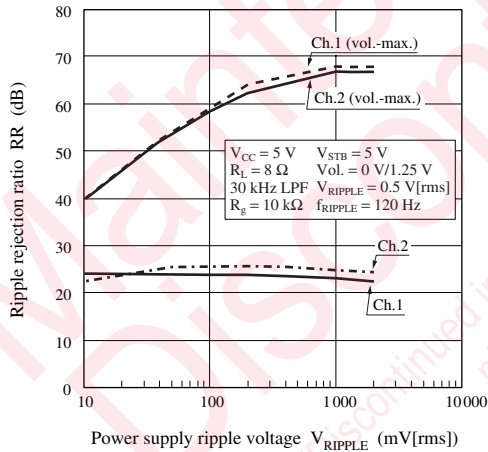

RR —  $f_{RIPPLE}$

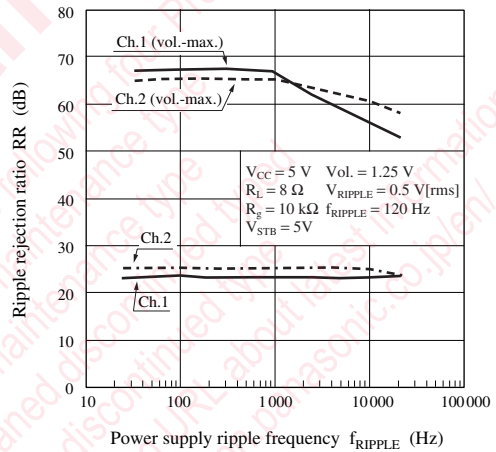

RR —  $V_{CC}$

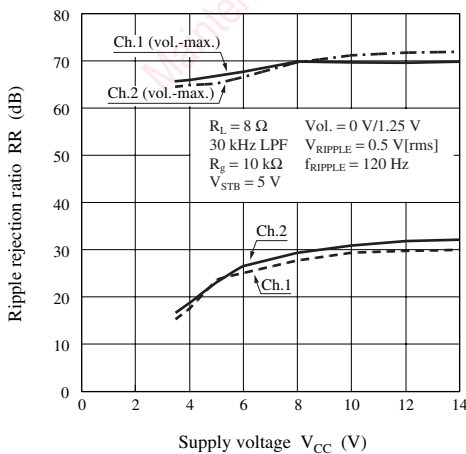

RR — Vol.

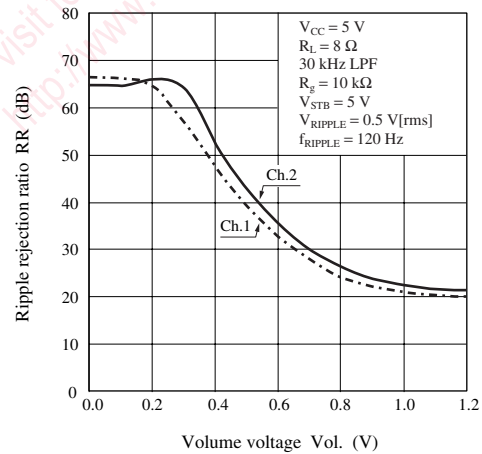

■ Technical Data (continued)

• Main characteristics (continued)

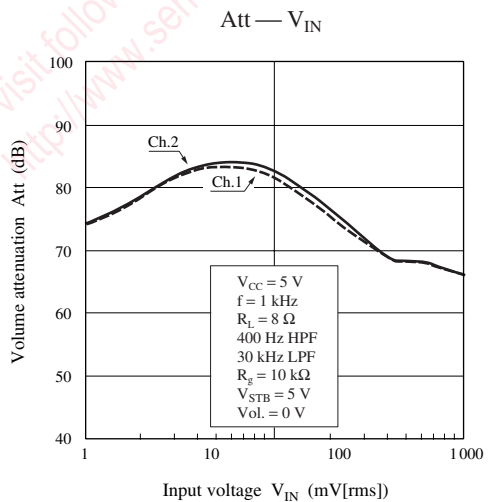
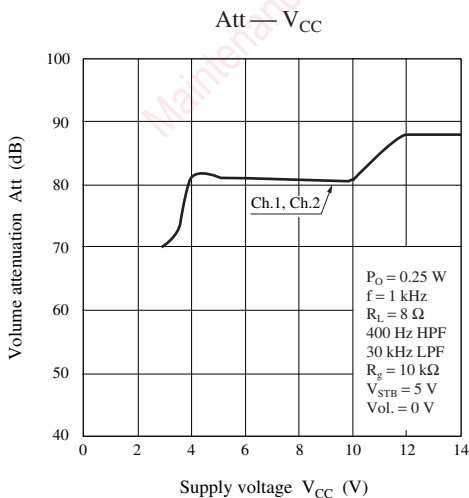
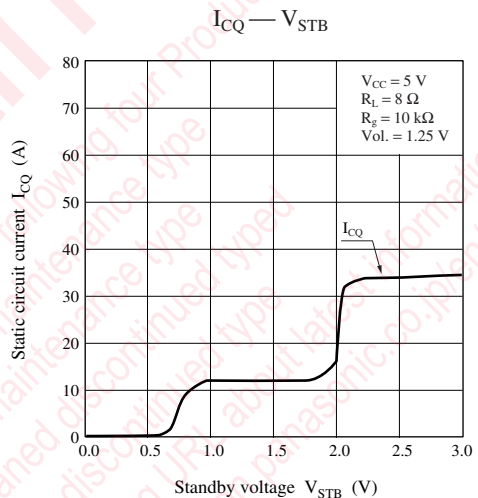
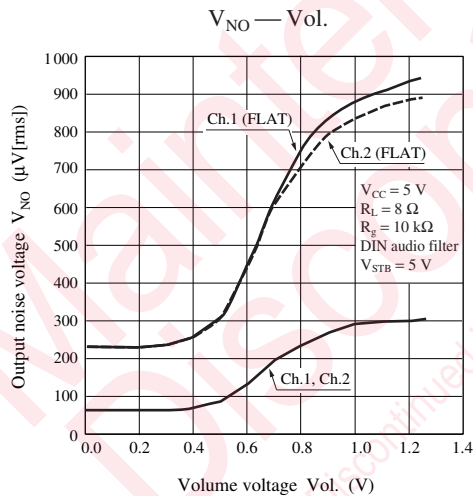
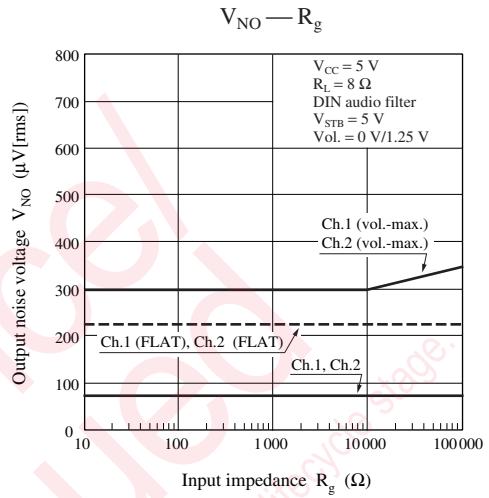
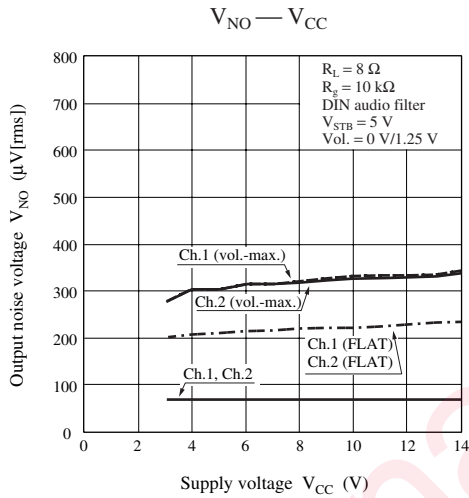

■ Technical Data (continued)

● Main characteristics (continued)

Att — f

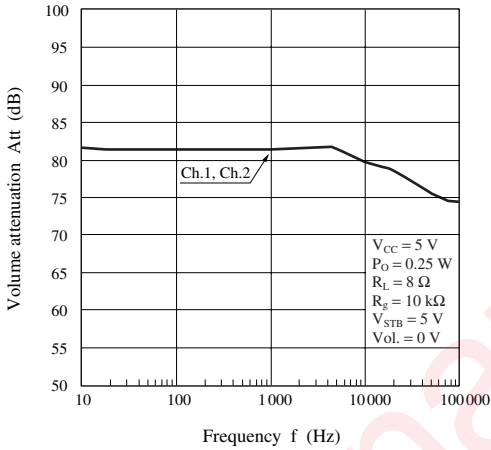

THD — Vol.

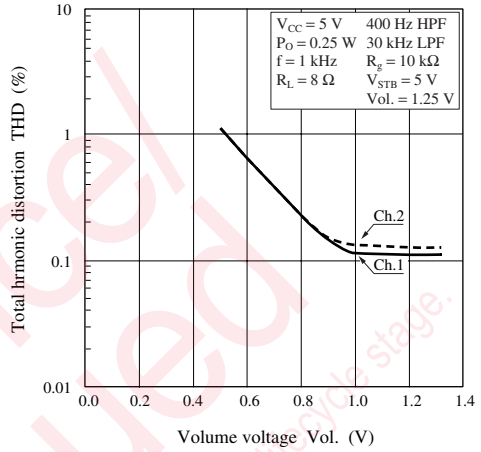

CT —  $V_{CC}$

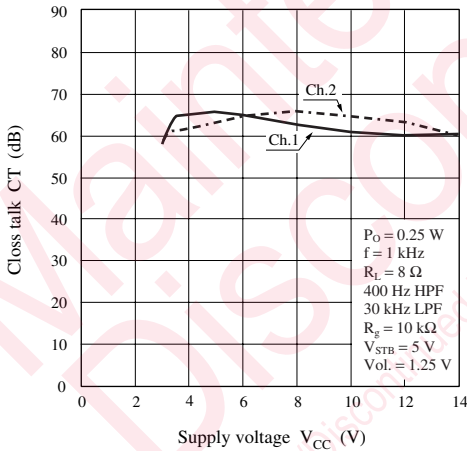

CT —  $V_{IN}$

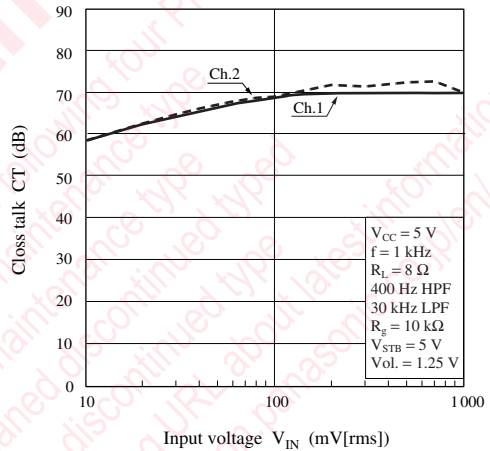

CT — f

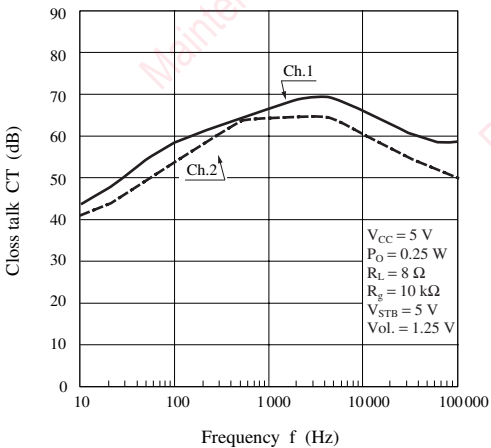

■ Technical Data (continued)

• Example of PCB pattern

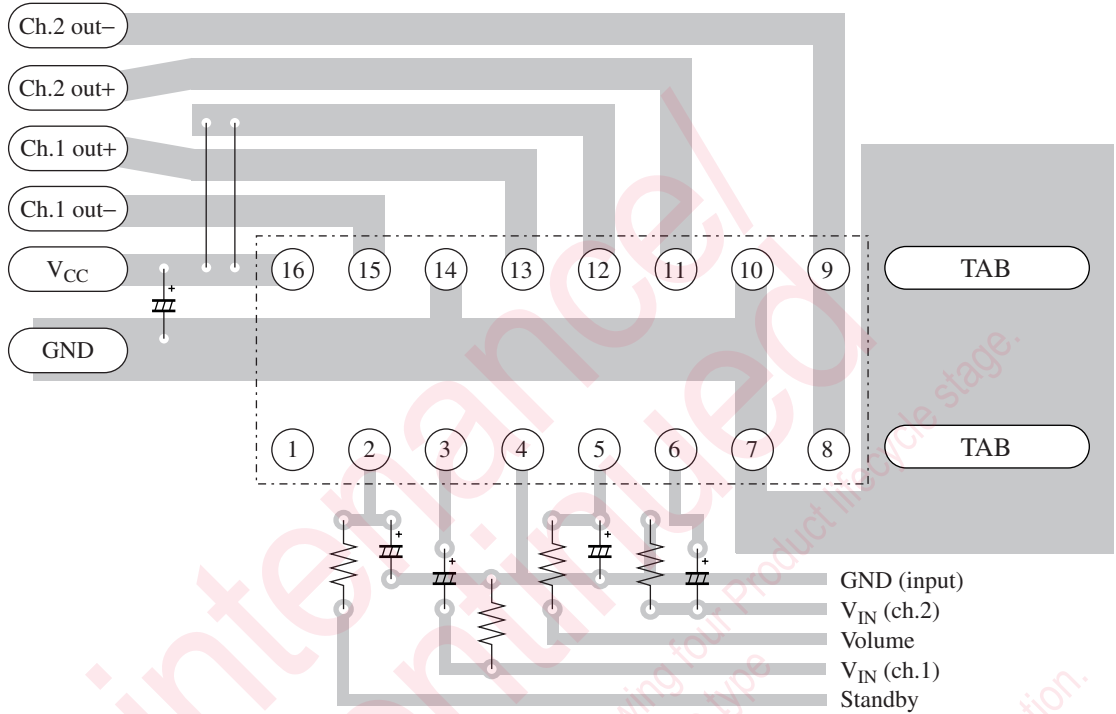

■ Application Circuit Example

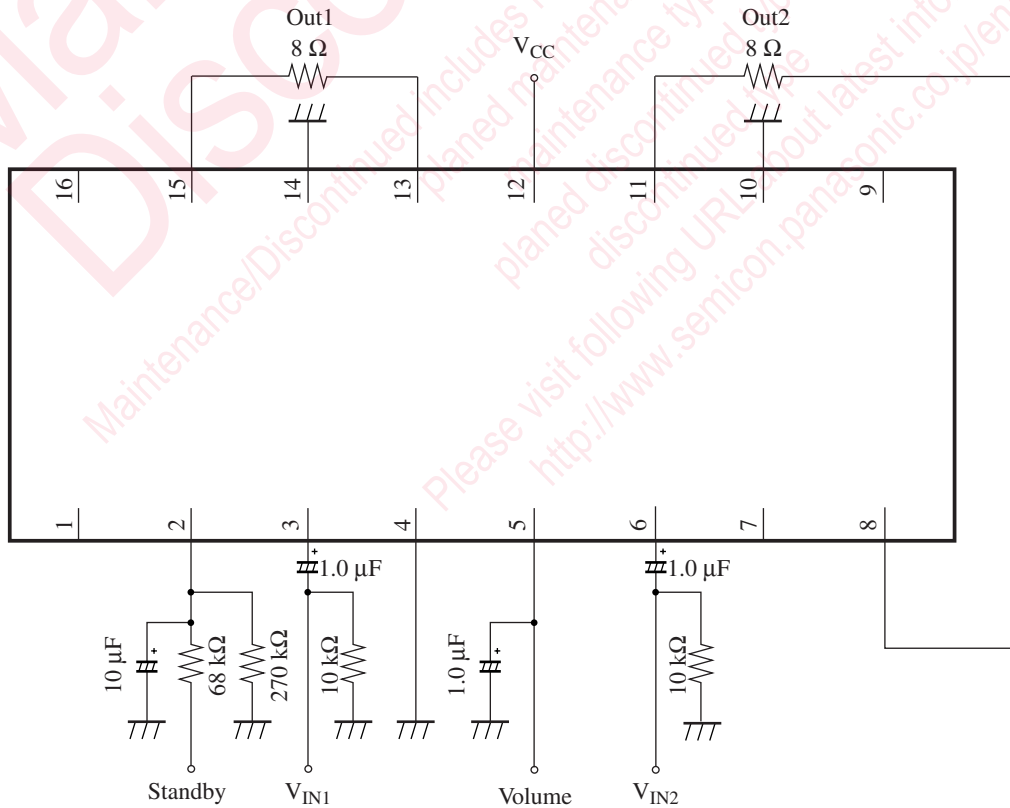

## utions in using the technical information and scribed in this book

s book is to be exported or provided to non-residents, the laws and  
rd to security export control, must be observed.

ly to show the main characteristics and application circuit examples  
l property right or other right owned by our company or any other  
any as to the infringement upon any such right owned by any other  
rmation described in this book.

standard applications or general electronic equipment (such as office  
and household appliances).

ng applications:

biles, traffic control equipment, combustion equipment, life support  
reliability are required, or if the failure or malfunction of the prod-

ck are subject to change without notice for modification and/or im-  
use of the products, therefore, ask for the most up-to-date Product  
atisfy your requirements.

bsolute maximum rating and the guaranteed operating conditions  
(.). Especially, please be careful not to exceed the range of absolute  
er-off and mode-switching. Otherwise, we will not be liable for any

take into the consideration of incidence of break down and failure  
n the systems such as redundant design, arresting the spread of fire  
al injury, fire, social damages, for example, by using the products.

own and characteristics change due to external factors (ESD, EOS,  
mounting or at customer's process. When using products for which  
shelf life and the elapsed time since first opening the packages.

ly or partially, without the prior written permission of Matsushita







## Looking for pricing, stock, or lifecycle information?

Click below to explore more details on WIN SOURCE:

 [View AN7512 on WIN SOURCE](#)

 [Panasonic Information](#)

## Optimize Your Supply Chain with WIN SOURCE Solutions

-  Global Sourcing Solution
-  Obsolete Management
-  Cost Control Management
-  Shortage Management
-  Alternative Solution
-  Excess Inventory Management