



**THE DATASHEET OF
RP12-2415DA**



Features

- 2:1 input voltage range
- 1.6kVDC isolation
- UL certified
- Efficiency up to 88%
- Over current protection
- No minimum load required

Regulated Converter



RP12-A

12 Watt
DIP24/SMD
Single and Dual Output



Description

The RP12-A series DC/DC converters are certified to UL 60950-1 and cUL 60950-1. This makes them ideal for all telecom and industrial applications where approved safety standards are required. The DIP24 package is available in both pinned and SMD case styles and meets military standards for thermal shock and vibration tolerance.

Selection Guide

Part Number	Input Voltage Range [VDC]	Output Voltage [VDC]	Output Current [mA]	Input Current (1) [mA]	Efficiency (1) typ. [%]	Max. Capacitive Load (2) [µF]
RP12-123.3SA (3)	9-18	3.3	3500	1146	84	2000
RP12-1205SA (3)	9-18	5.1	2400	1163	86	2000
RP12-1212SA (3)	9-18	12	1000	1163	86	430
RP12-1215SA (3)	9-18	15	800	1163	86	300
RP12-243.3SA (3)	18-36	3.3	3500	566	85	2000
RP12-2405SA (3)	18-36	5.1	2400	586	87	2000
RP12-2412SA (3)	18-36	12	1000	575	87	430
RP12-2415SA (3)	18-36	15	800	575	87	300
RP12-483.3SA (3)	36-75	3.3	3500	283	85	2000
RP12-4805SA (3)	36-75	5.1	2400	293	87	2000
RP12-4812SA (3)	36-75	12	1000	287	87	430
RP12-4815SA (3)	36-75	15	800	287	87	300
RP12-1205DA (3)	9-18	±5	±1200	1220	82	±1250
RP12-1212DA (3)	9-18	±12	±500	1149	87	±200
RP12-1215DA (3)	9-18	±15	±400	1149	87	±120
RP12-2405DA (3)	18-36	±5	±1200	602	83	±1250
RP12-2412DA (3)	18-36	±12	±500	568	88	±200
RP12-2415DA (3)	18-36	±15	±400	568	88	±120
RP12-4805DA (3)	36-75	±5	±1200	301	83	±1250
RP12-4812DA (3)	36-75	±12	±500	284	88	±200
RP12-4815DA (3)	36-75	±15	±400	284	88	±120

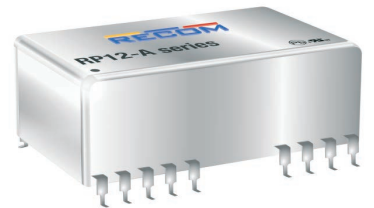

UL60950-1 certified

Notes:

- Note1: Maximum values at nominal input voltage and full load
 Note2: Max. Cap load is tested at minimum Input and constant resistive load

Model Numbering

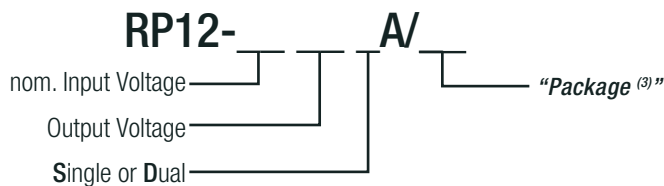

Notes:

- Note3: no suffix for standard package (DIP24)
 add suffix "/SMD" for SMD package

Ordering Examples

- RP12-4805SA/SMD = 48V input, 5V output, single, SMD package
 RP12-1205DA = 12V input, 5V output, dual, DIP24 package

Specifications (measured @ Ta= 25°C, nom. Vin, full load and after warm-up unless otherwise stated)

BASIC CHARACTERISTICS

Parameter	Condition		Min.	Typ.	Max.
Input Filter			Pi-Type		
Input Voltage Range	nom. Vin = 12VDC nom. Vin = 24VDC nom. Vin = 48VDC		9VDC 18VDC 36VDC	12VDC 24VDC 48VDC	18VDC 36VDC 75VDC
Input Surge Voltage	100ms max.	nom. Vin = 12VDC nom. Vin = 24VDC nom. Vin = 48VDC			36VDC 50VDC 100VDC
Under Voltage Lockout (UVLO)	nom. Vin = 12VDC	DC-DC ON DC-DC OFF		8VDC	9VDC
	nom. Vin = 24VDC	DC-DC ON DC-DC OFF		16VDC	18VDC
	nom. Vin = 48VDC	DC-DC ON DC-DC OFF		33VDC	36VDC
Input Reflected Ripple Current ⁽⁴⁾				20mA _{p-p}	
Start-up time	Power up ON/OFF CTRL			450ms 5ms	
Operating Frequency Range			360kHz	400kHz	440kHz
Minimum Load ⁽⁵⁾			10%		
ON/OFF CTRL ⁽⁶⁾	Positive Logic	DC-DC ON DC-DC OFF	Open or 3.0VDC < V _{CTRL} < 12VDC Short or 0VDC < V _{CTRL} < 1.2VDC		
Input Current of CTRL pin	DC-DC ON		-0.5mA		+0.5mA
Standby Current	DC-DC OFF			2.5mA	
Ripple and Noise	20MHz BW, with 1µF MLCC on output			85mV _{p-p}	

Notes:

Note4: Simulated source impedance of 12µH. 12µH inductor in series with +Vin

Note5: The RP12 series requires a minimum of 10% loading on the output to maintain specified regulation

Operation under no-load condition will not damage these devices, however they may not meet all listed specification

Note6: The pin voltage is referenced to -Vin pin

RP12-1205SA

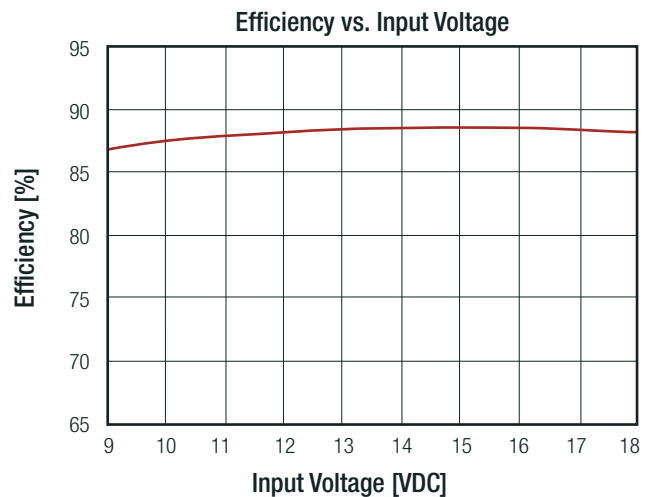
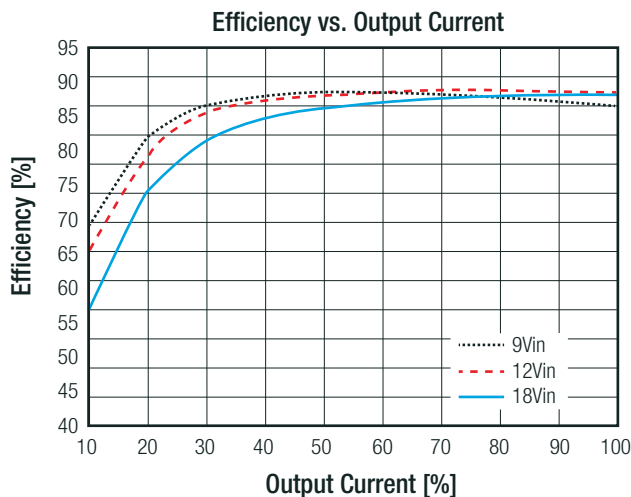

continued on next page

Specifications (measured @ Ta= 25°C, nom. Vin, full load unless otherwise stated)

RP12-2405SA

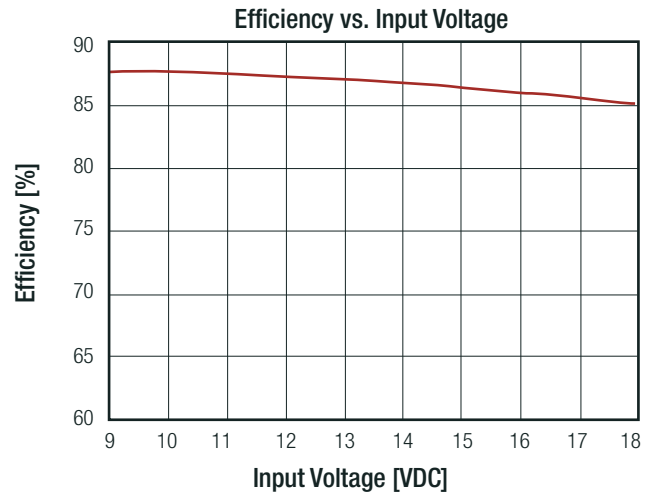
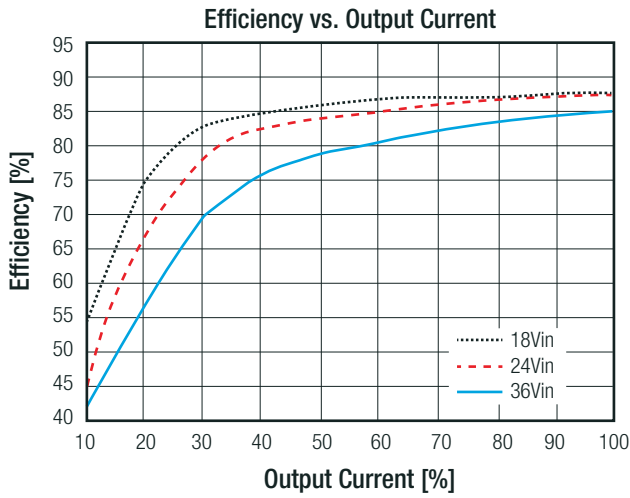

RP12-4805SA

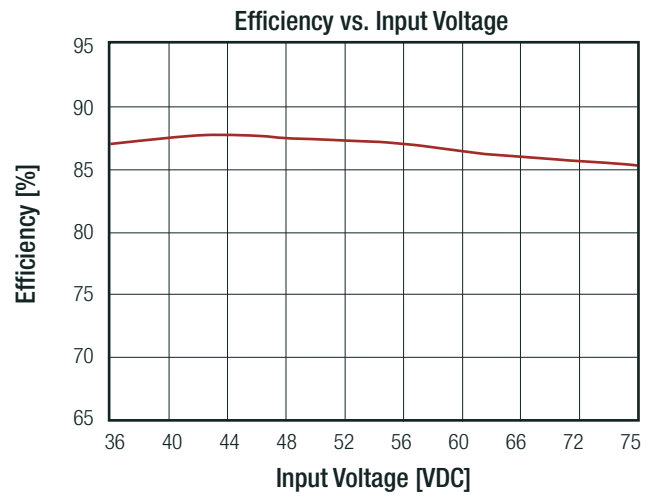
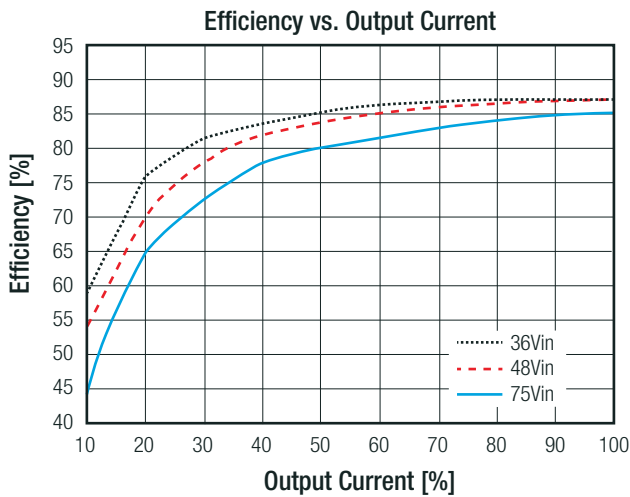

REGULATIONS

Parameter	Condition		Value
Output Accuracy			±1.2%
Line Regulation	low line to high line, full load	Single	±0.2%
		Dual	±0.5%
Load Regulation	Single (0% to 100% load)	DIP24 SMD	±0.5% ±1.0%
	Dual (0% to 100% load)	DIP24, SMD	±1.0%
Cross Regulation	asymmetrical 25%<>100% load		±5.0%
Transient Response Recovery Time	25% load step change		250µs

Specifications (measured @ Ta= 25°C, nom. Vin, full load and after warm-up unless otherwise stated)

PROTECTIONS

Parameter	Condition		Value
Short Circuit Protection (SCP)			continuous, automatic recovery
Over Voltage Protection (OVP)	zener diode clamp	3.3Vout	3.9VDC
		5.1Vout	6.2VDC
		12Vout	15VDC
		15Vout	18VDC
Over Load Protection (OLP)	% of lout rated		150% typ.
Isolation Voltage ⁽⁷⁾	DIP24	I/P to O/P; I/P (O/P) to case	1.6kVDC/1 minute
	SMD	I/P to O/P I/P (O/P) to case	1.6kVDC/1 minute 1.0kVDC/1 minute
Isolation Resistance	Viso= 500VDC		1GΩ min.
Isolation Capacitance			1200pF max.
Notes:			
Note7: For repeat Hi-Pot testing, reduce the time and/or the test voltage			
Note8: This power module is not internally fused. An input line fuse must always be used			

ENVIRONMENTAL

Parameter	Condition		Value
Operating Temperature Range	3.3Vout, ±5Vout	without derating with derating	-40°C to +65°C -40°C to +100°C
	all others	without derating with derating	-40°C to +72°C -40°C to +100°C
Maximum Case Temperature			+100°C
Temperature Coefficient			±0.02%/K max.
Thermal Impedance	@ natural convection 0.1m/s		20K/W typ.
Operating Altitude			4000m
Operating Humidity	non-condensing		5% - 95% RH
Pollution Degree			PD2
Shock			according to MIL-STD-810F
Vibration			according to MIL-STD-810F
MTBF	MIL-HDBK-217F, G.B.		2064 x 10 ³ hours
	BELLCORE TR-NWT-000332 ⁽⁹⁾		2750 x 10 ³ hours

Derating Graph ⁽¹⁰⁾

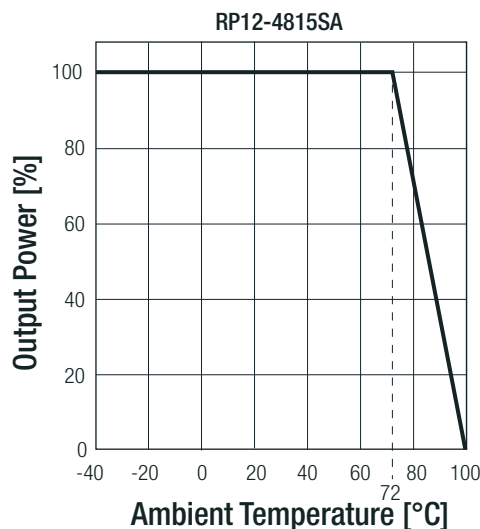

Notes:

Note9: BELLCORE TR-NWT-000332. Case I: 50% Stress, Temperature at 40°C (Ground fixed and controlled environment)

Note10: Derating graphs are valid only for the shown part numbers. If you need detailed derating-information about a part-number not shown here please contact RECOM Techsupport for detailed information

Specifications (measured @ Ta= 25°C, nom. Vin, full load unless otherwise stated)

SAFETY AND CERTIFICATIONS

Certificate Type (Safety)	Condition	Standard
Information Technology Equipment, General Requirements for Safety	E196683	UL60950-1, 2nd Edition, 2014 C22.2 No. 60950-1-07, 2nd Edition, 2014
EAC	AT.AB49.B.09571	TP TC 004/2011
RoHS 2		RoHS-2011/65/EU + AM-2015/863

EMC Compliance

EMC Compliance	Condition	Standard / Criterion
Electromagnetic compatibility of multimedia equipment - Emission requirements	with external filter (see filter suggestion below)	EN55032, Class A and B
ESD Electrostatic discharge immunity test	Air ±8kV and Contact ±6kV	EN61000-4-2, Criteria A
Radiated, radio-frequency, electromagnetic field immunity test	10 V/m	EN61000-4-3, Criteria A
Fast Transient and Burst Immunity ⁽¹⁾	±2kV	EN61000-4-4, Criteria A
Surge Immunity ⁽¹⁾	±1kV	EN61000-4-5, Criteria A
Immunity to conducted disturbances, induced by radio-frequency fields	10 Vr.m.s	EN61000-4-6, Criteria A
Power Magnetic Field Immunity	100A/m continuous; 1000A/m 1s	EN61000-4-8, Criteria A

Notes:

Note11: An external input filter capacitor is required if the module has to meet EN61000-4-4, EN61000-4-5
Recom suggests Nippon chemi-con KY series 220µF/100V

EMC Filtering Suggestions according to EN55032

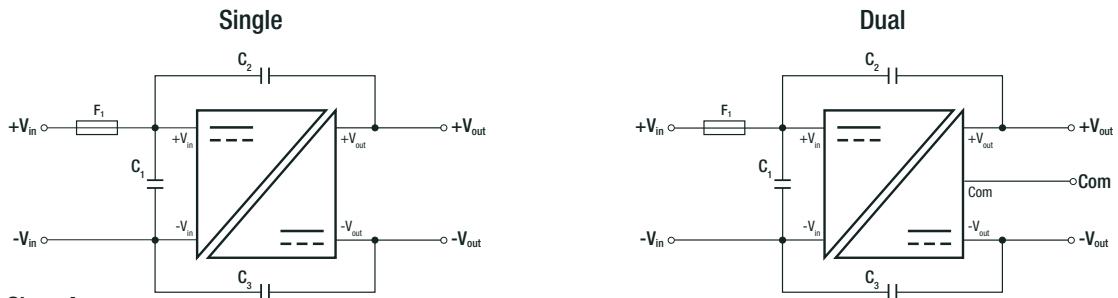

Component List Class A

MODEL	C1	C2/C3
RP12-12xxS_DA, RP12-12xxS_DA/SMD	6.8µF/50V, 1210 MLCC	1000pF/2kV, 1206 MLCC
RP12-24xxS_DA, RP12-24xxS_DA/SMD	4.7µF/50V, 1210 MLCC	1000pF/2kV, 1206 MLCC
RP12-48xxS_DA, RP12-48xxS_DA/SMD	2.2µF/100V, 1812 MLCC	1000pF/2kV, 1206 MLCC

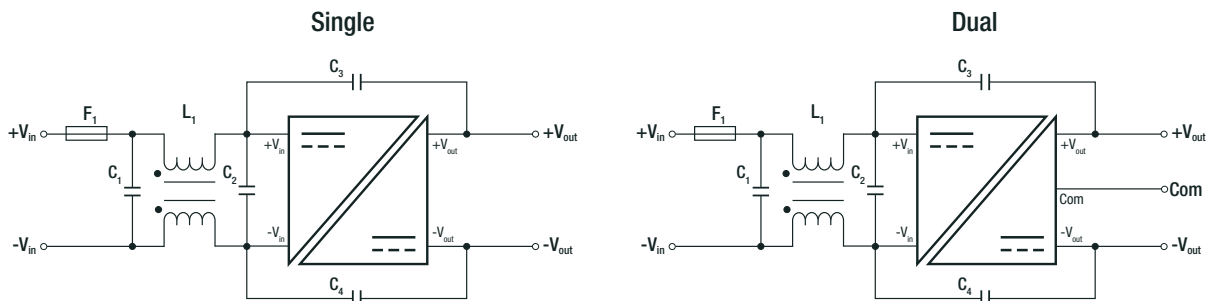

Component List Class B

MODEL	C1	C2	C3/C4	L1
RP12-12xxS_DA RP12-12xxS_DA/SMD	3.3µF/50V, 1812 MLCC	N/A	1000pF/2kV, 1206 MLCC	CMC :325µH ref: WE 744290321 or CMC-06
RP12-24xxS_DA RP12-24xxS_DA/SMD	4.7µF/50V, 1812 MLCC	N/A	1000pF/2kV, 1206 MLCC	CMC: 325µH ref: WE 744290321 or CMC-06
RP12-48xxS_DA RP12-48xxS_DA/SMD	2.2µF/100V, 1812 MLCC	2.2µF/100V, 1812 MLCC	1000pF/2kV, 1206 MLCC	CMC: 325µH ref: WE 744290321 or CMC-06

Specifications (measured @ Ta= 25°C, nom. Vin, full load unless otherwise stated)

DIMENSIONS and PHYSICAL CHARACTERISTICS

Parameter	Type	Value
Material	case	nickel coated copper
	base	non-conductive black plastic
	potting	epoxy (UL94-V0)
Dimensions (LxWxH)	DIP24	31.8 x 20.3 x 10.2mm
	SMD	32.0 x 20.3 x 11.2mm
Weight	DIP24	18g
	SMD	20g

DIP24 Dimension Drawing (mm)

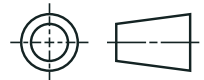
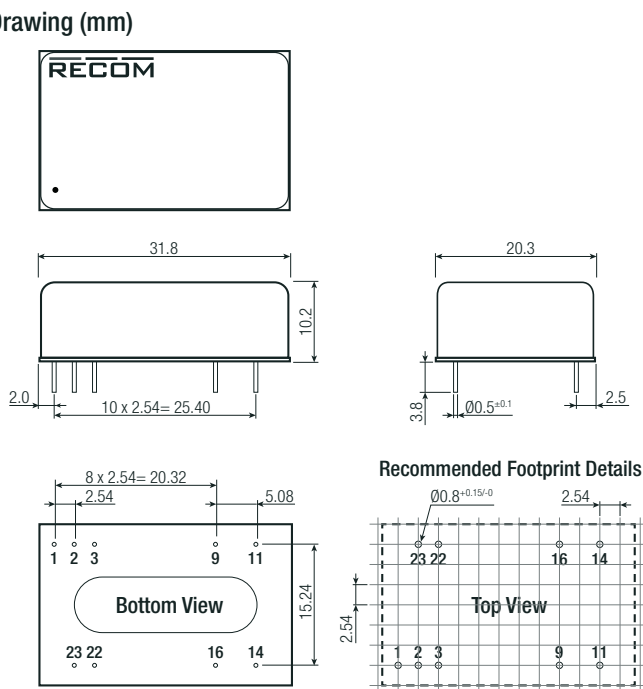

Pin Connections DIP24

Pin #	Single	Dual
1	CTRL	CTRL
2	-Vin	-Vin
3	-Vin	-Vin
9	NC	Com
11	NC	-Vout
14	+Vout	+Vout
16	-Vout	Com
22	+Vin	+Vin
23	+Vin	+Vin

NC = No Connection
Pin Pitch Tolerance ±0.25mm
xx.x = ±0.5mm
xx.xx = ±0.25mm

SMD Dimension Drawing (mm)

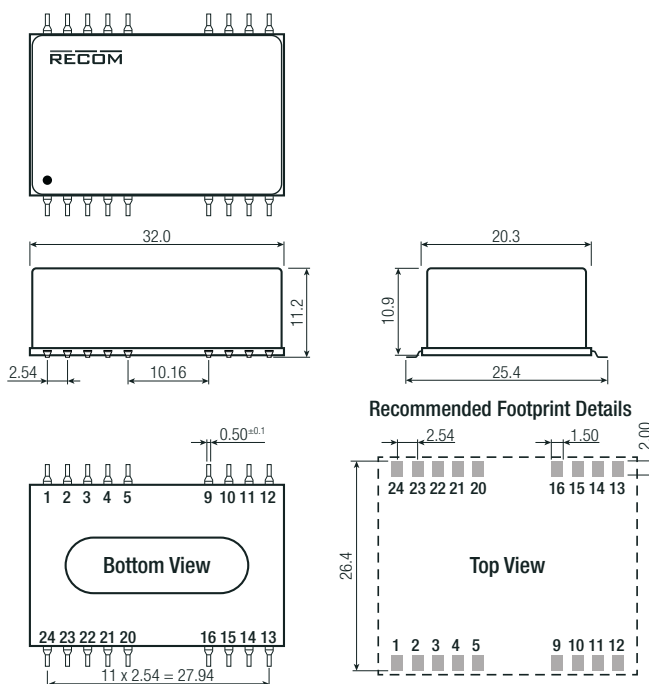

Pin Connections SMD

Pin #	Single	Dual
1	CTRL	CTRL
2	-Vin	-Vin
3	-Vin	-Vin
9	NC	Com
11	NC	-Vout
14	+Vout	+Vout
16	-Vout	Com
22	+Vin	+Vin
23	+Vin	+Vin
Others	NC	NC

NC = No Connection
Pin Pitch Tolerance ±0.25mm
xx.x = ±0.5mm
xx.xx = ±0.25mm



Specifications (measured @ Ta= 25°C, nom. Vin, full load unless otherwise stated)

PACKAGING INFORMATION			
Parameter	Type		Value
Packaging Dimension (LxWxH)	tube	DIP24	255.0 x 23.0 x 19.0mm
		SMD	255.0 x 32.0 x 16.0mm
Packaging Quantity	DIP24, SMD		7pcs
Storage Temperature Range			-55°C to +125°C
Storage Humidity	non-condensing		5% - 95% RH

The product information and specifications may be subject to changes even without prior written notice. The product has been designed for various applications; its suitability lies in the responsibility of each customer. The products are not authorized for use in safety-critical applications without RECOM's explicit written consent. A safety-critical application is an application where a failure may reasonably be expected to endanger or cause loss of life, inflict bodily harm or damage property. The applicant shall indemnify and hold harmless RECOM, its affiliated companies and its representatives against any damage claims in connection with the unauthorized use of RECOM products in such safety-critical applications.

Looking for pricing, stock, or lifecycle information?

Click below to explore more details on WIN SOURCE:

-  [View RP12-2415DA on WIN SOURCE](#)
-  [Recom Power Information](#)

Optimize Your Supply Chain with WIN SOURCE Solutions

-  Global Sourcing Solution
-  Obsolete Management
-  Cost Control Management
-  Shortage Management
-  Alternative Solution
-  Excess Inventory Management