



THE DATASHEET OF CD4097BE



CD4067B, CD4097B Types

CMOS Analog Multiplexers/Demultiplexers

High-Voltage Types (20-Volt Rating)

CD4067B – Single 16-Channel Multiplexer/Demultiplexer

CD4097B – Differential 8-Channel Multiplexer/Demultiplexer

CD4067B and CD4097B CMOS

analog multiplexers/demultiplexers* are digitally controlled analog switches having low ON impedance, low OFF leakage current, and internal address decoding. In addition, the ON resistance is relatively constant over the full input-signal range.

The CD4067B is a 16-channel multiplexer with four binary control inputs, A,B,C,D, and an inhibit input, arranged so that any combination of the inputs selects one switch.

The CD4097B is a differential 8-channel multiplexer having three binary control inputs A, B, C, and an inhibit input. The inputs permit selection of one of eight pairs of switches.

A logic "1" present at the inhibit input turns all channels off.

The CD4067B and CD4097B types are supplied in 24-lead hermetic dual-in-line ceramic packages (F3A suffix), 24-lead dual-in-line plastic packages (E suffix), 24-lead small-outline packages (M, M96, and NSR suffixes), and 24-lead thin shrink small-outline packages (P and PWR suffixes).

*When these devices are used as demultiplexers, the channel in/out terminals are the outputs and the common out/in terminals are the inputs.

Recommended Operating Conditions at $T_A = 25^\circ\text{C}$ (Unless Otherwise Specified)

For maximum reliability, nominal operating conditions should be selected so that operation is always within the following ranges. Values shown apply to all types except as noted.

Characteristic	Min.	Max.	Units
Supply-Voltage Range (T_A =Full Package-Temp. Range)	3	18	V
Multiplexer Switch Input Current Capability	–	25	mA
Output Load Resistance	100	–	Ω

NOTE:

In certain applications, the external load-resistor current may include both V_{DD} and signal-line components. To avoid drawing V_{DD} current when switch current flows into the transmission gate inputs, the voltage drop across the bidirectional switch must not exceed 0.8 volt (calculated from R_{ON} values shown in ELECTRICAL CHARACTERISTICS CHART). No V_{DD} current will flow through R_L if the switch current flows into terminal 1 on the CD4067; terminals 1 and 17 on the CD4097.

Features:

- Low ON resistance: 125Ω (typ.) over 15 V_{pp} signal-input range for $V_{DD}-V_{SS}=15 \text{ V}$
- High OFF resistance: channel leakage of $\pm 10 \text{ pA}$ (typ.) @ $V_{DD}-V_{SS}=10 \text{ V}$
- Matched switch characteristics: $R_{ON}=5 \Omega$ (typ.) for $V_{DD}-V_{SS}=15 \text{ V}$
- Very low quiescent power dissipation under all digital-control input and supply conditions: $0.2 \mu\text{W}$ (typ.) @ $V_{DD}-V_{SS}=10 \text{ V}$
- Binary address decoding on chip
- 5-V, 10-V, and 15-V parametric ratings
- 100% tested for quiescent current at 20 V
- Standardized symmetrical output characteristics
- Maximum input current of $1 \mu\text{A}$ at 18 V over full package temperature range; 100 nA at 18 V and 25°C
- Meets all requirements of JEDEC Tentative Standard No. 13B, "Standard Specifications for Description of 'B' Series CMOS Devices"

Applications:

- Analog and digital multiplexing and demultiplexing
- A/D and D/A conversion
- Signal gating

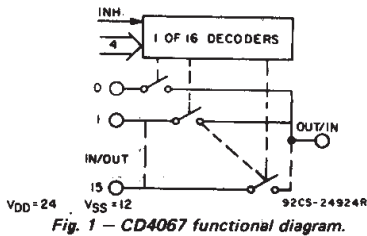
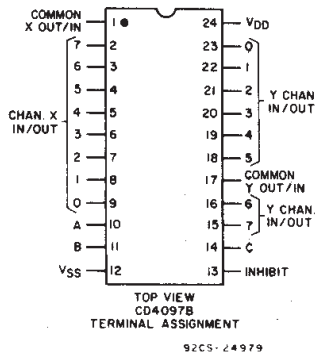
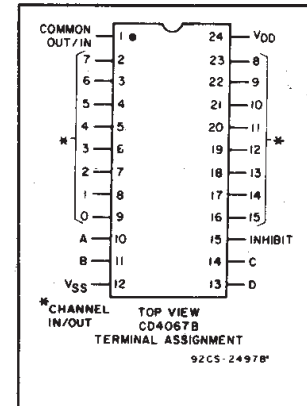

Fig. 1 – CD4067 functional diagram.

CD4067 TRUTH TABLE

A	B	C	D	Inh	Selected Channel
X	X	X	X	1	None
0	0	0	0	0	0
1	0	0	0	0	1
0	1	0	0	0	2
1	1	0	0	0	3
0	0	1	0	0	4
1	0	1	0	0	5
0	1	1	0	0	6
1	1	1	0	0	7
0	0	0	1	0	8
1	0	0	1	0	9
0	1	0	1	0	10
1	1	0	1	0	11
0	0	1	1	0	12
1	0	1	1	0	13
0	1	1	1	0	14
1	1	1	1	0	15

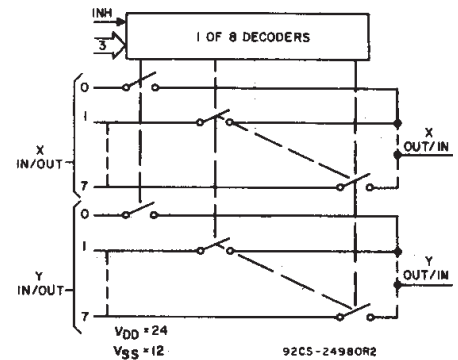

Fig. 2 – CD4097 functional diagram.

CD4097 TRUTH TABLE

A	B	C	Inh	Selected Channel
X	X	X	1	None
0	0	0	0	0X, 0Y
1	0	0	0	1X, 1Y
0	1	0	0	2X, 2Y
1	1	0	0	3X, 3Y
0	0	1	0	4X, 4Y
1	0	1	0	5X, 5Y
0	1	1	0	6X, 6Y
1	1	1	0	7X, 7Y

3
COMMERCIAL CMOS
HIGH VOLTAGE ICs

CD4067B, CD4097B Types

ELECTRICAL CHARACTERISTICS

CHARACTERISTIC	CONDITIONS			LIMITS AT INDICATED TEMPERATURES (°C)						Units	
	V_{is} (V)	V_{SS} (V)	V_{DD} (V)	-55	-40	+85	+125	+25			
								Min.	Typ.		Max.
SIGNAL INPUTS (V_{is}) AND OUTPUTS (V_{OS})											
Quiescent Device Current, I_{DD} Max.			5	5	5	150	150	—	0.04	5	μ A
			10	10	10	300	300	—	0.04	10	
			15	20	20	600	600	—	0.04	20	
			20	100	100	3000	3000	—	0.08	100	
ON-state Resistance $V_{SS} \leq V_{is} \leq V_{DD}$ r_{on} Max.		0	5	800	850	1200	1300	—	470	1050	Ω
		0	10	310	330	520	550	—	180	400	
		0	15	200	210	300	320	—	125	240	
Change in on-state Resistance (Between Any Two Channels) Δr_{on}		0	5	—	—	—	—	—	15	—	Ω
		0	10	—	—	—	—	—	10	—	
		0	15	—	—	—	—	—	5	—	
OFF Channel Leakage Current: Any Channel OFF (Common OUT/IN) Max. or All Channels OFF		0	18	$\pm 100^*$		$\pm 1000^*$			± 0.1	$\pm 100^*$	nA
Capacitance: Input, C_{is} Output, C_{os} CD4067 CD4097 Feed-through, C_{ios}				—	—	—	—	—	5	—	pF
		-5	5	—	—	—	—	—	55	—	
				—	—	—	—	—	35	—	
Propagation Delay Time (Signal Input to Output)	V_{DD} 	$R_L = 200 \text{ K}\Omega$ $C_L = 50 \text{ pF}$ $t_r, t_f = 20 \text{ ns}$	5	—	—	—	—	—	30	60	ns
			10	—	—	—	—	—	15	30	
			15	—	—	—	—	—	10	20	
CONTROL (ADDRESS or INHIBIT) V_C											
Input Low Voltage, V_{IL} Max.	$=V_{DD}$ thru $1 \text{ K}\Omega$	$R_L = 1 \text{ K}\Omega$ to V_{SS} $I_{IS} < 2 \mu\text{A}$ on all OFF Channels	5	1.5						1.5	V
			10	3						3	
			15	4						4	
Input High Voltage, V_{IH} Min.	$=V_{DD}$ thru $1 \text{ K}\Omega$	$R_L = 1 \text{ K}\Omega$ to V_{SS} $I_{IS} < 2 \mu\text{A}$ on all OFF Channels	5	3.5				3.5			
			10	7			7				
			15	11			11				

* Determined by minimum feasible leakage measurement for automatic testing.

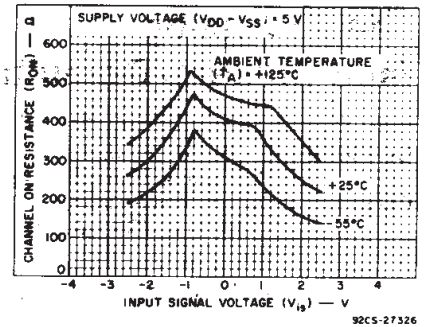

Fig. 3—Typical ON resistance vs. input signal voltage (all types).

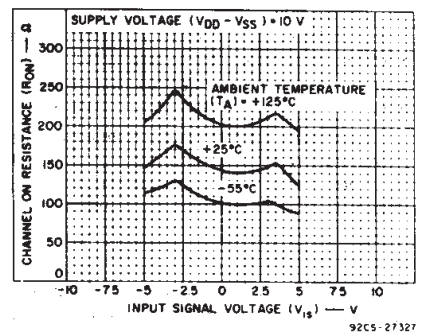

Fig. 4—Typical ON resistance vs. input signal voltage (all types).

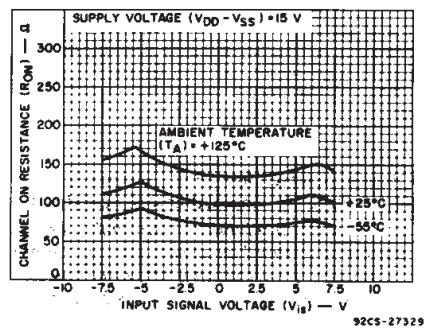

Fig. 5—Typical ON resistance vs. input signal voltage (all types).

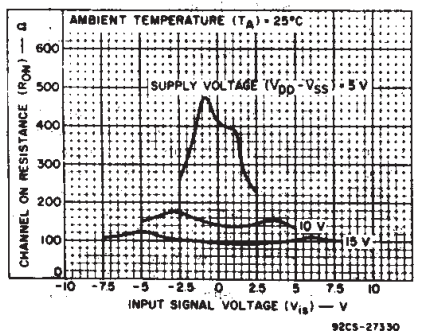

Fig. 6—Typical ON resistance vs. input signal voltage (all types).

CD4067B, CD4097B Types

ELECTRICAL CHARACTERISTICS (Cont'd)

CHARACTERISTIC	CONDITIONS			LIMITS AT INDICATED TEMPERATURES (°C)							Units
	V _{is} (V)	V _{SS} (V)	V _{DD} (V)	-55	-40	+85	+125	+25			
								Min.	Typ.	Max.	
Input Current, I _{IN} Max.	V _{IN} = 0, 18 V			±0.1	±0.1	±1	±1	—	±10 ⁻⁵	±0.1	μA
Propagation Delay Time: Address or Inhibit-to-Signal OUT (Channel turning ON)	R _L = 10 KΩ, C _L = 50 pF, t _r , t _f = 20 ns			—	—	—	—	—	325	650	ns
	0	5	—	—	—	—	—	—	135	270	
	0	10	—	—	—	—	—	—	95	190	
Address or Inhibit-to-Signal OUT (Channel turning OFF)	R _L = 300 Ω, C _L = 50 pF, t _r , t _f = 20 ns			—	—	—	—	—	220	440	ns
	0	5	—	—	—	—	—	—	90	180	
	0	15	—	—	—	—	—	—	65	130	
Input Capacitance, C _{IN}	Any Address or Inhibit Input			—	—	—	—	—	5	7.5	pF

TEST CIRCUITS

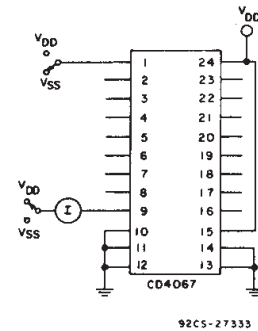

92CS-27333

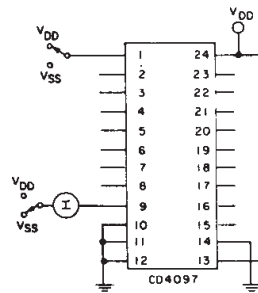

92CS-27332

Fig. 7—OFF channel leakage current—any channel OFF.

MAXIMUM RATINGS, Absolute-Maximum Values:

- DC SUPPLY-VOLTAGE RANGE, (V_{DD})
Voltages referenced to V_{SS} Terminal) -0.5V to +20V
- INPUT VOLTAGE RANGE, ALL INPUTS -0.5V to V_{DD} +0.5V
- DC INPUT CURRENT, ANY ONE INPUT ±10mA
- POWER DISSIPATION PER PACKAGE (P_D):
For T_A = -55°C to +100°C 500mW
For T_A = +100°C to +125°C Derate Linearly at 12mW/°C to 200mW
- DEVICE DISSIPATION PER OUTPUT TRANSISTOR
FOR T_A = FULL PACKAGE-TEMPERATURE RANGE (All Package Types) 100mW
- OPERATING-TEMPERATURE RANGE (T_A) -55°C to +125°C
- STORAGE TEMPERATURE RANGE (T_{stg}) -65°C to +150°C
- LEAD TEMPERATURE (DURING SOLDERING):
At distance 1/16 ± 1/32 inch (1.59 ± 0.79mm) from case for 10s max +265°C

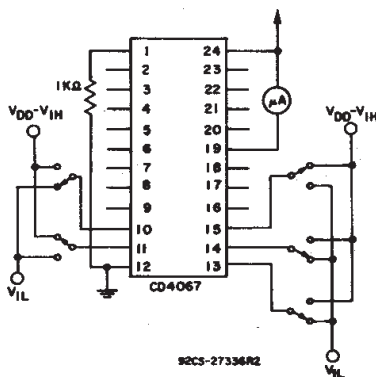

92CS-27336R2

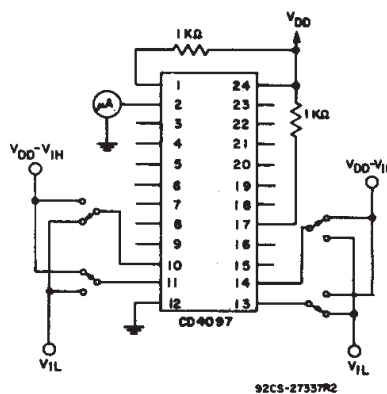

92CS-27337R2

Fig. 8—Input voltage—measure < 2 μA on all OFF channels (e.g., channel 12).

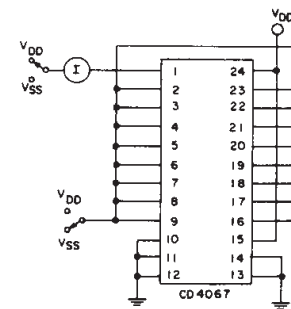

92CS-27334

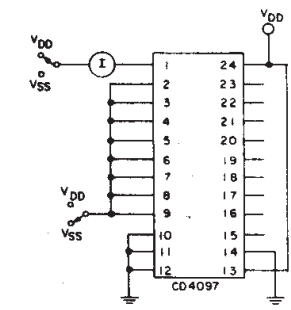

92CS-27335

Fig. 9—OFF channel leakage current—all channels OFF.

3
COMMERCIAL CMOS
HIGH VOLTAGE ICs

CD4067B, CD4097B Types

ELECTRICAL CHARACTERISTICS (Cont'd)

CHARACTERISTIC	TEST CONDITIONS			TYPICAL VALUES	UNITS		
	V _{is} (V)	V _{DD} (V)	R _L (KΩ)				
Cutoff (-3 dB) Frequency Channel ON (Sine Wave Input)	5 [●]	10	1	CD4067	14	MHz	
	20 log $\frac{V_{os}}{V_{is}} = -3$ dB			CD4097	20		
V _{os} at Common OUT/IN							
V _{os} at Any Channel				60			
Total Harmonic Distortion, THD	2 [●]	5	10	0.3		%	
	3 [●]	10		0.2			
	5 [●]	15		0.12			
	f _{is} = 1 kHz sine wave						
-40 dB Feedthrough Frequency (All Channels OFF)	5 [●]	10	1	CD4067	20	MHz	
	20 log $\frac{V_{os}}{V_{is}} = -40$ dB			CD4097	12		
V _{os} at Any Channel				8			
Signal Crosstalk (Frequency at -40 dB)	5 [●]	10	1	Between Any 2 Channels [▲]		1	MHz
	20 log $\frac{V_{os}}{V_{is}} = -40$ dB			Between Sections CD4097 Only	Measured on Common	10	
					Measured on Any Channel	18	
Address-or-Inhibit-to-Signal Crosstalk	V _{SS} =0, t _r , t _f =20 ns, V _C =V _{DD} -V _{SS} (Square Wave)					75	mV (Peak)

● Peak-to-peak voltage symmetrical about $\frac{V_{DD}-V_{SS}}{2}$.

▲ Worst case.

* Both ends of channel.

TEST CIRCUITS (Cont'd)

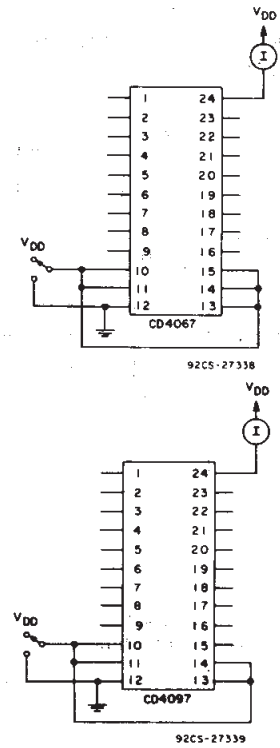

Fig. 10—Quiescent device current.

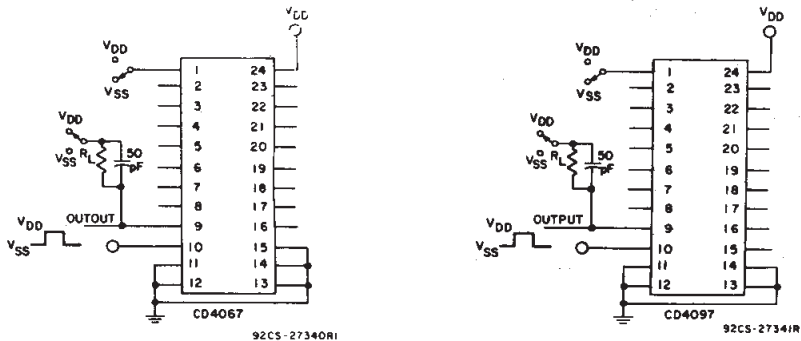

Fig. 11—Turn-on and turn-off propagation delay—address select input to signal output (e.g. measured on channel 0).

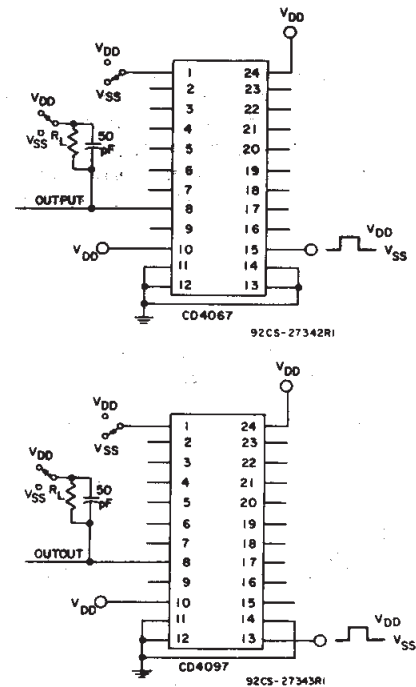

Fig. 12—Turn-on and turn-off propagation delay—
inhibit input to signal output (e.g. measured on channel 1).

CD4067B, CD4097B Types

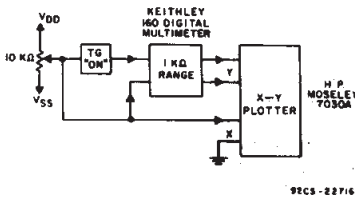

Fig. 13- Channel ON resistance measurement circuit.

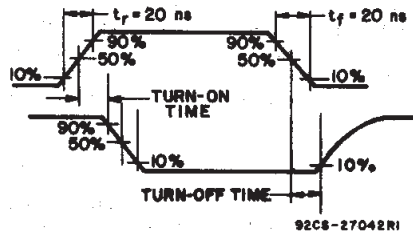

Fig. 14- Propagation delay waveform channel being turned ON ($R_L = 10\text{ K}\Omega$, $C_L = 50\text{ pF}$).

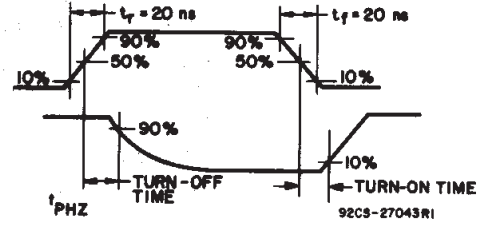

Fig. 15- Propagation delay waveform, channel being turned OFF ($R_L = 300\ \Omega$, $C_L = 50\text{ pF}$).

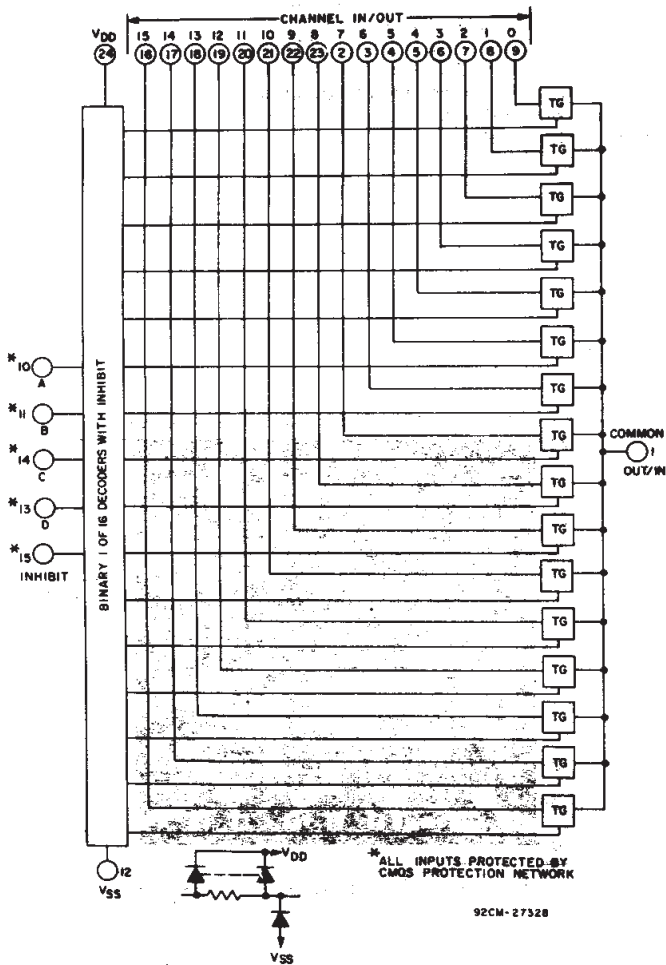

Fig. 16- CD4067 logic diagram.

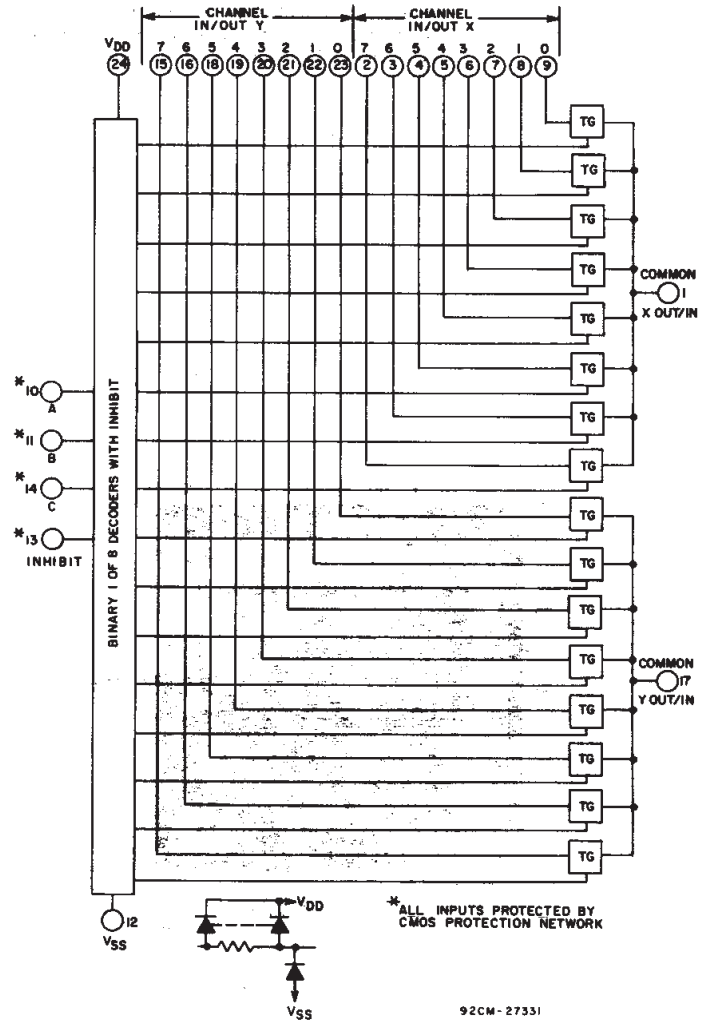

Fig. 17- CD4097 logic diagram.

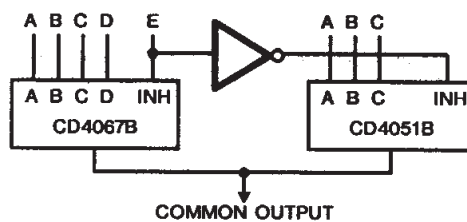

Fig. 18-24-to-1 MUX Addressing

3
COMMERCIAL CMOS
HIGH VOLTAGE ICs

CD4067B, CD4097B Types

SPECIAL CONSIDERATIONS

In applications where separate power sources are used to drive V_{DD} and the signal inputs, the V_{DD} current capability should exceed V_{DD}/R_L (R_L =effective external load). This provision avoids permanent current flow or clamp action on the V_{DD} supply when power is applied or removed from the CD4067B or CD4097B.

When switching from one address to another, some of the ON periods of the channels of the multiplexers will overlap momentarily, which may be objectionable in certain applications. Also when a channel is turned on or off by an address input, there is a momentary conductive path from the channel to V_{SS} , which will dump some charge from any capacitor connected to the input or output of the channel. The inhibit input turning on a channel will similarly dump some charge to V_{SS} .

The amount of charge dumped is mostly a function of the signal level above V_{SS} . Typically, at $V_{DD}-V_{SS}=10$ V, a 100-pF

capacitor connected to the input or output of the channel will lose 3-4% of its voltage at the moment the channel turns on or off. This loss of voltage is essentially independent of the address or inhibit signal transition time, if the transition time is less than 1-2 μ s. When the inhibit signal turns a channel off, there is no charge dumping to V_{SS} . Rather, there is a slight rise in the channel voltage level (65 mV typ.) due to capacitive coupling from inhibit input to channel input or output. Address inputs also couple some voltage steps onto the channel signal levels.

In certain applications, the external load-resistor current may include both V_{DD} and signal-line components. To avoid drawing V_{DD} current when switch current flows into the transmission gate inputs, the voltage drop across the bidirectional switch must not exceed 0.8 volt (calculated from R_{ON} values shown in ELECTRICAL CHARACTERISTICS CHART). No V_{DD} current will flow through R_L if the switch current flows into terminal 1 on the CD4067B, terminals 1 and 17 on the CD4097B.

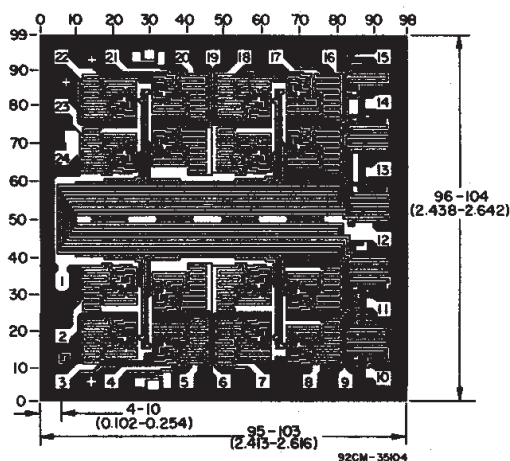

Dimensions and pad layout for CD4067BH.

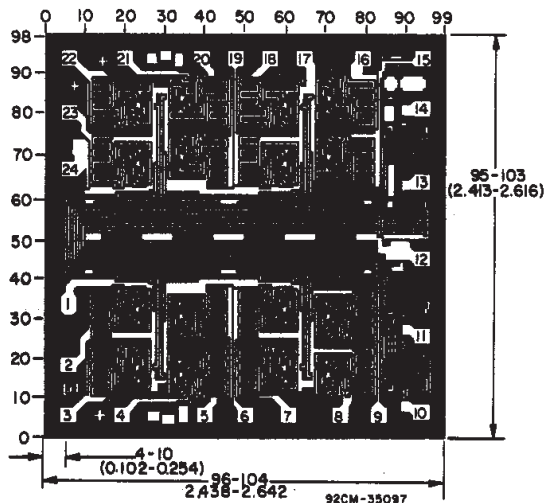

Dimensions and pad layout for CD4097BH.

Dimensions in parentheses are in millimeters and are derived from the basic inch dimensions as indicated. Grid graduations are in mils (10^{-3} inch).

PACKAGING INFORMATION

Orderable Device	Status (1)	Package Type	Package Drawing	Pins	Package Qty	Eco Plan (2)	Lead/Ball Finish (6)	MSL Peak Temp (3)	Op Temp (°C)	Device Marking (4/5)	Samples
CD4067BF	ACTIVE	CDIP	J	24	1	TBD	Call TI	N / A for Pkg Type	-55 to 125	CD4067BF	Samples
CD4067BF3A	ACTIVE	CDIP	J	24	1	TBD	Call TI	N / A for Pkg Type	-55 to 125	CD4067BF3A	Samples
CD4067BM	ACTIVE	SOIC	DW	24	25	Green (RoHS & no Sb/Br)	CU NIPDAU	Level-1-260C-UNLIM	-55 to 125	CD4067BM	Samples
CD4067BM96	ACTIVE	SOIC	DW	24	2000	Green (RoHS & no Sb/Br)	CU NIPDAU CU SN	Level-1-260C-UNLIM	-55 to 125	CD4067BM	Samples
CD4067BM96E4	ACTIVE	SOIC	DW	24	2000	Green (RoHS & no Sb/Br)	CU NIPDAU	Level-1-260C-UNLIM	-55 to 125	CD4067BM	Samples
CD4067BM96G4	ACTIVE	SOIC	DW	24	2000	Green (RoHS & no Sb/Br)	CU NIPDAU	Level-1-260C-UNLIM	-55 to 125	CD4067BM	Samples
CD4067BPW	ACTIVE	TSSOP	PW	24	60	Green (RoHS & no Sb/Br)	CU NIPDAU	Level-1-260C-UNLIM	-55 to 125	CM067B	Samples
CD4067BPWG4	ACTIVE	TSSOP	PW	24	60	Green (RoHS & no Sb/Br)	CU NIPDAU	Level-1-260C-UNLIM	-55 to 125	CM067B	Samples
CD4067BPWR	ACTIVE	TSSOP	PW	24	2000	Green (RoHS & no Sb/Br)	CU NIPDAU	Level-1-260C-UNLIM	-55 to 125	CM067B	Samples
CD4097BF	ACTIVE	CDIP	J	24	1	TBD	Call TI	N / A for Pkg Type	-55 to 125	CD4097BF	Samples
CD4097BM	ACTIVE	SOIC	DW	24	25	Green (RoHS & no Sb/Br)	CU NIPDAU	Level-1-260C-UNLIM	-55 to 125	CD4097BM	Samples
CD4097BME4	ACTIVE	SOIC	DW	24	25	Green (RoHS & no Sb/Br)	CU NIPDAU	Level-1-260C-UNLIM	-55 to 125	CD4097BM	Samples
CD4097BMG4	ACTIVE	SOIC	DW	24	25	Green (RoHS & no Sb/Br)	CU NIPDAU	Level-1-260C-UNLIM	-55 to 125	CD4097BM	Samples
CD4097BPW	ACTIVE	TSSOP	PW	24	60	Green (RoHS & no Sb/Br)	CU NIPDAU	Level-1-260C-UNLIM	-55 to 125	CM097B	Samples
CD4097BPWR	ACTIVE	TSSOP	PW	24	2000	Green (RoHS & no Sb/Br)	CU NIPDAU	Level-1-260C-UNLIM	-55 to 125	CM097B	Samples
CD4097BPWRE4	ACTIVE	TSSOP	PW	24	2000	Green (RoHS & no Sb/Br)	CU NIPDAU	Level-1-260C-UNLIM	-55 to 125	CM097B	Samples

(1) The marketing status values are defined as follows:

ACTIVE: Product device recommended for new designs.

LIFEBUY: TI has announced that the device will be discontinued, and a lifetime-buy period is in effect.

NRND: Not recommended for new designs. Device is in production to support existing customers, but TI does not recommend using this part in a new design.

PREVIEW: Device has been announced but is not in production. Samples may or may not be available.

OBSOLETE: TI has discontinued the production of the device.

⁽²⁾ **RoHS:** TI defines "RoHS" to mean semiconductor products that are compliant with the current EU RoHS requirements for all 10 RoHS substances, including the requirement that RoHS substance do not exceed 0.1% by weight in homogeneous materials. Where designed to be soldered at high temperatures, "RoHS" products are suitable for use in specified lead-free processes. TI may reference these types of products as "Pb-Free".

RoHS Exempt: TI defines "RoHS Exempt" to mean products that contain lead but are compliant with EU RoHS pursuant to a specific EU RoHS exemption.

Green: TI defines "Green" to mean the content of Chlorine (Cl) and Bromine (Br) based flame retardants meet JS709B low halogen requirements of ≤ 1000 ppm threshold. Antimony trioxide based flame retardants must also meet the ≤ 1000 ppm threshold requirement.

⁽³⁾ MSL, Peak Temp. - The Moisture Sensitivity Level rating according to the JEDEC industry standard classifications, and peak solder temperature.

⁽⁴⁾ There may be additional marking, which relates to the logo, the lot trace code information, or the environmental category on the device.

⁽⁵⁾ Multiple Device Markings will be inside parentheses. Only one Device Marking contained in parentheses and separated by a "~" will appear on a device. If a line is indented then it is a continuation of the previous line and the two combined represent the entire Device Marking for that device.

⁽⁶⁾ Lead/Ball Finish - Orderable Devices may have multiple material finish options. Finish options are separated by a vertical ruled line. Lead/Ball Finish values may wrap to two lines if the finish value exceeds the maximum column width.

Important Information and Disclaimer: The information provided on this page represents TI's knowledge and belief as of the date that it is provided. TI bases its knowledge and belief on information provided by third parties, and makes no representation or warranty as to the accuracy of such information. Efforts are underway to better integrate information from third parties. TI has taken and continues to take reasonable steps to provide representative and accurate information but may not have conducted destructive testing or chemical analysis on incoming materials and chemicals. TI and TI suppliers consider certain information to be proprietary, and thus CAS numbers and other limited information may not be available for release.

In no event shall TI's liability arising out of such information exceed the total purchase price of the TI part(s) at issue in this document sold by TI to Customer on an annual basis.

OTHER QUALIFIED VERSIONS OF CD4067B, CD4067B-MIL, CD4097B, CD4097B-MIL :

● Catalog: [CD4067B](#), [CD4097B](#)

● Military: [CD4067B-MIL](#), [CD4097B-MIL](#)

NOTE: Qualified Version Definitions:

● Catalog - TI's standard catalog product

- Military - QML certified for Military and Defense Applications

TAPE AND REEL INFORMATION

QUADRANT ASSIGNMENTS FOR PIN 1 ORIENTATION IN TAPE

*All dimensions are nominal

Device	Package Type	Package Drawing	Pins	SPQ	Reel Diameter (mm)	Reel Width W1 (mm)	A0 (mm)	B0 (mm)	K0 (mm)	P1 (mm)	W (mm)	Pin1 Quadrant
CD4067BM96	SOIC	DW	24	2000	330.0	24.4	10.75	15.7	2.7	12.0	24.0	Q1
CD4067BM96G4	SOIC	DW	24	2000	330.0	24.4	10.75	15.7	2.7	12.0	24.0	Q1
CD4067BPWR	TSSOP	PW	24	2000	330.0	16.4	6.95	8.3	1.6	8.0	16.0	Q1
CD4097BPWR	TSSOP	PW	24	2000	330.0	16.4	6.95	8.3	1.6	8.0	16.0	Q1

TAPE AND REEL BOX DIMENSIONS



*All dimensions are nominal

Device	Package Type	Package Drawing	Pins	SPQ	Length (mm)	Width (mm)	Height (mm)
CD4067BM96	SOIC	DW	24	2000	350.0	350.0	43.0
CD4067BM96G4	SOIC	DW	24	2000	350.0	350.0	43.0
CD4067BPWR	TSSOP	PW	24	2000	367.0	367.0	38.0
CD4097BPWR	TSSOP	PW	24	2000	367.0	367.0	38.0

J (R-GDIP-T**)

CERAMIC DUAL-IN-LINE PACKAGE

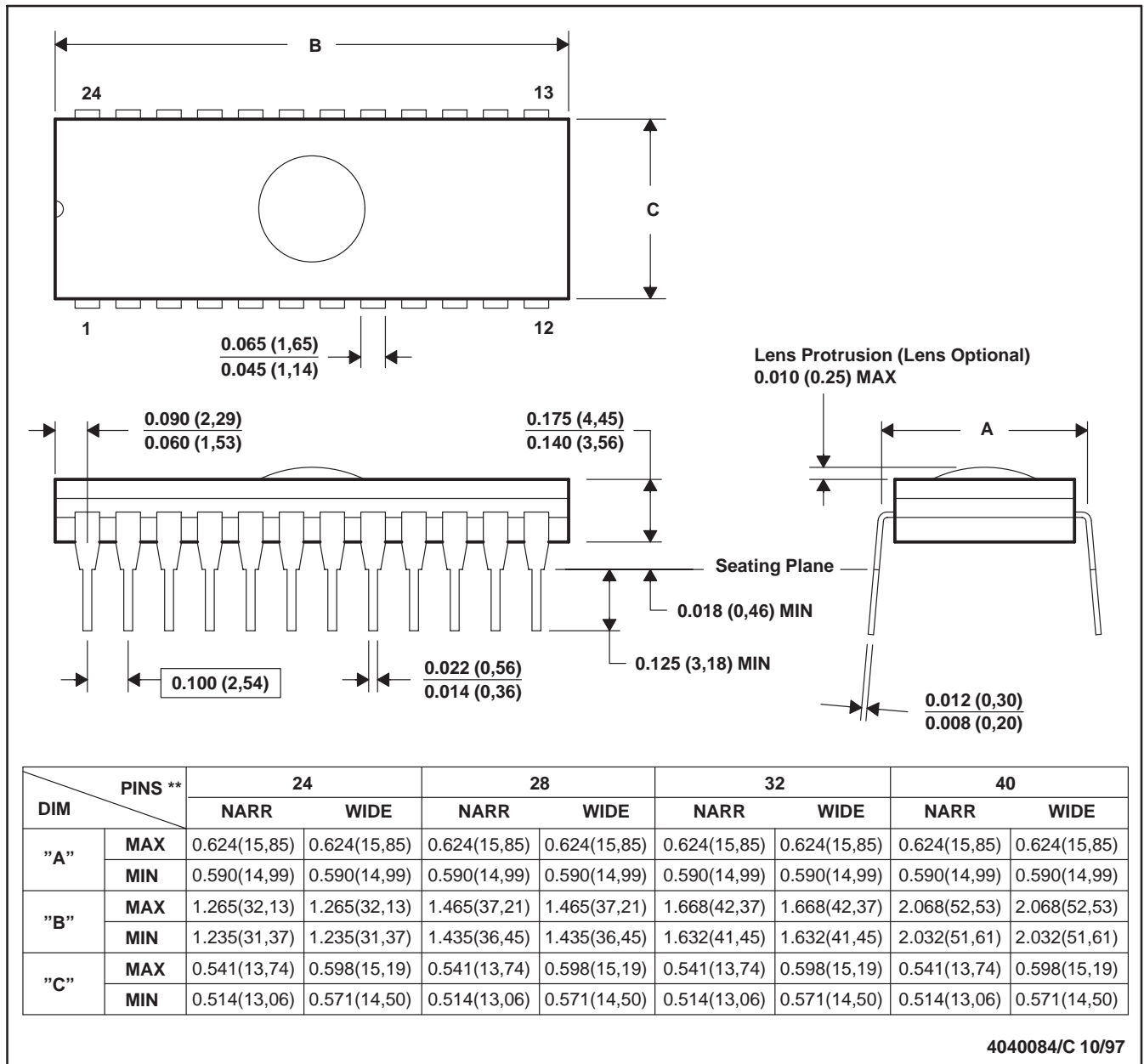
24 PINS SHOWN



- NOTES: A. All linear dimensions are in inches (millimeters).
 B. This drawing is subject to change without notice.
 C. Window (lens) added to this group of packages (24-, 28-, 32-, 40-pin).
 D. This package can be hermetically sealed with a ceramic lid using glass frit.
 E. Index point is provided on cap for terminal identification.

EXAMPLE BOARD LAYOUT

PW0024A

TSSOP - 1.2 mm max height

SMALL OUTLINE PACKAGE



LAND PATTERN EXAMPLE
EXPOSED METAL SHOWN
SCALE: 10X

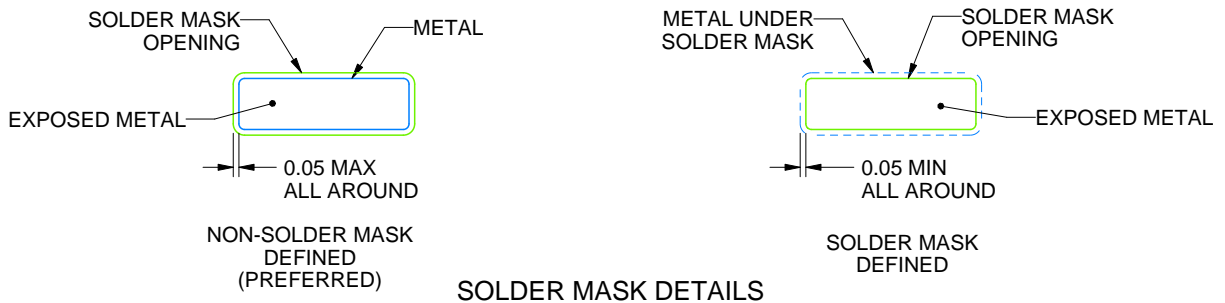

SOLDER MASK DETAILS

4220208/A 02/2017

NOTES: (continued)

- 6. Publication IPC-7351 may have alternate designs.
- 7. Solder mask tolerances between and around signal pads can vary based on board fabrication site.

EXAMPLE STENCIL DESIGN

PW0024A

TSSOP - 1.2 mm max height

SMALL OUTLINE PACKAGE



NOTES: (continued)

8. Laser cutting apertures with trapezoidal walls and rounded corners may offer better paste release. IPC-7525 may have alternate design recommendations.
9. Board assembly site may have different recommendations for stencil design.

DW (R-PDSO-G24)

PLASTIC SMALL OUTLINE



- NOTES:
- A. All linear dimensions are in inches (millimeters). Dimensioning and tolerancing per ASME Y14.5M-1994.
 - B. This drawing is subject to change without notice.
 - C. Body dimensions do not include mold flash or protrusion not to exceed 0.006 (0,15).
 - D. Falls within JEDEC MS-013 variation AD.

DW (R-PDSO-G24)

PLASTIC SMALL OUTLINE

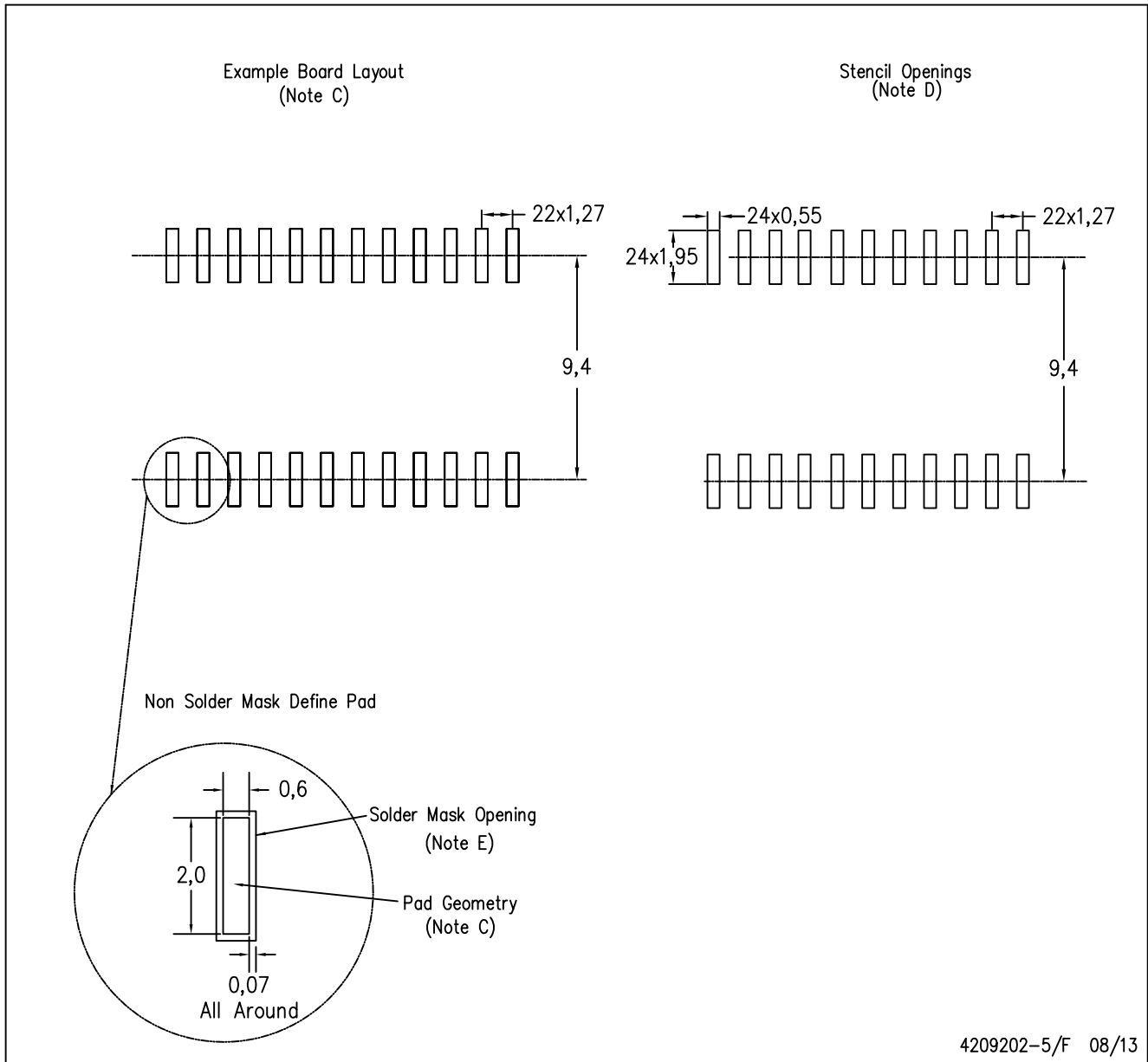

- NOTES:
- A. All linear dimensions are in millimeters.
 - B. This drawing is subject to change without notice.
 - C. Refer to IPC7351 for alternate board design.
 - D. Laser cutting apertures with trapezoidal walls and also rounding corners will offer better paste release. Customers should contact their board assembly site for stencil design recommendations. Refer to IPC-7525
 - E. Customers should contact their board fabrication site for solder mask tolerances between and around signal pads.

IMPORTANT NOTICE AND DISCLAIMER

TI PROVIDES TECHNICAL AND RELIABILITY DATA (INCLUDING DATASHEETS), DESIGN RESOURCES (INCLUDING REFERENCE DESIGNS), APPLICATION OR OTHER DESIGN ADVICE, WEB TOOLS, SAFETY INFORMATION, AND OTHER RESOURCES "AS IS" AND WITH ALL FAULTS, AND DISCLAIMS ALL WARRANTIES, EXPRESS AND IMPLIED, INCLUDING WITHOUT LIMITATION ANY IMPLIED WARRANTIES OF MERCHANTABILITY, FITNESS FOR A PARTICULAR PURPOSE OR NON-INFRINGEMENT OF THIRD PARTY INTELLECTUAL PROPERTY RIGHTS.

These resources are intended for skilled developers designing with TI products. You are solely responsible for (1) selecting the appropriate TI products for your application, (2) designing, validating and testing your application, and (3) ensuring your application meets applicable standards, and any other safety, security, or other requirements. These resources are subject to change without notice. TI grants you permission to use these resources only for development of an application that uses the TI products described in the resource. Other reproduction and display of these resources is prohibited. No license is granted to any other TI intellectual property right or to any third party intellectual property right. TI disclaims responsibility for, and you will fully indemnify TI and its representatives against, any claims, damages, costs, losses, and liabilities arising out of your use of these resources.

TI's products are provided subject to TI's Terms of Sale (www.ti.com/legal/termsofsale.html) or other applicable terms available either on ti.com or provided in conjunction with such TI products. TI's provision of these resources does not expand or otherwise alter TI's applicable warranties or warranty disclaimers for TI products.

Mailing Address: Texas Instruments, Post Office Box 655303, Dallas, Texas 75265
Copyright © 2019, Texas Instruments Incorporated

Looking for pricing, stock, or lifecycle information?

Click below to explore more details on WIN SOURCE:

 [View CD4097BE](#) on WIN SOURCE

 [Texas Instruments](#) Information

Optimize Your Supply Chain with WIN SOURCE Solutions

-  Global Sourcing Solution
-  Obsolete Management
-  Cost Control Management
-  Shortage Management
-  Alternative Solution
-  Excess Inventory Management