

GL380/GL381

High Output, ϕ 3mm Resin Mold Type Infrared Emitting Diode

■ Features

- High output
(I_E : MIN. 4.5mW/sr at $I_F = 50\text{mA}$, **GL380**)
(I_E : MIN. 8.5mW/sr at $I_F = 50\text{mA}$, **GL381**)
- Compact ϕ 3mm resin mold package
- Narrow beam angle($\Delta\theta$: TYP. $\pm 13^\circ$)

■ Applications

- Floppy disk drives
- Optoelectronic switches
- Infrared applied systems

■ Absolute Maximum Ratings (Ta = 25°C)

Parameter	Symbol	Rating	Unit
Forward current	I_F	60	mA
*1Peak forward current	I_{FM}	1	A
Reverse voltage	V_R	6	V
Power dissipation	P	150	mW
Operating temperature	T_{opr}	- 25 to + 85	°C
Storage temperature	T_{stg}	- 40 to + 85	°C
*2Soldering temperature	T_{sol}	260	°C

*1 Pulse width $\leq 100\mu\text{s}$, Duty ratio = 0.01

*2 For 3 seconds at the position of 2.6mm from the bottom face of resin package.

■ Electro-optical Characteristics (Ta = 25°C)

Parameter	Symbol	Conditions	MIN.	TYP.	MAX.	Unit
Forward voltage	V_F	$I_F = 50\text{mA}$	-	1.3	1.5	V
Peak forward voltage	V_{FM}	$I_{FM} = 0.5\text{A}$	-	2.2	3.5	V
Reverse current	I_R	$V_R = 3\text{V}$	-	-	10	μA
*3Radiant intensity	GL380	$I_F = 50\text{mA}$	4.5	11	-	mW/sr
	GL381		8.5	20	-	
Peak emission wavelength	λ_P	$I_F = 5\text{mA}$	-	950	-	nm
Half intensity wavelength	$\Delta\lambda$	$I_F = 5\text{mA}$	-	45	-	nm
Terminal capacitance	C_t	$V_R = 0, f = 1\text{MHz}$	-	70	-	pF
Response frequency	f_C		-	300	-	kHz
Half intensity angle	$\Delta\theta$	$I_F = 20\text{mA}$	-	± 13	-	°

*3 I_E : Value obtained by converting the value in power of radiant fluxes at the solid angle of 0.01 sr(steradian)the direction of mechanical axis of the lens portion into 1 sr of all those emitted from the light emitting diode.

■ Outline Dimensions (Unit : mm)

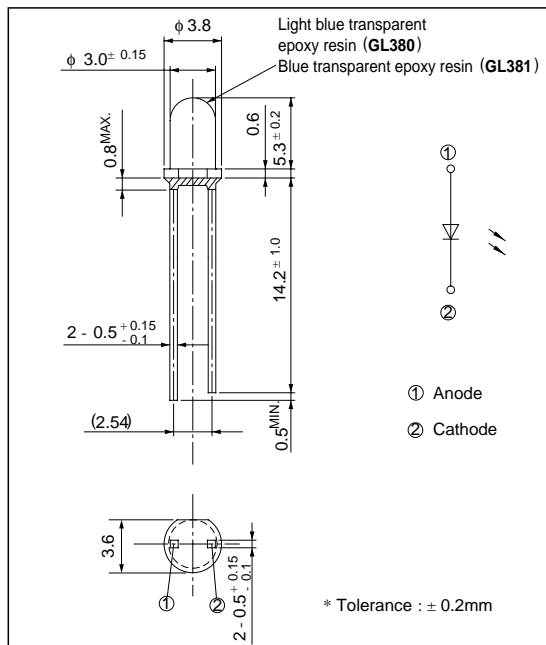

Fig. 1 Forward Current vs. Ambient Temperature

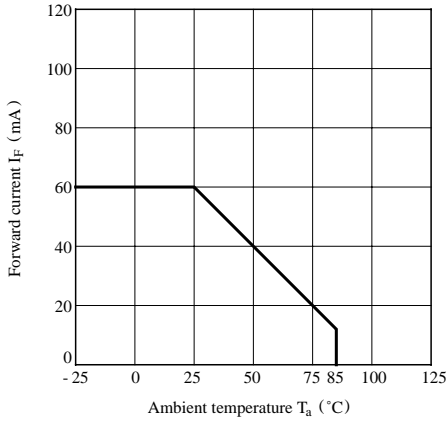

Fig. 2 Peak Forward Current vs. Duty Ratio

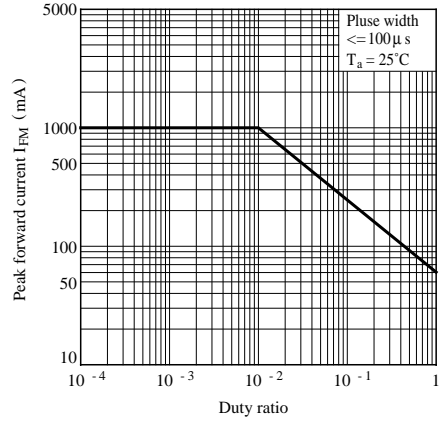

Fig. 3 Spectral Distribution

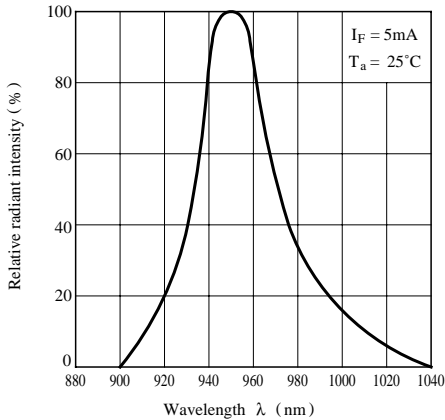

Fig. 4 Peak Emission Wavelength vs. Ambient Temperature

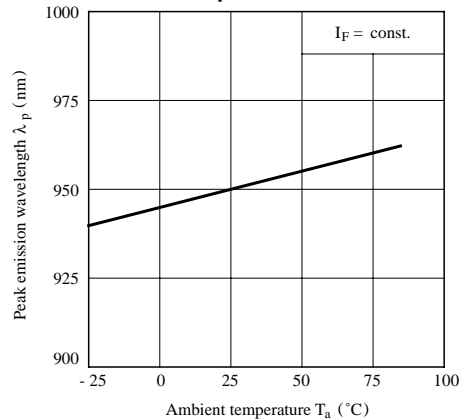

Fig. 5 Forward Current vs. Forward Voltage

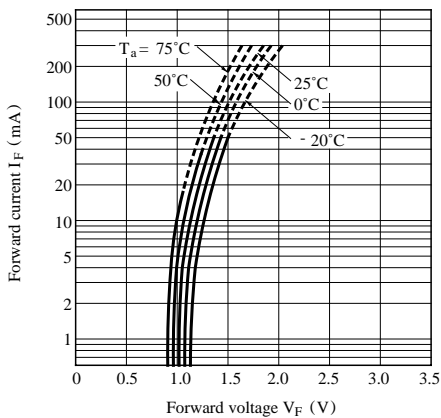

Fig. 6 Relative Radiant Flux vs. Ambient Temperature

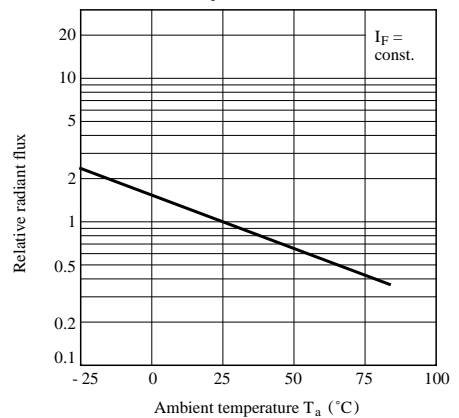

Fig. 7 Radiant Intensity vs. Forward Current

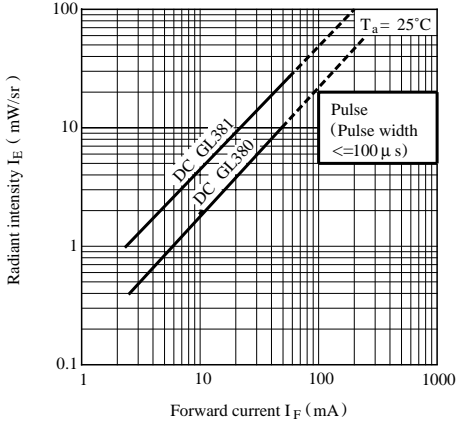

Fig. 8 Relative Collector Current vs. Distance
(Detector : PT380 / PT381)

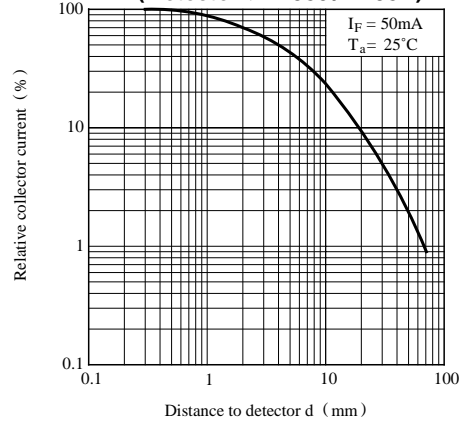
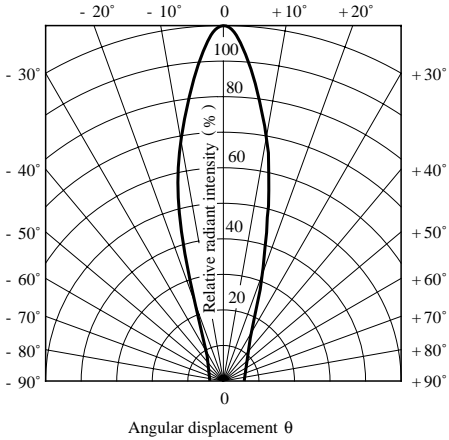



Fig. 9 Radiation Diagram









● Please refer to the chapter “Precautions for Use”

Looking for pricing, stock, or lifecycle information?

Click below to explore more details on WIN SOURCE:

-  [View GL380 on WIN SOURCE](#)
-  [Sharp Microelectronics Information](#)

Optimize Your Supply Chain with WIN SOURCE Solutions

-  Global Sourcing Solution
-  Obsolete Management
-  Cost Control Management
-  Shortage Management
-  Alternative Solution
-  Excess Inventory Management