



**THE DATASHEET OF  
FMY-1036S**



## 1. Scope

The present specifications shall apply to an FMY-1036S

## 2. Outline

Type	Silicon Diode
Structure	Resin Molded      Flammability : UL94V-0 (Equivalent)
Applications	High Frequency Rectification

## 3. Absolute maximum ratings

No.	Item	Symbol	Unit	Rating	Conditions
1	Transient Peak Reverse Voltage	$V_{RSM}$	V	600	
2	Peak Reverse Voltage	$V_{RM}$	V	600	
3	Average Forward Current	$I_{F(AV)}$	A	3	Refer to Derating of 6
4	Peak Surge Forward Current	$I_{FSM}$	A	50	Half sinewave, one shot
5	$I^2t$ Limiting Value	$I^2t$	$A^2s$	12.5	$1ms \leq t \leq 10ms$
6	Junction Temperature	$T_j$	$^{\circ}C$	-40~+150	
7	Storage Temperature	$T_{stg}$	$^{\circ}C$	-40~+150	

## 4. Electrical characteristics (Ta=25°C, unless otherwise specified)

No	Item	Symbol	Unit	Value	Conditions
1	Forward Voltage Drop	$V_F$	V	1.15 max.	$I_F = 3A$
2	Reverse Leakage Current	$I_R$	$\mu A$	10 max.	$V_R = V_{RM}$
3	Reverse Leakage Current Under High Temperature	$H \cdot I_R$	mA	1 max.	$V_R = V_{RM}, T_j = 150^{\circ}C$
4	Reverse Recovery Time	trr1	ns	200 max.	$I_F = I_{RP} = 100mA$ 90% Recovery point, $T_j = 25^{\circ}C$
		trr2	ns	100 max.	$I_F = 100mA, I_{RP} = 200mA$ 75% Recovery point, $T_j = 25^{\circ}C$
5	Thermal Resistance	$R_{th(j-c)}$	$^{\circ}C/W$	4.0 max.	Between Junction and case

5. Characteristics

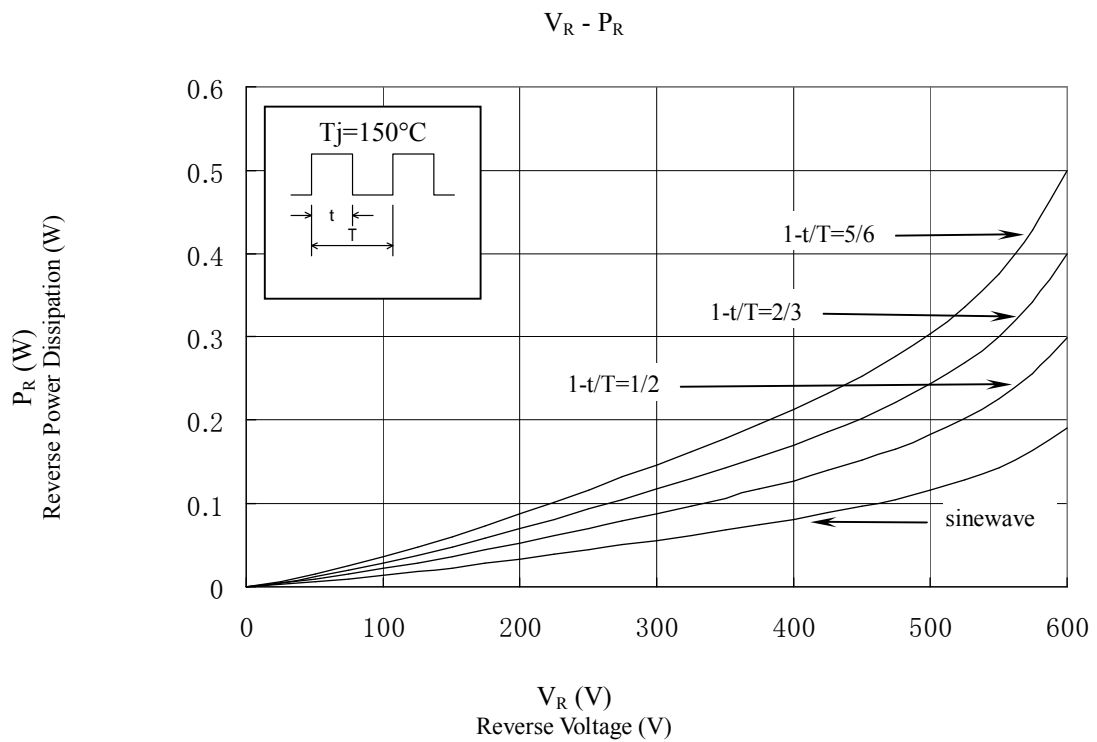
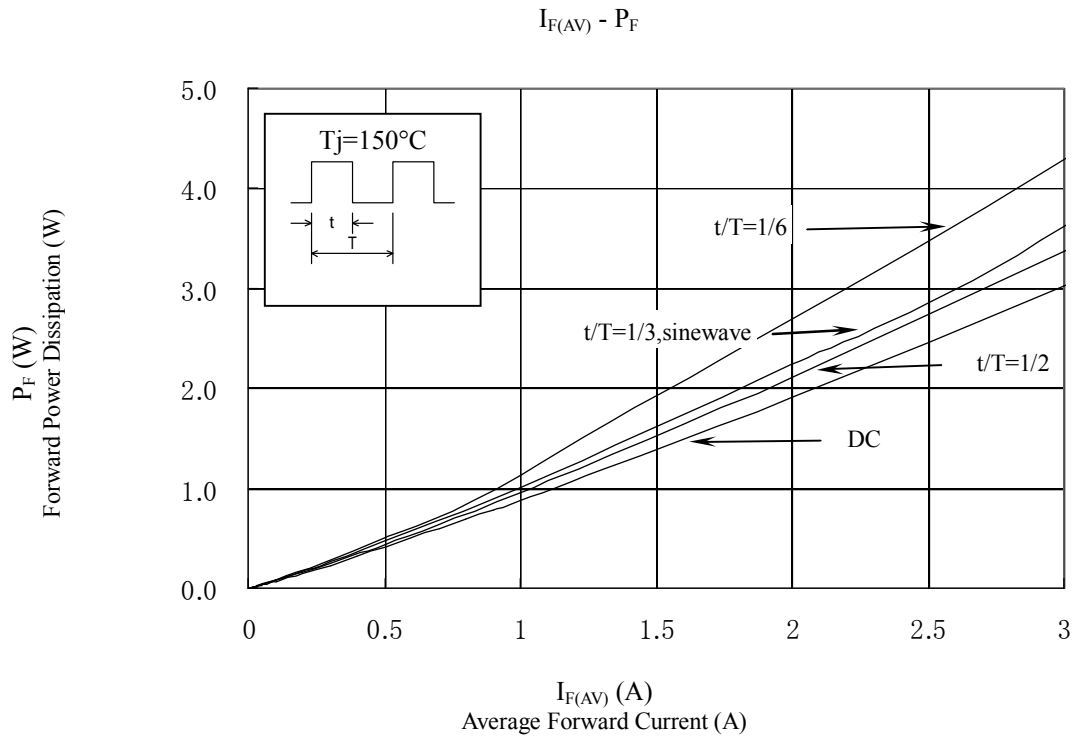

6. Derating

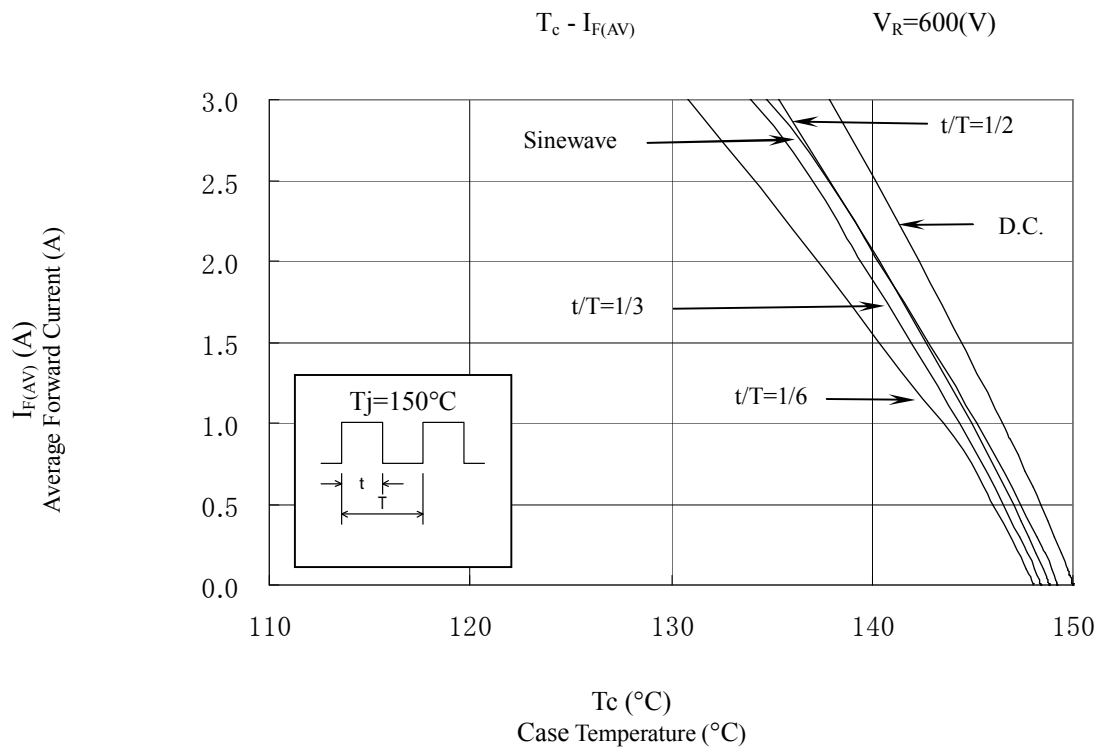
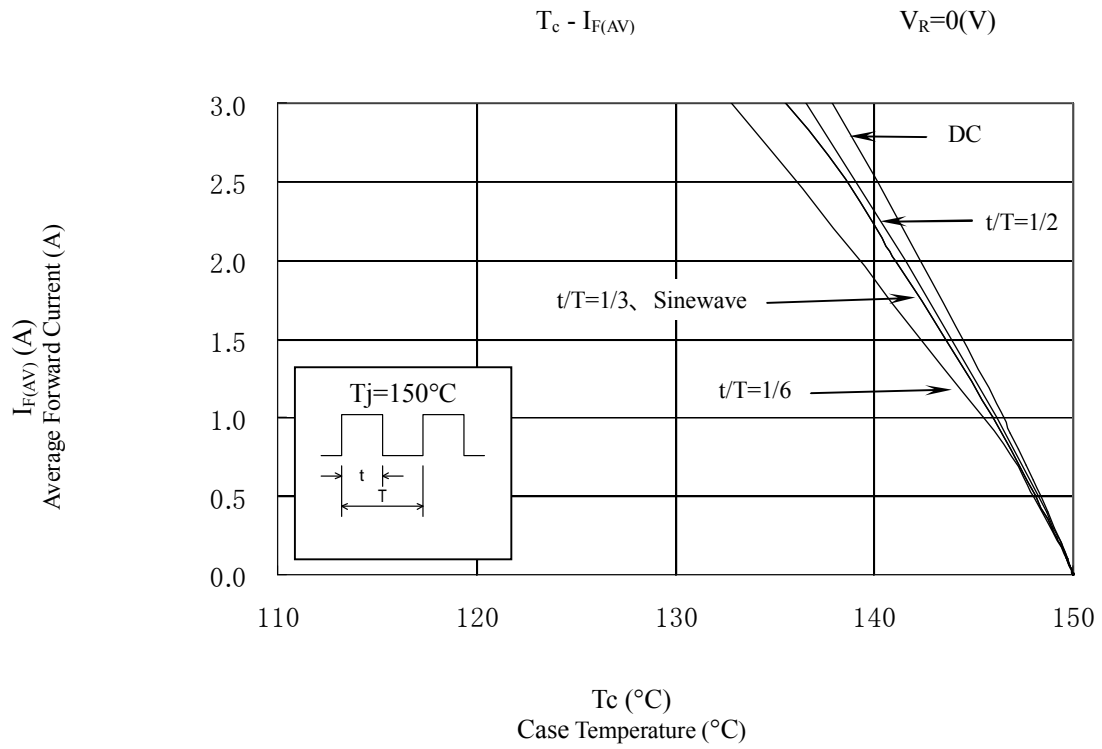

7. Package information

7-1 Package type, physical dimensions and material

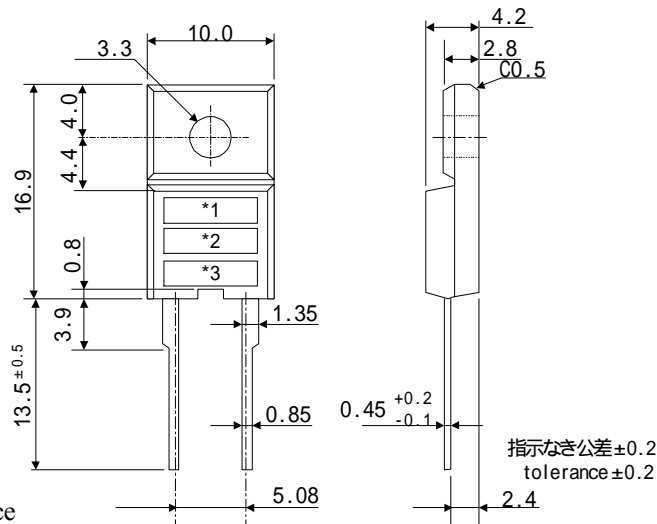

Dimensions in mm

7-2 Appearance

The body shall be clean and shall not bear any stain, rust or flaw.



7-3 Marking

Type Name	Marking		
	*1 Type Name	*2 Polarity	*3 Lot number
FMY-1036S	Y1036	S	1st letter: Last digit of year 2nd letter: Month From 1 to 9 for Jan. to Sep., O for Oct., N for Nov., D for Dec. 3rd & 4th letter: Day ex. 5O17 (Oct. 17, 2005)







## Looking for pricing, stock, or lifecycle information?

Click below to explore more details on WIN SOURCE:

-  [View FMY-1036S on WIN SOURCE](#)
-  [Sanken Information](#)

## Optimize Your Supply Chain with WIN SOURCE Solutions

-  Global Sourcing Solution
-  Obsolete Management
-  Cost Control Management
-  Shortage Management
-  Alternative Solution
-  Excess Inventory Management