





# THE DATASHEET OF KMB16F



**SPECIFICATION SHEET**

<b>SPECIFICATION SHEET NO.</b>	N0626-MBFKMB16FS1006
<b>DATE</b>	June 26, 2021
<b>REVISION</b>	A1
<b>DESCRIPTION</b>	SMD Schottky Bridge Rectifier, MBF series, KMB16F Type, 4 Pins, Reverse Voltage 60V Max. Forward Current 1.0A Max. Operating Temp. Range -55°C ~+125°C, Package in Tape/Reel, 5000pcs/Reel RoHS/RoHS III compliant
<b>CUSTOMER</b>	
<b>CUSTOMER PART NUMBER</b>	
<b>CROSS REF. PART NUMBER</b>	
<b>ORIGINAL PART NUMBER</b>	MDD KMB16F
<b>PART CODE</b>	MBFKMB16FS1006

<b>VENDOR APPROVE</b>			
Issued/Checked/Approved			
DATE: June 26, 2021			

<b>CUSTOMER APPROVE</b>	
DATE:	

**SMD BRIDGE RECTIFIER MBF SERIES**



**MAIN FEATURE**

- Surge overload rating: 30A peak
- Low leakage
- Reliable low cost construction utilizing molded
- Plastic material – UL flammability 94V-0

**APPLICATION**

- For SMD application

**RFQ**

[Request For Quotation](#)

**PART CODE GUIDE**

MBF	KMB16F	S	1006
1	2	3	4

- 1) **MBF**: SMD Schottky Bridge Rectifier, MBF series
- 2) **KMB16F**: Type code for original part number KMB16F
- 3) **S**: Package code, Tape/reel, 5000pcs/reel.
- 4) **1006**: Specification code for Reverse Voltage 60V Max. Forward Current 1.0A Max.

**MORE ITEMS AVAILABLE**

MBFKMB14FS1004	<b>MBFKMB16FS1006</b>	MBFKMB18FS1008	MBFKMB110FS110	MBFKMB115FS115
MBFKMB120FS120				

**SMD BRIDGE RECTIFIER MBF SERIES**

**DIMENSION (Unit: Inch/mm)**

Image for reference

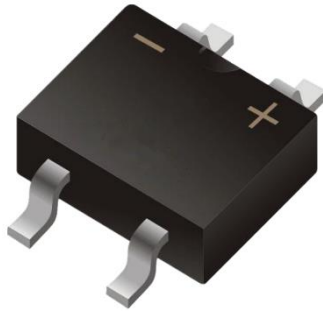

Marking: KMB16F

MBF

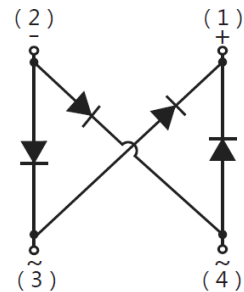
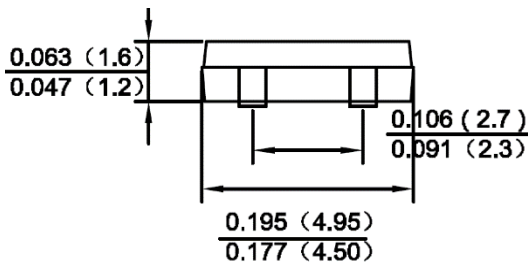
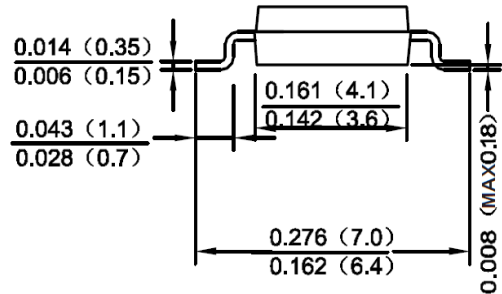
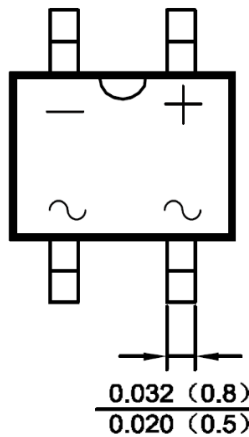

Recommend Pad Layout

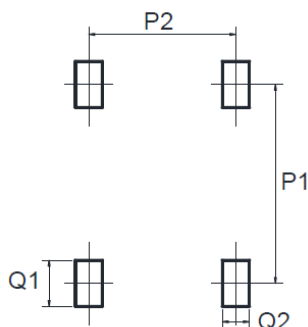

Symbol	Min. (Inch)	Min. (mm)
P1	0.236	6.00
P2	0.094	2.40
Q1	0.072	1.84
Q2	0.047	1.20

**SMD BRIDGE RECTIFIER MBF SERIES**
**MECHANICAL DATA**

Case	Terminals	Polarity	Mounting Position	Weight per piece
JEDEC MBF molded plastic body	Solder plated, Solderable per MIL-STD-750, Method 2026	Polarity symbol marking on case	Any	0.0026 Ounce, 0.075 grams

**MAX. RATING & CHARACTERISTICS**

Parameter	SYMBOLS	VALUE			UNITS
		Min.	Typical	Max.	
Repetitive peak reverse voltage	V <sub>RRM</sub>			60	Volts
RMS voltage	V <sub>RMS</sub>			42	Volts
DC blocking voltage	V <sub>DC</sub>			60	Volts
Average forward output rectified current at T <sub>c</sub> = 30°C, Aluminum Substrate	I <sub>AV</sub>			1.0	A
Peak forward surge current 8.3ms single half sine-wave superimposed on rated load (JEDEC Method)	I <sub>FSM</sub>		30		A
Instantaneous forward voltage at 1A	V <sub>F</sub>			0.70	Volts
DC reverse current at rated DC blocking voltage	I <sub>R</sub>			0.3	μA
				10	
Junction capacitance	C <sub>J</sub>		80		pF
Thermal resistance (Note 2)	R <sub>QJA</sub>		100		°C/W
Operating junction temperature range	T <sub>J</sub>	-55		+125	
Storage temperature range	T <sub>STG</sub>	-55		+150	°C

**Note**

- Ratings at 25 C ambient temperature unless otherwise specified. Single phase half-wave 60Hz, resistive or inductive load, for capacitive load current derate by 20%.
- Thermal resistance from junction to ambient and from junction to lead PCB mounted on 02"\*0.2" copper pad areas.

**SMD BRIDGE RECTIFIER MBF SERIES**

**RELIABILITY**

Number	Experiment Items	Experiment Method And Conditions	Reference Documents
1	Solder Resistance Test	Test 260°C± 5°C for 10 ± 2 sec. Immerse body into solder 1/16" ± 1/32"	MIL-STD-750D METHOD-2031.2
2	Solderability Test	230°C ±5°C for 5 sec.	MIL-STD-750D METHOD-2026.1 0
3	Pull Test	1 kg in axial lead direction for 10 sec.	MIL-STD-750D METHOD-2036.4
4	Bend Test	0.5Kg Weight Applied To Each Lead, Bending Arcs 90 °C ± 5 °C For 3 Times	MIL-STD-750D METHOD-2036.4
5	High Temperature Reverse Bias Test	TA=100°C for 1000 Hours at VR=80% Rated VR	MIL-STD-750D METHOD-1038.4
6	Forward Operation Life Test	TA=25°C Rated Average Rectified Current	MIL-STD-750D METHOD-1027.3
7	Intermittent Operation Life Test	On state: 5 min with rated IRMS Power Off state: 5 min with Cool Forced Air. On and off for 1000 cycles.	MIL-STD-750D METHOD-1036.3
8	Pressure Cooker Test	15 PSIG, TA=121°C, 4 hours	MIL-S-19500 APPENIOXC
9	Temperature Cycling Test	-55°C~+125°C; 30 Minutes For Dwelled Time 5 minutes for transferred time. Total: 10 cycles.	MIL-STD-750D METHOD-1051.7
10	Thermal Shock Test	0°C for 5 minutes., 100°C for 5minutes, Total: 10 cycles	MIL-STD-750D METHOD-1056.7
11	Forward Surge Test	8.3ms Single Sale Sine-wave One Surge.	MIL-STD-750D METHOD-4066.4
12	Humidity Test	TA=65°C, RH=98% for 1000 hours.	MIL-STD-750D METHOD-1021.3
13	High Temperature Storage life Test	150°C for 1000 Hours	MIL-STD-750D METHOD-1031.5

**SUGGESTED REFLOW PROFILE (For Reference Only)**

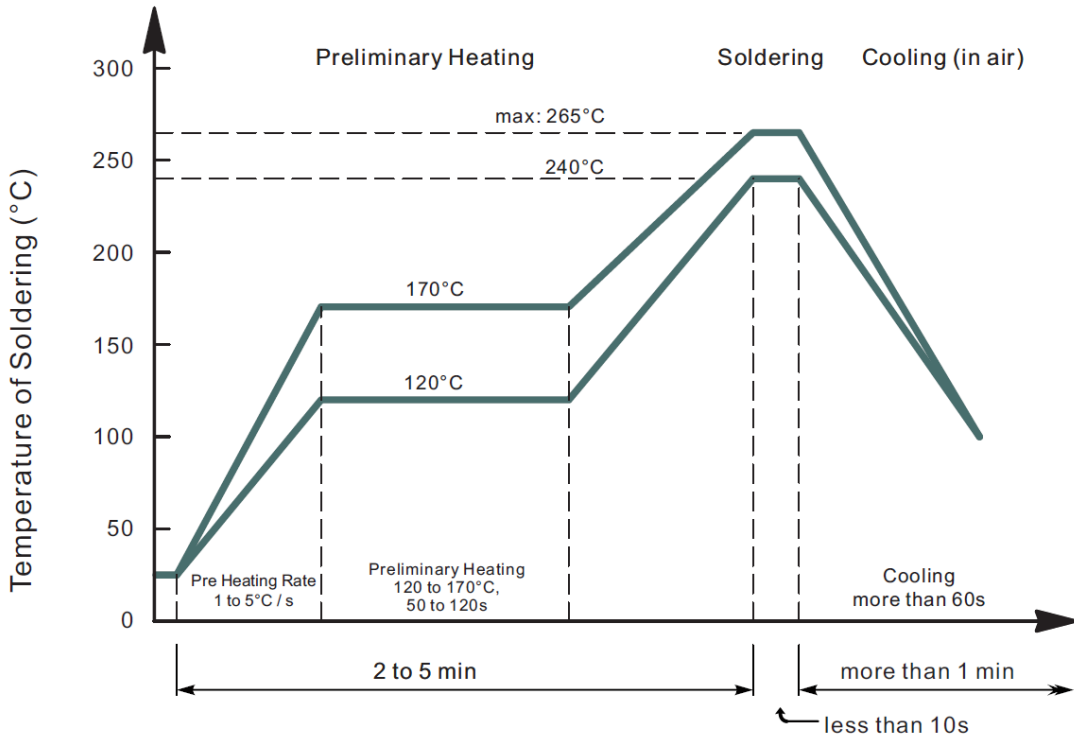

- Recommended peak temperature is over 245°C, If peak temperature is below 245 °C, you may adjust the following parameters; time length of peak temperature (longer), time length of soldering (longer), thickness of solder paste (thicker)
- Welding shall not exceed 2 times
- Remark: lead free solder paste (96.5 sn/3.0 Ag/0.5Cu)

**RATINGS AND CHARACTERISTIC CURVES (For Reference Only)**

Fig.1 Forward Current Derating Curve

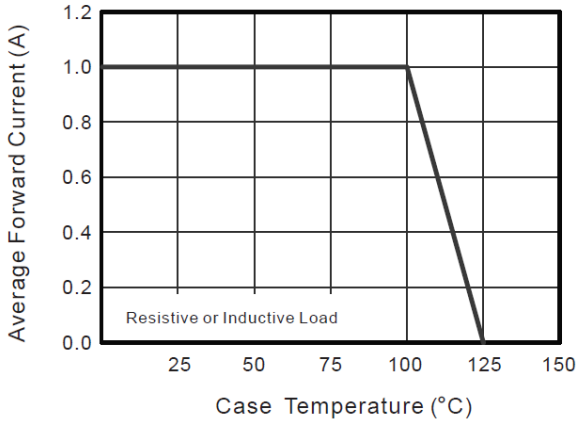

Fig.2 Typical Reverse Characteristics

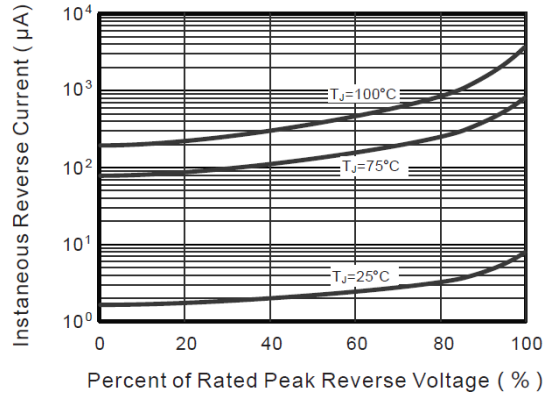

Fig.3 Typical Forward Characteristic

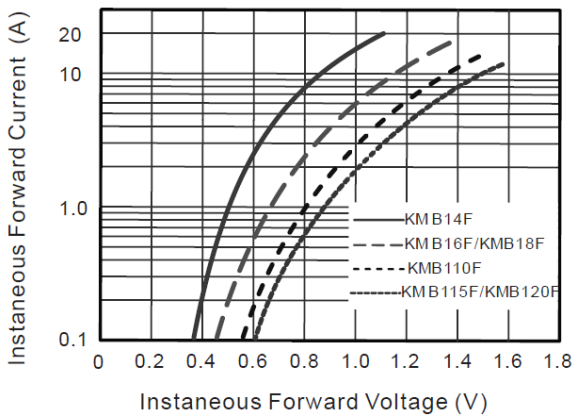

Fig.4 Typical Junction Capacitance

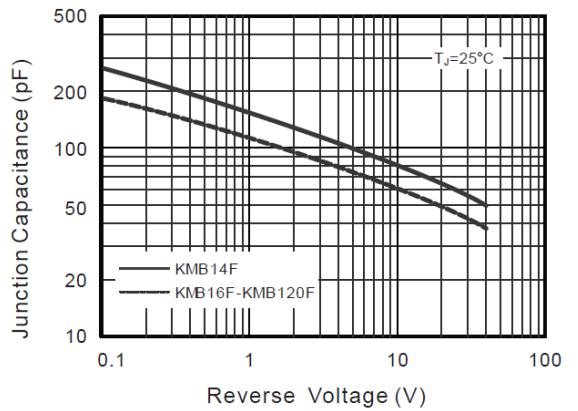

Fig.5 Maximum Non-Repetitive Peak Forward Surge Current

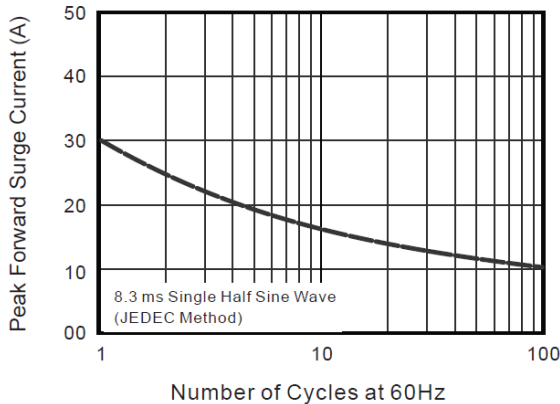
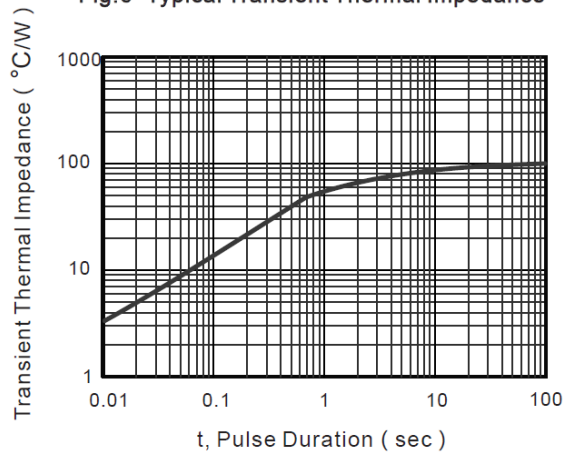

Fig.6- Typical Transient Thermal Impedance



**SMD BRIDGE RECTIFIER MBF SERIES**

**TAPE/REEL (Unit: mm)**

All Devices are packed in accordance with EIA standard RS-481-A and specifications.

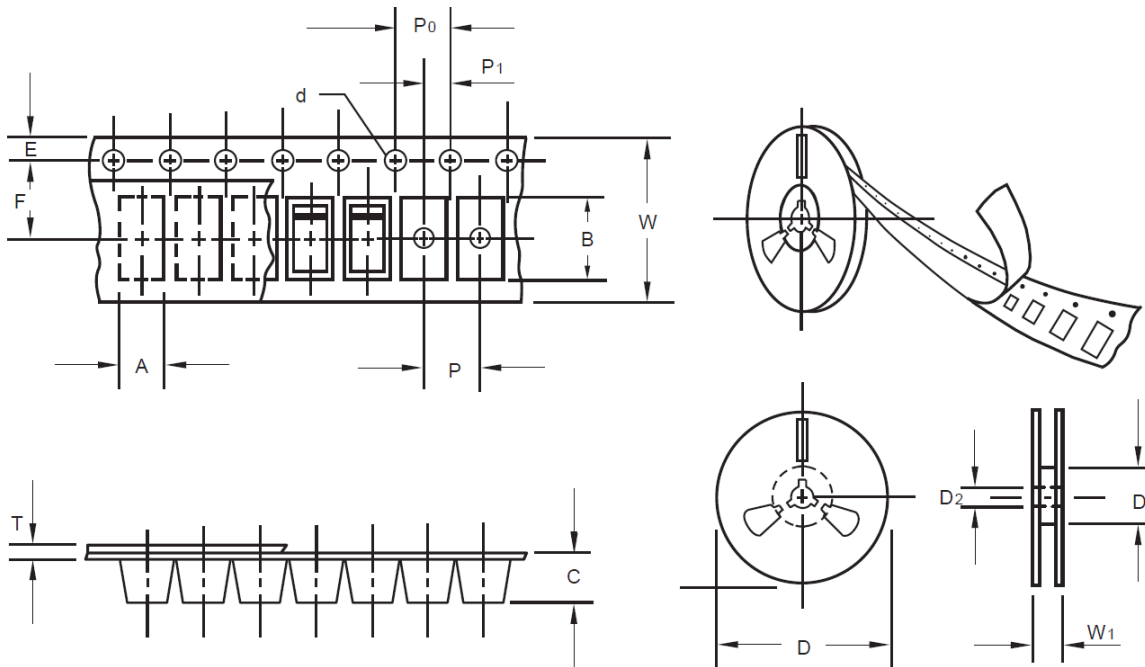

Item	Symbol	Tolerance	MBF
Carrier width	A	0.1	2.8
Carrier Length	B	0.1	5.33
Carrier Depth	C	0.1	2.36
Sprocket hole	d	0.05	1.50
13"Reel outside diameter	D	2.0	330.00
13"Reel inner diameter	D1	Min.	50.00
7"Reel outside diameter	D	-	-
7"Reel inner diameter	D1	-	-
Feed hole diameter	D2	0.5	13.00
Sprocket hole position	E	0.1	1.75
Punch hole position	F	0.1	5.50
Punch hole pitch	P	0.1	4.00
Sprocket hole pitch	P0	0.1	4.00
Embossment center	P1	0.1	2.0
Overall tape thickness	T	0.1	0.28
Tape width	W	0.3	12.00
Reel width	W1	1.0	18.0

**SMD BRIDGE RECTIFIER MBF SERIES**

**PACKAGE**

Case Code	Reel Size	MPQ (pcs)	Component Spacing (mm)	Qty. Per Box (pcs)	Inner Box L*W*H (mm)	Reel Size (mm)	Carton size L*W*H (mm)	Qty. Per Carton (pcs)	G. W (kg)
MBF	13"	5,000	-	10,000	335*340*40	330	380*380*380	80,000	14.4

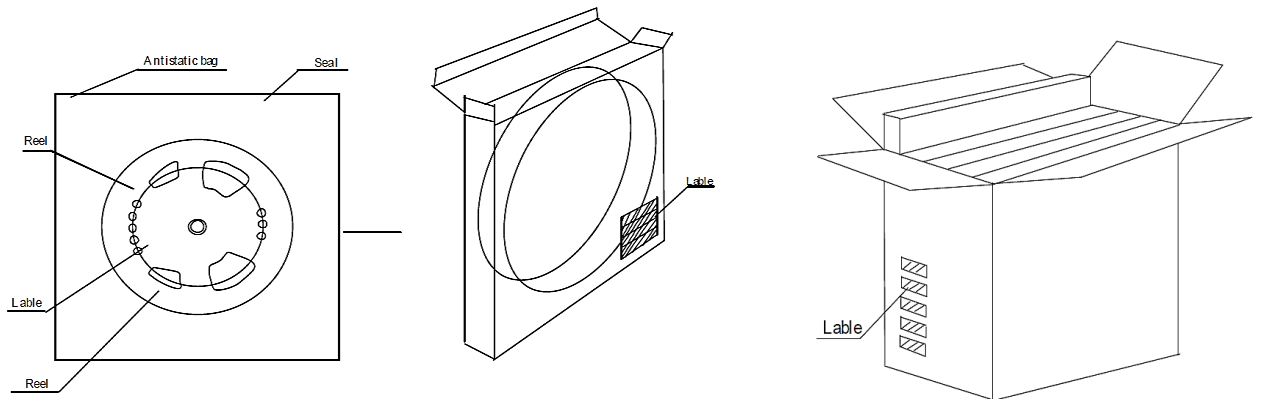

**DISCLAIMER**

NextGen Component, Inc. reserves the right to make changes to the product(s) and or information contained herein without notice. No liability is assumed as a result of their use or application. No rights under any patent accompany the sale of any such product(s) or information







## Looking for pricing, stock, or lifecycle information?

Click below to explore more details on WIN SOURCE:

 [View KMB16F on WIN SOURCE](#)

 [MDD Information](#)

## Optimize Your Supply Chain with WIN SOURCE Solutions

-  Global Sourcing Solution
-  Obsolete Management
-  Cost Control Management
-  Shortage Management
-  Alternative Solution
-  Excess Inventory Management