



**THE DATASHEET OF  
HMC622LP4E**





## GaAs MMIC MIXER w/ INTEGRATED IF & LO AMPLIFIER, 1.8 - 3.9 GHz

### Typical Applications

The HMC622LP4 / HMC622LP4E is ideal for:

- PCS / 3G Infrastructure
- Base Stations & Repeaters
- WiMAX & WiBro
- Broadband & Fixed Wireless

### Features

- High Input IP3: +23 dBm
- Low Input LO Drive: 0 to +6 dBm
- High LO to RF Isolation: 33 dB
- High Conversion Gain: 9 dB
- Can be used for upconversion or downconversion
- 24 Lead 4x4mm SMT Package: 16mm<sup>2</sup>

### Functional Diagram

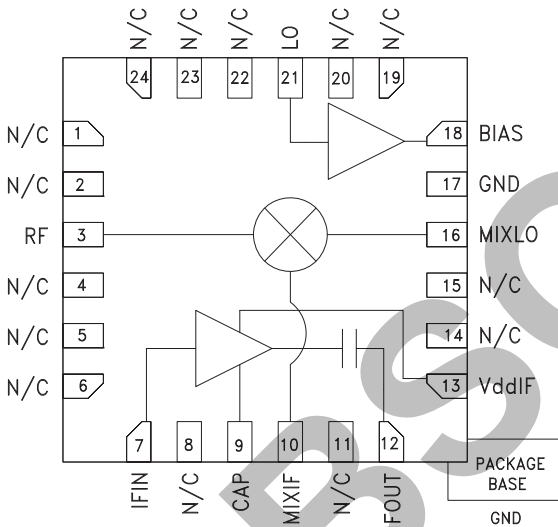

### General Description

The HMC622LP4E is a highly integrated converter IC that operates from 1.8 to 3.9 GHz for both up-conversion and downconversion applications. The HMC622LP4E incorporates a high dynamic range, double-balanced mixer core with integrated LO and IF amplifiers, making it ideal for compact transceiver applications in GSM, WCDMA, TD-SCDMA, WiBro and WiMAX. This versatile converter RFIC operates with a low LO input power level of only +3 dBm, provides up to 10 dB conversion gain, and exhibits +23 dBm Input IP3 in downconversion mode. This RFIC provides up to 12 dB conversion gain in upconverter mode. Specific evaluation boards are available for both upconversion and downconversion modes.

### Electrical Specifications, $T_A = +25^\circ\text{C}$ , LO = +3 dBm, VddIF = BIAS = +5V\*

Parameter	Min.	Typ.	Max.	Units
Frequency Range, RF, LO	1.8 - 3.9			GHz
Frequency Range, IF	200 - 550			MHz
Conversion Gain	5	9		dB
Noise Figure (SSB), IF=468 MHz		10		dB
LO to RF Isolation	27	33		dB
LO to IF Isolation	3	11		dB
IP3 (Input)		23		dBm
1 dB Compression (Input), IF=400 MHz		12		dBm
LO Drive Input Level (Typical)	0 to +6			dBm
Supply Current (IddIF + IBIAS)		175	220	mA

\*Unless otherwise noted, all measurements performed as a downconverter and configured as shown in the downconverter mode application circuit, IF=250 MHz



**GaAs MMIC MIXER w/ INTEGRATED IF & LO AMPLIFIER, 1.8 - 3.9 GHz**

**Conversion Gain vs. Temperature**

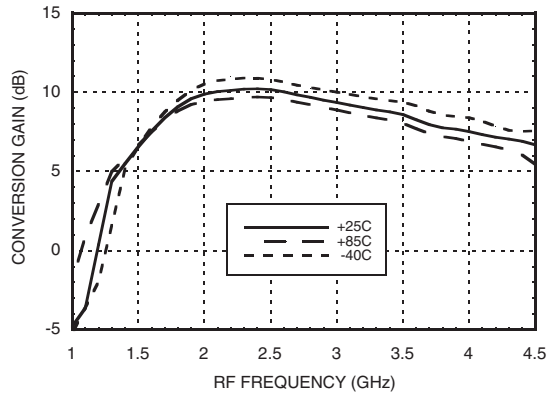

**Isolation**

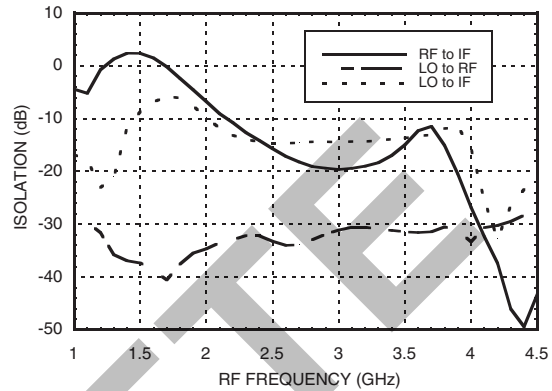

**Conversion Gain vs. LO Drive**

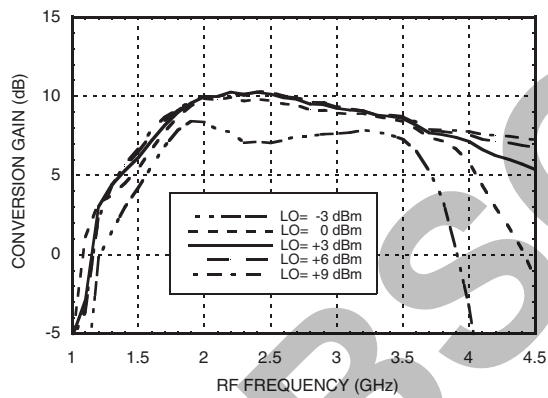

**Return Loss**

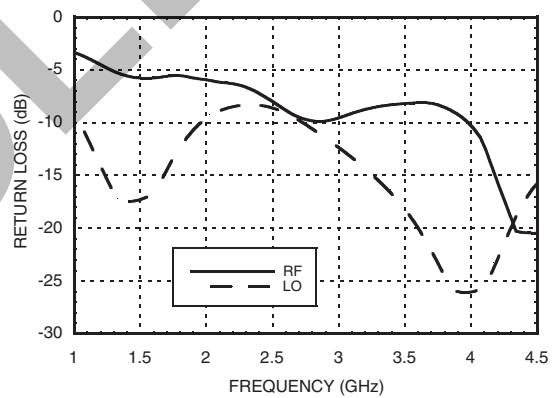

**Upconverter Performance  
Conversion Gain vs. LO Drive**

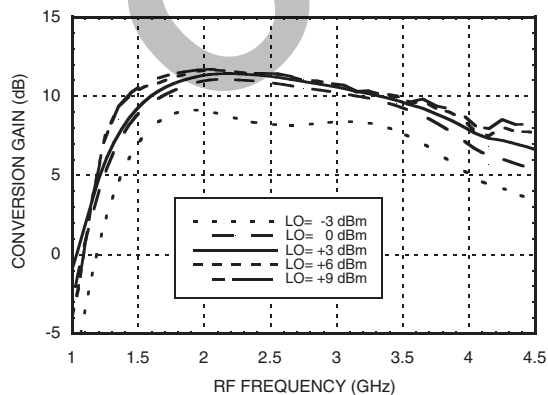

**IF Bandwidth, LO = 2 GHz**

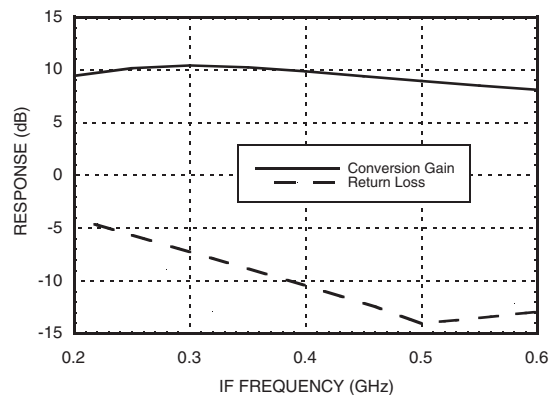

Information furnished by Analog Devices is believed to be accurate and reliable. However, no responsibility is assumed by Analog Devices for its use, nor for any infringements of patents or other rights of third parties that may result from its use. Specifications subject to change without notice. No license is granted by implication or otherwise under any patent or patent rights of Analog Devices. Trademarks and registered trademarks are the property of their respective owners.

For price, delivery, and to place orders: Analog Devices, Inc., One Technology Way, P.O. Box 9106, Norwood, MA 02062-9106 Phone: 781-329-4700 • Order online at [www.analog.com](http://www.analog.com) Application Support: Phone: 1-800-ANALOG-D



**GaAs MMIC MIXER w/ INTEGRATED  
IF & LO AMPLIFIER, 1.8 - 3.9 GHz**

**Input IP3 vs. Temperature**

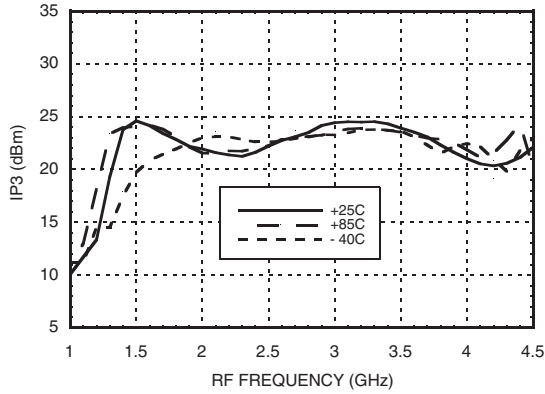

**Input IP3 vs. LO Drive**

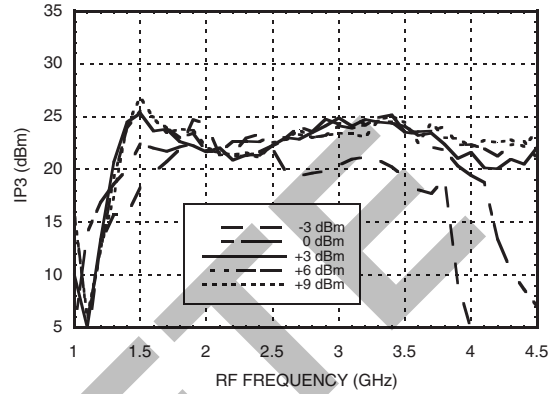

**Input IP2 vs. Temperature**

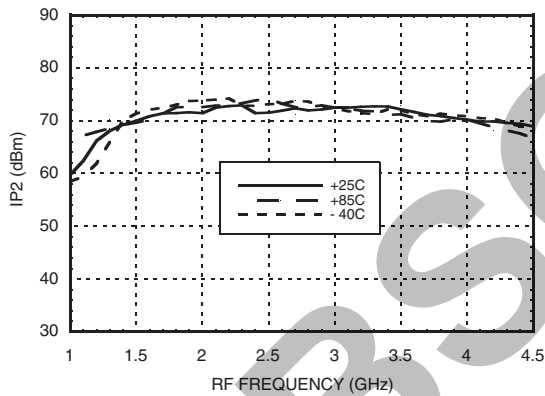

**Input IP2 vs. LO Drive**

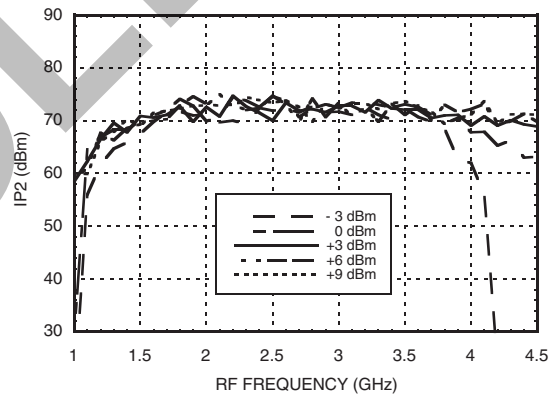

**Input P1dB vs. Temperature, IF= 250 MHz**

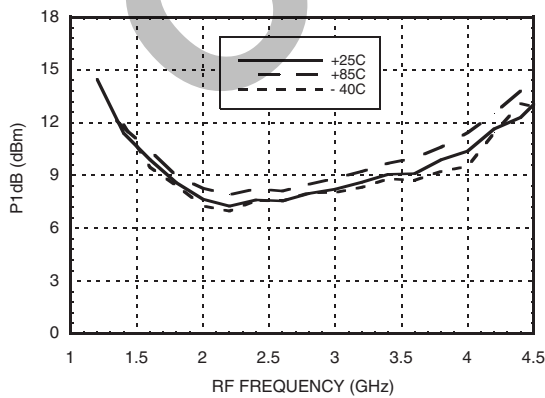

**Input P1dB vs. Temperature, IF= 400 MHz**

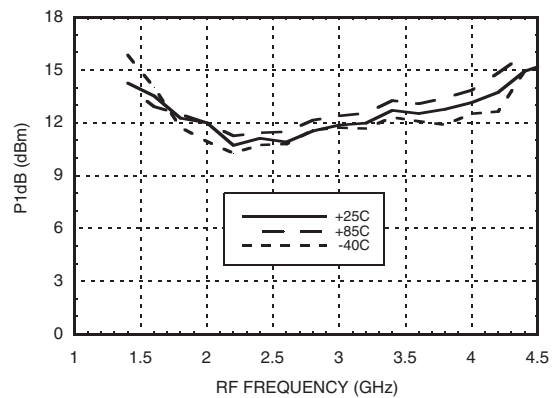

Information furnished by Analog Devices is believed to be accurate and reliable. However, no responsibility is assumed by Analog Devices for its use, nor for any infringements of patents or other rights of third parties that may result from its use. Specifications subject to change without notice. No license is granted by implication or otherwise under any patent or patent rights of Analog Devices. Trademarks and registered trademarks are the property of their respective owners.

For price, delivery, and to place orders: Analog Devices, Inc., One Technology Way, P.O. Box 9106, Norwood, MA 02062-9106 Phone: 781-329-4700 • Order online at [www.analog.com](http://www.analog.com) Application Support: Phone: 1-800-ANALOG-D

**GaAs MMIC MIXER w/ INTEGRATED  
IF & LO AMPLIFIER, 1.8 - 3.9 GHz**
**MxN Spurious @ IF Port**

mRF	nLO				
	0	1	2	3	4
0	xx	1	38	18	336
1	6	0	27	47	66
2	83	47	41	57	68
3	114	113	74	60	77
4	118	119	119	94	99

RF Freq. = 2.1 GHz @ -10 dBm  
LO Freq. = 2.0 GHz @ +3 dBm  
All values in dBc relative to the IF power level.

**Harmonics of LO**

LO Freq. (GHz)	nLO Spur @ RF Port			
	1	2	3	4
1.4	39	20	26	37
1.6	35	17	28	27
1.8	34	17	38	38
2.0	32	17	33	42
2.2	33	18	27	44
2.6	33	26	35	41
3.0	31	17	38	40
3.4	33	19	37	39
3.8	31	26	38	43

LO = +3 dBm  
All values in dBc below input LO level measured at RF port.

**Absolute Maximum Ratings**

RF / MIX IF Input (VddIF = +5V)	+22 dBm
LO Drive (BIAS = +5V)	+10 dBm
IFIN	+15 dBm
BIAS	+7 Vdc
Vdd IF	+8 Vdc
Junction Temperature	150 °C
Continuous Pdiss (T = 85°C) (derate 14.9 mW/°C above 85°C)	0.97 W
Thermal Resistance (junction to ground paddle)	67.2 °C/W
Storage Temperature	-65 to +150°C
Operating Temperature	-40 to +85°C
ESD Sensitivity (HBM)	Class 1A

**Typical Supply Current**

VddIF, BIAS	IddIF + IBIAS
+5	175 mA



**ELECTROSTATIC SENSITIVE DEVICE  
OBSERVE HANDLING PRECAUTIONS**



**GaAs MMIC MIXER w/ INTEGRATED IF & LO AMPLIFIER, 1.8 - 3.9 GHz**

**Outline Drawing**

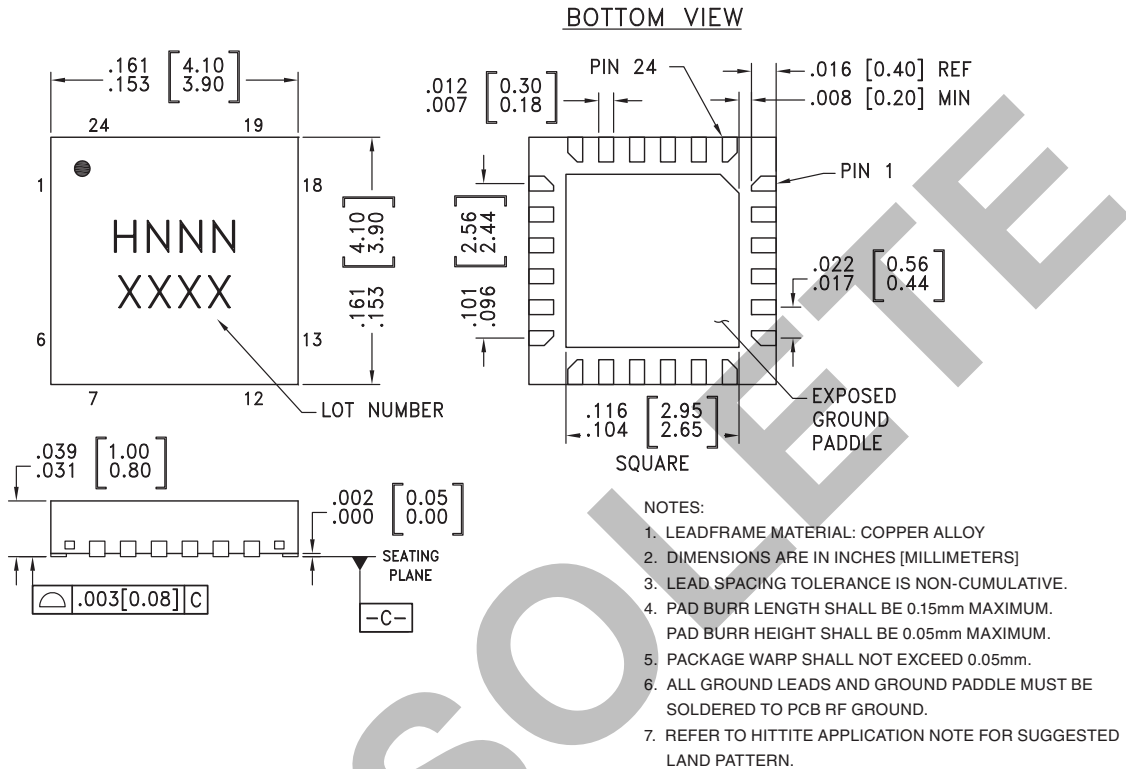

**Package Information**

Part Number	Package Body Material	Lead Finish	MSL Rating	Package Marking <sup>[3]</sup>
HMC622LP4	Low Stress Injection Molding Plastic	Sn/Pb Solder	MSL1 <sup>[1]</sup>	H622 XXXX
HMC622LP4E	RoHS-compliant Low Stress Injection Molding Plastic	100% matte Sn	MSL1 <sup>[2]</sup>	H622 XXXX

[1] Max peak reflow temperature of 235 °C  
 [2] Max peak reflow temperature of 260 °C  
 [3] 4-Digit lot number XXXX

**Pin Descriptions**



Pin Number	Function	Description	Interface Schematic
1, 2, 4, 5, 6, 8, 11, 14, 15, 19, 20, 22 - 24	N/C	No connection. These pins may be connected to RF ground. Performance will not be affected.	
3	RF	This pin is DC coupled and matched to 50 Ohms.	

Information furnished by Analog Devices is believed to be accurate and reliable. However, no responsibility is assumed by Analog Devices for its use, nor for any infringements of patents or other rights of third parties that may result from its use. Specifications subject to change without notice. No license is granted by implication or otherwise under any patent or patent rights of Analog Devices. Trademarks and registered trademarks are the property of their respective owners.

For price, delivery, and to place orders: Analog Devices, Inc., One Technology Way, P.O. Box 9106, Norwood, MA 02062-9106 Phone: 781-329-4700 • Order online at [www.analog.com](http://www.analog.com) Application Support: Phone: 1-800-ANALOG-D

**GaAs MMIC MIXER w/ INTEGRATED  
IF & LO AMPLIFIER, 1.8 - 3.9 GHz**

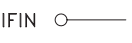
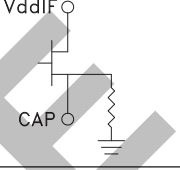
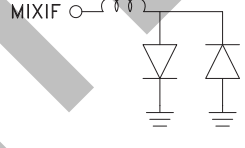
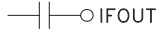
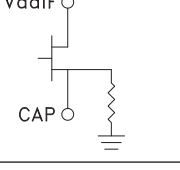
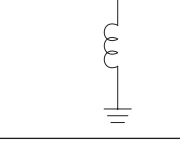
**Pin Descriptions (Continued)**

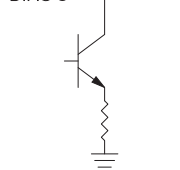
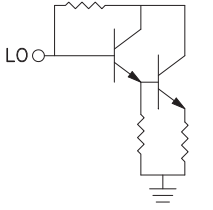
Pin Number	Function	Description	Interface Schematic
7	IFIN	This pin is matched to 50 ohms with a 51nH inductor to ground. See Application Circuit.	IFIN 
9	CAP	AC ground. An external capacitor of 0.01 $\mu$ F to ground is required for low frequency bypassing. See application circuit for further details.	VddIF 
10	MIXIF	This pin is DC coupled. For applications not requiring operation to DC, this port should be DC blocked externally using a series capacitor whose value has been chosen to pass the necessary IF frequency range. For operation to DC, this pin must not source/sink more than 18 mA of current or part non-function and possible part failure will result.	MIXIF 
12	IFOUT	This pin is AC coupled and matched to 50 Ohms.	 IFOUT
13	VddIF	Power supply for IF amplifier. Choke inductor and bypass capacitor are required. See application circuit.	VddIF 
16	MIXLO	This pin is DC coupled and matched to 50 Ohms. An off chip DC blocking capacitor is required.	MIXLO 
17	GND	Backside of package has exposed metal ground paddle that must also be connected to ground.	GND 
18	BIAS	Power supply and RF Output of the LO amplifier. Three external bypass capacitors are recommended for optimum performance, as illustrated in the application circuit.	BIAS 
21	LO	This pin is DC coupled and matched to 50 Ohms. An off chip DC blocking capacitor is required. See application circuit.	LO 

**GaAs MMIC MIXER w/ INTEGRATED  
IF & LO AMPLIFIER, 1.8 - 3.9 GHz**



**Evaluation PCB - Upconverter Mode**

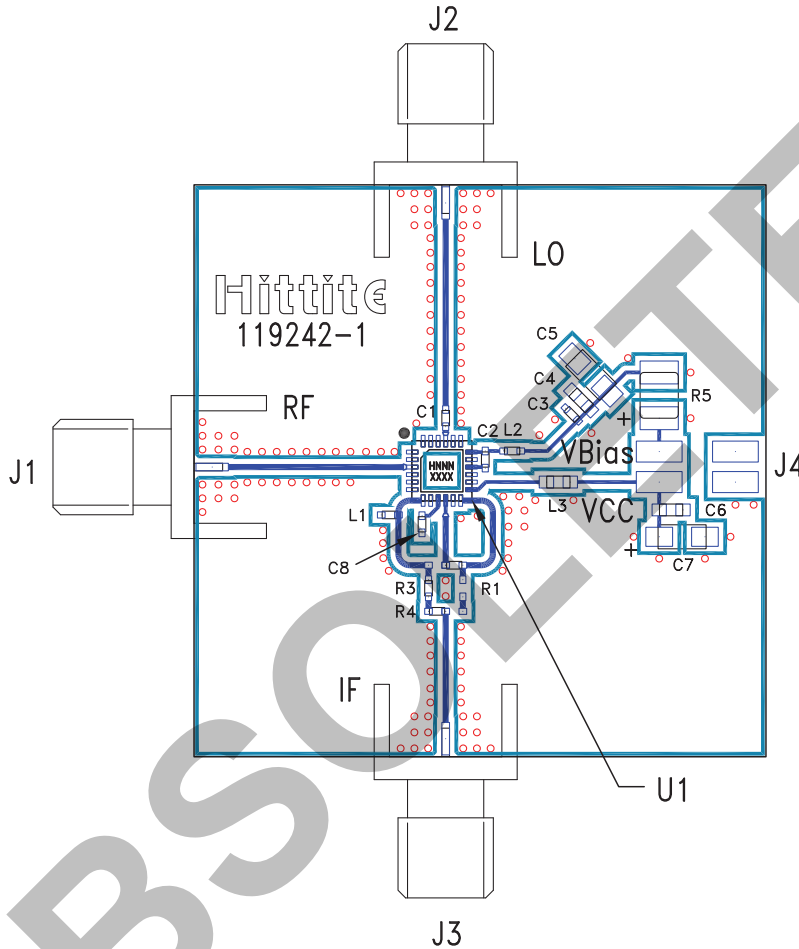

**List of Materials for Evaluation PCB 119244 [1]**

Item	Description
J1 - J3	PCB Mount SMA RF Connector
J4	DC Pin
C1, C2, C3	100 pF Chip Capacitor, 0402 Pkg.
C4, C6	1000 pF Chip Capacitor, 0603 Pkg.
C5, C7	2.2 $\mu$ F Capacitor, Tantalum
C8	0.01 $\mu$ F Chip Capacitor, 0402 Pkg.
L1	51 nH Chip Inductor, 0402 Pkg.
L2	18 nH Chip Inductor, 0402 Pkg.
L3	36 nH Chip Inductor, 0603 Pkg.
R1, R3, R4	0 Ohm Resistor, 0402 Pkg.
R5	18 Ohm Resistor, 1210 Pkg.
U1	HMC622LP4(E) - Upconverter
PCB [2]	119242 Evaluation Board

The circuit board used in the final application should use RF circuit design techniques. Signal lines should have 50 ohm impedance while the package ground leads and exposed paddle should be connected directly to the ground plane similar to that shown. A sufficient number of via holes should be used to connect the top and bottom ground planes. The evaluation circuit board shown is available from Hittite upon request.

[1] Reference this number when ordering complete evaluation PCB

[2] Circuit Board Material: Rogers 4350

**GaAs MMIC MIXER w/ INTEGRATED  
IF & LO AMPLIFIER, 1.8 - 3.9 GHz**

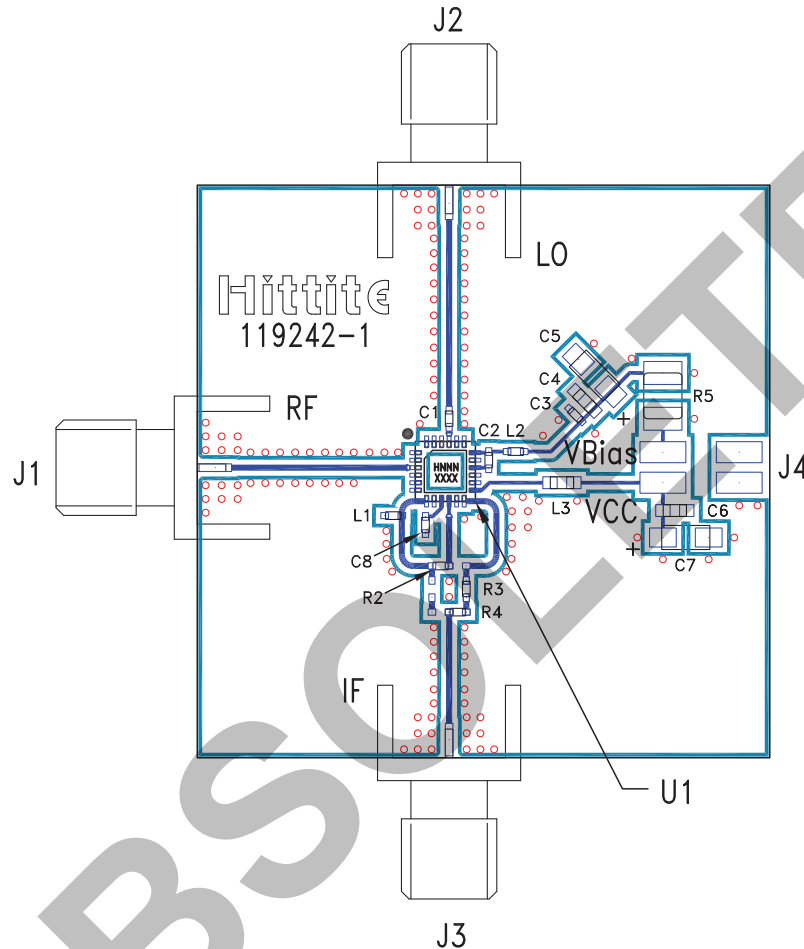
**Evaluation PCB - Downconverter Mode**

**List of Materials for Evaluation PCB 119328 [1]**

Item	Description
J1 - J3	PCB Mount SMA RF Connector
J4	DC Pin
C1, C2, C3	100 pF Chip Capacitor, 0402 Pkg.
C4, C6	1000 pF Chip Capacitor, 0603 Pkg.
C5, C7	2.2 $\mu$ F Capacitor, Tantalum
C8	0.01 $\mu$ F Chip Capacitor, 0402 Pkg.
L1	51 nH Chip Inductor, 0402 Pkg.
L2	18 nH Chip Inductor, 0402 Pkg.
L3	36 nH Chip Inductor, 0603 Pkg.
R2, R3, R4	0 Ohm Resistor, 0402 Pkg.
R5	18 Ohm Resistor, 1210 1/8 watt Pkg.
U1	HMC622LP4(E) - Downconverter
PCB [2]	119242 Evaluation Board

[1] Reference this number when ordering complete evaluation PCB

[2] Circuit Board Material: Rogers 4350

The circuit board used in the final application should use RF circuit design techniques. Signal lines should have 50 ohm impedance while the package ground leads and exposed paddle should be connected directly to the ground plane similar to that shown. A sufficient number of via holes should be used to connect the top and bottom ground planes. The evaluation circuit board shown is available from Hittite upon request.



**GaAs MMIC MIXER w/ INTEGRATED  
IF & LO AMPLIFIER, 1.8 - 3.9 GHz**

**Application Circuit - Upconverter Mode**

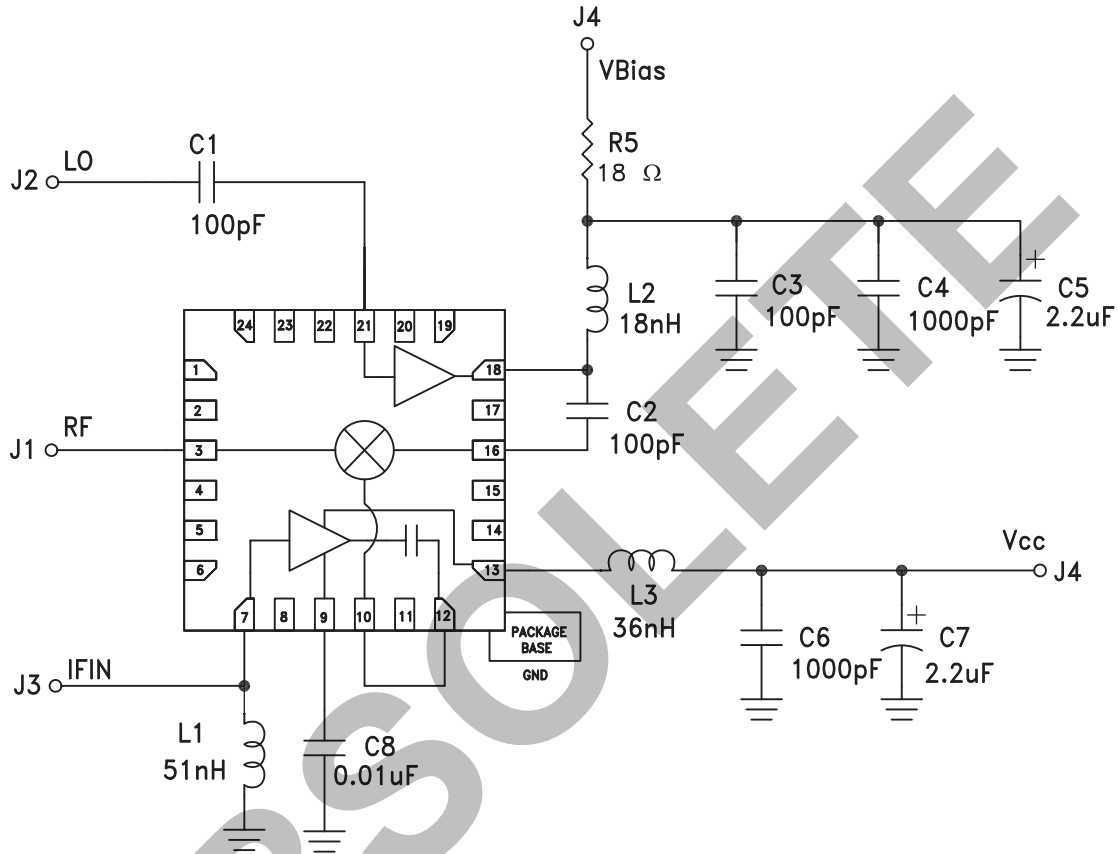

Recommended Components Values (IF = 200 - 550 MHz)	
C1, C2, C3	100 pF Capacitor
C4, C6	1000 pF Capacitor
C5, C7	2.2 $\mu$ F Capacitor, Tantalum
C8	0.01 $\mu$ F Capacitor
L1	51 nH Inductor
L2	18 nH Inductor
L3	36 nH Inductor
R5	18 Ohm (1/8 Watt)

Information furnished by Analog Devices is believed to be accurate and reliable. However, no responsibility is assumed by Analog Devices for its use, nor for any infringements of patents or other rights of third parties that may result from its use. Specifications subject to change without notice. No license is granted by implication or otherwise under any patent or patent rights of Analog Devices. Trademarks and registered trademarks are the property of their respective owners.

For price, delivery, and to place orders: Analog Devices, Inc., One Technology Way, P.O. Box 9106, Norwood, MA 02062-9106 Phone: 781-329-4700 • Order online at [www.analog.com](http://www.analog.com) Application Support: Phone: 1-800-ANALOG-D

**GaAs MMIC MIXER w/ INTEGRATED  
IF & LO AMPLIFIER, 1.8 - 3.9 GHz**



**Application Circuit - Downconverter Mode**

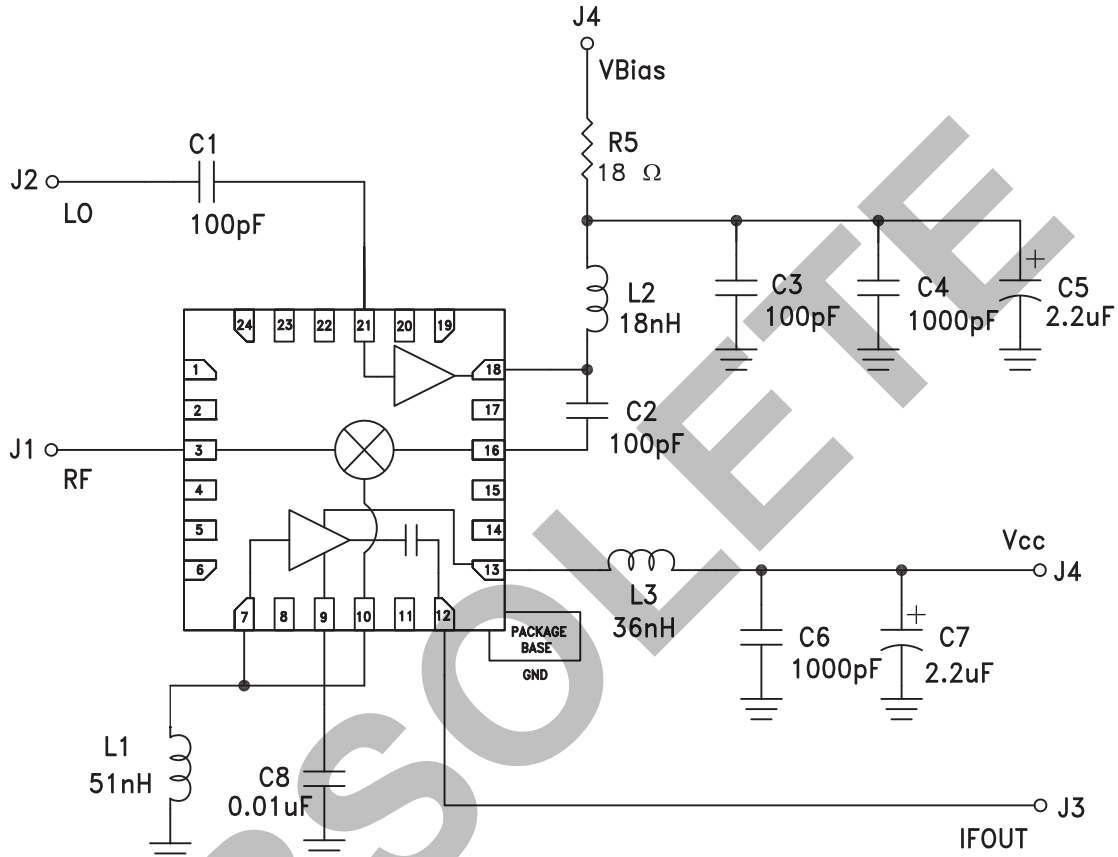

Recommended Components Values (IF = 200 - 550 MHz)	
C1, C2, C3	100 pF Capacitor
C4, C6	1000 pF Capacitor
C5, C7	2.2 μF Capacitor, Tantalum
C8	0.01 μF Capacitor
L1	51 nH Inductor
L2	18 nH Inductor
L3	36 nH Inductor
R5	18 Ohm (1/8 Watt)

Information furnished by Analog Devices is believed to be accurate and reliable. However, no responsibility is assumed by Analog Devices for its use, nor for any infringements of patents or other rights of third parties that may result from its use. Specifications subject to change without notice. No license is granted by implication or otherwise under any patent or patent rights of Analog Devices. Trademarks and registered trademarks are the property of their respective owners.

For price, delivery, and to place orders: Analog Devices, Inc., One Technology Way, P.O. Box 9106, Norwood, MA 02062-9106 Phone: 781-329-4700 • Order online at [www.analog.com](http://www.analog.com) Application Support: Phone: 1-800-ANALOG-D

## Looking for pricing, stock, or lifecycle information?

Click below to explore more details on WIN SOURCE:

 [View HMC622LP4E on WIN SOURCE](#)

 [Analog Devices Inc. Information](#)

## Optimize Your Supply Chain with WIN SOURCE Solutions

-  Global Sourcing Solution
-  Obsolete Management
-  Cost Control Management
-  Shortage Management
-  Alternative Solution
-  Excess Inventory Management