



**THE DATASHEET OF
TPS73225DCQR**



TPS732xx Capacitor-Free, NMOS, 250-mA Low-Dropout Regulator With Reverse Current Protection

1 Features

- Stable with No Output Capacitor or Any Value or Type of Capacitor
- Input Voltage Range: 1.7 V to 5.5 V
- Ultralow Dropout Voltage: 40 mV Typical at 250 mA
- Excellent Load Transient Response—With or Without Optional Output Capacitor
- NMOS Topology Provides Low Reverse Leakage Current
- Low Noise: 30 μV_{RMS} Typical (10 kHz to 100 kHz)
- 0.5% Initial Accuracy
- 1% Overall Accuracy (Line, Load, and Temperature)
- Less Than 1- μA Maximum I_{Q} in Shutdown Mode
- Thermal Shutdown and Specified Min and Max Current Limit Protection
- Available in Multiple Output Voltage Versions
 - Fixed Outputs of 1.2 V to 5 V
 - Adjustable Outputs from 1.2 V to 5.5 V
 - Custom Outputs Available

2 Applications

- Portable and Battery-Powered Equipment
- Post-Regulation for Switching Supplies
- Noise-Sensitive Circuitry such as VCOs
- Point-of-Load Regulation for DSPs, FPGAs, ASICs, and Microprocessors

3 Description

The TPS732 family of low-dropout (LDO) voltage regulators uses an NMOS pass element in a voltage-follower configuration. This topology is stable using output capacitors with low equivalent series resistance (ESR), and even allows operation without a capacitor. The device also provides high reverse blockage (low reverse current) and ground pin current that is nearly constant over all values of output current.

The TPS732 uses an advanced BiCMOS process to yield high precision while delivering very low dropout voltages and low ground pin current. Current consumption, when not enabled, is less than 1 μA and ideal for portable applications. The extremely low output noise (30 μV_{RMS} with 0.1- μF C_{NR}) is ideal for powering VCOs. These devices are protected by thermal shutdown and foldback current limit.

Device Information⁽¹⁾

PART NUMBER	PACKAGE	BODY SIZE (NOM)
TPS732xx	SOT-23 (5)	2.90 mm x 1.60 mm
	SOT-223 (6)	6.50 mm x 3.50 mm
	SON (8)	3.00 mm x 3.00 mm

(1) For all available packages, see the orderable addendum at the end of the data sheet.

Typical Application Circuit for Fixed-Voltage Versions

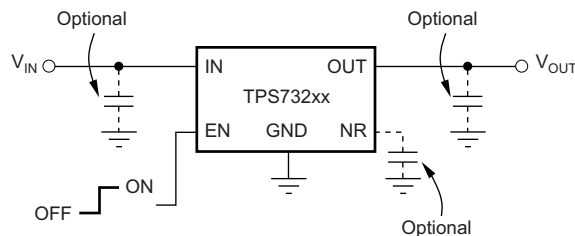

Table of Contents

1 Features 1 2 Applications 1 3 Description 1 4 Revision History 2 5 Pin Configuration and Functions 3 6 Specifications 4 6.1 Absolute Maximum Ratings 4 6.2 ESD Ratings 4 6.3 Recommended Operating Conditions 4 6.4 Thermal Information 5 6.5 Electrical Characteristics 6 6.6 Switching Characteristics 6 6.7 Typical Characteristics 7 7 Detailed Description 12 7.1 Overview 12 7.2 Functional Block Diagrams 12 7.3 Feature Description 13 7.4 Device Functional Modes 15	8 Application and Implementation 16 8.1 Application Information 16 8.2 Typical Applications 16 9 Power Supply Recommendations 19 10 Layout 19 10.1 Layout Guidelines 19 10.2 Layout Examples 19 10.3 Thermal Considerations 20 11 Device and Documentation Support 22 11.1 Device Support 22 11.2 Documentation Support 22 11.3 Related Links 22 11.4 Community Resources 23 11.5 Trademarks 23 11.6 Electrostatic Discharge Caution 23 11.7 Glossary 23 12 Mechanical, Packaging, and Orderable Information 23
---	--

4 Revision History

NOTE: Page numbers for previous revisions may differ from page numbers in the current version.

Changes from Revision O (August 2010) to Revision P	Page
• Changed <i>Features</i> bullet about NMOS topology; deleted "new" 1	1
• Added <i>ESD Ratings</i> table, <i>Feature Description</i> section, <i>Device Functional Modes</i> , <i>Application and Implementation</i> section, <i>Power Supply Recommendations</i> section, <i>Layout</i> section, <i>Device and Documentation Support</i> section, and <i>Mechanical, Packaging, and Orderable Information</i> section 1	1
• Changed first paragraph of <i>Description</i> section; deleted description of NMOS topology as "new" 1	1
• Changed Pin Configuration and Functions section; updated table format 3	3
• Changed "free-air temperature" to "junction temperature" in <i>Absolute Maximum Ratings</i> condition statement 4	4
• Changed <i>Thermal Information</i> table; updated thermal resistance values for all packages 5	5

Changes from Revision N (August, 2009) to Revision O	Page
• Replaced the <i>Dissipation Ratings</i> table with the <i>Thermal Information</i> table 6	6

Changes from Revision M (May, 2008) to Revision N	Page
• Changed Figure 10 7	7
• Added paragraph about recommended start-up sequence to <i>Internal Current Limit</i> section 14	14
• Added paragraph about current foldback and device start-up to <i>Enable Pin and Shutdown</i> section 14	14

5 Pin Configuration and Functions



DRB Package
8-Pin SON With Exposed Thermal Pad
Top View

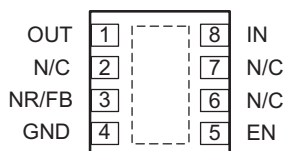

Pin Functions

NAME	PIN NO.			I/O	DESCRIPTION
	SOT-23	SOT-223	SON		
IN	1	1	8	I	Input supply
GND	2	3, 6	4, Pad	—	Ground
EN	3	5	5	I	Driving the enable pin (EN) high turns on the regulator. Driving this pin low puts the regulator into shutdown mode. Refer to the Shutdown section under Feature Description for more details. EN can be connected to IN if not used.
NR	4	4	3	—	Fixed voltage versions only—connecting an external capacitor to this pin bypasses noise generated by the internal bandgap, reducing output noise to very low levels.
FB	4	4	3	I	Adjustable voltage version only—this pin is the input to the control loop error amplifier, and is used to set the output voltage of the device.
OUT	5	2	1	O	Output of the regulator. There are no output capacitor requirements for stability.

6 Specifications

6.1 Absolute Maximum Ratings

over operating junction temperature range (unless otherwise noted) ⁽¹⁾

		MIN	MAX	UNIT
Voltage	V _{IN}	-0.3	6	V
	V _{EN}	-0.3	6	
	V _{OUT}	-0.3	5.5	
	V _{NR} , V _{FB}	-0.3	6	
Peak output current	I _{OUT}	Internally limited		
Output short-circuit duration		Indefinite		
Continuous total power dissipation		See Power Dissipation		
Temperature	Junction range, T _J	-55	150	°C
	Storage range, T _{stg}	-65	150	

- (1) Stresses beyond those listed under *Absolute Maximum Ratings* may cause permanent damage to the device. These are stress ratings only, which do not imply functional operation of the device at these or any other conditions beyond those indicated under *Recommended Operating Conditions*. Exposure to absolute-maximum-rated conditions for extended periods may affect device reliability.

6.2 ESD Ratings

		VALUE	UNIT
V _(ESD) Electrostatic discharge	Human body model (HBM), per ANSI/ESDA/JEDEC JS-001, all pins ⁽¹⁾	±2000	V
	Charged device model (CDM), per JEDEC specification JESD22-C101, all pins ⁽²⁾	±500	

- (1) JEDEC document JEP155 states that 500-V HBM allows safe manufacturing with a standard ESD control process.
 (2) JEDEC document JEP157 states that 250-V CDM allows safe manufacturing with a standard ESD control process.

6.3 Recommended Operating Conditions

over operating junction temperature range (unless otherwise noted).

		MIN	NOM	MAX	UNIT
V _{IN}	Input supply voltage range	1.7		5.5	V
I _{OUT}	Output current	0		250	mA
T _J	Operating junction temperature	-40		125	°C

6.4 Thermal Information

THERMAL METRIC ⁽¹⁾⁽²⁾		TPS732 ⁽³⁾			UNIT
		DRB [SON]	DCQ [SOT223]	DBV [SOT23]	
		8 PINS	6 PINS	5 PINS	
R _{θJA}	Junction-to-ambient thermal resistance	58.3	53.1	205.9	°C/W
R _{θJC(top)}	Junction-to-case (top) thermal resistance	93.8	35.2	119	
R _{θJB}	Junction-to-board thermal resistance	72.8	7.8	35.4	
Ψ _{JT}	Junction-to-top characterization parameter	2.7	2.9	12.7	
Ψ _{JB}	Junction-to-board characterization parameter	25	7.7	34.5	
R _{θJC(bot)}	Junction-to-case (bottom) thermal resistance	5	N/A	N/A	

- (1) For more information about traditional and new thermal metrics, see the *IC Package Thermal Metrics* application report, [SPRA953](#).
- (2) For thermal estimates of this device based on PCB copper area, see the [TI PCB Thermal Calculator](#).
- (3) Thermal data for the DRB, DCQ, and DRV packages are derived by thermal simulations based on JEDEC-standard methodology as specified in the JESD51 series. The following assumptions are used in the simulations:
- DRB: The exposed pad is connected to the PCB ground layer through a 2 × 2 thermal via array.
 - DCQ: The exposed pad is connected to the PCB ground layer through a 3 × 2 thermal via array.
 - DBV: There is no exposed pad with the DBV package.
- DRB: The top and bottom copper layers are assumed to have a 20% thermal conductivity of copper representing a 20% copper coverage.
 - DCQ: Each of top and bottom copper layers has a dedicated pattern for 20% copper coverage.
 - DBV: The top and bottom copper layers are assumed to have a 20% thermal conductivity of copper representing a 20% copper coverage.
- (c) These data were generated with only a single device at the center of a JEDEC high-K (2s2p) board with 3-inch × 3-inch copper area. To understand the effects of the copper area on thermal performance, see the [Power Dissipation](#) section of this data sheet.

6.5 Electrical Characteristics

Over operating temperature range ($T_J = -40^\circ\text{C}$ to 125°C), $V_{IN} = V_{OUT(nom)} + 0.5\text{ V}^{(1)}$, $I_{OUT} = 10\text{ mA}$, $V_{EN} = 1.7\text{ V}$, and $C_{OUT} = 0.1\text{ }\mu\text{F}$, unless otherwise noted. Typical values are at $T_J = 25^\circ\text{C}$.

PARAMETER		TEST CONDITIONS	MIN	TYP	MAX	UNIT
V_{IN}	Input voltage range ⁽¹⁾		1.7		5.5	V
V_{FB}	Internal reference (TPS73201)	$T_J = 25^\circ\text{C}$	1.198	1.2	1.21	V
V_{OUT}	Output voltage range (TPS73201) ⁽²⁾		V_{FB}		$5.5 - V_{DO}$	V
	Accuracy ⁽¹⁾⁽³⁾	Nominal	$T_J = 25^\circ\text{C}$		0.5%	
		V_{IN} , I_{OUT} , and T	$V_{OUT} + 0.5\text{ V} \leq V_{IN} \leq 5.5\text{ V}$; $10\text{ mA} \leq I_{OUT} \leq 250\text{ mA}$		-1%	$\pm 0.5\%$
$\Delta V_{OUT(\Delta V_{IN})}$	Line regulation ⁽¹⁾	$V_{OUT(nom)} + 0.5\text{ V} \leq V_{IN} \leq 5.5\text{ V}$		0.01		%/V
$\Delta V_{OUT(\Delta I_{OUT})}$	Load regulation	$1\text{ mA} \leq I_{OUT} \leq 250\text{ mA}$		0.002		%/mA
		$10\text{ mA} \leq I_{OUT} \leq 250\text{ mA}$		0.0005		%/mA
V_{DO}	Dropout voltage ⁽⁴⁾ ($V_{IN} = V_{OUT(nom)} - 0.1\text{ V}$)	$I_{OUT} = 250\text{ mA}$		40	150	mV
$Z_{O(do)}$	Output impedance in dropout	$1.7\text{ V} \leq V_{IN} \leq V_{OUT} + V_{DO}$		0.25		Ω
I_{CL}	Output current limit	$V_{OUT} = 0.9 \times V_{OUT(nom)}$	250	425	600	mA
I_{SC}	Short-circuit current	$V_{OUT} = 0\text{ V}$		300		mA
I_{REV}	Reverse leakage current ⁽⁵⁾ ($-I_{IN}$)	$V_{EN} \leq 0.5\text{ V}$, $0\text{ V} \leq V_{IN} \leq V_{OUT}$		0.1	10	μA
I_{GND}	GND pin current	$I_{OUT} = 10\text{ mA}$ (I_Q)		400	550	μA
		$I_{OUT} = 250\text{ mA}$		650	950	
I_{SHDN}	Shutdown current (I_{GND})	$V_{EN} \leq 0.5\text{ V}$, $V_{OUT} \leq V_{IN} \leq 5.5$, $-40^\circ\text{C} \leq T_J \leq 100^\circ\text{C}$		0.02	1	μA
I_{FB}	FB pin current (TPS73201)			0.1	0.3	μA
PSRR	Power-supply rejection ratio (ripple rejection)	$f = 100\text{ Hz}$, $I_{OUT} = 250\text{ mA}$		58		dB
		$f = 10\text{ kHz}$, $I_{OUT} = 250\text{ mA}$		37		
V_n	Output noise voltage BW = 10Hz – 100kHz	$C_{OUT} = 10\text{ }\mu\text{F}$, No C_{NR}		$27 \times V_{OUT}$		μV_{RMS}
		$C_{OUT} = 10\text{ }\mu\text{F}$, $C_{NR} = 0.01\text{ }\mu\text{F}$		$8.5 \times V_{OUT}$		
$V_{EN(high)}$	EN pin high (enabled)		1.7		V_{IN}	V
$V_{EN(low)}$	EN pin low (shutdown)		0		0.5	V
$I_{EN(high)}$	EN pin current (enabled)	$V_{EN} = 5.5\text{ V}$		0.02	0.1	μA
T_{SD}	Thermal shutdown temperature	Shutdown Temp increasing		160		$^\circ\text{C}$
		Reset Temp decreasing		140		
T_J	Operating junction temperature		-40		125	$^\circ\text{C}$

(1) Minimum $V_{IN} = V_{OUT} + V_{DO}$ or 1.7 V, whichever is greater.

(2) TPS73201 is tested at $V_{OUT} = 2.5\text{ V}$.

(3) Tolerance of external resistors not included in this specification.

(4) V_{DO} is not measured for fixed output versions with $V_{OUT(nom)} < 1.8\text{ V}$ because minimum $V_{IN} = 1.7\text{ V}$.

(5) Fixed-voltage versions only; refer to [Application Information](#) section for more information.

6.6 Switching Characteristics

over operating free-air temperature range (unless otherwise noted)

PARAMETER	TEST CONDITIONS	MIN	TYP	MAX	UNIT
t_{STR}	Start-up time		600		μs
	$V_{OUT} = 3\text{ V}$, $R_L = 30\text{ }\Omega$ $C_{OUT} = 1\text{ }\mu\text{F}$, $C_{NR} = 0.01\text{ }\mu\text{F}$				

6.7 Typical Characteristics

For all voltage versions at $T_J = 25^\circ\text{C}$, $V_{IN} = V_{OUT(nom)} + 0.5\text{ V}$, $I_{OUT} = 10\text{ mA}$, $V_{EN} = 1.7\text{ V}$, and $C_{OUT} = 0.1\text{ }\mu\text{F}$, unless otherwise noted.

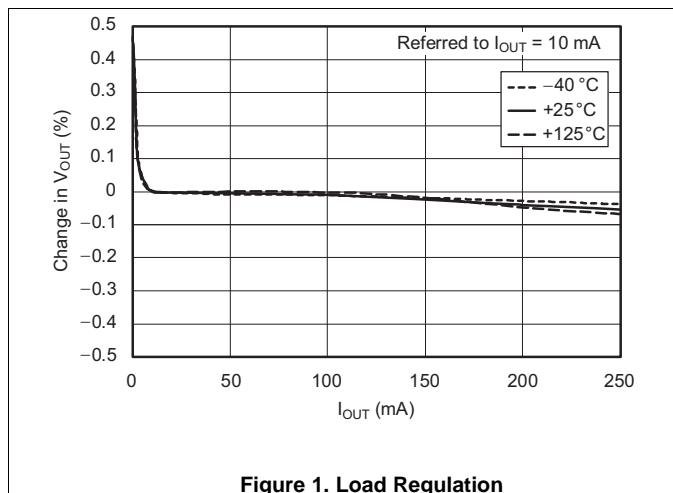

Figure 1. Load Regulation



Figure 2. Line Regulation

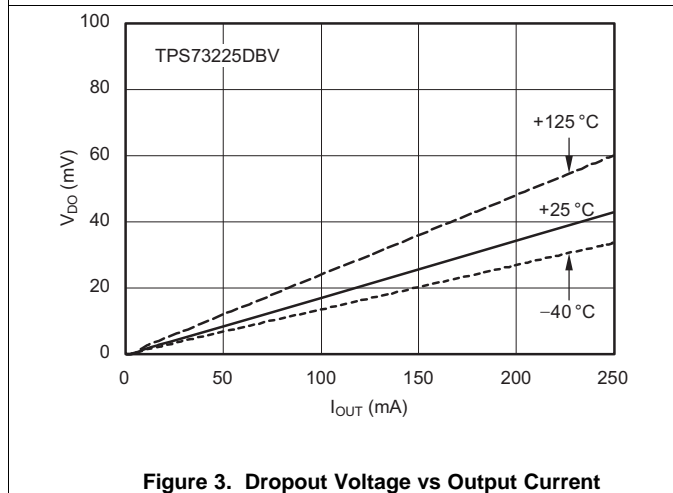

Figure 3. Dropout Voltage vs Output Current



Figure 4. Dropout Voltage vs Temperature

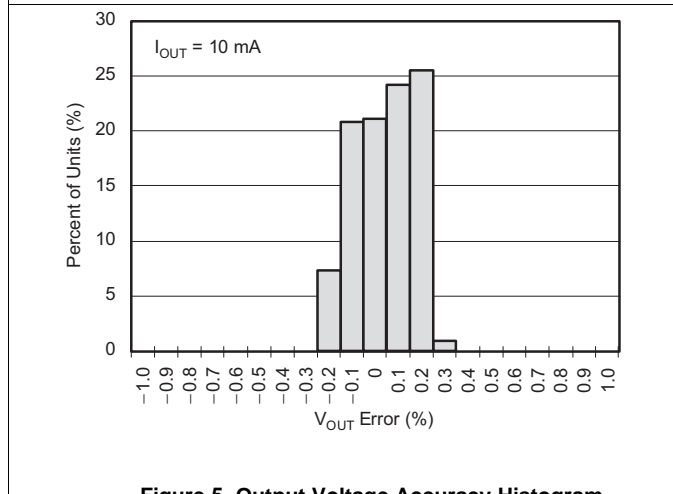

Figure 5. Output Voltage Accuracy Histogram



Figure 6. Output Voltage Drift Histogram

Typical Characteristics (continued)

For all voltage versions at $T_J = 25^\circ\text{C}$, $V_{IN} = V_{OUT(nom)} + 0.5\text{ V}$, $I_{OUT} = 10\text{ mA}$, $V_{EN} = 1.7\text{ V}$, and $C_{OUT} = 0.1\text{ }\mu\text{F}$, unless otherwise noted.



Figure 7. Ground Pin Current vs Output Current



Figure 8. Ground Pin Current vs Temperature



Figure 9. Ground Pin Current in Shutdown vs Temperature



Figure 10. Current Limit vs V_{OUT} (Foldback)



Figure 11. Current Limit vs V_{IN}



Figure 12. Current Limit vs Temperature

Typical Characteristics (continued)

For all voltage versions at $T_J = 25^\circ\text{C}$, $V_{IN} = V_{OUT(nom)} + 0.5\text{ V}$, $I_{OUT} = 10\text{ mA}$, $V_{EN} = 1.7\text{ V}$, and $C_{OUT} = 0.1\text{ }\mu\text{F}$, unless otherwise noted.



Figure 13. PSRR (Ripple Rejection) vs Frequency



Figure 14. PSRR (Ripple Rejection) vs $(V_{IN} - V_{OUT})$



Figure 15. Noise Spectral Density $C_{NR} = 0\text{ }\mu\text{F}$



Figure 16. Noise Spectral Density $C_{NR} = 0.01\text{ }\mu\text{F}$



Figure 17. RMS Noise Voltage vs C_{OUT}



Figure 18. RMS Noise Voltage vs C_{NR}

Typical Characteristics (continued)

For all voltage versions at $T_J = 25^\circ\text{C}$, $V_{IN} = V_{OUT(nom)} + 0.5\text{ V}$, $I_{OUT} = 10\text{ mA}$, $V_{EN} = 1.7\text{ V}$, and $C_{OUT} = 0.1\ \mu\text{F}$, unless otherwise noted.

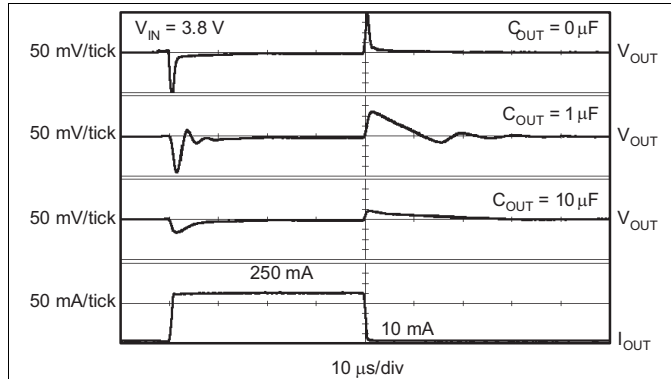

Figure 19. TPS73233 Load Transient Response

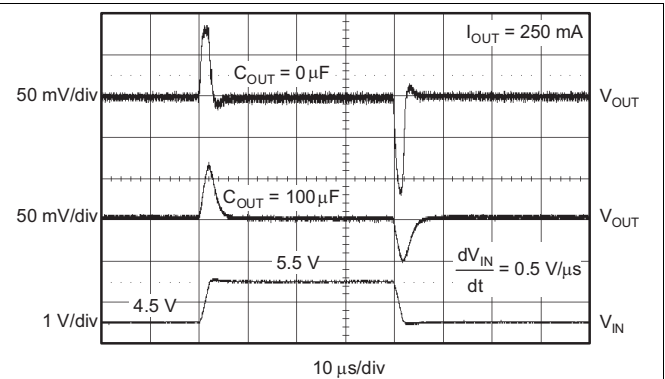

Figure 20. TPS73233 Line Transient Response

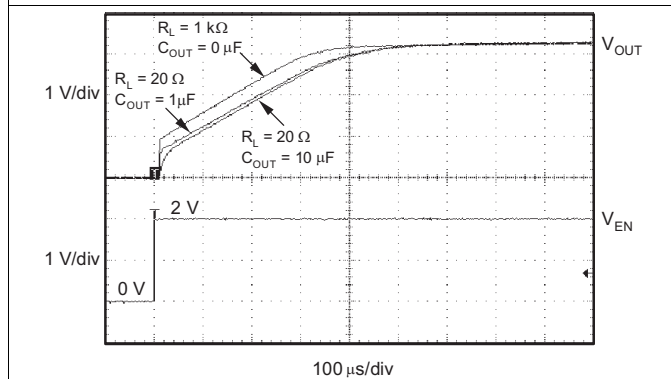

Figure 21. TPS73233 Turnon Response

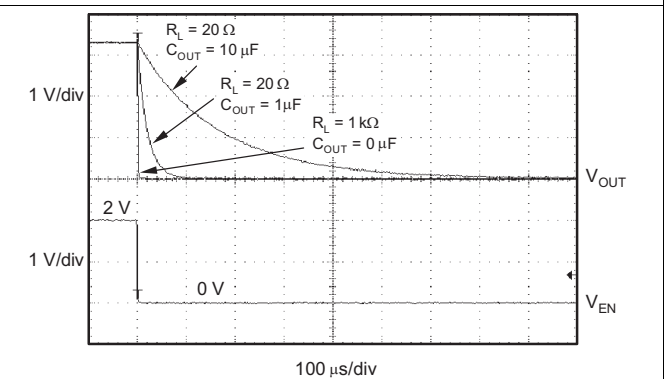

Figure 22. TPS73233 Turnoff Response

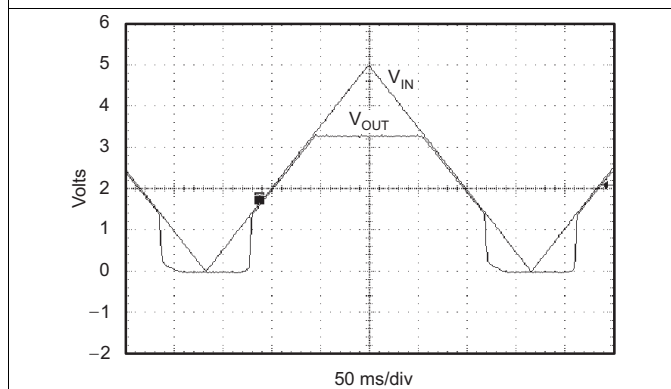

Figure 23. TPS73233 Power Up and Power Down

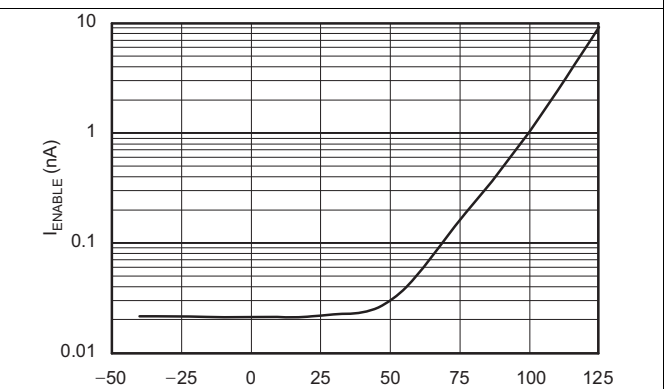

Figure 24. I_{ENABLE} vs Temperature

Typical Characteristics (continued)

For all voltage versions at $T_J = 25^\circ\text{C}$, $V_{IN} = V_{OUT(nom)} + 0.5\text{ V}$, $I_{OUT} = 10\text{ mA}$, $V_{EN} = 1.7\text{ V}$, and $C_{OUT} = 0.1\text{ }\mu\text{F}$, unless otherwise noted.

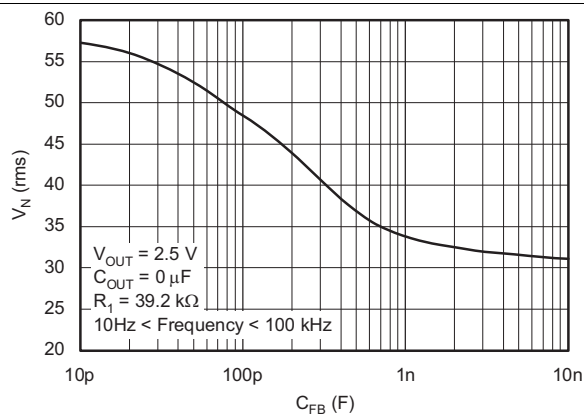

Figure 25. TPS73201 RMS Noise Voltage vs C_{FB}



Figure 26. TPS73201 I_{FB} vs Temperature



Figure 27. TPS73201 Load Transient, Adjustable Version



Figure 28. TPS73201 Line Transient, Adjustable Version

7 Detailed Description

7.1 Overview

The TPS732 family of low-dropout linear regulators operates down to an input voltage of 1.7 V and supports output voltages down to 1.2 V while sourcing up to 500 mA of load current. This linear regulator uses an NMOS pass element with an integrated 4-MHz charge pump to provide a dropout voltage of less than 250 mV at full load current. This unique architecture also permits stable regulation over a wide range of output capacitors. In fact, the TPS732 family of devices does not require any output capacitor for stability. The increased insensitivity to the output capacitor value and type makes this family of linear regulators an ideal choice when powering a load where the effective capacitance is unknown.

The TPS732 family of devices also features a noise reduction (NR) pin that allows for additional reduction of the output noise. With a noise reduction capacitor of 0.01 μF connected from the NR pin to GND, the TPS73215 output noise can be as low as 12.75 μV_{RMS} . The low noise output featured by the TPS732 family makes the device well-suited for powering VCOs or any other noise-sensitive load.

7.2 Functional Block Diagrams



Figure 29. Fixed-Voltage Version

Functional Block Diagrams (continued)



Table 1. Standard 1% Resistor Values for Common Output Voltages

V _O	R ₁	R ₂
1.2V	Short	Open
1.5V	23.2kΩ	95.3kΩ
1.8V	28.0kΩ	56.2kΩ
2.5V	39.2kΩ	36.5kΩ
2.8V	44.2kΩ	33.2kΩ
3.0V	46.4kΩ	30.9kΩ
3.3V	52.3kΩ	30.1kΩ

NOTE: $V_{OUT} = (R_1 + R_2)/R_2 \times 1.204$;
 $R_1 || R_2 \cong 19k\Omega$ for best accuracy.

Figure 30. Adjustable-Voltage Version

7.3 Feature Description

7.3.1 Output Noise

A precision band-gap reference is used to generate the internal reference voltage, V_{REF} . This reference is the dominant noise source within the TPS732 and it generates approximately $32 \mu V_{RMS}$ (10 Hz to 100 kHz) at the reference output (NR). The regulator control loop gains up the reference noise with the same gain as the reference voltage, so that the noise voltage of the regulator is approximately given by:

$$V_N = 32\mu V_{RMS} \times \left(\frac{R_1 + R_2}{R_2} \right) = 32\mu V_{RMS} \times \frac{V_{OUT}}{V_{REF}} \tag{1}$$

Because the value of V_{REF} is 1.2 V, this relationship reduces to:

$$V_N(\mu V_{RMS}) = 27 \left(\frac{\mu V_{RMS}}{V} \right) \times V_{OUT}(V) \tag{2}$$

An internal 27-kΩ resistor in series with the noise reduction pin (NR) forms a low-pass filter for the voltage reference when an external noise reduction capacitor, C_{NR} , is connected from NR to ground. For $C_{NR} = 10$ nF, the total noise in the 10-Hz to 100-kHz bandwidth is reduced by a factor of approximately 3.2, giving the approximate relationship:

$$V_N(\mu V_{RMS}) = 8.5 \left(\frac{\mu V_{RMS}}{V} \right) \times V_{OUT}(V) \tag{3}$$

for $C_{NR} = 10$ nF.

Feature Description (continued)

This noise reduction effect is shown as *RMS Noise Voltage vs C_{NR}* (Figure 18) in the *Typical Characteristics* section.

The TPS73201 adjustable version does not have the NR pin available. However, connecting a feedback capacitor, C_{FB} , from the output to the feedback pin (FB) reduces output noise and improve load transient performance.

The TPS732 uses an internal charge pump to develop an internal supply voltage sufficient to drive the gate of the NMOS pass element above V_{OUT} . The charge pump generates approximately 250 μ V of switching noise at approximately 4 MHz; however, charge-pump noise contribution is negligible at the output of the regulator for most values of I_{OUT} and C_{OUT} .

7.3.2 Internal Current Limit

The TPS732 internal current limit helps protect the regulator during fault conditions. Foldback current limit helps to protect the regulator from damage during output short-circuit conditions by reducing current limit when V_{OUT} drops below 0.5 V. See Figure 10 in the *Typical Characteristics* section for a graph of I_{OUT} vs V_{OUT} .

Note from Figure 10 that approximately -0.2 V of V_{OUT} results in a current limit of 0 mA. Therefore, if OUT is forced below -0.2 V before EN goes high, the device may not start up. In applications that work with both a positive and negative voltage supply, the TPS732 should be enabled first.

7.3.3 Enable Pin and Shutdown

The enable pin (EN) is active high and is compatible with standard TTL-CMOS levels. A V_{EN} below 0.5 V (maximum) turns the regulator off and drops the GND pin current to approximately 10 nA. When EN is used to shut down the regulator, all charge is removed from the pass transistor gate, and the output ramps back up to a regulated V_{OUT} (see Figure 21).

When shutdown capability is not required, EN can be connected to V_{IN} . However, the pass gate may not be discharged using this configuration, and the pass transistor may be left on (enhanced) for a significant time after V_{IN} has been removed. This scenario can result in reverse current flow (if the IN pin is low impedance) and faster ramp times upon power up. In addition, for V_{IN} ramp times slower than a few milliseconds, the output may overshoot upon power up.

Note that current limit foldback can prevent device start-up under some conditions. See the *Internal Current Limit* section.

7.3.4 Dropout Voltage

The TPS732 uses an NMOS pass transistor to achieve extremely low dropout. When $(V_{IN} - V_{OUT})$ is less than the dropout voltage (V_{DO}), the NMOS pass device is in its linear region of operation and the input-to-output resistance is the $R_{DS(on)}$ of the NMOS pass element.

For large step changes in load current, the TPS732 requires a larger voltage drop from V_{IN} to V_{OUT} to avoid degraded transient response. The boundary of this transient dropout region is approximately twice the DC dropout. Values of $(V_{IN} - V_{OUT})$ above this line ensure normal transient response.

Operating in the transient dropout region can cause an increase in recovery time. The time required to recover from a load transient is a function of the magnitude of the change in load current rate, the rate of change in load current, and the available headroom (V_{IN} to V_{OUT} voltage drop). Under worst-case conditions [full-scale instantaneous load change with $(V_{IN} - V_{OUT})$ close to DC dropout levels], the TPS732 can take a couple of hundred microseconds to return to the specified regulation accuracy.

Feature Description (continued)

7.3.5 Reverse Current

The NMOS pass element of the TPS732 provides inherent protection against current flow from the output of the regulator to the input when the gate of the pass device is pulled low. To ensure that all charge is removed from the gate of the pass element, the EN pin must be driven low before the input voltage is removed. If this is not done, the pass element may be left on due to stored charge on the gate.

After the EN pin is driven low, no bias voltage is needed on any pin for reverse current blocking. Reverse current is specified as the current flowing out of the IN pin due to voltage applied on the OUT pin. Additional current will flow into the OUT pin due to the 80-k Ω internal resistor divider to ground (see [Figure 29](#) and [Figure 30](#)).

For the TPS73201, reverse current may flow when V_{FB} is more than 1 V above V_{IN} .

7.4 Device Functional Modes

7.4.1 Normal Operation With $1.7\text{ V} \leq V_{IN} \leq 5.5\text{ V}$ and $V_{EN} \geq 1.7\text{ V}$

The TPS732 family requires an input voltage of at least 1.7 V to function properly and attempt to maintain regulation.

When operating the device near 5.5 V, take care to suppress any transient spikes that may exceed the 6-V absolute maximum voltage rating. The device should never operate at a DC voltage greater than 5.5 V.

8 Application and Implementation

NOTE

Information in the following applications sections is not part of the TI component specification, and TI does not warrant its accuracy or completeness. TI's customers are responsible for determining suitability of components for their purposes. Customers should validate and test their design implementation to confirm system functionality.

8.1 Application Information

The TPS732 device belongs to a family of LDO regulators that use an NMOS pass transistor to achieve ultra-low-dropout performance, reverse current blockage, and freedom from output capacitor constraints. These features, combined with low noise and an enable input, make the TPS732 ideal for portable applications. This regulator family offers a wide selection of fixed-output voltage versions and an adjustable-output version. All versions have thermal and overcurrent protection, including foldback current limit.

8.2 Typical Applications

Figure 31 shows the basic circuit connections for the fixed-voltage models. Figure 32 gives the connections for the adjustable-voltage version (TPS73201).

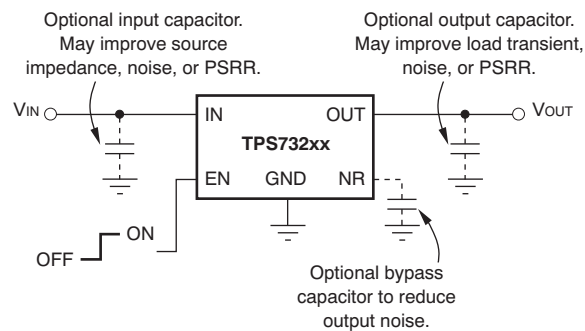

Figure 31. Typical Application Circuit for Fixed-Voltage Versions

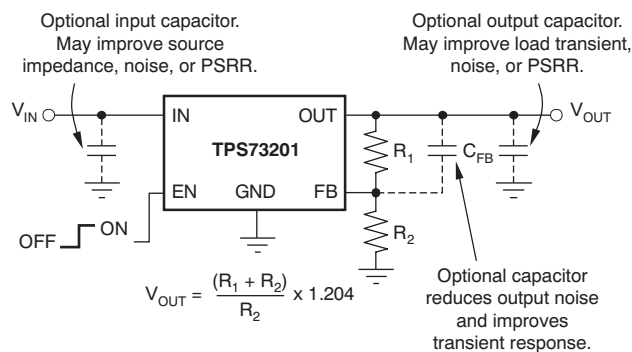

Figure 32. Typical Application Circuit for Adjustable-Voltage Version

Typical Applications (continued)

8.2.1 Design Requirements

For best accuracy, make the parallel combination of R_1 and R_2 approximately equal to 19 k Ω . This 19 k Ω , in addition to the internal 8-k Ω resistor, presents the same impedance to the error amp as the 27-k Ω bandgap reference output. This impedance helps compensate for leakages into the error amp terminals.

8.2.2 Detailed Design Procedure

8.2.2.1 Input and Output Capacitor Requirements

Although an input capacitor is not required for stability, it is good analog design practice to connect a 0.1- μ F to 1- μ F, low ESR capacitor across the input supply near the regulator. This capacitor counteracts reactive input sources and improves transient response, noise rejection, and ripple rejection. A higher-value capacitor may be necessary if large, fast rise-time load transients are anticipated or the device is located several inches from the power source.

The TPS732 does not require an output capacitor for stability and has maximum phase margin with no capacitor. It is designed to be stable for all available types and values of capacitors. In applications where multiple low ESR capacitors are in parallel, ringing may occur when the product of C_{OUT} and total ESR drops below 50 n Ω F. Total ESR includes all parasitic resistances, including capacitor ESR and board, socket, and solder joint resistance. In most applications, the sum of capacitor ESR and trace resistance meets this requirement.

8.2.2.2 Transient Response

The low open-loop output impedance provided by the NMOS pass element in a voltage follower configuration allows operation without an output capacitor for many applications. As with any regulator, the addition of a capacitor (nominal value 1 μ F) from the OUT pin to ground reduces undershoot magnitude but increases its duration. In the adjustable version, the addition of a capacitor, C_{FB} , from the OUT pin to the FB pin also improves the transient response.

The TPS732 does not have active pulldown when the output is overvoltage. This feature allows applications that connect higher voltage sources, such as alternate power supplies, to the output. This feature also results in an output overshoot of several percent if the load current quickly drops to zero when a capacitor is connected to the output. The duration of overshoot can be reduced by adding a load resistor. The overshoot decays at a rate determined by output capacitor C_{OUT} and the internal/external load resistance. The rate of decay is given by:

(Fixed voltage versions)

$$dV / dt = \frac{V_{OUT}}{C_{OUT} \times 80k\Omega \parallel R_{LOAD}} \quad (4)$$

(Adjustable voltage version)

$$dV / dt = \frac{V_{OUT}}{C_{OUT} \times 80k\Omega \parallel (R_1 + R_2) \parallel R_{LOAD}} \quad (5)$$

Typical Applications (continued)

8.2.3 Application Curves

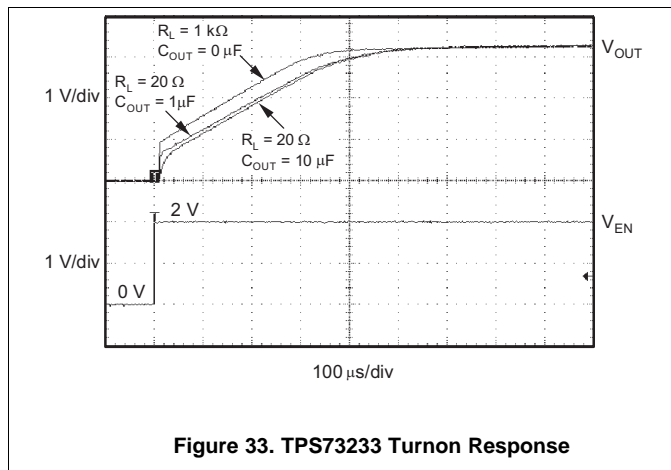

Figure 33. TPS73233 Turnon Response

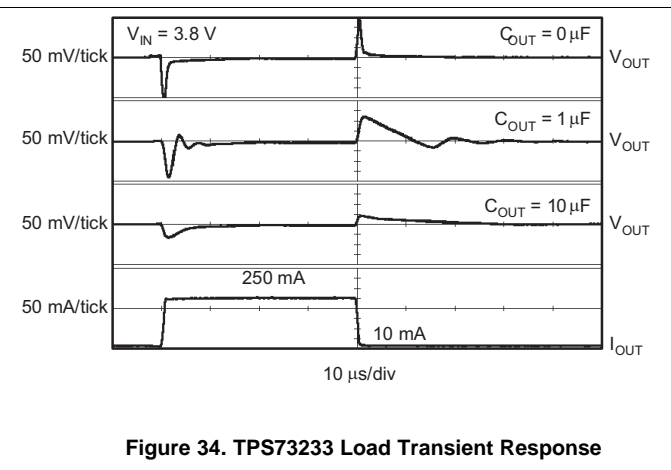

Figure 34. TPS73233 Load Transient Response

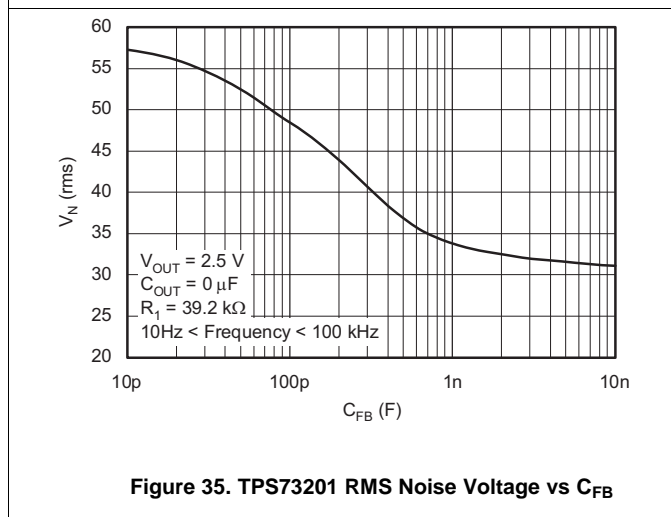

Figure 35. TPS73201 RMS Noise Voltage vs C_{FB}

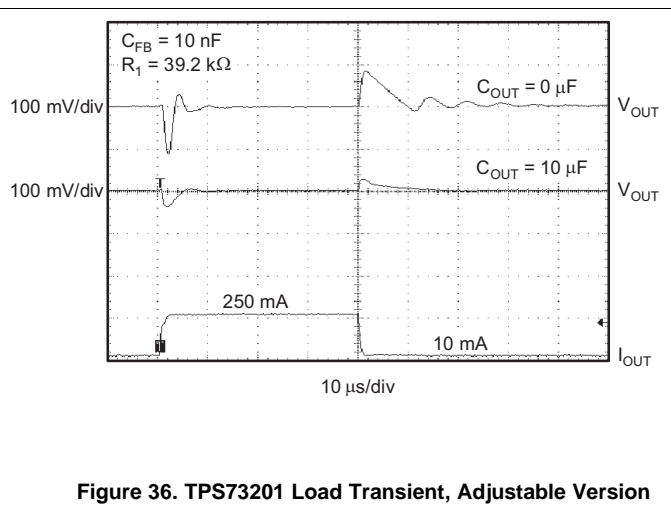

Figure 36. TPS73201 Load Transient, Adjustable Version

9 Power Supply Recommendations

These devices are designed to operate from an input voltage supply range between 1.7 V and 5.5 V. The input voltage range provides adequate headroom in order for the device to have a regulated output. This input supply must be well regulated. If the input supply is noisy, additional input capacitors with low ESR can help improve the output noise performance.

10 Layout

10.1 Layout Guidelines

To improve AC performance such as PSRR, output noise, and transient response, TI recommends designing the PCB with separate ground planes for V_{IN} and V_{OUT} , with each ground plane connected only at the GND pin of the device. In addition, the ground connection for the bypass capacitor should connect directly to the GND pin of the device.

Solder pad footprint recommendations for the TPS732 are presented in Application Bulletin *Solder Pad Recommendations for Surface-Mount Devices* (SBFA015), available from the TI website at www.ti.com.

10.2 Layout Examples



Figure 37. Fixed Output Voltage Option Layout (DRB Package)

Layout Examples (continued)



Figure 38. Adjustable Output Voltage Option Layout (DRB Package)

10.3 Thermal Considerations

Thermal protection disables the output when the junction temperature rises to approximately 160°C, allowing the device to cool. When the junction temperature cools to approximately 140°C, the output circuitry is again enabled. Depending on power dissipation, thermal resistance, and ambient temperature, the thermal protection circuit may cycle on and off. This limits the dissipation of the regulator, protecting it from damage due to overheating.

Any tendency to activate the thermal protection circuit indicates excessive power dissipation or an inadequate heatsink. For reliable operation, junction temperature should be limited to 125°C maximum. To estimate the margin of safety in a complete design (including heatsink), increase the ambient temperature until the thermal protection is triggered; use worst-case loads and signal conditions. For good reliability, thermal protection should trigger at least 35°C above the maximum expected ambient condition of your application. This produces a worst-case junction temperature of 125°C at the highest expected ambient temperature and worst-case load.

The internal protection circuitry of the TPS732 has been designed to protect against overload conditions. It was not intended to replace proper heatsinking. Continuously running the TPS732 into thermal shutdown will degrade device reliability.

Thermal Considerations (continued)

10.3.1 Power Dissipation

The ability to remove heat from the die is different for each package type, presenting different considerations in the PCB layout. The PCB area around the device that is free of other components moves the heat from the device to the ambient air. Performance data for JEDEC low- and high-K boards are shown in the [Thermal Information](#) table. Using heavier copper increases the effectiveness in removing heat from the device. The addition of plated through-holes to heat-dissipating layers also improves the heat-sink effectiveness.

Power dissipation depends on input voltage and load conditions. Power dissipation (P_D) is equal to the product of the output current times the voltage drop across the output pass element (V_{IN} to V_{OUT}):

$$P_D = (V_{IN} - V_{OUT}) \times I_{OUT} \quad (6)$$

Power dissipation can be minimized by using the lowest possible input voltage necessary to assure the required output voltage.

11 Device and Documentation Support

11.1 Device Support

11.1.1 Development Support

11.1.1.1 Evaluation Modules

An evaluation module (EVM) is available to assist in the initial circuit performance evaluation using the TPS732. The [TPS73201DRBEVM-518 evaluation module](#) (and [related user guide](#)) can be requested at the Texas Instruments website through the product folders or purchased directly from the [TI eStore](#).

11.1.1.2 Spice Models

Computer simulation of circuit performance using SPICE is often useful when analyzing the performance of analog circuits and systems. A SPICE model for the TPS732 is available through the product folders under *Simulation Models*.

11.1.2 Device Nomenclature

Table 1. Device Nomenclature⁽¹⁾

PRODUCT	V _{OUT}
TPS732xx yyy z	XX is the nominal output voltage (for example, 25 = 2.5 V; 01 = Adjustable). YYY is the package designator. Z is the tape and reel quantity (R = 3000, T = 250).

(1) For the most current package and ordering information see the Package Option Addendum at the end of this document, or see the TI website at www.ti.com.

11.2 Documentation Support

11.2.1 Related Documentation

- *Regulating V_{OUT} Below 1.2 V Using an External Reference*, [SLVA216](#)
- *Solder Pad Recommendations for Surface-Mount Devices*, [SBFA019](#)
- *TPS73x01DRBEVM-518 User's Guide*, [SBVU014](#)

11.3 Related Links

The table below lists quick access links. Categories include technical documents, support and community resources, tools and software, and quick access to sample or buy.

Table 2. Related Links

PARTS	PRODUCT FOLDER	SAMPLE & BUY	TECHNICAL DOCUMENTS	TOOLS & SOFTWARE	SUPPORT & COMMUNITY
TPS73201	Click here	Click here	Click here	Click here	Click here
TPS73213	Click here	Click here	Click here	Click here	Click here
TPS73215	Click here	Click here	Click here	Click here	Click here
TPS73216	Click here	Click here	Click here	Click here	Click here
TPS73218	Click here	Click here	Click here	Click here	Click here
TPS73219	Click here	Click here	Click here	Click here	Click here
TPS73225	Click here	Click here	Click here	Click here	Click here
TPS73230	Click here	Click here	Click here	Click here	Click here
TPS73233	Click here	Click here	Click here	Click here	Click here
TPS73250	Click here	Click here	Click here	Click here	Click here

11.4 Community Resources

The following links connect to TI community resources. Linked contents are provided "AS IS" by the respective contributors. They do not constitute TI specifications and do not necessarily reflect TI's views; see TI's [Terms of Use](#).

TI E2E™ Online Community *TI's Engineer-to-Engineer (E2E) Community*. Created to foster collaboration among engineers. At e2e.ti.com, you can ask questions, share knowledge, explore ideas and help solve problems with fellow engineers.

Design Support *TI's Design Support* Quickly find helpful E2E forums along with design support tools and contact information for technical support.

11.5 Trademarks

E2E is a trademark of Texas Instruments.
All other trademarks are the property of their respective owners.

11.6 Electrostatic Discharge Caution



These devices have limited built-in ESD protection. The leads should be shorted together or the device placed in conductive foam during storage or handling to prevent electrostatic damage to the MOS gates.

11.7 Glossary

[SLYZ022](#) — *TI Glossary*.

This glossary lists and explains terms, acronyms, and definitions.

12 Mechanical, Packaging, and Orderable Information

The following pages include mechanical, packaging, and orderable information. This information is the most current data available for the designated devices. This data is subject to change without notice and revision of this document. For browser-based versions of this data sheet, refer to the left-hand navigation.

PACKAGING INFORMATION

Orderable Device	Status (1)	Package Type	Package Drawing	Pins	Package Qty	Eco Plan (2)	Lead/Ball Finish (6)	MSL Peak Temp (3)	Op Temp (°C)	Device Marking (4/5)	Samples
TPS73201DBVR	ACTIVE	SOT-23	DBV	5	3000	Green (RoHS & no Sb/Br)	CU NIPDAU	Level-1-260C-UNLIM	-40 to 125	PJEQ	Samples
TPS73201DBVRG4	ACTIVE	SOT-23	DBV	5	3000	Green (RoHS & no Sb/Br)	CU NIPDAU	Level-1-260C-UNLIM	-40 to 125	PJEQ	Samples
TPS73201DBVT	ACTIVE	SOT-23	DBV	5	250	Green (RoHS & no Sb/Br)	CU NIPDAU	Level-1-260C-UNLIM	-40 to 125	PJEQ	Samples
TPS73201DBVTG4	ACTIVE	SOT-23	DBV	5	250	Green (RoHS & no Sb/Br)	CU NIPDAU	Level-1-260C-UNLIM	-40 to 125	PJEQ	Samples
TPS73201DCQ	ACTIVE	SOT-223	DCQ	6	78	Green (RoHS & no Sb/Br)	CU NIPDAU	Level-2-260C-1 YEAR	-40 to 125	PS73201	Samples
TPS73201DCQR	ACTIVE	SOT-223	DCQ	6	2500	Green (RoHS & no Sb/Br)	CU SN	Level-2-260C-1 YEAR	-40 to 125	PS73201	Samples
TPS73201DRBR	ACTIVE	SON	DRB	8	3000	Green (RoHS & no Sb/Br)	CU NIPDAU	Level-2-260C-1 YEAR	-40 to 125	PJEQ	Samples
TPS73201DRBRG4	ACTIVE	SON	DRB	8	3000	Green (RoHS & no Sb/Br)	CU NIPDAU	Level-2-260C-1 YEAR	-40 to 125	PJEQ	Samples
TPS73201DRBT	ACTIVE	SON	DRB	8	250	Green (RoHS & no Sb/Br)	CU NIPDAU	Level-2-260C-1 YEAR	-40 to 125	PJEQ	Samples
TPS73201DRBTG4	ACTIVE	SON	DRB	8	250	Green (RoHS & no Sb/Br)	CU NIPDAU	Level-2-260C-1 YEAR	-40 to 125	PJEQ	Samples
TPS73213DBVR	ACTIVE	SOT-23	DBV	5	3000	Green (RoHS & no Sb/Br)	CU NIPDAU	Level-1-260C-UNLIM	-40 to 125	BWD	Samples
TPS73213DBVT	ACTIVE	SOT-23	DBV	5	250	Green (RoHS & no Sb/Br)	CU NIPDAU	Level-1-260C-UNLIM	-40 to 125	BWD	Samples
TPS73215DBVR	ACTIVE	SOT-23	DBV	5	3000	Green (RoHS & no Sb/Br)	CU NIPDAU	Level-1-260C-UNLIM	-40 to 125	T38	Samples
TPS73215DBVT	ACTIVE	SOT-23	DBV	5	250	Green (RoHS & no Sb/Br)	CU NIPDAU	Level-1-260C-UNLIM	-40 to 125	T38	Samples
TPS73215DCQ	ACTIVE	SOT-223	DCQ	6	78	Green (RoHS & no Sb/Br)	CU NIPDAU	Level-2-260C-1 YEAR	-40 to 125	PS73215	Samples
TPS73215DCQR	ACTIVE	SOT-223	DCQ	6	2500	Green (RoHS & no Sb/Br)	CU NIPDAU	Level-2-260C-1 YEAR	-40 to 125	PS73215	Samples
TPS73216DBVT	ACTIVE	SOT-23	DBV	5	250	Green (RoHS & no Sb/Br)	CU NIPDAU	Level-2-260C-1 YEAR	-40 to 125	T50	Samples

Orderable Device	Status (1)	Package Type	Package Drawing	Pins	Package Qty	Eco Plan (2)	Lead/Ball Finish (6)	MSL Peak Temp (3)	Op Temp (°C)	Device Marking (4/5)	Samples
TPS73216DBVTG4	ACTIVE	SOT-23	DBV	5	250	Green (RoHS & no Sb/Br)	CU NIPDAU	Level-2-260C-1 YEAR	-40 to 125	T50	Samples
TPS73218DBVR	ACTIVE	SOT-23	DBV	5	3000	Green (RoHS & no Sb/Br)	CU NIPDAU	Level-1-260C-UNLIM	-40 to 125	T37	Samples
TPS73218DBVRG4	ACTIVE	SOT-23	DBV	5	3000	Green (RoHS & no Sb/Br)	CU NIPDAU	Level-1-260C-UNLIM	-40 to 125	T37	Samples
TPS73218DBVT	ACTIVE	SOT-23	DBV	5	250	Green (RoHS & no Sb/Br)	CU NIPDAU	Level-1-260C-UNLIM	-40 to 125	T37	Samples
TPS73218DCQ	ACTIVE	SOT-223	DCQ	6	78	Green (RoHS & no Sb/Br)	CU NIPDAU	Level-2-260C-1 YEAR	-40 to 125	PS73218	Samples
TPS73218DCQR	ACTIVE	SOT-223	DCQ	6	2500	Green (RoHS & no Sb/Br)	CU SN	Level-2-260C-1 YEAR	-40 to 125	PS73218	Samples
TPS73219DBVR	ACTIVE	SOT-23	DBV	5	3000	Green (RoHS & no Sb/Br)	CU NIPDAU	Level-1-260C-UNLIM	-40 to 125	CGE	Samples
TPS73219DBVT	ACTIVE	SOT-23	DBV	5	250	Green (RoHS & no Sb/Br)	CU NIPDAU	Level-1-260C-UNLIM	-40 to 125	CGE	Samples
TPS73225DBVR	ACTIVE	SOT-23	DBV	5	3000	Green (RoHS & no Sb/Br)	CU NIPDAU	Level-1-260C-UNLIM	-40 to 125	T36	Samples
TPS73225DBVT	ACTIVE	SOT-23	DBV	5	250	Green (RoHS & no Sb/Br)	CU NIPDAU	Level-1-260C-UNLIM	-40 to 125	T36	Samples
TPS73225DBVTG4	ACTIVE	SOT-23	DBV	5	250	Green (RoHS & no Sb/Br)	CU NIPDAU	Level-1-260C-UNLIM	-40 to 125	T36	Samples
TPS73225DCQ	ACTIVE	SOT-223	DCQ	6	78	Green (RoHS & no Sb/Br)	CU NIPDAU	Level-2-260C-1 YEAR	-40 to 125	PS73225	Samples
TPS73225DCQR	ACTIVE	SOT-223	DCQ	6	2500	Green (RoHS & no Sb/Br)	CU NIPDAU	Level-2-260C-1 YEAR	-40 to 125	PS73225	Samples
TPS73230DBVR	ACTIVE	SOT-23	DBV	5	3000	Green (RoHS & no Sb/Br)	CU NIPDAU	Level-1-260C-UNLIM	-40 to 125	T39	Samples
TPS73230DBVT	ACTIVE	SOT-23	DBV	5	250	Green (RoHS & no Sb/Br)	CU NIPDAU	Level-1-260C-UNLIM	-40 to 125	T39	Samples
TPS73230DCQR	ACTIVE	SOT-223	DCQ	6	2500	Green (RoHS & no Sb/Br)	CU NIPDAU	Level-2-260C-1 YEAR	-40 to 125	PS73230	Samples
TPS73233DBVR	ACTIVE	SOT-23	DBV	5	3000	Green (RoHS & no Sb/Br)	CU NIPDAU	Level-1-260C-UNLIM	-40 to 125	T40	Samples
TPS73233DBVT	ACTIVE	SOT-23	DBV	5	250	Green (RoHS & no Sb/Br)	CU NIPDAU	Level-1-260C-UNLIM	-40 to 125	T40	Samples

Orderable Device	Status (1)	Package Type	Package Drawing	Pins	Package Qty	Eco Plan (2)	Lead/Ball Finish (6)	MSL Peak Temp (3)	Op Temp (°C)	Device Marking (4/5)	Samples
TPS73233DCQ	ACTIVE	SOT-223	DCQ	6	78	Green (RoHS & no Sb/Br)	CU NIPDAU	Level-2-260C-1 YEAR	-40 to 125	PS73233	Samples
TPS73233DCQR	ACTIVE	SOT-223	DCQ	6	2500	Green (RoHS & no Sb/Br)	CU SN	Level-2-260C-1 YEAR	-40 to 125	PS73233	Samples
TPS73250DBVR	ACTIVE	SOT-23	DBV	5	3000	Green (RoHS & no Sb/Br)	CU NIPDAU	Level-1-260C-UNLIM	-40 to 125	T41	Samples
TPS73250DBVT	ACTIVE	SOT-23	DBV	5	250	Green (RoHS & no Sb/Br)	CU NIPDAU	Level-1-260C-UNLIM	-40 to 125	T41	Samples
TPS73250DCQ	ACTIVE	SOT-223	DCQ	6	78	Green (RoHS & no Sb/Br)	CU NIPDAU	Level-2-260C-1 YEAR	-40 to 125	PS73250	Samples
TPS73250DCQR	ACTIVE	SOT-223	DCQ	6	2500	Green (RoHS & no Sb/Br)	CU NIPDAU	Level-2-260C-1 YEAR	-40 to 125	PS73250	Samples

(1) The marketing status values are defined as follows:

ACTIVE: Product device recommended for new designs.

LIFEBUY: TI has announced that the device will be discontinued, and a lifetime-buy period is in effect.

NRND: Not recommended for new designs. Device is in production to support existing customers, but TI does not recommend using this part in a new design.

PREVIEW: Device has been announced but is not in production. Samples may or may not be available.

OBSOLETE: TI has discontinued the production of the device.

(2) **RoHS:** TI defines "RoHS" to mean semiconductor products that are compliant with the current EU RoHS requirements for all 10 RoHS substances, including the requirement that RoHS substance do not exceed 0.1% by weight in homogeneous materials. Where designed to be soldered at high temperatures, "RoHS" products are suitable for use in specified lead-free processes. TI may reference these types of products as "Pb-Free".

RoHS Exempt: TI defines "RoHS Exempt" to mean products that contain lead but are compliant with EU RoHS pursuant to a specific EU RoHS exemption.

Green: TI defines "Green" to mean the content of Chlorine (Cl) and Bromine (Br) based flame retardants meet JS709B low halogen requirements of <=1000ppm threshold. Antimony trioxide based flame retardants must also meet the <=1000ppm threshold requirement.

(3) MSL, Peak Temp. - The Moisture Sensitivity Level rating according to the JEDEC industry standard classifications, and peak solder temperature.

(4) There may be additional marking, which relates to the logo, the lot trace code information, or the environmental category on the device.

(5) Multiple Device Markings will be inside parentheses. Only one Device Marking contained in parentheses and separated by a "~" will appear on a device. If a line is indented then it is a continuation of the previous line and the two combined represent the entire Device Marking for that device.

(6) Lead/Ball Finish - Orderable Devices may have multiple material finish options. Finish options are separated by a vertical ruled line. Lead/Ball Finish values may wrap to two lines if the finish value exceeds the maximum column width.

Important Information and Disclaimer: The information provided on this page represents TI's knowledge and belief as of the date that it is provided. TI bases its knowledge and belief on information provided by third parties, and makes no representation or warranty as to the accuracy of such information. Efforts are underway to better integrate information from third parties. TI has taken and continues to take reasonable steps to provide representative and accurate information but may not have conducted destructive testing or chemical analysis on incoming materials and chemicals. TI and TI suppliers consider certain information to be proprietary, and thus CAS numbers and other limited information may not be available for release.

In no event shall TI's liability arising out of such information exceed the total purchase price of the TI part(s) at issue in this document sold by TI to Customer on an annual basis.

OTHER QUALIFIED VERSIONS OF TPS732 :

- Automotive: [TPS732-Q1](#)

NOTE: Qualified Version Definitions:

- Automotive - Q100 devices qualified for high-reliability automotive applications targeting zero defects

TAPE AND REEL INFORMATION

QUADRANT ASSIGNMENTS FOR PIN 1 ORIENTATION IN TAPE

*All dimensions are nominal

Device	Package Type	Package Drawing	Pins	SPQ	Reel Diameter (mm)	Reel Width W1 (mm)	A0 (mm)	B0 (mm)	K0 (mm)	P1 (mm)	W (mm)	Pin1 Quadrant
TPS73201DBVR	SOT-23	DBV	5	3000	180.0	8.4	3.2	3.2	1.4	4.0	8.0	Q3
TPS73201DBVR	SOT-23	DBV	5	3000	178.0	9.0	3.3	3.2	1.4	4.0	8.0	Q3
TPS73201DBVT	SOT-23	DBV	5	250	179.0	8.4	3.2	3.2	1.4	4.0	8.0	Q3
TPS73201DBVT	SOT-23	DBV	5	250	178.0	9.0	3.23	3.17	1.37	4.0	8.0	Q3
TPS73201DCQR	SOT-223	DCQ	6	2500	330.0	12.4	7.1	7.45	1.88	8.0	12.0	Q3
TPS73201DRBR	SON	DRB	8	3000	330.0	12.4	3.3	3.3	1.0	8.0	12.0	Q2
TPS73201DRBR	SON	DRB	8	3000	330.0	12.4	3.3	3.3	1.1	8.0	12.0	Q2
TPS73201DRBT	SON	DRB	8	250	180.0	12.4	3.3	3.3	1.1	8.0	12.0	Q2
TPS73201DRBT	SON	DRB	8	250	180.0	12.4	3.3	3.3	1.0	8.0	12.0	Q2
TPS73213DBVR	SOT-23	DBV	5	3000	178.0	9.0	3.23	3.17	1.37	4.0	8.0	Q3
TPS73213DBVT	SOT-23	DBV	5	250	178.0	9.0	3.23	3.17	1.37	4.0	8.0	Q3
TPS73215DBVR	SOT-23	DBV	5	3000	178.0	9.0	3.23	3.17	1.37	4.0	8.0	Q3
TPS73215DBVT	SOT-23	DBV	5	250	178.0	9.0	3.23	3.17	1.37	4.0	8.0	Q3
TPS73215DCQR	SOT-223	DCQ	6	2500	330.0	12.4	7.1	7.45	1.88	8.0	12.0	Q3
TPS73216DBVT	SOT-23	DBV	5	250	179.0	8.4	3.2	3.2	1.4	4.0	8.0	Q3
TPS73218DBVR	SOT-23	DBV	5	3000	178.0	9.0	3.23	3.17	1.37	4.0	8.0	Q3
TPS73218DBVT	SOT-23	DBV	5	250	178.0	9.0	3.23	3.17	1.37	4.0	8.0	Q3
TPS73218DCQR	SOT-223	DCQ	6	2500	330.0	12.4	7.1	7.45	1.88	8.0	12.0	Q3

Device	Package Type	Package Drawing	Pins	SPQ	Reel Diameter (mm)	Reel Width W1 (mm)	A0 (mm)	B0 (mm)	K0 (mm)	P1 (mm)	W (mm)	Pin1 Quadrant
TPS73219DBVR	SOT-23	DBV	5	3000	178.0	9.0	3.23	3.17	1.37	4.0	8.0	Q3
TPS73219DBVT	SOT-23	DBV	5	250	178.0	9.0	3.23	3.17	1.37	4.0	8.0	Q3
TPS73225DBVR	SOT-23	DBV	5	3000	178.0	9.0	3.23	3.17	1.37	4.0	8.0	Q3
TPS73225DBVT	SOT-23	DBV	5	250	178.0	9.0	3.23	3.17	1.37	4.0	8.0	Q3
TPS73225DCQR	SOT-223	DCQ	6	2500	330.0	12.4	7.1	7.45	1.88	8.0	12.0	Q3
TPS73230DBVR	SOT-23	DBV	5	3000	178.0	9.0	3.23	3.17	1.37	4.0	8.0	Q3
TPS73230DBVT	SOT-23	DBV	5	250	178.0	9.0	3.23	3.17	1.37	4.0	8.0	Q3
TPS73230DCQR	SOT-223	DCQ	6	2500	330.0	12.4	7.1	7.45	1.88	8.0	12.0	Q3
TPS73233DBVR	SOT-23	DBV	5	3000	178.0	9.0	3.23	3.17	1.37	4.0	8.0	Q3
TPS73233DBVT	SOT-23	DBV	5	250	178.0	9.0	3.23	3.17	1.37	4.0	8.0	Q3
TPS73233DCQR	SOT-223	DCQ	6	2500	330.0	12.4	7.1	7.45	1.88	8.0	12.0	Q3
TPS73250DBVR	SOT-23	DBV	5	3000	178.0	9.0	3.23	3.17	1.37	4.0	8.0	Q3
TPS73250DBVT	SOT-23	DBV	5	250	178.0	9.0	3.23	3.17	1.37	4.0	8.0	Q3
TPS73250DCQR	SOT-223	DCQ	6	2500	330.0	12.4	7.1	7.45	1.88	8.0	12.0	Q3

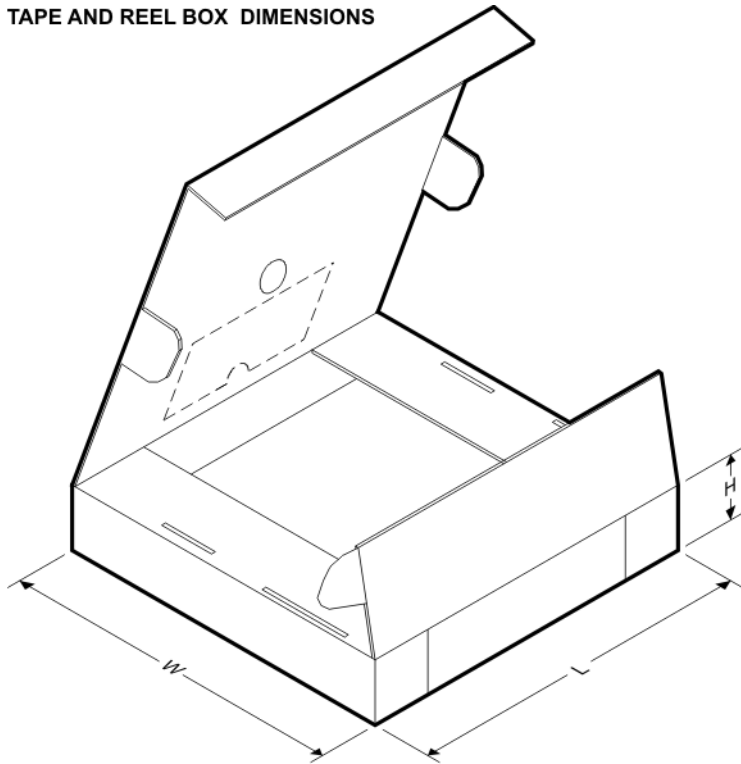
TAPE AND REEL BOX DIMENSIONS

*All dimensions are nominal

Device	Package Type	Package Drawing	Pins	SPQ	Length (mm)	Width (mm)	Height (mm)
TPS73201DBVR	SOT-23	DBV	5	3000	203.0	203.0	35.0
TPS73201DBVR	SOT-23	DBV	5	3000	180.0	180.0	18.0
TPS73201DBVT	SOT-23	DBV	5	250	203.0	203.0	35.0

Device	Package Type	Package Drawing	Pins	SPQ	Length (mm)	Width (mm)	Height (mm)
TPS73201DBVT	SOT-23	DBV	5	250	180.0	180.0	18.0
TPS73201DCQR	SOT-223	DCQ	6	2500	367.0	367.0	35.0
TPS73201DRBR	SON	DRB	8	3000	370.0	355.0	55.0
TPS73201DRBR	SON	DRB	8	3000	367.0	367.0	35.0
TPS73201DRBT	SON	DRB	8	250	210.0	185.0	35.0
TPS73201DRBT	SON	DRB	8	250	220.0	205.0	50.0
TPS73213DBVR	SOT-23	DBV	5	3000	180.0	180.0	18.0
TPS73213DBVT	SOT-23	DBV	5	250	180.0	180.0	18.0
TPS73215DBVR	SOT-23	DBV	5	3000	180.0	180.0	18.0
TPS73215DBVT	SOT-23	DBV	5	250	180.0	180.0	18.0
TPS73215DCQR	SOT-223	DCQ	6	2500	346.0	346.0	41.0
TPS73216DBVT	SOT-23	DBV	5	250	195.0	200.0	45.0
TPS73218DBVR	SOT-23	DBV	5	3000	180.0	180.0	18.0
TPS73218DBVT	SOT-23	DBV	5	250	180.0	180.0	18.0
TPS73218DCQR	SOT-223	DCQ	6	2500	367.0	367.0	35.0
TPS73219DBVR	SOT-23	DBV	5	3000	180.0	180.0	18.0
TPS73219DBVT	SOT-23	DBV	5	250	180.0	180.0	18.0
TPS73225DBVR	SOT-23	DBV	5	3000	180.0	180.0	18.0
TPS73225DBVT	SOT-23	DBV	5	250	180.0	180.0	18.0
TPS73225DCQR	SOT-223	DCQ	6	2500	346.0	346.0	41.0
TPS73230DBVR	SOT-23	DBV	5	3000	180.0	180.0	18.0
TPS73230DBVT	SOT-23	DBV	5	250	180.0	180.0	18.0
TPS73230DCQR	SOT-223	DCQ	6	2500	346.0	346.0	41.0
TPS73233DBVR	SOT-23	DBV	5	3000	180.0	180.0	18.0
TPS73233DBVT	SOT-23	DBV	5	250	180.0	180.0	18.0
TPS73233DCQR	SOT-223	DCQ	6	2500	367.0	367.0	35.0
TPS73250DBVR	SOT-23	DBV	5	3000	180.0	180.0	18.0
TPS73250DBVT	SOT-23	DBV	5	250	180.0	180.0	18.0
TPS73250DCQR	SOT-223	DCQ	6	2500	346.0	346.0	41.0

DCQ (R-PDSO-G6)

PLASTIC SMALL-OUTLINE



- NOTES:
- A. All linear dimensions are in inches (millimeters).
 - B. This drawing is subject to change without notice.
 - C. Controlling dimension in inches.
 - $\triangle D$ Body length and width dimensions are determined at the outermost extremes of the plastic body exclusive of mold flash, tie bar burrs, gate burrs, and interlead flash, but including any mismatch between the top and the bottom of the plastic body.
 - $\triangle E$ Lead width dimension does not include dambar protrusion.
 - $\triangle F$ Lead width and thickness dimensions apply to solder plated leads.
 - G. Interlead flash allow 0.008 inch max.
 - H. Gate burr/protrusion max. 0.006 inch.
 - I. Datums A and B are to be determined at Datum H.



- NOTES:
- All linear dimensions are in millimeters.
 - This drawing is subject to change without notice.
 - Publication IPC-SM-782 is recommended for alternate designs.
 - Laser cutting apertures with trapezoidal walls and also rounding corners will offer better paste release. Customers should contact their board assembly site for stencil design recommendations.
 - Customers should contact their board fabrication site for solder mask tolerances between and around signal pads.
 - Please refer to the product data sheet for specific via and thermal dissipation requirements.

DRB 8

GENERIC PACKAGE VIEW

VSON - 1 mm max height

PLASTIC SMALL OUTLINE - NO LEAD



Images above are just a representation of the package family, actual package may vary.
Refer to the product data sheet for package details.

4203482/L

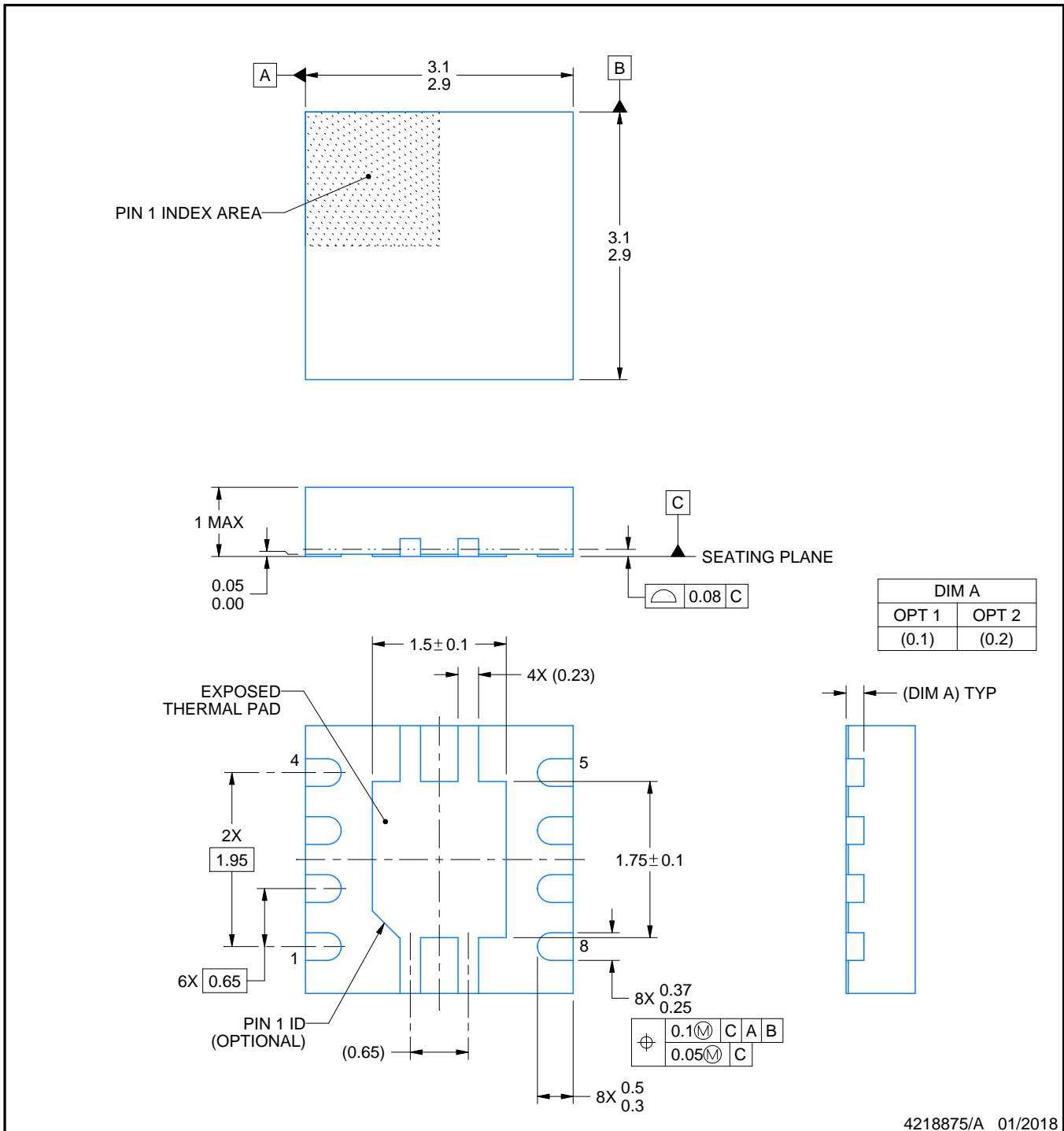

4218875/A 01/2018

NOTES:

1. All linear dimensions are in millimeters. Any dimensions in parenthesis are for reference only. Dimensioning and tolerancing per ASME Y14.5M.
2. This drawing is subject to change without notice.
3. The package thermal pad must be soldered to the printed circuit board for thermal and mechanical performance.

EXAMPLE BOARD LAYOUT

DRB0008A

VSON - 1 mm max height

PLASTIC SMALL OUTLINE - NO LEAD



LAND PATTERN EXAMPLE
EXPOSED METAL SHOWN
SCALE:20X

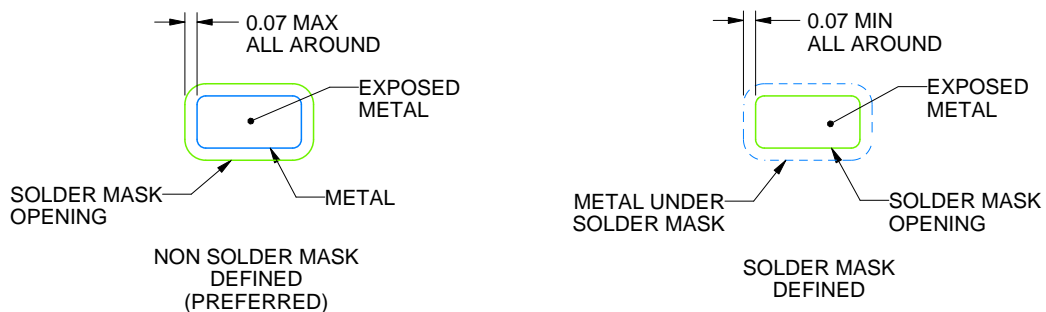

SOLDER MASK DETAILS

4218875/A 01/2018

NOTES: (continued)

4. This package is designed to be soldered to a thermal pad on the board. For more information, see Texas Instruments literature number SLUA271 (www.ti.com/lit/sluea271).
5. Vias are optional depending on application, refer to device data sheet. If any vias are implemented, refer to their locations shown on this view. It is recommended that vias under paste be filled, plugged or tented.

EXAMPLE STENCIL DESIGN

DRB0008A

VSON - 1 mm max height

PLASTIC SMALL OUTLINE - NO LEAD



SOLDER PASTE EXAMPLE
BASED ON 0.125 mm THICK STENCIL

EXPOSED PAD
84% PRINTED SOLDER COVERAGE BY AREA
SCALE:25X

4218875/A 01/2018

NOTES: (continued)

6. Laser cutting apertures with trapezoidal walls and rounded corners may offer better paste release. IPC-7525 may have alternate design recommendations.

EXAMPLE STENCIL DESIGN

DBV0005A

SOT-23 - 1.45 mm max height

SMALL OUTLINE TRANSISTOR



SOLDER PASTE EXAMPLE
BASED ON 0.125 mm THICK STENCIL
SCALE:15X

4214839/D 11/2018

NOTES: (continued)

7. Laser cutting apertures with trapezoidal walls and rounded corners may offer better paste release. IPC-7525 may have alternate design recommendations.
8. Board assembly site may have different recommendations for stencil design.

IMPORTANT NOTICE AND DISCLAIMER

TI PROVIDES TECHNICAL AND RELIABILITY DATA (INCLUDING DATASHEETS), DESIGN RESOURCES (INCLUDING REFERENCE DESIGNS), APPLICATION OR OTHER DESIGN ADVICE, WEB TOOLS, SAFETY INFORMATION, AND OTHER RESOURCES "AS IS" AND WITH ALL FAULTS, AND DISCLAIMS ALL WARRANTIES, EXPRESS AND IMPLIED, INCLUDING WITHOUT LIMITATION ANY IMPLIED WARRANTIES OF MERCHANTABILITY, FITNESS FOR A PARTICULAR PURPOSE OR NON-INFRINGEMENT OF THIRD PARTY INTELLECTUAL PROPERTY RIGHTS.

These resources are intended for skilled developers designing with TI products. You are solely responsible for (1) selecting the appropriate TI products for your application, (2) designing, validating and testing your application, and (3) ensuring your application meets applicable standards, and any other safety, security, or other requirements. These resources are subject to change without notice. TI grants you permission to use these resources only for development of an application that uses the TI products described in the resource. Other reproduction and display of these resources is prohibited. No license is granted to any other TI intellectual property right or to any third party intellectual property right. TI disclaims responsibility for, and you will fully indemnify TI and its representatives against, any claims, damages, costs, losses, and liabilities arising out of your use of these resources.

TI's products are provided subject to TI's Terms of Sale (www.ti.com/legal/termsofsale.html) or other applicable terms available either on ti.com or provided in conjunction with such TI products. TI's provision of these resources does not expand or otherwise alter TI's applicable warranties or warranty disclaimers for TI products.

Mailing Address: Texas Instruments, Post Office Box 655303, Dallas, Texas 75265
Copyright © 2019, Texas Instruments Incorporated

Looking for pricing, stock, or lifecycle information?

Click below to explore more details on WIN SOURCE:

 [View TPS73225DCQR on WIN SOURCE](#)

 [Texas Instruments](#) Information

Optimize Your Supply Chain with WIN SOURCE Solutions

-  Global Sourcing Solution
-  Obsolete Management
-  Cost Control Management
-  Shortage Management
-  Alternative Solution
-  Excess Inventory Management