



**THE DATASHEET OF
DS1245W-150**



FEATURES

- 10 years minimum data retention in the absence of external power
- Data is automatically protected during power loss
- Replaces 128k x 8 volatile static RAM, EEPROM or Flash memory
- Unlimited write cycles
- Low-power CMOS
- Read and write access times of 100ns
- Lithium energy source is electrically disconnected to retain freshness until power is applied for the first time
- Optional industrial temperature range of -40°C to +85°C, designated IND
- JEDEC standard 32-pin DIP package
- PowerCap Module (PCM) package
 - Directly surface-mountable module
 - Replaceable snap-on PowerCap provides lithium backup battery
 - Standardized pinout for all nonvolatile SRAM products
 - Detachment feature on PowerCap allows easy removal using a regular screwdriver

PIN ASSIGNMENT

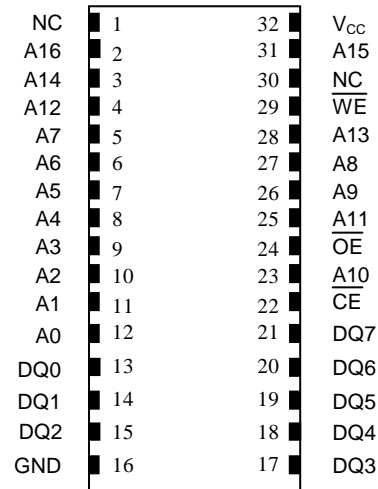

32-PIN Encapsulated Package
740-Mil Extended

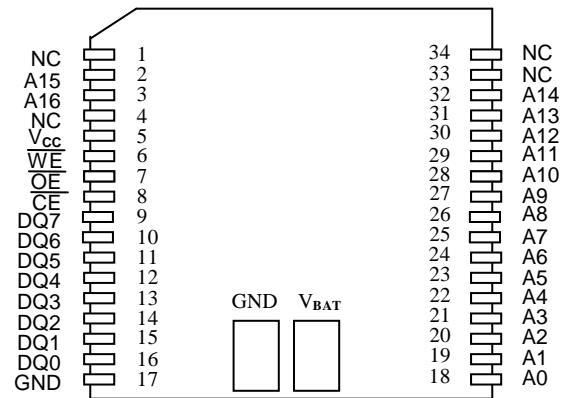

34-Pin PowerCap Module (PCM)
(Uses DS9034PC+ or DS9034PCI+ PowerCap)

PIN DESCRIPTION

A0 - A16	- Address Inputs
DQ0 - DQ7	- Data In/Data Out
$\overline{\text{CE}}$	- Chip Enable
$\overline{\text{WE}}$	- Write Enable
$\overline{\text{OE}}$	- Output Enable
V _{CC}	- Power (+3.3V)
GND	- Ground
NC	- No Connect

DESCRIPTION

The DS1245W 3.3V 1024k Nonvolatile SRAM is a 1,048,576-bit, fully static, nonvolatile SRAM organized as 131,072 words by 8 bits. Each NV SRAM has a self-contained lithium energy source and control circuitry which constantly monitors V_{CC} for an out-of-tolerance condition. When such a condition occurs, the lithium energy source is automatically switched on and write protection is unconditionally enabled to prevent data corruption. DIP-package DS1245W devices can be used in place of existing 128k x 8 static RAMs directly conforming to the popular byte-wide 32-pin DIP standard. DS1245W devices in the PowerCap Module package are directly surface mountable and are normally paired with a DS9034PC PowerCap to form a complete Nonvolatile SRAM module. There is no limit on the number of write cycles that can be executed and no additional support circuitry is required for microprocessor interfacing.

READ MODE

The DS1245W executes a read cycle whenever \overline{WE} (Write Enable) is inactive (high) and \overline{CE} (Chip Enable) and \overline{OE} (Output Enable) are active (low). The unique address specified by the 17 address inputs ($A_0 - A_{16}$) defines which of the 131,072 bytes of data is to be accessed. Valid data will be available to the eight data output drivers within t_{ACC} (Access Time) after the last address input signal is stable, providing that \overline{CE} and \overline{OE} (Output Enable) access times are also satisfied. If \overline{OE} and \overline{CE} access times are not satisfied, then data access must be measured from the later occurring signal (\overline{CE} or \overline{OE}) and the limiting parameter is either t_{CO} for \overline{CE} or t_{OE} for \overline{OE} rather than address access.

WRITE MODE

The DS1245W executes a write cycle whenever the \overline{WE} and \overline{CE} signals are active (low) after address inputs are stable. The later occurring falling edge of \overline{CE} or \overline{WE} will determine the start of the write cycle. The write cycle is terminated by the earlier rising edge of \overline{CE} or \overline{WE} . All address inputs must be kept valid throughout the write cycle. \overline{WE} must return to the high state for a minimum recovery time (t_{WR}) before another cycle can be initiated. The \overline{OE} control signal should be kept inactive (high) during write cycles to avoid bus contention. However, if the output drivers are enabled (\overline{CE} and \overline{OE} active) then \overline{WE} will disable the outputs in t_{ODW} from its falling edge.

DATA RETENTION MODE

The DS1245W provides full functional capability for V_{CC} greater than 3.0 volts and write protects by 2.8 volts. Data is maintained in the absence of V_{CC} without any additional support circuitry. The nonvolatile static RAMs constantly monitor V_{CC} . Should the supply voltage decay, the NV SRAMs automatically write protect themselves, all inputs become “don’t care,” and all outputs become high impedance. As V_{CC} falls below approximately 3.0 volts, a power switching circuit connects the lithium energy source to RAM to retain data. During power-up, when V_{CC} rises above approximately 2.5 volts, the power switching circuit connects external V_{CC} to RAM and disconnects the lithium energy source. Normal RAM operation can resume after V_{CC} exceeds 3.0 volts.

FRESHNESS SEAL

Each DS1245W device is shipped from Maxim with its lithium energy source disconnected, guaranteeing full energy capacity. When V_{CC} is first applied at a level greater than 3.0 volts, the lithium energy source is enabled for battery back-up operation.

PACKAGES

The DS1245W is available in two packages: 32-pin DIP and 34-pin PowerCap Module (PCM). The 32-pin DIP integrates a lithium battery, an SRAM memory and a nonvolatile control function into a single package with a JEDEC-standard 600-mil DIP pinout. The 34-pin PowerCap Module integrates SRAM

memory and nonvolatile control into a module base along with contacts for connection to the lithium battery in the DS9034PC PowerCap. The PowerCap Module package design allows a DS1245W PCM device to be surface mounted without subjecting its lithium backup battery to destructive high-temperature reflow soldering. After a DS1245W module base is reflow soldered, a DS9034PC PowerCap is snapped on top of the base to form a complete Nonvolatile SRAM module. The DS9034PC is keyed to prevent improper attachment. DS1245W module bases and DS9034PC PowerCaps are ordered separately and shipped in separate containers. See the DS9034PC data sheet for further information.

ABSOLUTE MAXIMUM RATINGS

Voltage on Any Pin Relative to Ground	-0.3V to +4.6V
Operating Temperature Range	
Commercial:	0°C to +70°C
Industrial:	-40°C to +85°C
Storage Temperature Range	
EDIP	-40°C to +85°C
PowerCap	-55°C to +125°C
Lead Temperature (soldering, 10s)	+260°C
Soldering Temperature (reflow, PowerCap)	+260°C
Note: EDIP is wave or hand soldered only.	

This is a stress rating only and functional operation of the device at these or any other conditions above those indicated in the operation sections of this specification is not implied. Exposure to absolute maximum rating conditions for extended periods of time may affect reliability.

RECOMMENDED DC OPERATING CONDITIONS(t_A: See Note 10)

PARAMETER	SYMBOL	MIN	TYP	MAX	UNITS	NOTES
Power Supply Voltage	V _{CC}	3.0	3.3	3.6	V	
Logic 1	V _{IH}	2.2		V _{CC}	V	
Logic 0	V _{IL}	0.0		0.4	V	

DC ELECTRICAL CHARACTERISTICS(t_A: See Note 10) (V_{CC}=3.3V)

□□0.3V)

PARAMETER	SYMBOL	MIN	TYP	MAX	UNITS	NOTES
Input Leakage Current	I _{IL}	-1.0		+1.0	μA	
I/O Leakage Current $\overline{CE} \geq V_{IH} \leq V_{CC}$	I _{IO}	-1.0		+1.0	μA	
Output Current @ 2.2V	I _{OH}	-1.0			mA	
Output Current @ 0.4V	I _{OL}	2.0			mA	
Standby Current $\overline{CE}=2.2V$	I _{CCS1}		50	250	μA	
Standby Current $\overline{CE}=V_{CC}-0.2V$	I _{CCS2}		30	150	μA	
Operating Current	I _{CCO1}			50	mA	
Write Protection Voltage	V _{TP}	2.8	2.9	3.0	V	

CAPACITANCE(t_A=25□C)

PARAMETER	SYMBOL	MIN	TYP	MAX	UNITS	NOTES
Input Capacitance	C _{IN}		5	10	pF	
Input/Output Capacitance	C _{I/O}		5	10	pF	

AC ELECTRICAL CHARACTERISTICS (T_A : See Note 10) ($V_{CC} = 3.3V \pm 0.3V$)

PARAMETER	SYMBOL	DS1245W-100		UNITS	NOTES
		MIN	MAX		
Read Cycle Time	t_{RC}	100		ns	
Access Time	t_{ACC}		100	ns	
\overline{OE} to Output Valid	t_{OE}		50	ns	
\overline{CE} to Output Valid	t_{CO}		100	ns	
\overline{OE} or \overline{CE} to Output Active	t_{COE}	5		ns	5
Output High Z from Deselection	t_{OD}		35	ns	5
Output Hold from Address Change	t_{OH}	5		ns	
Write Cycle Time	t_{WC}	100		ns	
Write Pulse Width	t_{WP}	75		ns	3
Address Setup Time	t_{AW}	0		ns	
Write Recovery Time	t_{WR1}	5		ns	12
	t_{WR2}	20		ns	13
Output High Z from \overline{WE}	t_{ODW}		35	ns	5
Output Active from \overline{WE}	t_{OEw}	5		ns	5
Data Setup Time	t_{DS}	40		ns	4
Data Hold Time	t_{DH1}	0		ns	12
	t_{DH2}	20		ns	13

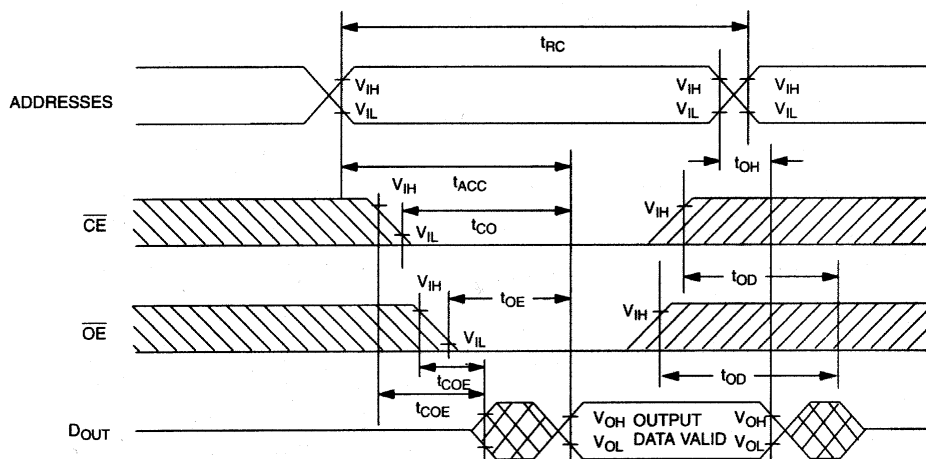
READ CYCLE

SEE NOTE 1

WRITE CYCLE 1

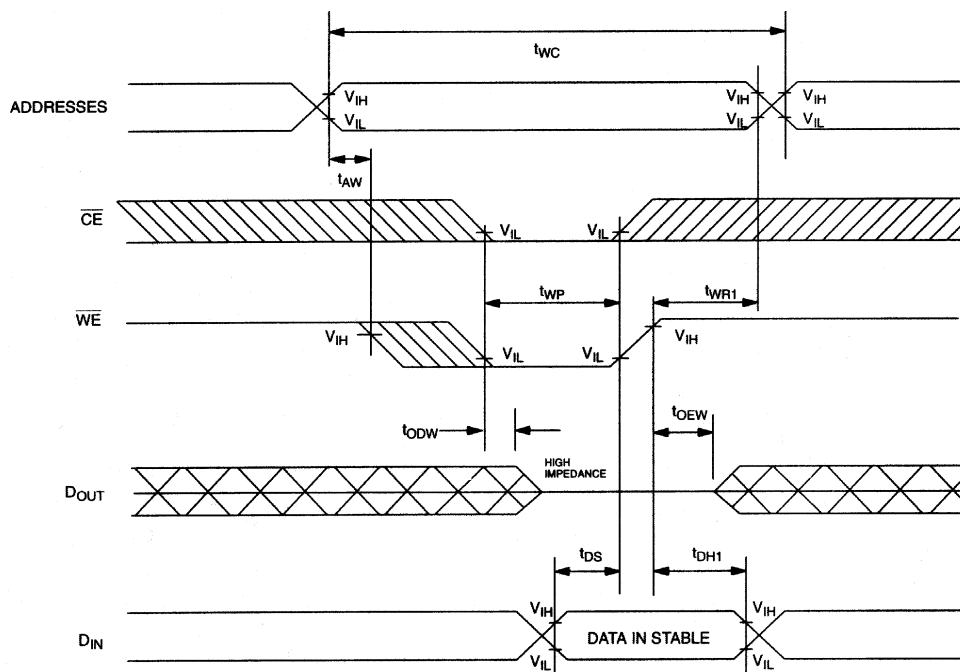

SEE NOTES 2, 3, 4, 6, 7, 8 AND 12

WRITE CYCLE 2

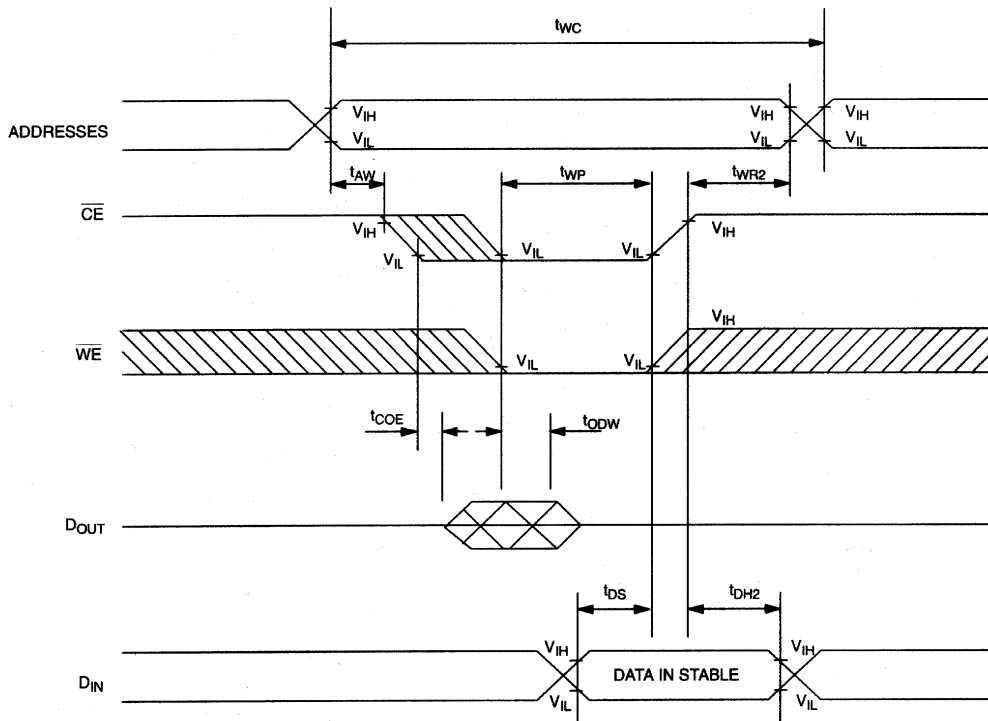

SEE NOTES 2, 3, 4, 6, 7, 8 AND 12

POWER-DOWN/POWER-UP CONDITION

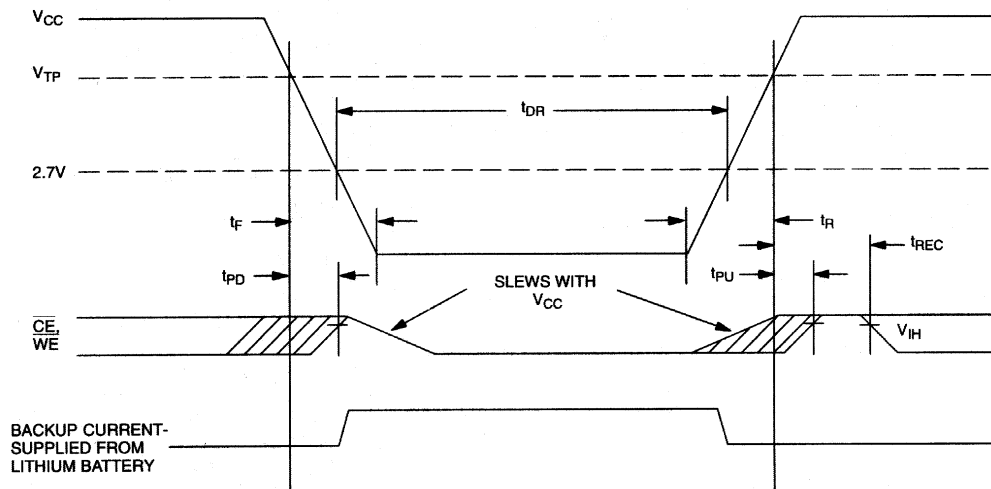

POWER-DOWN/POWER-UP TIMING(T_A: See Note 10)

PARAMETER	SYMBOL	MIN	TYP	MAX	UNITS	NOTES
V _{CC} Fail Detect to $\overline{\text{CE}}$ and $\overline{\text{WE}}$ Inactive	t _{PD}			1.5	μs	11
V _{CC} slew from V _{TP} to 0V	t _F	150		15	ms	
V _{CC} slew from 0V to V _{TP}	t _R	150			μs	
V _{CC} Valid to $\overline{\text{CE}}$ and $\overline{\text{WE}}$ Inactive	t _{PU}			2	ms	
V _{CC} Valid to End of Write Protection	t _{REC}			125	ms	

(T_A = +25°C)

PARAMETER	SYMBOL	MIN	TYP	MAX	UNITS	NOTES
Expected Data Retention Time	t _{DR}	10			years	9

WARNING:

Under no circumstance are negative undershoots, of any amplitude, allowed when device is in battery backup mode.

NOTES:

- $\overline{\text{WE}}$ is high for a Read Cycle.
- $\overline{\text{OE}} = V_{\text{IH}}$ or V_{IL} . If $\overline{\text{OE}} = V_{\text{IH}}$ during write cycle, the output buffers remain in a high impedance state.
- t_{WP} is specified as the logical AND of $\overline{\text{CE}}$ and $\overline{\text{WE}}$. t_{WP} is measured from the latter of $\overline{\text{CE}}$ or $\overline{\text{WE}}$ going low to the earlier of $\overline{\text{CE}}$ or $\overline{\text{WE}}$ going high.
- t_{DH}, t_{DS} are measured from the earlier of $\overline{\text{CE}}$ or $\overline{\text{WE}}$ going high.
- These parameters are sampled with a 5 pF load and are not 100% tested.
- If the $\overline{\text{CE}}$ low transition occurs simultaneously with or latter than the $\overline{\text{WE}}$ low transition, the output buffers remain in a high impedance state during this period.
- If the $\overline{\text{CE}}$ high transition occurs prior to or simultaneously with the $\overline{\text{WE}}$ high transition, the output buffers remain in high impedance state during this period.
- If $\overline{\text{WE}}$ is low or the $\overline{\text{WE}}$ low transition occurs prior to or simultaneously with the $\overline{\text{CE}}$ low transition, the output buffers remain in a high impedance state during this period.
- Each DS1245W has a built-in switch that disconnects the lithium source until V_{CC} is first applied by the user. The expected t_{DR} is defined as accumulative time in the absence of V_{CC} starting from the time power is first applied by the user.
- All AC and DC electrical characteristics are valid over the full operating temperature range. For commercial products, this range is 0°C to 70°C. For industrial products (IND), this range is -40°C to +85°C.
- In a power-down condition the voltage on any pin may not exceed the voltage on V_{CC}.
- t_{WR1} and t_{DH1} are measured from $\overline{\text{WE}}$ going high.
- t_{WR2} and t_{DH2} are measured from $\overline{\text{CE}}$ going high.
- DS1245 modules are recognized by Underwriters Laboratories (UL) under file E99151.

DC TEST CONDITIONS

Outputs Open

Cycle = 200ns for operating current

All voltages are referenced to ground

AC TEST CONDITIONS

Output Load: 100 pF + 1TTL Gate

Input Pulse Levels: 0 to 2.7V

Timing Measurement Reference Levels

Input: 1.5V

Output: 1.5V

Input pulse Rise and Fall Times: 5ns

ORDERING INFORMATION

PART	TEMP RANGE	SUPPLY TOLERANCE	PIN-PACKAGE	SPEED GRADE (ns)
DS1245W-100+	0°C to +70°C	3.3V ± 0.3V	32 740 EDIP	100
DS1245WP-100+	0°C to +70°C	3.3V ± 0.3V	34 PowerCap*	100
DS1245W-100IND+	-40°C to +85°C	3.3V ± 0.3V	32 740 EDIP	100
DS1245WP-100IND+	-40°C to +85°C	3.3V ± 0.3V	34 PowerCap*	100

+Denotes a lead(Pb)-free/RoHS-compliant package.

*DS9034PC+ or DS9034PCI+ (PowerCap) required. Must be ordered separately.

PACKAGE INFORMATION

For the latest package outline information and land patterns, go to www.maxim-ic.com/packages. Note that a “+”, “#”, or “-” in the package code indicates RoHS status only. Package drawings may show a different suffix character, but the drawing pertains to the package regardless of RoHS status.



PACKAGE TYPE	PACKAGE CODE	OUTLINE NO.	LAND PATTERN NO.
32 EDIP	MDT32+6	21-0245	—
34 PCAP	PC2+3	21-0246	—

REVISION HISTORY

REVISION DATE	DESCRIPTION	PAGES CHANGED
121907	Added the <i>Package Information</i> table; removed the DIP module package drawing and dimension table	8
11/10	Updated the storage information, soldering temperature, and lead temperature information in the <i>Absolute Maximum Ratings</i> section; removed the -150 MIN/MAX information from the <i>AC Electrical Characteristics</i> table; updated the <i>Ordering Information</i> table (removed -150 parts and leaded -100 parts); removed the PowerCap module drawings and updated the <i>Package Information</i> table	1, 4, 5, 9

Looking for pricing, stock, or lifecycle information?

Click below to explore more details on WIN SOURCE:

-  [View DS1245W-150](#) on WIN SOURCE
-  [Maxim Integrated](#) Information

Optimize Your Supply Chain with WIN SOURCE Solutions

-  Global Sourcing Solution
-  Obsolete Management
-  Cost Control Management
-  Shortage Management
-  Alternative Solution
-  Excess Inventory Management