

AN1101SSM

CMOS single power supply

■ Overview

AN1101SSM is an operational amplifier with a single power supply by CMOS diffusion process.

It has low current-consumption compared to general purpose operational amplifier by bipolar diffusion process. 0 V to V_{DD} is available for both input voltage and output voltage. And this IC is widely applicable to the battery-driven equipment and to many amplifier circuits which adopt small package products.

■ Features

- Low current-consumption: $I_{DD} = 55 \mu\text{A}$ (typ.), $V_{DD} = 3 \text{ V}$
- Operating input/output voltage range: 0 V to V_{DD}
- Small offset voltage: 0.5 mV (typ.)
- Small input bias current: 1 pA (typ.)
- Operating supply voltage range:
2.5 V to 5.5 V or $\pm 1.25 \text{ V}$ to $\pm 2.75 \text{ V}$

■ Applications

- Various small-size general consumer electronics equipment

■ Block Diagram

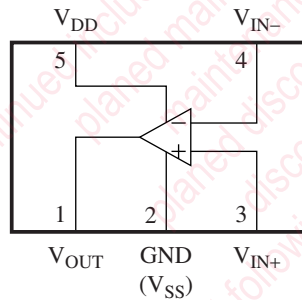

■ Pin Descriptions

Pin No.	Symbol	Description
1	V_{OUT}	Output
2	GND (V_{SS})	Ground, V_{SS} (negative supply) at using two power supply
3	V_{IN+}	Input (positive)
4	V_{IN-}	Input (negative)
5	V_{DD}	Power supply

Note) The AN1101SSM has been designed for general consumer electronics equipment, not for the specific one requiring such a high reliability that may prevent it from threatening the human lives.

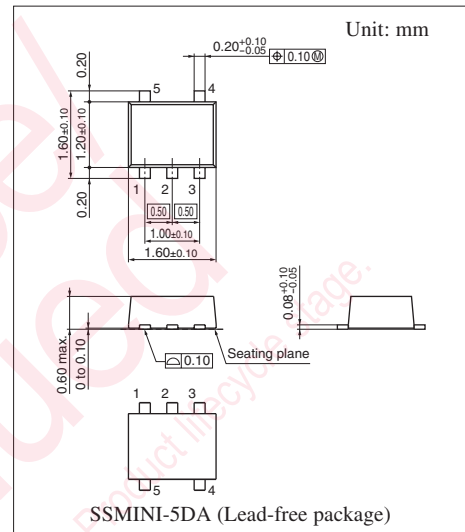

■ Absolute Maximum Ratings

Parameter	Symbol	Rating	Unit
Supply voltage	V_{DD}	5.6	V
Differential input voltage	DV_{IN}	± 5.6	V
Input voltage	V_{IN}	V_{SS} to V_{DD}	V
Supply current	I_{DD}	—	mA
Power dissipation *2	P_D	50	mW
Operating ambient temperature *1	T_{opr}	-30 to +85	°C
Storage temperature *1	T_{stg}	-55 to +125	°C

Note) 1. *1: Except for the operating ambient temperature and storage temperature, all ratings are for $T_a = 25^\circ\text{C}$.

*2: The value at $T_a = +85^\circ\text{C}$.

2. This IC is not suitable for car electrical equipment.

■ Recommended Operating Range

Parameter	Symbol	Range	Unit
Supply voltage	V_{DD}	2.5 to 5.5	V
		± 1.25 to ± 2.75	

■ Electrical Characteristics at $V_{DD} = 3.0\text{ V}$, $V_{SS} = \text{GND}$, $T_a = 25^\circ\text{C} \pm 2^\circ\text{C}$

Parameter	Symbol	Conditions	Min	Typ	Max	Unit
Input offset voltage	V_{IO}	Buffer circuit	—	0.5	5.5	mV
Common-mode input voltage	CMV_{IN}	$R_S = 10\text{ k}\Omega$, $R_F = 10\text{ k}\Omega$	0	—	3	V
Open-loop gain	GV	$f = 100\text{ Hz}$	60	90	—	dB
Maximum output amplitude voltage 1	V_{OH}	$R_L \geq 10\text{ k}\Omega$	2.90	2.98	—	V
Maximum output amplitude voltage 2	V_{OL}	$R_L \geq 10\text{ k}\Omega$	—	0.01	0.05	V
Common-mode input voltage rejection ratio	CMRR	$V_{IN} = 0.0\text{ V}$ to 3.0 V , $R_S = R_F = 10\text{ k}\Omega$	50	65	—	dB
Supply voltage ripple rejection ratio *	SVRR	$V_{DD} = 2.5\text{ V}$ to 5.5 V	55	70	—	dB
Supply current	I_{DD}	No load	—	55	100	μA

Note) * : Except for the supply voltage ripple rejection ratio (SVRR), $V_{DD} = 3\text{ V}$.

• Design reference data

Note) The characteristics listed below are theoretical values based on the IC design and are not guaranteed.

Parameter	Symbol	Conditions	Reference	Unit
Offset current	I_O	—	1	pA
Input bias current	I_{IO}	—	1	pA
Slew rate	SR	$R_L \geq 10\text{ k}\Omega$	0.35	V/ μs
Zero-cross frequency	f_T	$A_V = 1$	0.8	MHz

■ Technical Data

- $P_D - T_a$ curve of SSMINI-5DA

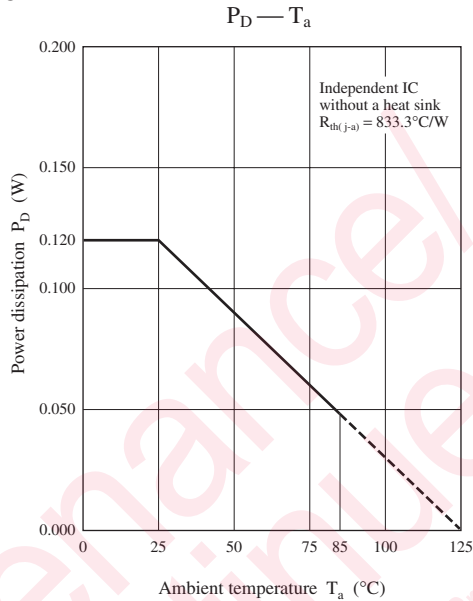

• Main characteristics

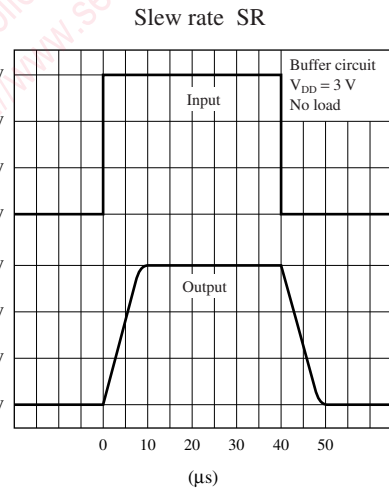
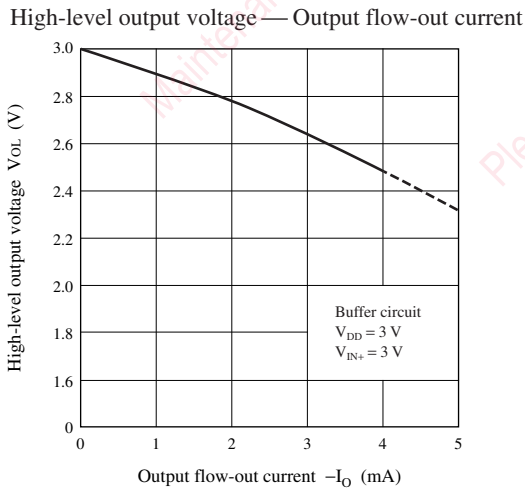
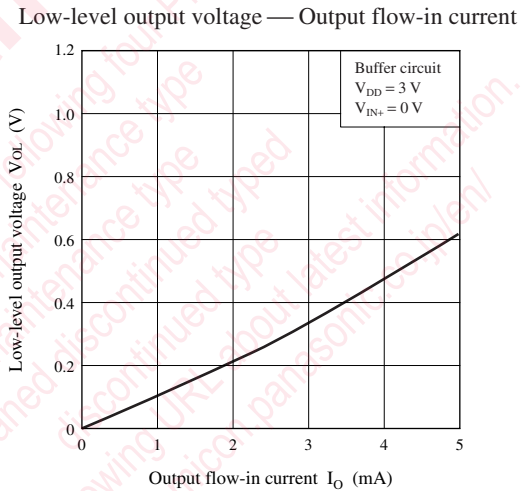
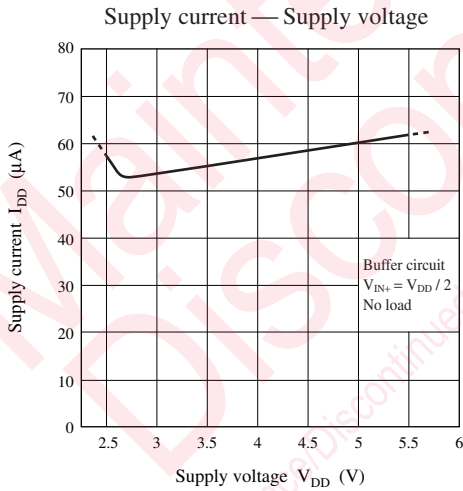

■ Technical Data (continued)

• Main characteristics (continued)

Offset voltage — Ambient temperature

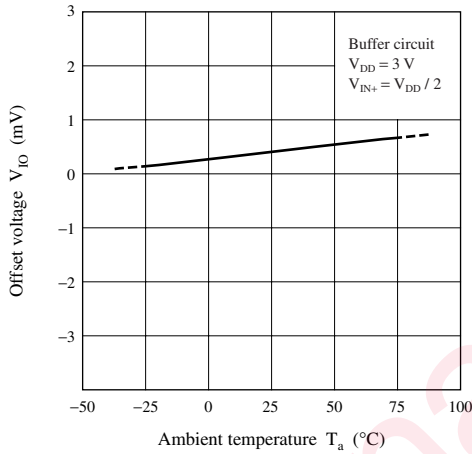

Supply current — Ambient temperature

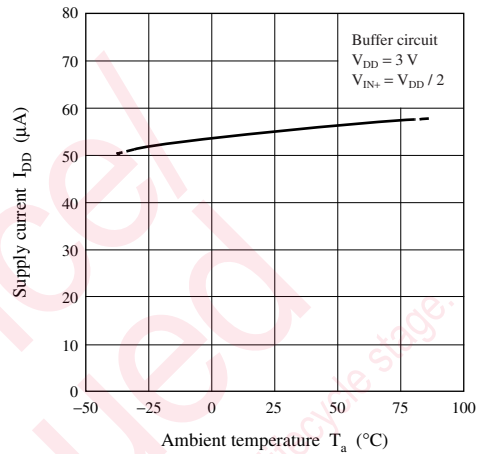

Voltage gain · Phase — Frequency characteristics

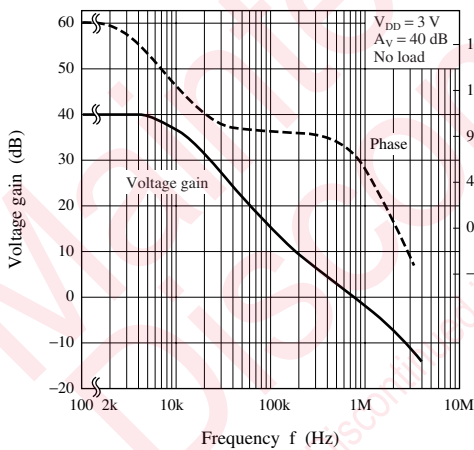

■ Application Circuit Example

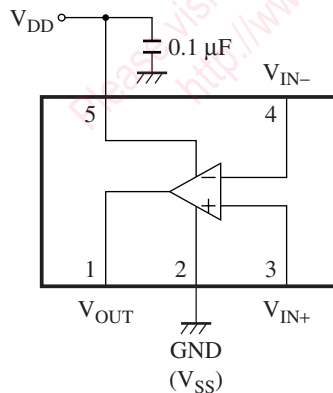

utions in using the technical information and scribed in this book

s book is to be exported or provided to non-residents, the laws and
rd to security export control, must be observed.

ly to show the main characteristics and application circuit examples
l property right or other right owned by our company or any other
any as to the infringement upon any such right owned by any other
rmation described in this book.

standard applications or general electronic equipment (such as office
and household appliances).

ng applications:

biles, traffic control equipment, combustion equipment, life support
reliability are required, or if the failure or malfunction of the prod-

ck are subject to change without notice for modification and/or im-
use of the products, therefore, ask for the most up-to-date Product
atisfy your requirements.

bsolute maximum rating and the guaranteed operating conditions
(.). Especially, please be careful not to exceed the range of absolute
er-off and mode-switching. Otherwise, we will not be liable for any

take into the consideration of incidence of break down and failure
n the systems such as redundant design, arresting the spread of fire
al injury, fire, social damages, for example, by using the products.

own and characteristics change due to external factors (ESD, EOS,
mounting or at customer's process. When using products for which
shelf life and the elapsed time since first opening the packages.

ly or partially, without the prior written permission of Matsushita







Looking for pricing, stock, or lifecycle information?

Click below to explore more details on WIN SOURCE:

 [View AN1101SSMTXL on WIN SOURCE](#)

 [Panasonic Information](#)

Optimize Your Supply Chain with WIN SOURCE Solutions

-  Global Sourcing Solution
-  Obsolete Management
-  Cost Control Management
-  Shortage Management
-  Alternative Solution
-  Excess Inventory Management