



**THE DATASHEET OF
NCP5109ADR2G**



NCP5109A, NCP5109B

High Voltage, High and Low Side Driver

The NCP5109 is a high voltage gate driver IC providing two outputs for direct drive of 2 N-channel power MOSFETs or IGBTs arranged in a half-bridge configuration version B or any other high-side + low-side configuration version A.

It uses the bootstrap technique to ensure a proper drive of the high-side power switch. The driver works with 2 independent inputs.

Features

- High Voltage Range: Up to 200 V
- dV/dt Immunity ± 50 V/nsec
- Negative Current Injection Characterized Over the Temperature Range
- Gate Drive Supply Range from 10 V to 20 V
- High and Low Drive Outputs
- Output Source / Sink Current Capability 250 mA / 500 mA
- 3.3 V and 5 V Input Logic Compatible
- Up to V_{CC} Swing on Input Pins
- Extended Allowable Negative Bridge Pin Voltage Swing to -10 V for Signal Propagation
- Matched Propagation Delays Between Both Channels
- Outputs in Phase with the Inputs
- Independent Logic Inputs to Accommodate All Topologies (Version A)
- Cross Conduction Protection with 100 ns Internal Fixed Dead Time (Version B)
- Under V_{CC} LockOut (UVLO) for Both Channels
- Pin-to-Pin Compatible with Industry Standards
- These are Pb-Free Devices

Typical Applications

- Half-Bridge Power Converters
- Any Complementary Drive Converters (Asymmetrical Half-Bridge, Active Clamp) (A Version Only).
- Full-Bridge Converters



ON Semiconductor®

www.onsemi.com

MARKING DIAGRAMS



**SOIC-8
D SUFFIX
CASE 751**

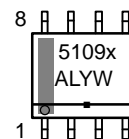

**DFN10
MN SUFFIX
CASE 506DH**

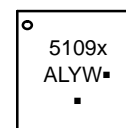

5109 = Specific Device Code
 x = A or B version
 A = Assembly Location
 L = Wafer Lot
 Y = Year
 W = Work Week
 ■ = Pb-Free Package

(Note: Microdot may be in either location)

PINOUT INFORMATION

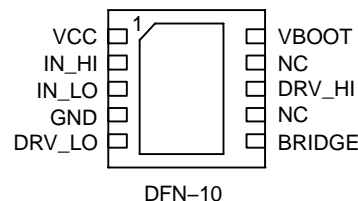
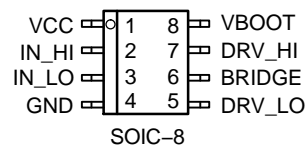

ORDERING INFORMATION

See detailed ordering and shipping information on page 16 of this data sheet.

NCP5109A, NCP5109B

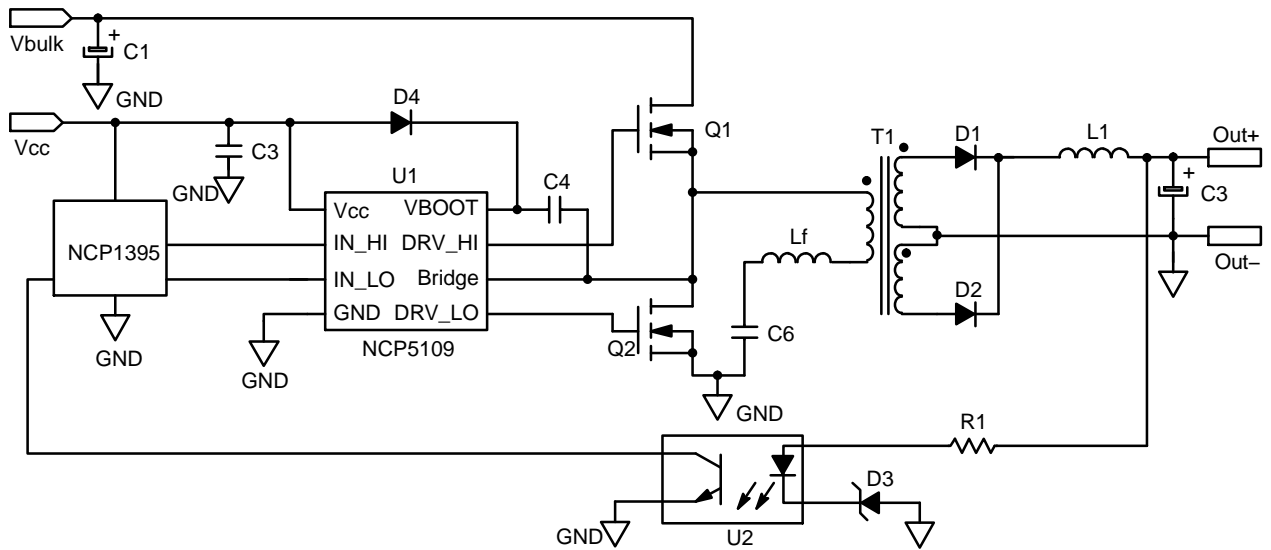

Figure 1. Typical Application Resonant Converter (LLC type)

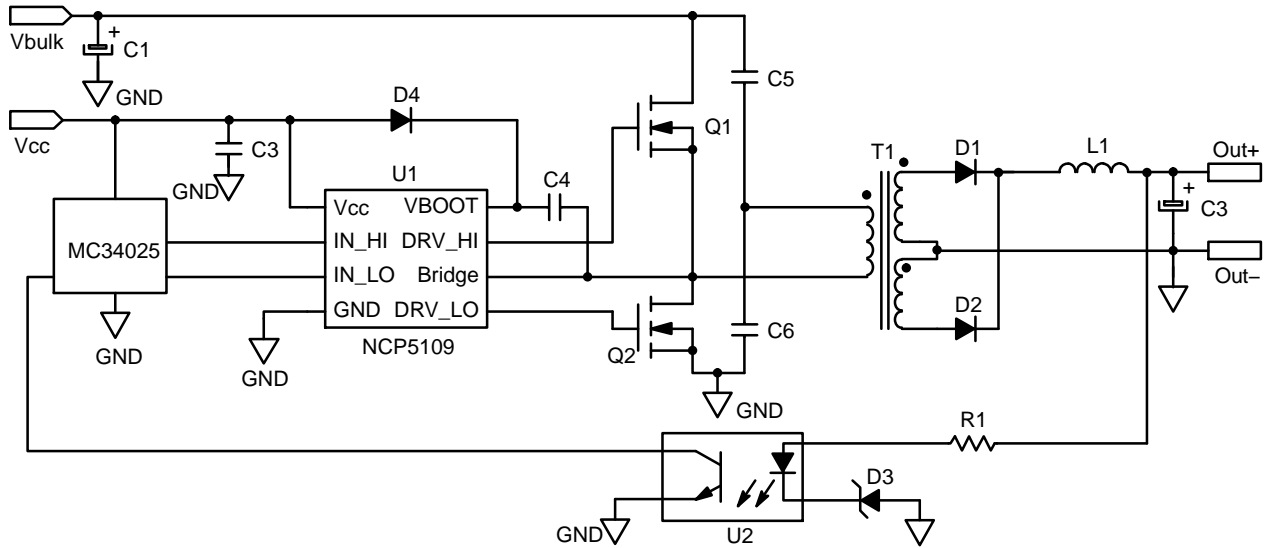

Figure 2. Typical Application Half Bridge Converter

NCP5109A, NCP5109B

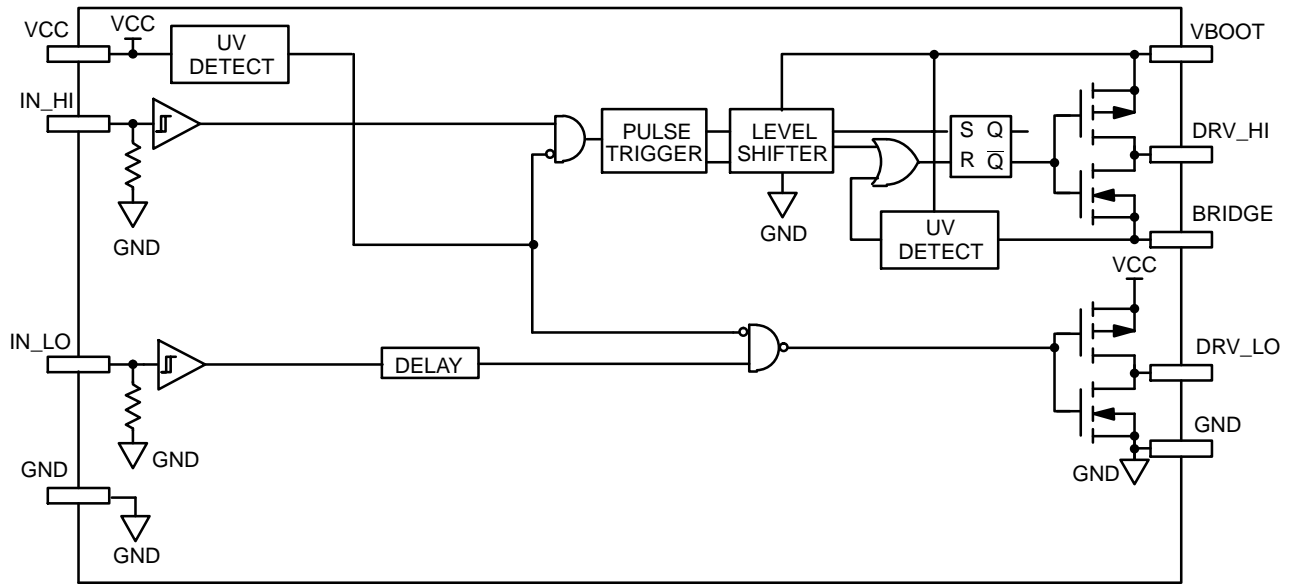

Figure 3. Detailed Block Diagram: Version A

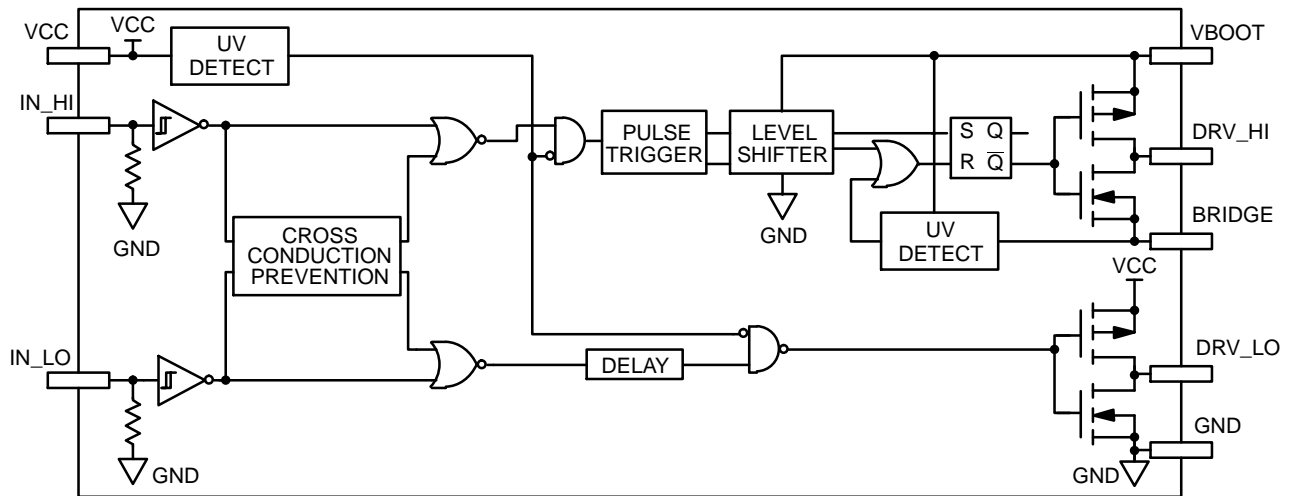

Figure 4. Detailed Block Diagram: Version B

PIN DESCRIPTION

| Pin Name | Description |
|-------------------|--|
| IN_HI | Logic Input for High Side Driver Output in Phase |
| IN_LO | Logic Input for Low Side Driver Output in Phase |
| GND | Ground |
| DRV_LO | Low Side Gate Drive Output |
| V _{CC} | Low Side and Main Power Supply |
| V _{BOOT} | Bootstrap Power Supply |
| DRV_HI | High Side Gate Drive Output |
| BRIDGE | Bootstrap Return or High Side Floating Supply Return |
| NC | Removed for creepage distance (DFN package only) |

NCP5109A, NCP5109B

MAXIMUM RATINGS

| Rating | Symbol | Value | Unit |
|------------------------|--|---|------|
| V_{CC} | Main power supply voltage | -0.3 to 20 | V |
| $V_{CC_transient}$ | Main transient power supply voltage: $I_{V_{CC_max}} = 5 \text{ mA}$ during 10 ms | 23 | V |
| V_{BRIDGE} | VHV: High Voltage BRIDGE pin | -1 to 200 | V |
| V_{BRIDGE} | Allowable Negative Bridge Pin Voltage for IN_LO Signal Propagation to DRV_LO (see characterization curves for detailed results) | -10 | V |
| $V_{BOOT_V_{BRIDGE}}$ | VHV: Floating supply voltage | -0.3 to 20 | V |
| V_{DRV_HI} | VHV: High side output voltage | $V_{BRIDGE} - 0.3$ to $V_{BOOT} + 0.3$ | V |
| V_{DRV_LO} | Low side output voltage | -0.3 to $V_{CC} + 0.3$ | V |
| dV_{BRIDGE}/dt | Allowable output slew rate | 50 | V/ns |
| V_{IN_XX} | Inputs IN_HI, IN_LO | -1.0 to $V_{CC} + 0.3$ | V |
| | ESD Capability: | | |
| | - HBM model (all pins except pins 6-7-8 in 8 pins package or 11-12-13 in 14 pins package) | 2 | kV |
| | - Machine model (all pins except pins 6-7-8 in 8 pins package or 11-12-13 in 14 pins package) | 200 | V |
| | Latch up capability per JEDEC JESD78 | | |
| $R_{\theta JA}$ | Power dissipation and Thermal characteristics SO-8: Thermal Resistance, Junction-to-Air DFN10 3x3: Thermal Resistance, Junction-to-Ambient 1 Oz Cu 50 mm ² Printed Circuit Copper Clad | 178 172 | °C/W |
| T_{ST} | Storage Temperature Range | -55 to +150 | °C |
| T_{J_max} | Maximum Operating Junction Temperature | +150 | °C |

Stresses exceeding those listed in the Maximum Ratings table may damage the device. If any of these limits are exceeded, device functionality should not be assumed, damage may occur and reliability may be affected.

NCP5109A, NCP5109B

ELECTRICAL CHARACTERISTIC ($V_{CC} = V_{boot} = 15\text{ V}$, $V_{GND} = V_{bridge}$, $-40^{\circ}\text{C} < T_J < 125^{\circ}\text{C}$, Outputs loaded with 1 nF)

| Rating | Symbol | $T_J -40^{\circ}\text{C to } 125^{\circ}\text{C}$ | | | Units |
|--------|--------|---|-----|-----|-------|
| | | Min | Typ | Max | |

OUTPUT SECTION

| | | | | | |
|--|-----------------|---|-----|-----|----------|
| Output high short circuit pulsed current $V_{DRV} = 0\text{ V}$, $PW \leq 10\ \mu\text{s}$ (Note 1) | $I_{DRVsource}$ | – | 250 | – | mA |
| Output low short circuit pulsed current $V_{DRV} = V_{CC}$, $PW \leq 10\ \mu\text{s}$ (Note 1) | $I_{DRVsink}$ | – | 500 | – | mA |
| Output resistor (Typical value @ 25°C) Source | R_{OH} | – | 30 | 60 | Ω |
| Output resistor (Typical value @ 25°C) Sink | R_{OL} | – | 10 | 20 | Ω |
| High level output voltage, $V_{BIAS} - V_{DRV_XX}$ @ $I_{DRV_XX} = 20\text{ mA}$ | V_{DRV_H} | – | 0.7 | 1.6 | V |
| Low level output voltage V_{DRV_XX} @ $I_{DRV_XX} = 20\text{ mA}$ | V_{DRV_L} | – | 0.2 | 0.6 | V |

DYNAMIC OUTPUT SECTION

| | | | | | |
|---|------------|----------|--------|--------|----|
| Turn-on propagation delay ($V_{bridge} = 0\text{ V}$) | t_{ON} | – | 100 | 170 | ns |
| Turn-off propagation delay ($V_{bridge} = 0\text{ V}$ or 50 V) (Note 2) | t_{OFF} | – | 100 | 170 | ns |
| Output voltage rise time (from 10% to 90% @ $V_{CC} = 15\text{ V}$) with 1 nF load | t_r | – | 85 | 160 | ns |
| Output voltage fall time (from 90% to 10% @ $V_{CC} = 15\text{ V}$) with 1 nF load | t_f | – | 35 | 75 | ns |
| Propagation delay matching between the High side and the Low side @ 25°C (Note 3) | Δt | – | 20 | 35 | ns |
| Internal fixed dead time (only valid for B version) (Note 4) | DT | 65 | 100 | 190 | ns |
| Minimum input width that changes the output | t_{PW1} | – | – | 50 | ns |
| Maximum input width that does not change the output | t_{PW2} | 20 15 | – – | – – | ns |

INPUT SECTION

| | | | | | |
|---|-----------|-----|-----|-----|---------------|
| Low level input voltage threshold | V_{IN} | – | – | 0.8 | V |
| Input pull-down resistor ($V_{IN} < 0.5\text{ V}$) | R_{IN} | – | 200 | – | k Ω |
| High level input voltage threshold | V_{IN} | 2.3 | – | – | V |
| Logic “1” input bias current @ $V_{IN_XX} = 5\text{ V}$ @ 25°C | I_{IN+} | – | 5 | 25 | μA |
| Logic “0” input bias current @ $V_{IN_XX} = 0\text{ V}$ @ 25°C | I_{IN-} | – | – | 2.0 | μA |

SUPPLY SECTION

| | | | | | |
|--|--------------------|-----|-----|-----|---------------|
| V_{CC} UV Start-up voltage threshold | V_{CC_stup} | 8.0 | 8.9 | 9.9 | V |
| V_{CC} UV Shut-down voltage threshold | V_{CC_shtdwn} | 7.3 | 8.2 | 9.1 | V |
| Hysteresis on V_{CC} | V_{CC_hyst} | 0.3 | 0.7 | – | V |
| Vboot Start-up voltage threshold reference to bridge pin ($V_{boot_stup} = V_{boot} - V_{bridge}$) | V_{boot_stup} | 8.0 | 8.9 | 9.9 | V |
| Vboot UV Shut-down voltage threshold | V_{boot_shtdwn} | 7.3 | 8.2 | 9.1 | V |
| Hysteresis on Vboot | V_{boot_hyst} | 0.3 | 0.7 | – | V |
| Leakage current on high voltage pins to GND ($V_{BOOT} = V_{BRIDGE} = DRV_HI = 200\text{ V}$) | I_{HV_LEAK} | – | 5 | 40 | μA |
| Consumption in active mode ($V_{CC} = V_{boot}$, $f_{sw} = 100\text{ kHz}$ and 1 nF load on both driver outputs) | ICC1 | – | 4 | 5 | mA |
| Consumption in inhibition mode ($V_{CC} = V_{boot}$) | ICC2 | – | 250 | 400 | μA |
| V_{CC} current consumption in inhibition mode | ICC3 | – | 200 | – | μA |
| Vboot current consumption in inhibition mode | ICC4 | – | 50 | – | μA |

Product parametric performance is indicated in the Electrical Characteristics for the listed test conditions, unless otherwise noted. Product performance may not be indicated by the Electrical Characteristics if operated under different conditions.

1. Parameter guaranteed by design.
2. Turn-off propagation delay @ $V_{bridge} = 200\text{ V}$ is guaranteed by design.
3. See characterization curve for Δt parameters variation on the full range temperature.
4. Version B integrates a dead time in order to prevent any cross conduction between DRV_HI and DRV_LO . See timing diagram of Figure 10.
5. Timing diagram definition see: Figure 7, Figure 8 and Figure 9.

NCP5109A, NCP5109B

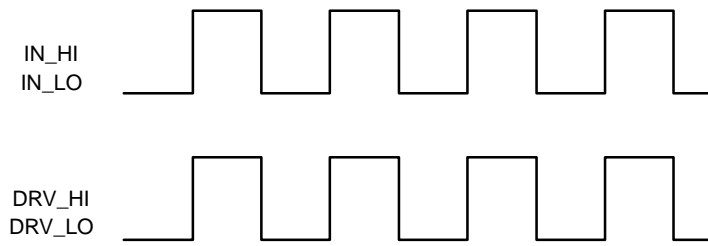

Figure 5. Input/Output Timing Diagram (A Version)

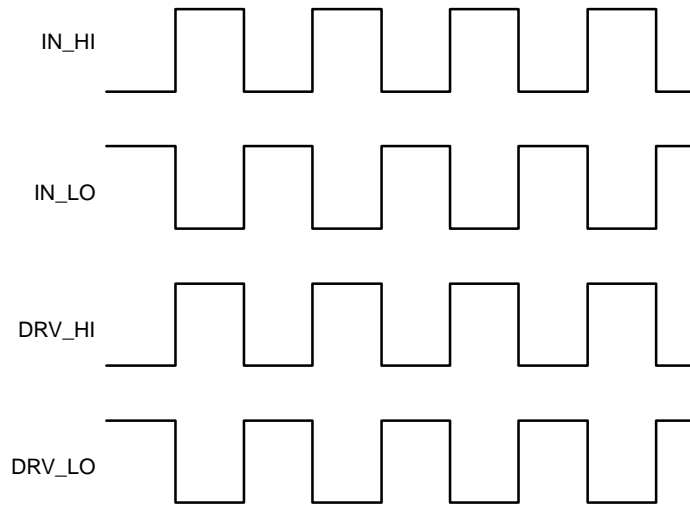

Figure 6. Input/Output Timing Diagram (B Version)

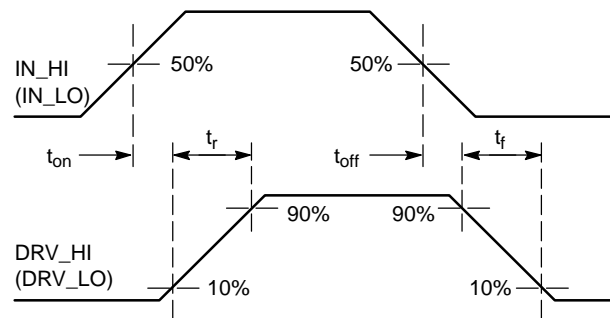

Figure 7. Propagation Delay and Rise / Fall Time Definition

NCP5109A, NCP5109B

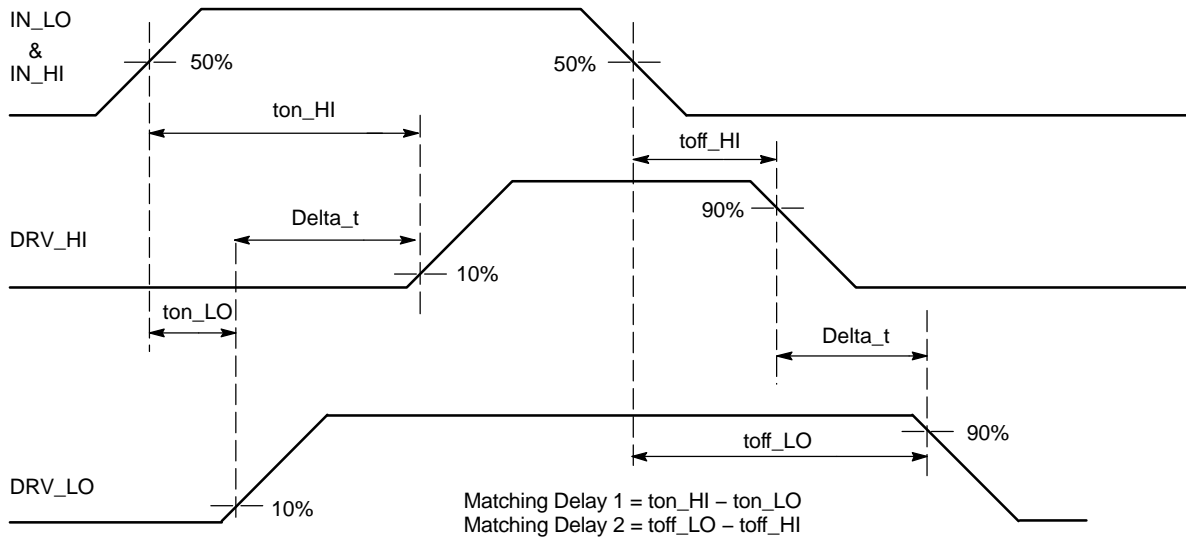

Figure 8. Matching Propagation Delay (A Version)

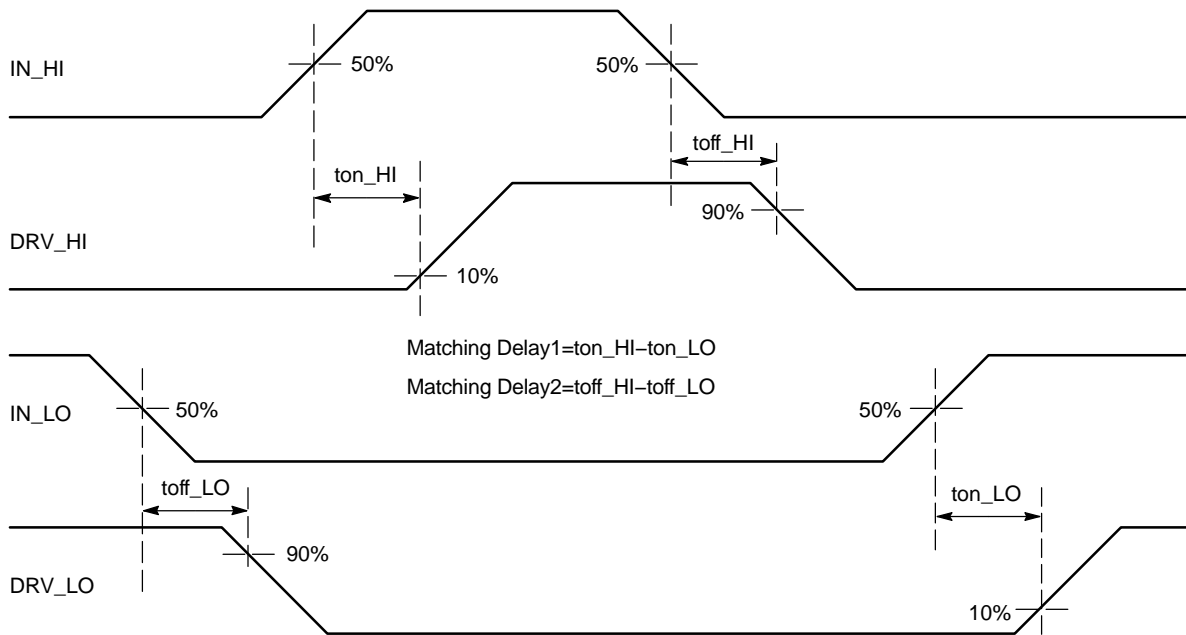

Figure 9. Matching Propagation Delay (B Version)

NCP5109A, NCP5109B

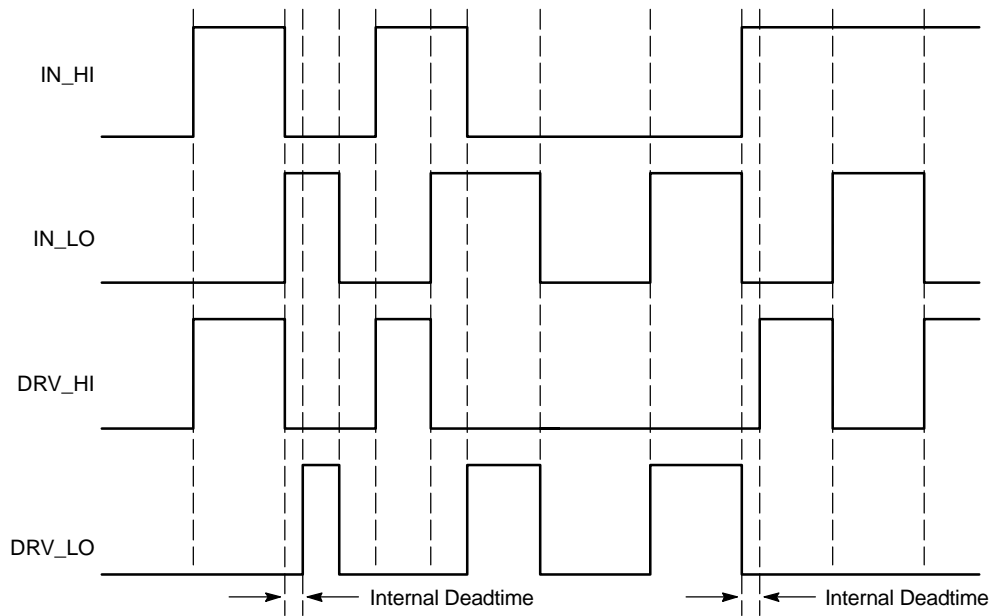

Figure 10. Input/Output Cross Conduction Output Protection Timing Diagram (B Version)

NCP5109A, NCP5109B

CHARACTERIZATION CURVES

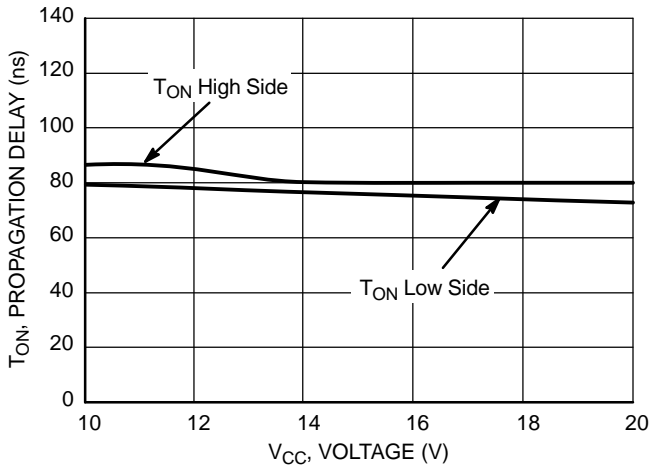

Figure 11. Turn ON Propagation Delay vs. Supply Voltage ($V_{CC} = V_{BOOT}$)

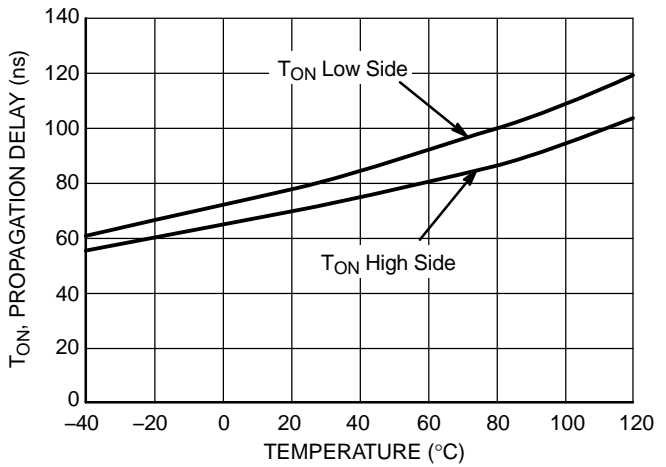

Figure 12. Turn ON Propagation Delay vs. Temperature

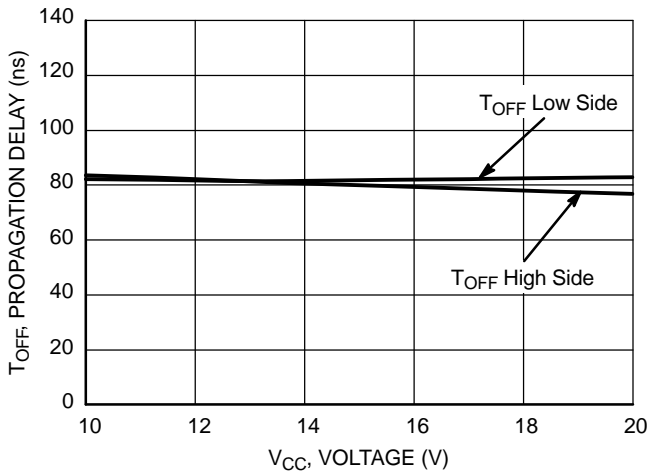

Figure 13. Turn OFF Propagation Delay vs. Supply Voltage ($V_{CC} = V_{BOOT}$)

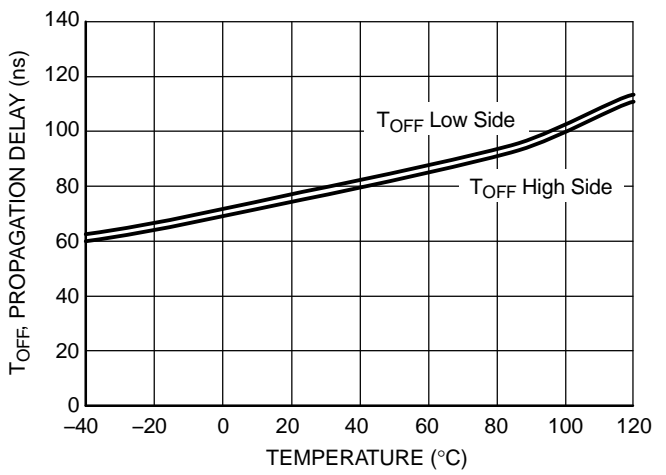

Figure 14. Turn OFF Propagation Delay vs. Temperature

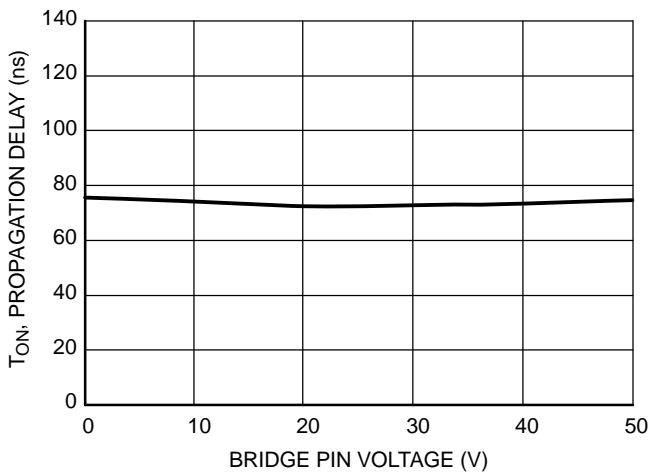

Figure 15. High Side Turn ON Propagation Delay vs. V_{BRIDGE} Voltage

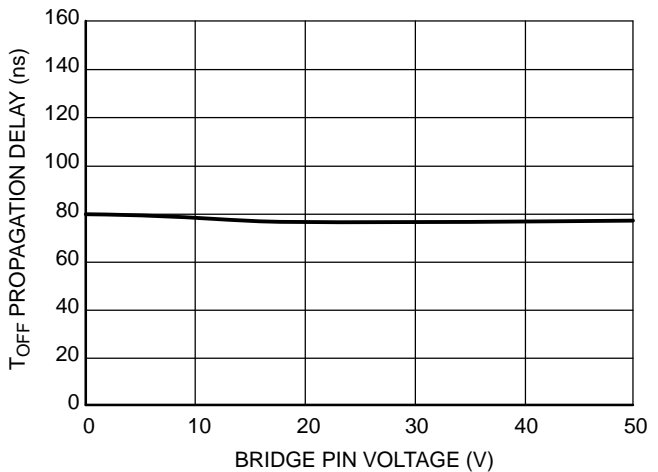

Figure 16. High Side Turn OFF Propagation Delay vs. V_{BRIDGE} Voltage

NCP5109A, NCP5109B

CHARACTERIZATION CURVES

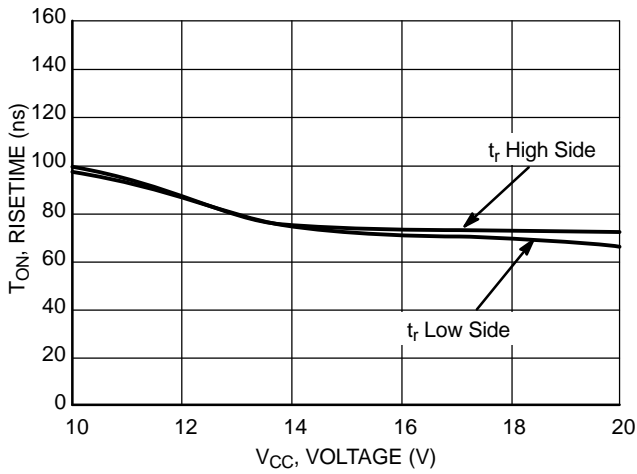

Figure 17. Turn ON Risetime vs. Supply Voltage ($V_{CC} = V_{BOOT}$)

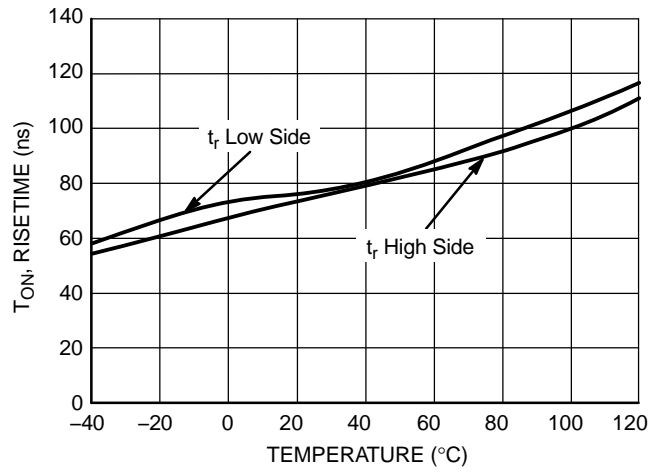

Figure 18. Turn ON Risetime vs. Temperature

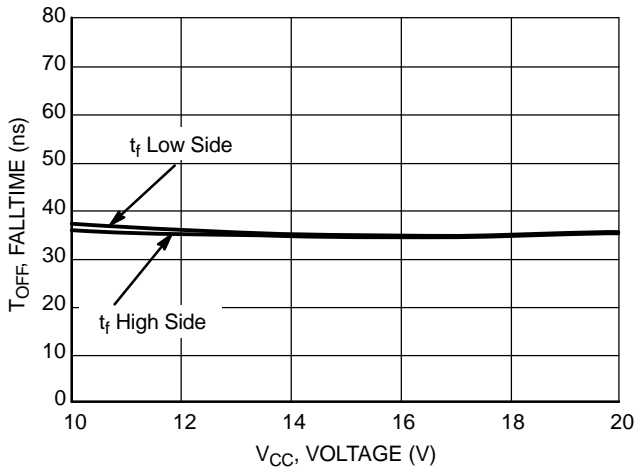

Figure 19. Turn OFF Falltime vs. Supply Voltage ($V_{CC} = V_{BOOT}$)

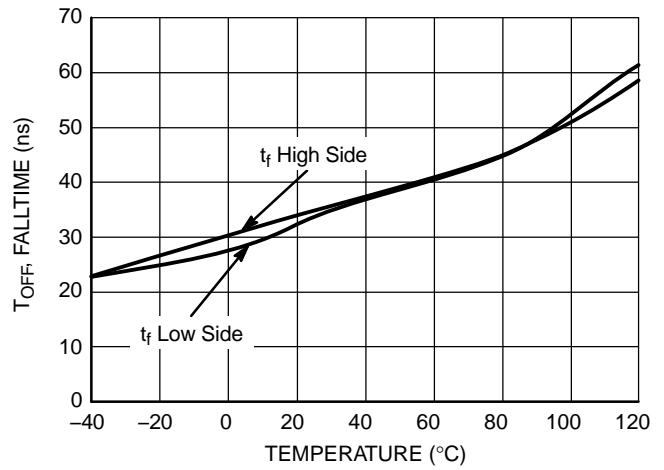

Figure 20. Turn OFF Falltime vs. Temperature

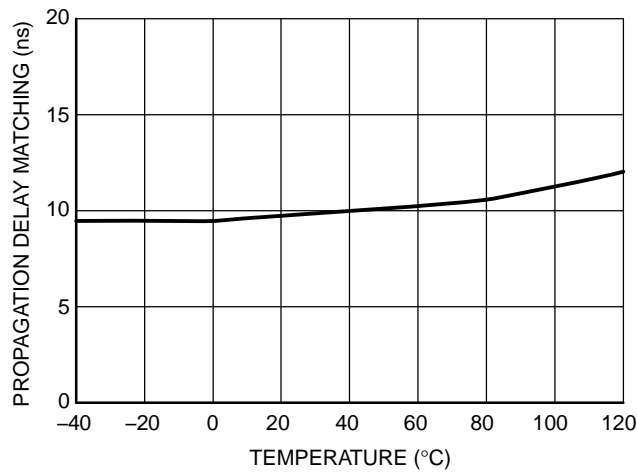

Figure 21. Propagation Delay Matching Between High Side and Low Side Driver vs. Temperature

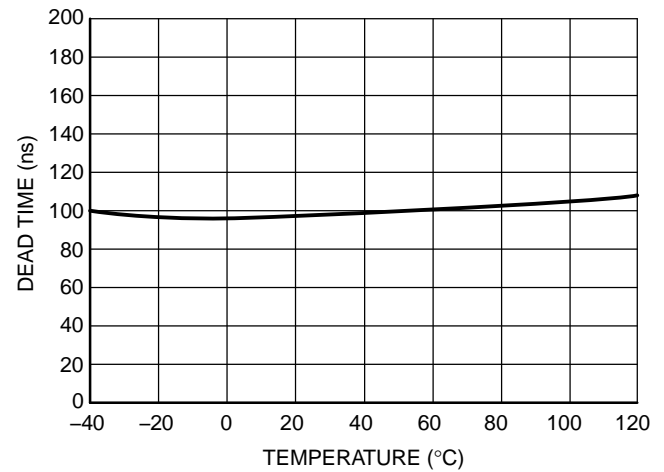

Figure 22. Dead Time vs. Temperature

NCP5109A, NCP5109B

CHARACTERIZATION CURVES

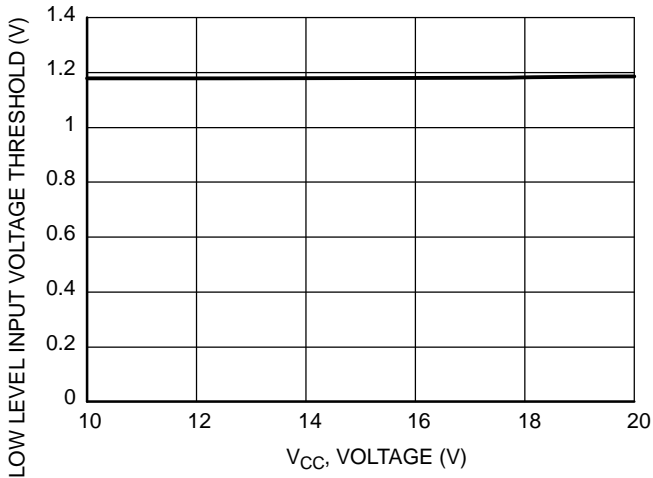

Figure 23. Low Level Input Voltage Threshold vs. Supply Voltage ($V_{CC} = V_{BOOT}$)

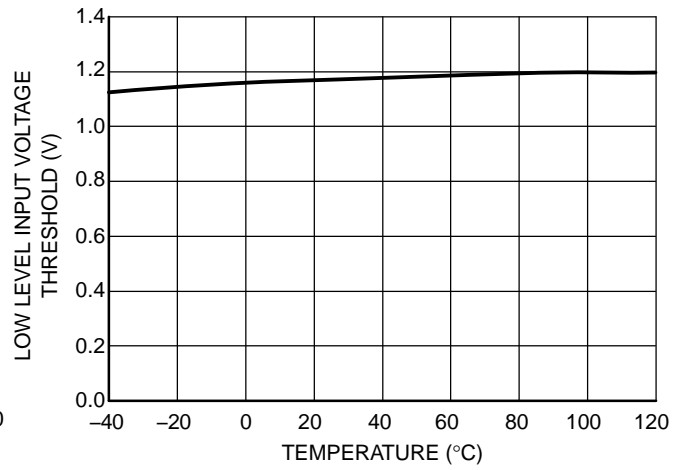

Figure 24. Low Level Input Voltage Threshold vs. Temperature

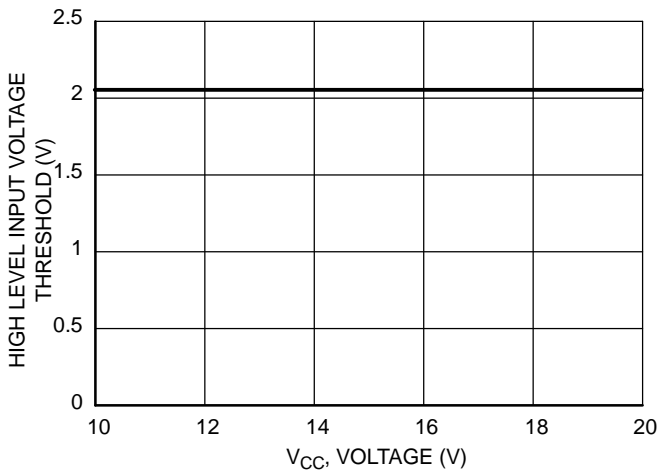

Figure 25. High Level Input Voltage Threshold vs. Supply Voltage ($V_{CC} = V_{BOOT}$)

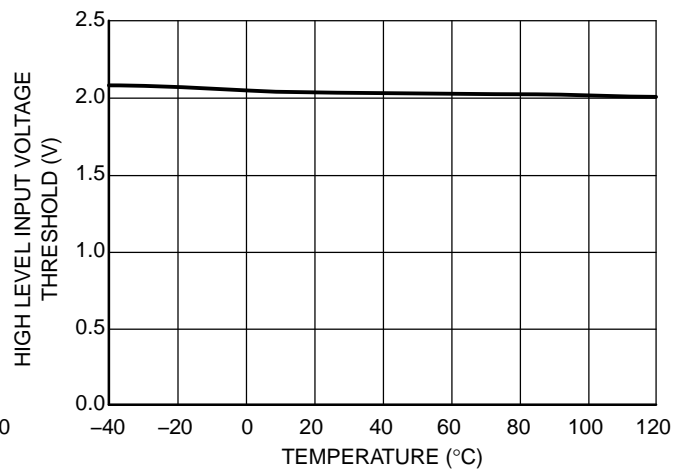

Figure 26. High Level Input Voltage Threshold vs. Temperature

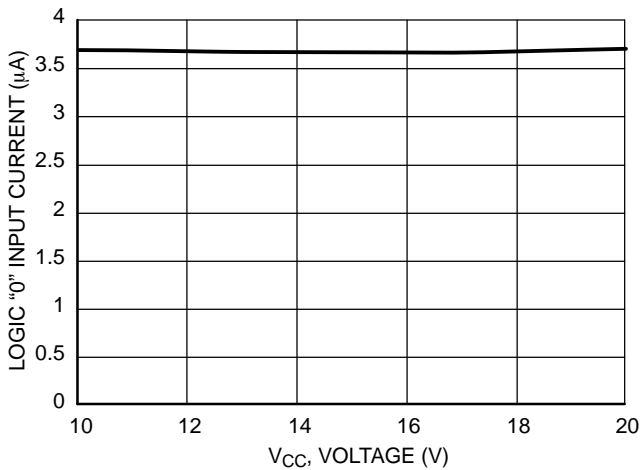

Figure 27. Logic "0" Input Current vs. Supply Voltage ($V_{CC} = V_{BOOT}$)

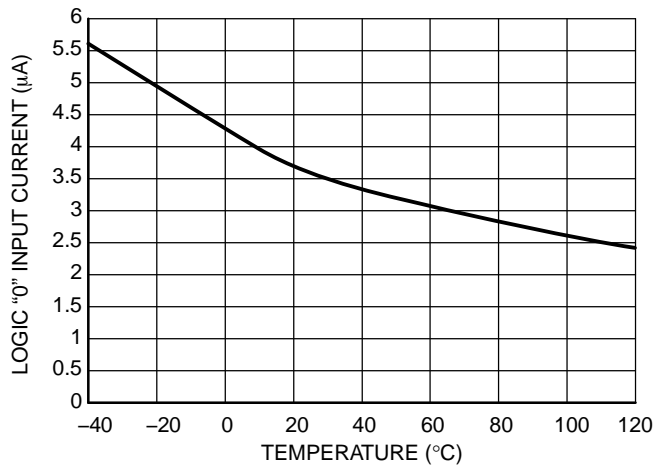

Figure 28. Logic "0" Input Current vs. Temperature

NCP5109A, NCP5109B

CHARACTERIZATION CURVES

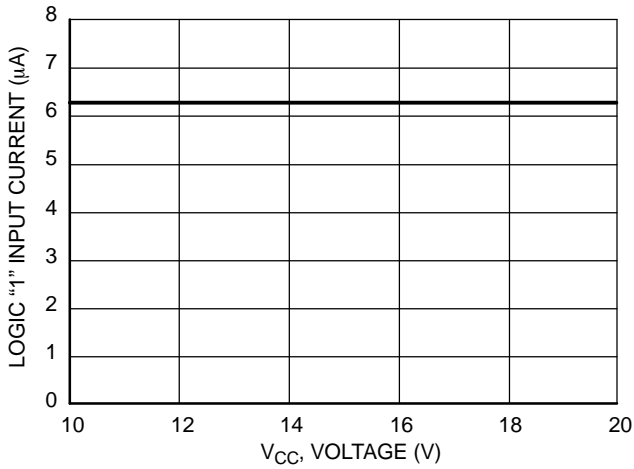

Figure 29. Logic "1" Input Current vs. Supply Voltage ($V_{CC} = V_{BOOT}$)

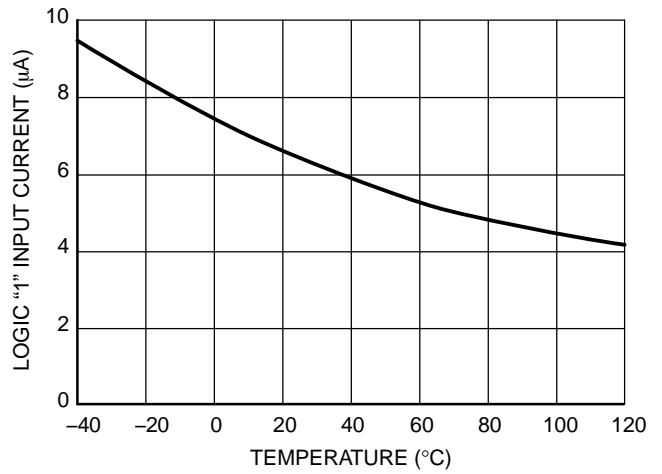

Figure 30. Logic "1" Input Current vs. Temperature

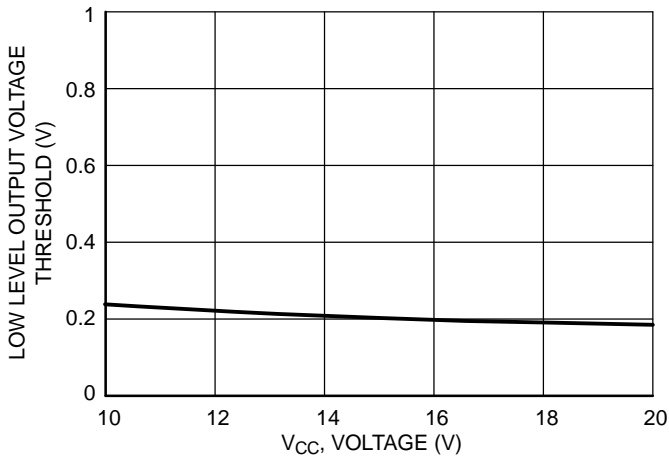

Figure 31. Low Level Output Voltage vs. Supply Voltage ($V_{CC} = V_{BOOT}$)

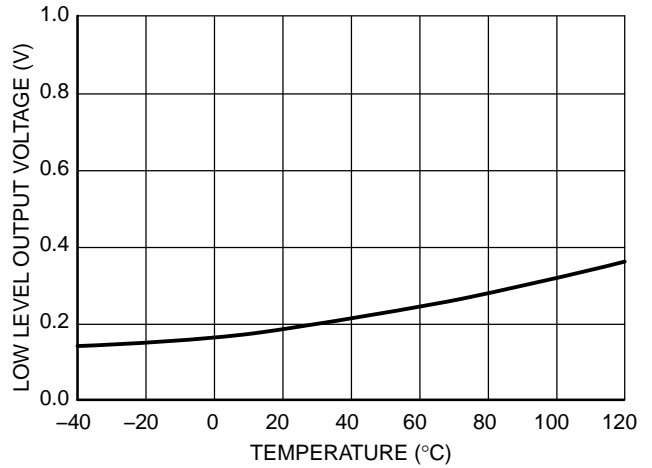

Figure 32. Low Level Output Voltage vs. Temperature

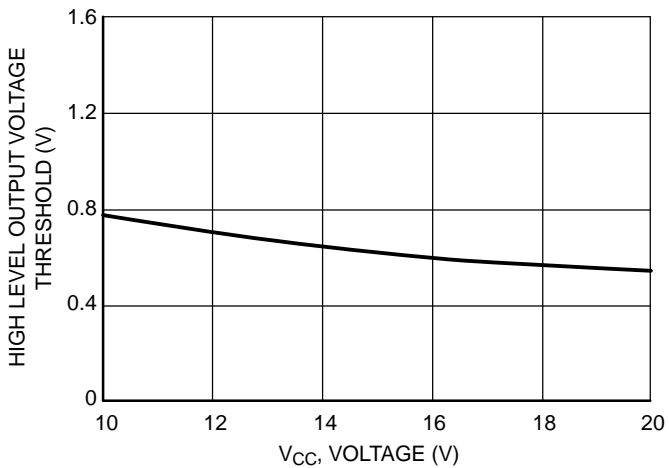

Figure 33. High Level Output Voltage vs. Supply Voltage ($V_{CC} = V_{BOOT}$)

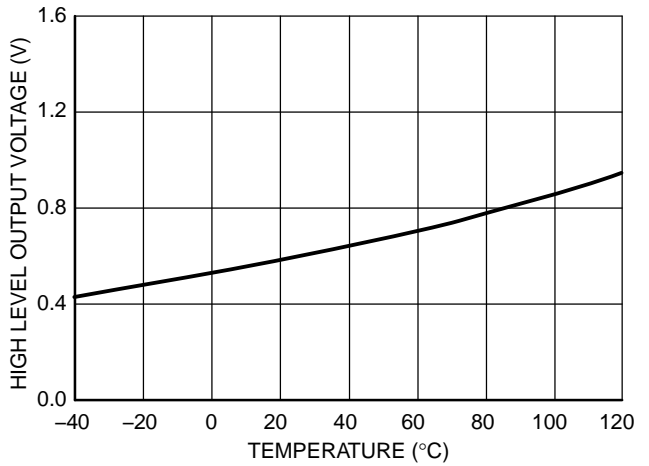

Figure 34. High Level Output Voltage vs. Temperature

NCP5109A, NCP5109B

CHARACTERIZATION CURVES

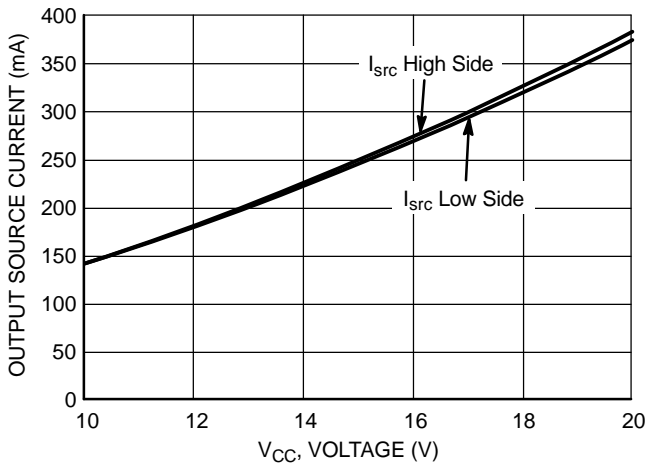

Figure 35. Output Source Current vs. Supply Voltage ($V_{CC} = V_{BOOT}$)

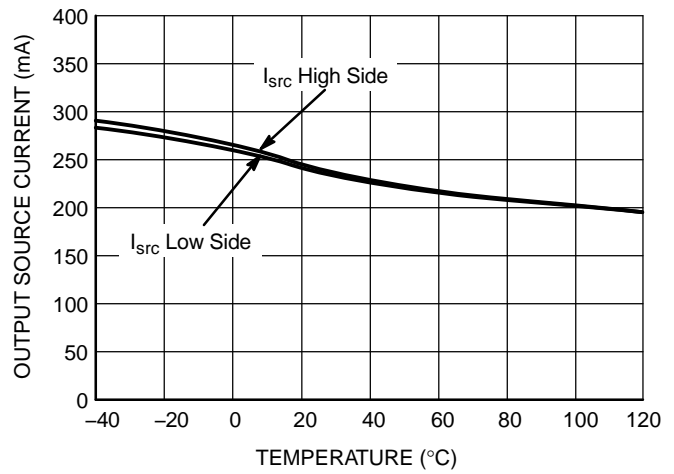

Figure 36. Output Source Current vs. Temperature

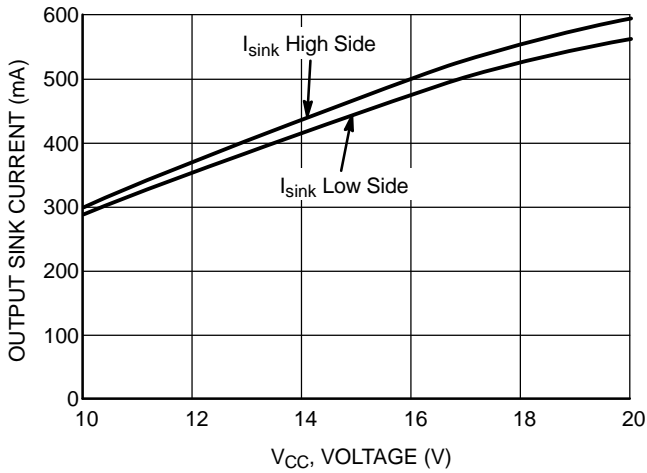

Figure 37. Output Sink Current vs. Supply Voltage ($V_{CC} = V_{BOOT}$)

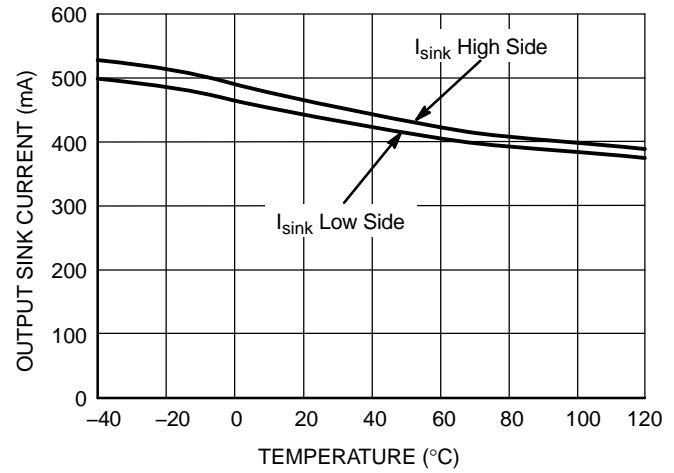

Figure 38. Output Sink Current vs. Temperature

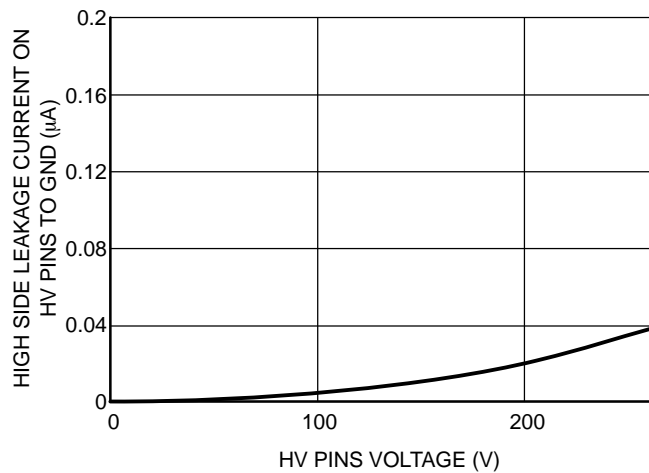

Figure 39. Leakage Current on High Voltage Pins (200 V) to Ground vs. V_{BRIDGE} Voltage ($V_{BRIDGE} = V_{BOOT} = V_{DRV_HI}$)

NCP5109A, NCP5109B

CHARACTERIZATION CURVES

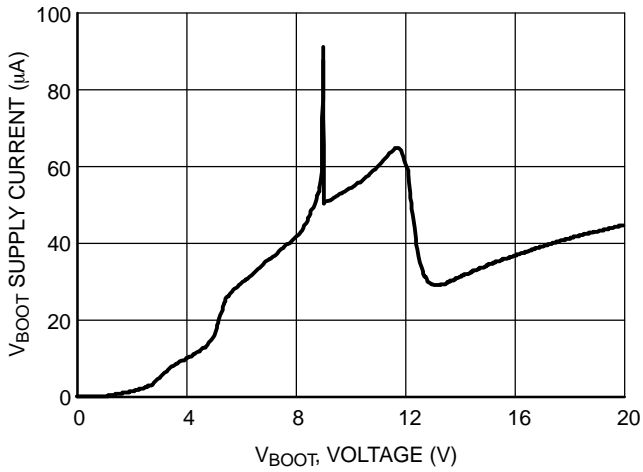

Figure 40. V_{BOOT} Supply Current vs. Bootstrap Supply Voltage

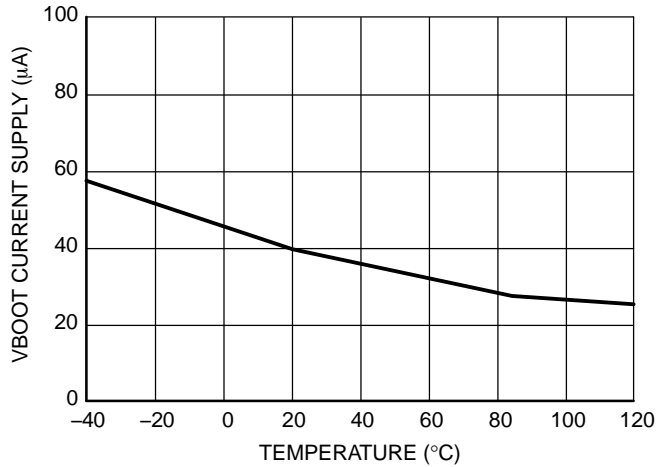

Figure 41. V_{BOOT} Supply Current vs. Temperature

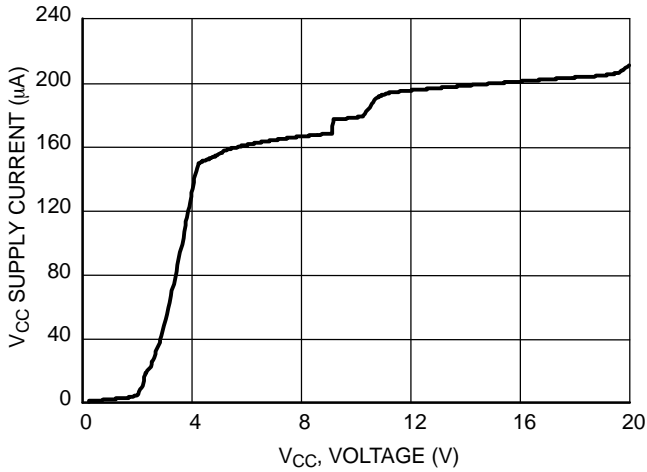

Figure 42. V_{CC} Supply Current vs. V_{CC} Supply Voltage

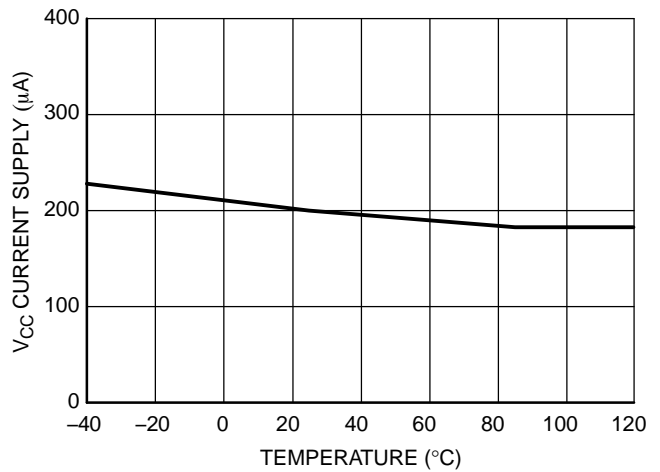

Figure 43. V_{CC} Supply Current vs. Temperature

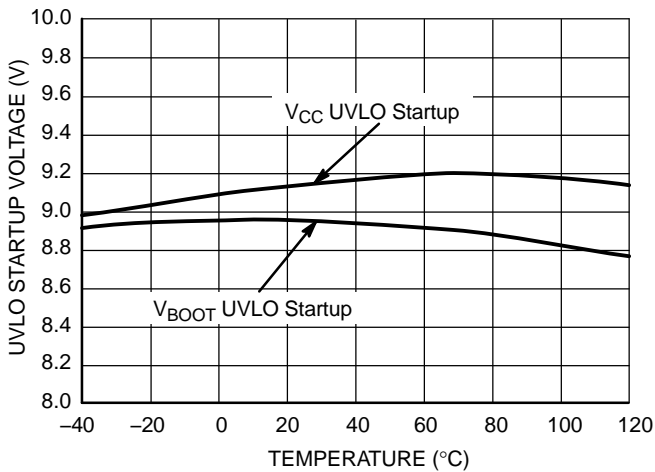

Figure 44. UVLO Startup Voltage vs. Temperature

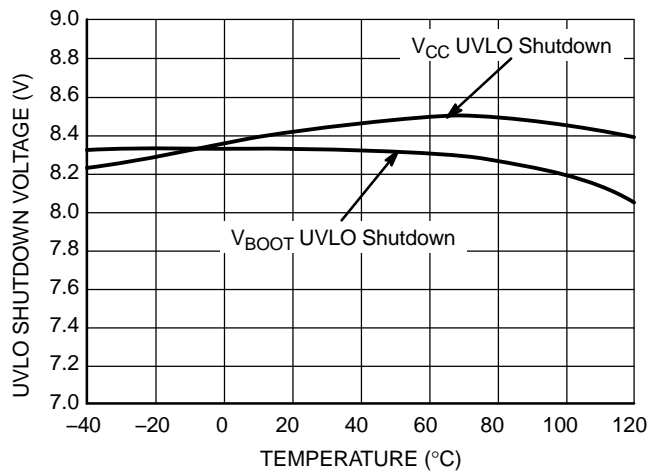

Figure 45. UVLO Shutdown Voltage vs. Temperature

NCP5109A, NCP5109B

CHARACTERIZATION CURVES

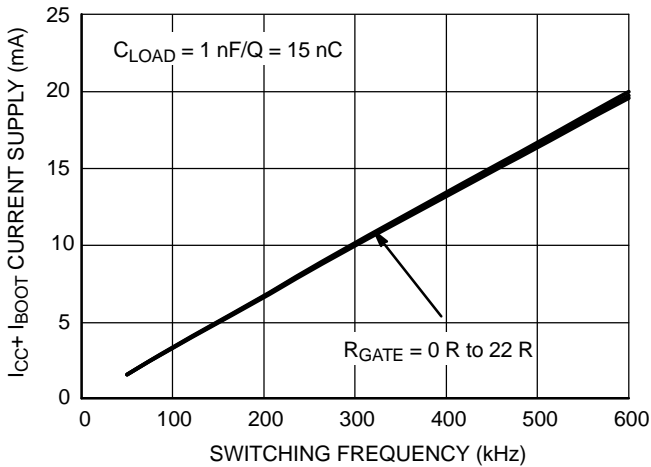

Figure 46. I_{CC1} Consumption vs. Switching Frequency with 15 nC Load on Each Driver @ $V_{CC} = 15\text{ V}$

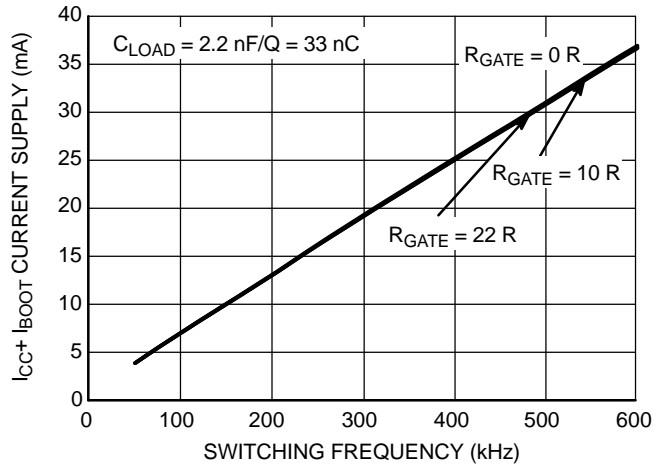

Figure 47. I_{CC1} Consumption vs. Switching Frequency with 33 nC Load on Each Driver @ $V_{CC} = 15\text{ V}$

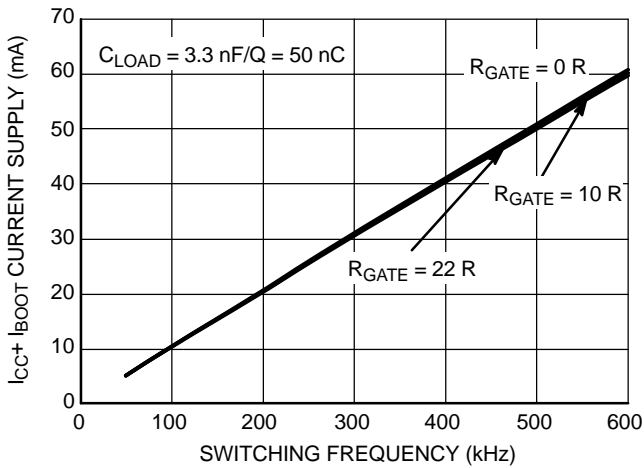

Figure 48. I_{CC1} Consumption vs. Switching Frequency with 50 nC Load on Each Driver @ $V_{CC} = 15\text{ V}$

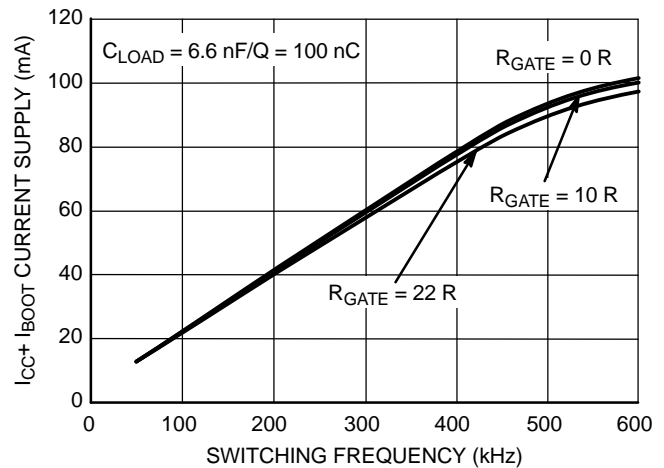

Figure 49. I_{CC1} Consumption vs. Switching Frequency with 100 nC Load on Each Driver @ $V_{CC} = 15\text{ V}$

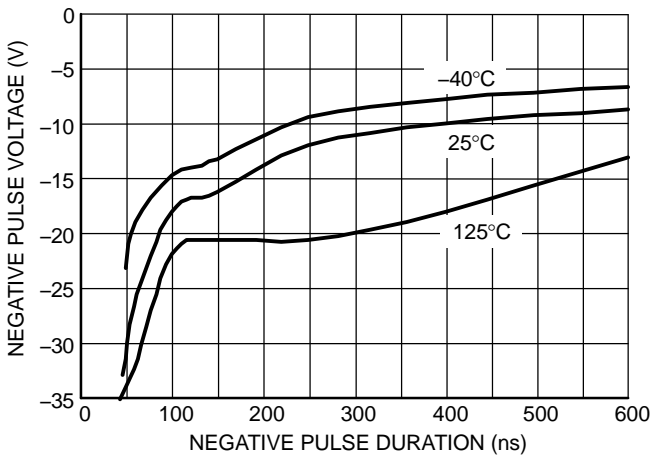

Figure 50. NCP5109A, Negative Voltage Safe Operating Area on the Bridge Pin

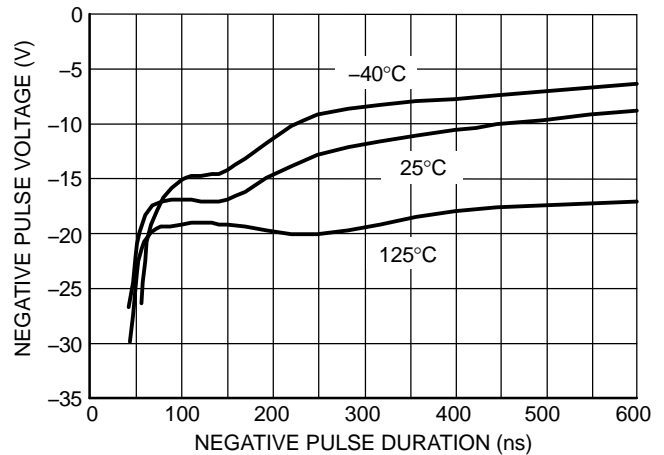

Figure 51. NCP5109B, Negative Voltage Safe Operating Area on the Bridge Pin

NCP5109A, NCP5109B

APPLICATION INFORMATION

Negative Voltage Safe Operating Area

When the driver is used in a half bridge configuration, it is possible to see negative voltage appearing on the bridge pin (pin 6) during the power MOSFETs transitions. When the high-side MOSFET is switched off, the body diode of the low-side MOSFET starts to conduct. The negative voltage applied to the bridge pin thus corresponds to the forward voltage of the body diode. However, as pcb copper tracks and wire bonding introduce stray elements (inductance and capacitor), the maximum negative voltage of the bridge pin will combine the forward voltage and the oscillations created by the parasitic elements. As any CMOS device, the deep negative voltage of a selected pin can inject carriers into the substrate, leading to an erratic behavior of the concerned component. ON Semiconductor provides characterization data of its half-bridge driver to show the maximum negative voltage the driver can safely operate with. To prevent the negative injection, it is the designer duty to verify that the amount of negative voltage pertinent to his/her application does not exceed the characterization curve we provide, including some safety margin.

In order to estimate the maximum negative voltage accepted by the driver, this parameter has been characterized over full the temperature range of the component. A test fixture has been developed in which we purposely negatively bias the bridge pin during the freewheel period of a buck converter. When the upper gate voltage shows signs of an erratic behavior, we consider the limit has been reached.

Figure 50 (or 51), illustrates the negative voltage safe operating area. Its interpretation is as follows: assume a negative 10 V pulse featuring a 100 ns width is applied on the bridge pin, the driver will work correctly over the whole die temperature range. Should the pulse swing to -20 V, keeping the same width of 100 ns, the driver will not work properly or will be damaged for temperatures below 125°C.

Summary:

- If the negative pulse characteristic (negative voltage level & pulse width) is above the curves the driver runs in safe operating area.
- If the negative pulse characteristic (negative voltage level & pulse width) is below one or all curves the driver will NOT run in safe operating area.

Note, each curve of the Figure 50 (or 51) represents the negative voltage and width level where the driver starts to fail at the corresponding die temperature.

If in the application the bridge pin is too close of the safe operating limit, it is possible to limit the negative voltage to the bridge pin by inserting one resistor and one diode as follows:

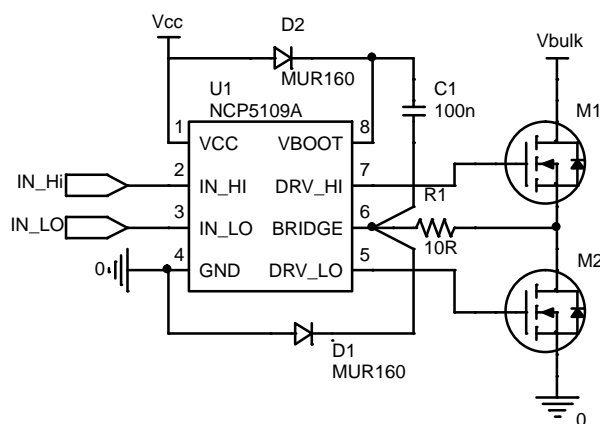

Figure 52. R1 and D1 Improves the Robustness of the Driver

R1 and D1 should be placed as close as possible of the driver. D1 should be connected directly between the bridge pin (pin 6) and the ground pin (pin 4). By this way the negative voltage applied to the bridge pin will be limited by D1 and R1 and will prevent any wrong behavior.

ORDERING INFORMATION

| Device | Package | Shipping† |
|---------------|------------------|--------------------|
| NCP5109ADR2G | SOIC-8 (Pb-Free) | 2500 / Tape & Reel |
| NCP5109BDR2G | SOIC-8 (Pb-Free) | 2500 / Tape & Reel |
| NCP5109AMNTWG | DFN10 (Pb-Free) | 3000 / Tape & Reel |
| NCP5109BMNTWG | DFN10 (Pb-Free) | 3000 / Tape & Reel |

†For information on tape and reel specifications, including part orientation and tape sizes, please refer to our Tape and Reel Packaging Specifications Brochure, BRD8011/D.

NCP5109A, NCP5109B

PACKAGE DIMENSIONS

SOIC-8 NB
CASE 751-07
ISSUE AK

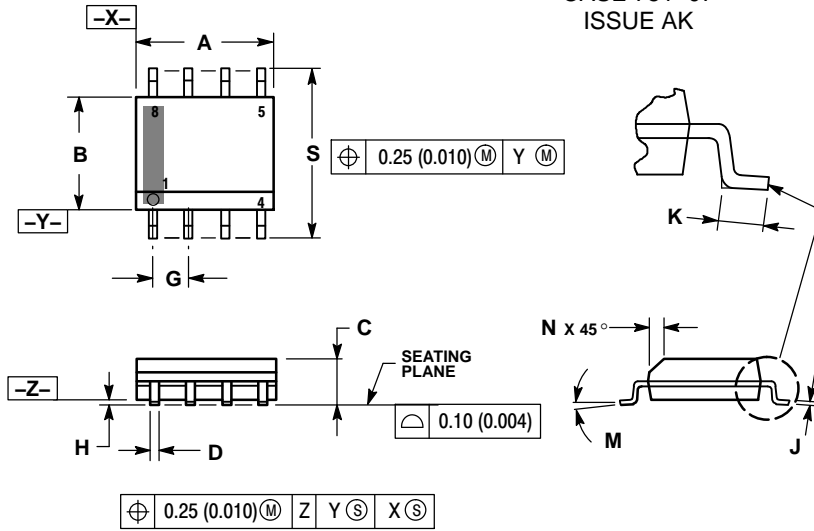

NOTES:

1. DIMENSIONING AND TOLERANCING PER ANSI Y14.5M, 1982.
2. CONTROLLING DIMENSION: MILLIMETER.
3. DIMENSION A AND B DO NOT INCLUDE MOLD PROTRUSION.
4. MAXIMUM MOLD PROTRUSION 0.15 (0.006) PER SIDE.
5. DIMENSION D DOES NOT INCLUDE DAMBAR PROTRUSION. ALLOWABLE DAMBAR PROTRUSION SHALL BE 0.127 (0.005) TOTAL IN EXCESS OF THE D DIMENSION AT MAXIMUM MATERIAL CONDITION.
6. 751-01 THRU 751-06 ARE OBSOLETE. NEW STANDARD IS 751-07.

| DIM | MILLIMETERS | | INCHES | |
|-----|-------------|------|-----------|-------|
| | MIN | MAX | MIN | MAX |
| A | 4.80 | 5.00 | 0.189 | 0.197 |
| B | 3.80 | 4.00 | 0.150 | 0.157 |
| C | 1.35 | 1.75 | 0.053 | 0.069 |
| D | 0.33 | 0.51 | 0.013 | 0.020 |
| G | 1.27 BSC | | 0.050 BSC | |
| H | 0.10 | 0.25 | 0.004 | 0.010 |
| J | 0.19 | 0.25 | 0.007 | 0.010 |
| K | 0.40 | 1.27 | 0.016 | 0.050 |
| M | 0° | 8° | 0° | 8° |
| N | 0.25 | 0.50 | 0.010 | 0.020 |
| S | 5.80 | 6.20 | 0.228 | 0.244 |

SOLDERING FOOTPRINT*

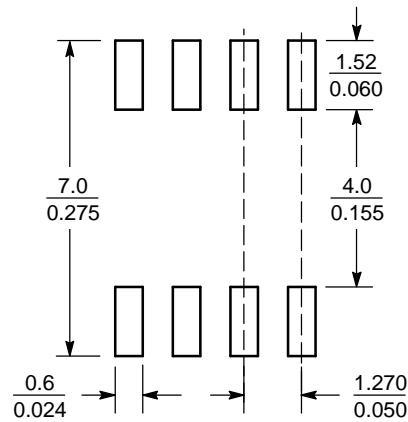

SCALE 6:1 $\left(\frac{\text{mm}}{\text{inches}}\right)$

*For additional information on our Pb-Free strategy and soldering details, please download the ON Semiconductor Soldering and Mounting Techniques Reference Manual, SOLDERRM/D.

Looking for pricing, stock, or lifecycle information?

Click below to explore more details on WIN SOURCE:

- ⊖ [View NCP5109ADR2G on WIN SOURCE](#)
- ⊖ [ON Semiconductor Information](#)

Optimize Your Supply Chain with WIN SOURCE Solutions

- ✓ Global Sourcing Solution
- ✓ Obsolete Management
- ✓ Cost Control Management
- ✓ Shortage Management
- ✓ Alternative Solution
- ✓ Excess Inventory Management