



THE DATASHEET OF B3J-2100



Hinged Tactile Switch

B3J

Through-hole-mounting Switches with Hinges for a Sharp Snap Action

- Quick, superior snap action through hook-type hinge construction.
- Available with 1 or 2 LEDs or without LEDs.
- The hinge button is available in a wide variety of colors (five standard colors).

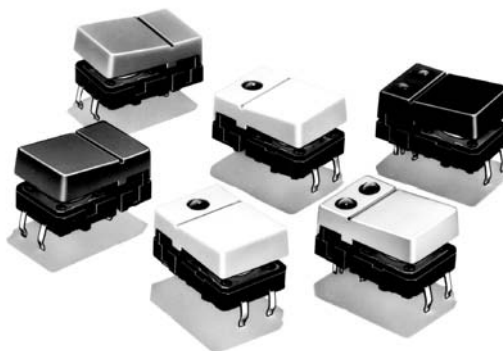

RoHS Compliant

■ List of Models

Operation type	Contact material	Operating force (OF)	Color of hinged button	Box	
				Model	Minimum packing unit
Non-lighted: B3J-1000 Series	Silver plated	1.27 N {130 gf}	Ivory	B3J-1000	300 pcs
			Black	B3J-1100	
			Orange	B3J-1200	
			Yellow	B3J-1300	
			Blue	B3J-1400	

Operation type	Contact material	Operating force (OF)	Color of hinged button	Box			Minimum packing unit
				LED color			
				Red	Yellow	Green	
One LED: B3J-2000 Series B3J-3000 Series B3J-4000 Series	Silver plated	1.27 N {130 gf}	Ivory	B3J-2000	B3J-3000	B3J-4000	300 pcs
			Black	B3J-2100	B3J-3100	B3J-4100	
			Orange	B3J-2200	B3J-3200	B3J-4200	
			Yellow	B3J-2300	B3J-3300	B3J-4300	
			Blue	B3J-2400	B3J-3400	B3J-4400	

Operation type	Contact material	Operating force (OF)	Color of hinged button	Box			Minimum packing unit
				LED color			
				Red/Yellow	Red/Green	Yellow/Green	
Two LEDs: B3J-5000 Series B3J-6000 Series B3J-7000 Series	Silver plated	1.27 N {130 gf}	Ivory	B3J-5000	B3J-6000	B3J-7000	300 pcs
			Black	B3J-5100	B3J-6100	B3J-7100	
			Orange	B3J-5200	B3J-6200	B3J-7200	
			Yellow	B3J-5300	B3J-6300	B3J-7300	
			Blue	B3J-5400	B3J-6400	B3J-7400	

■ Ratings/Characteristics

Rating (resistive load)	1 to 50 mA, 3 to 24 VDC
Minimum applicable load (reference value)	10 μ A at 1 VDC (resistive load)
Ambient operating temperature	-25°C to +70°C at 60%RH max. (with no icing or condensation)
Ambient operating humidity	35% to 85% (at +5 to +35°C)
Contact form	SPST-NO
Contact resistance (initial value)	100 m Ω max.
Insulation resistance	100 M Ω min. (at 250 VDC with insulation tester)
Dielectric strength	500 VAC, 50/60 Hz for 1 min
Bounce time	5 ms max.
Vibration resistance	Malfunction: 10 to 55 Hz, 1.5-mm double amplitude
Shock resistance	Destruction: 1,000 m/s ² {approx. 100G} max. Malfunction: 100 m/s ² {approx. 10G} max.
Durability	3,000,000 operations min.
Weight	Approx. 1.5 to 1.7 g
Degree of protection	IEC IP00
Washing	Not possible

■ Operating Characteristics

Operating force (OF)	1.27 \pm 0.49 N {130 \pm 50 gf}
Releasing force (RF)	0.29 N {30 gf} min.
Pretravel (PT)	0.3 ^{+0.2} / _{-0.1} mm

■ LED Specifications

Item		Red	Yellow	Green
Forward voltage VF	Standard value (V)	2.0	2.0	2.1
Forward current IF	Standard value (mA)	20	20	20
Permissible loss P	Absolute maximum value (mW)	84	84	84
Reverse voltage VR	Absolute maximum value (V)	5	5	5

Note: Since the built-in LED does not contain any limiting resistors, externally connect limiting resistors within the limits shown in the above table.

■ Dimensions (Unit: mm)

Types with no LED

B3J-1□00

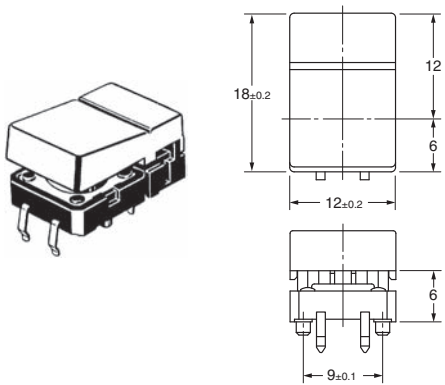

PCB Processing Dimensions (Reference Only) (Top View)

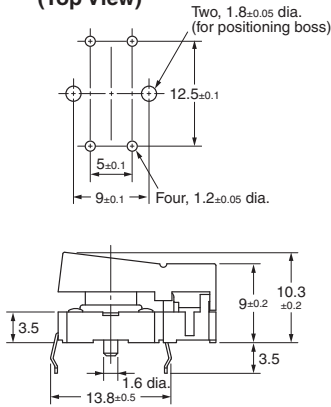

Panel Cutout Terminal Arrangement /Internal Connections (Top View)

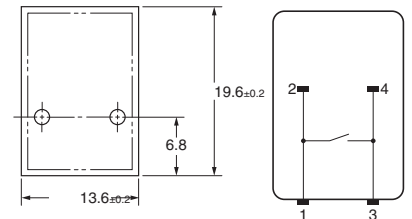

1 LED Types

B3J-2□00

B3J-3□00

B3J-4□00

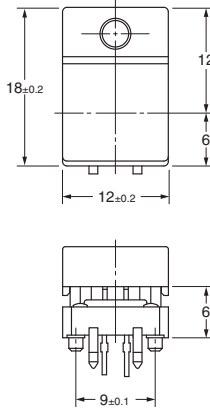
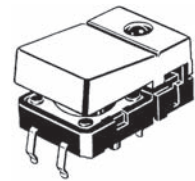

PCB Processing Dimensions (Reference Only) (Top View)

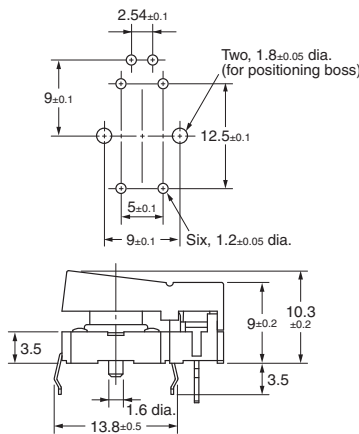

Panel Cutout Terminal Arrangement /Internal Connections (Top View)

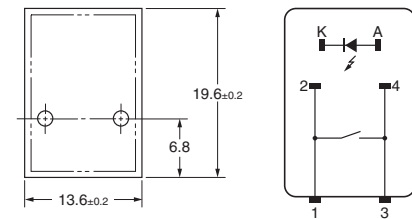

2 LED Types

B3J-5□00

B3J-6□00

B3J-7□00

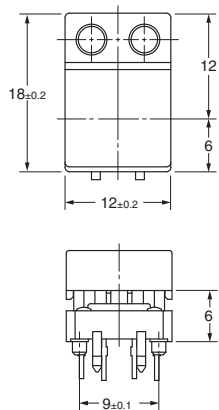
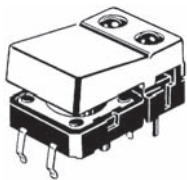

PCB Processing Dimensions (Reference Only) (Top View)

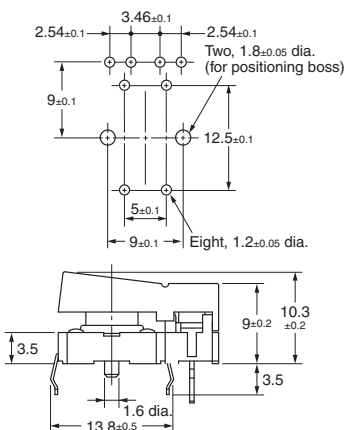

Panel Cutout Terminal Arrangement /Internal Connections (Top View)

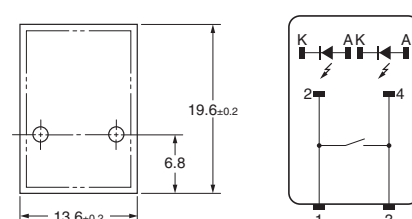

Note: Unless otherwise specified, a tolerance of ±0.4 mm applies to all dimensions.

■ Precautions

Be sure to read the safety precautions common to all Tactile Switches for correct use.

- Application examples provided in this document are for reference only. In actual applications, confirm equipment functions and safety before using the product.
- Consult your OMRON representative before using the product under conditions which are not described in the manual or applying the product to nuclear control systems, railroad systems, aviation systems, vehicles, combustion systems, medical equipment, amusement machines, safety equipment, and other systems or equipment that may have a serious influence on lives and property if used improperly. Make sure that the ratings and performance characteristics of the product provide a margin of safety for the system or equipment, and be sure to provide the system or equipment with double safety mechanisms.

Note: Do not use this document to operate the Unit.

OMRON Corporation
Electronic and Mechanical Components Company

Contact: www.omron.com/ecb

Cat. No. A071-E1-07
1014(0207)(O)

Looking for pricing, stock, or lifecycle information?

Click below to explore more details on WIN SOURCE:

 [View B3J-2100 on WIN SOURCE](#)

 [Omron Information](#)

Optimize Your Supply Chain with WIN SOURCE Solutions

-  Global Sourcing Solution
-  Obsolete Management
-  Cost Control Management
-  Shortage Management
-  Alternative Solution
-  Excess Inventory Management