



# THE DATASHEET OF NE521DR2



# NE521

## High-Speed Dual-Differential Comparator/Sense Amp

### Features

- TTL-Compatible Strobes and Outputs
- Large Common-Mode Input Voltage Range
- Operates from Standard Supply Voltages
- Pb-Free Packages are Available

### Applications

- MOS Memory Sense Amp
- A-to-D Conversion
- High-Speed Line Receiver

### MAXIMUM RATINGS

Rating	Symbol	Value	Unit	
Supply Voltage Positive Negative	V+ V-	+7.0 -7.0	V	
Differential Input Voltage	V <sub>IDR</sub>	±6.0	V	
Input Voltage Common Mode Strobe/Gate	V <sub>IN</sub>	±5.0 +5.25	V	
Maximum Power Dissipation (Note 1) T <sub>A</sub> = 25°C (Still-Air)	P <sub>D</sub>	N Package D Package	1420 1040	mW
Thermal Resistance, Junction-to-Ambient N Package D Package	R <sub>θJA</sub>	100 145	°C/W	
Operating Temperature Range	T <sub>A</sub>	0 to 70	°C	
Storage Temperature Range	T <sub>stg</sub>	-65 to +150	°C	
Operating Junction Temperature	T <sub>J</sub>	150	°C	
Lead Soldering Temperature (10 sec max)	T <sub>slid</sub>	+230	°C	

Stresses exceeding Maximum Ratings may damage the device. Maximum Ratings are stress ratings only. Functional operation above the Recommended Operating Conditions is not implied. Extended exposure to stresses above the Recommended Operating Conditions may affect device reliability.

1. Derate above 25°C at the following rates:

- N package at 10 mW/°C
- D package at 6.9 mW/°C.



ON Semiconductor®

<http://onsemi.com>

### MARKING DIAGRAMS

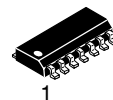

SOIC-14  
D SUFFIX  
CASE 751A

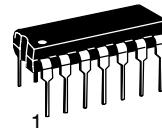

PDIP-14  
N SUFFIX  
CASE 646



A = Assembly Location  
WL = Wafer Lot  
Y, YY = Year  
WW = Work Week  
G = Pb-Free Package

### PIN CONNECTIONS

#### D, N Packages

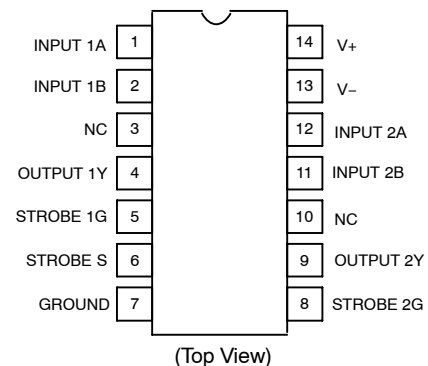

### ORDERING INFORMATION

See detailed ordering and shipping information in the package dimensions section on page 5 of this data sheet.

# NE521

## LOGIC FUNCTION TABLE

$V_{ID} (A^+, B)$	Strobe S	Strobe G	Output (Y)
$V_{ID} \leq -V_{OS}$	H	H	L
$-V_{OS} < V_{ID} < V_{OS}$	H	H	Undefined
$V_{ID} \geq V_{OS}$	H	H	H
X	L	X	H
X	X	L	H

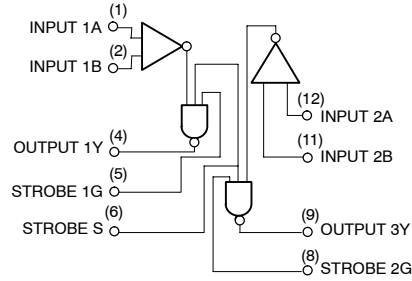

Figure 1. Block Diagram

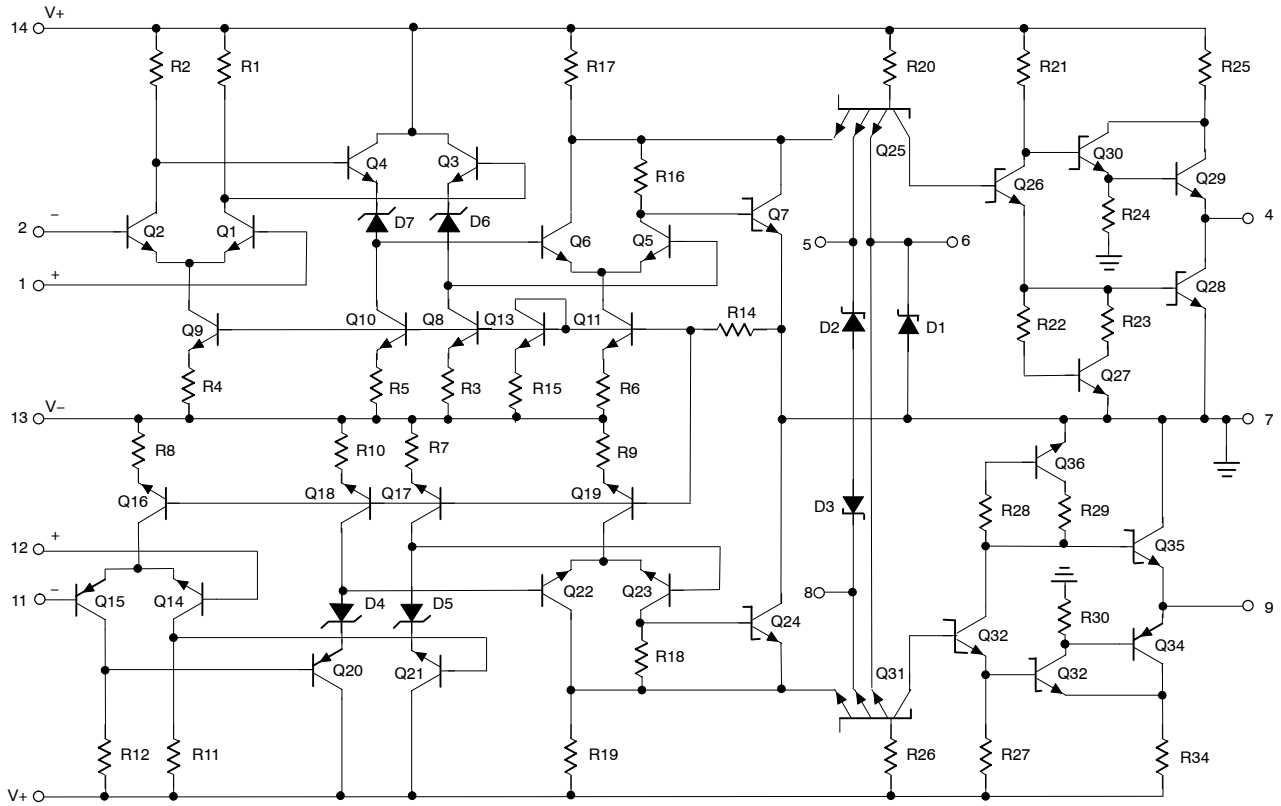

Figure 2. Equivalent Schematic

# NE521

## DC ELECTRICAL CHARACTERISTICS ( $V_+ = +5.0\text{ V}$ ; $V_- = -5.0\text{ V}$ , $T_A = 0^\circ\text{C}$ to $+70^\circ\text{C}$ , unless otherwise noted.)

Characteristic	Test Conditions	Symbol	Limits			Unit
			Min	Typ	Max	
Input Offset Voltage At 25°C Overtemperature Range	$V_+ = +4.75\text{ V}$ ; $V_- = -4.75\text{ V}$	$V_{OS}$	– –	6.0 –	7.5 10	mV
Input Bias Current At 25°C Overtemperature Range	$V_+ = +5.25\text{ V}$ ; $V_- = -5.25\text{ V}$	$I_{BIAS}$	– –	7.5 –	20 40	$\mu\text{A}$
Input Offset Current At 25°C Overtemperature Range	$V_+ = +5.25\text{ V}$ ; $V_- = -5.25\text{ V}$	$I_{OS}$	– –	1.0 –	5.0 12	$\mu\text{A}$
Common-Mode Voltage Range	$V_+ = +4.75\text{ V}$ ; $V_- = -4.75\text{ V}$	$V_{CM}$	–3.0	–	+3.0	V
Input Current High	$V_+ = +5.25\text{ V}$ ; $V_- = -5.25\text{ V}$ $V_{IH} = 2.7\text{ V}$ 1G or 2G Strobe Common Strobe S	$I_{IH}$	– –	– –	50 100	$\mu\text{A}$
Input Current Low	$V_{IL} = 0.5\text{ V}$ 1G or 2G Strobe Common Strobe S	$I_{IL}$	– –	– –	–2.0 –4.0	mA
Output Voltage High	$V_{I(S)} = 2.0\text{ V}$ $V_+ = +4.75\text{ V}$ ; $V_- = -4.75\text{ V}$ ; $I_{LOAD} = -1.0\text{ mA}$	$V_{OH}$	2.7	3.4		V
Output Voltage Low	$V_+ = +5.25\text{ V}$ ; $V_- = -5.25\text{ V}$ ; $I_{LOAD} = 20\text{ mA}$	$V_{OL}$			0.5	V
Supply Voltage Positive	–	$V_+$	4.75	5.0	5.25	V
Supply Voltage Negative	–	$V_-$	–4.75	–5.0	–5.25	V
Supply Current Positive	$V_+ = +5.25\text{ V}$ ; $V_- = -5.25\text{ V}$ ; $T_A = 25^\circ\text{C}$	$I_{CC+}$	–	27	35	mA
Supply Current Negative		$I_{CC-}$	–	–15	–28	mA
Short-Circuit Output Current	–	$I_{SC}$	–40	–	–100	mA

## AC ELECTRICAL CHARACTERISTICS ( $T_A = 25^\circ\text{C}$ ; $R_L = 280\ \Omega$ ; $C_L = 15\text{ pF}$ , $V_+ = 5.0\text{ V}$ ; $V_- = 5.0\text{ V}$ , guaranteed by characterization)

Characteristic	From Input	To Output	Symbol	Limits			Unit
				Min	Typ	Max	
<b>Large-Signal Switching Speed</b>							
Propagation Delay Low to High (Note 2)	Amp	Output	$t_{PLH(D)}$	–	9.6	12	ns
High to Low (Note 2)	Amp	Output	$t_{PHL(D)}$	–	8.2	9.0	
Low to High (Note 3)	Strobe	Output	$t_{PLH(S)}$	–	4.8	10	
High to Low (Note 3)	Strobe	Output	$t_{PHL(S)}$	–	3.9	6.0	
Max. Operating Frequency	–	–	$f_{MAX}$	40	55	–	MHz

2. Response time measured from 0 V point of  $\pm 100\text{ mV}_{P-P}$  10 MHz square wave to the 1.5 V point of the output.

3. Response time measured from 1.5 V point of input to 1.5 V point of the output.

TYPICAL PERFORMANCE CHARACTERISTICS

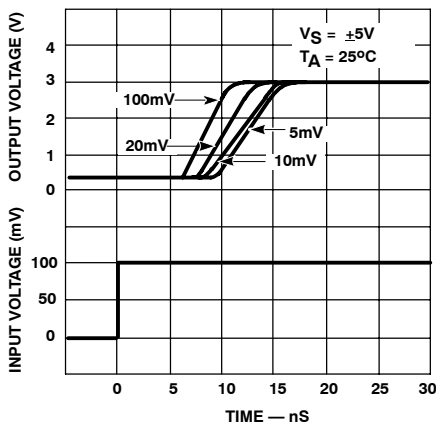

Figure 3. Response Time for Various Input Overdrives

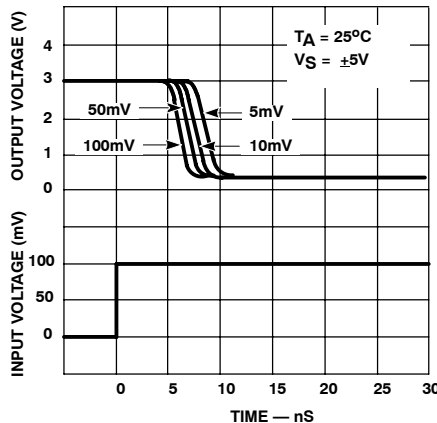

Figure 4. Response Time for Various Input Overdrives

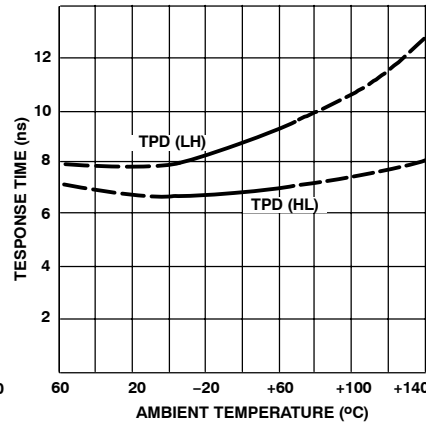

Figure 5. Response Time vs. Temperature

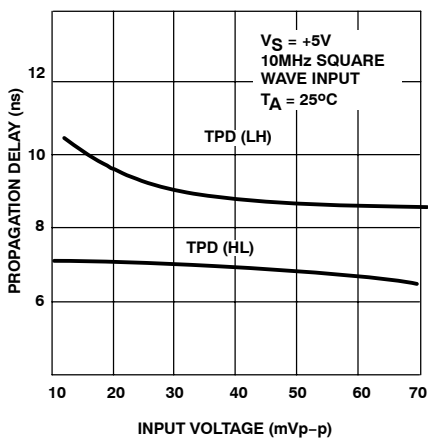

Figure 6. Propagation Delay for Various Input Voltages

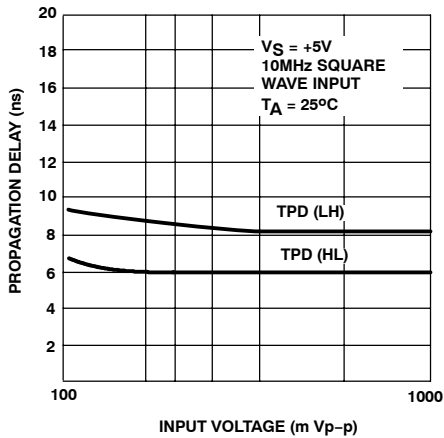

Figure 7. Propagation Delay for Various Input Voltages

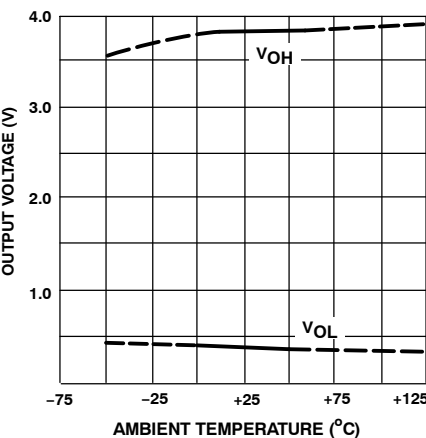

Figure 8. Output Voltage vs. Ambient Temperature

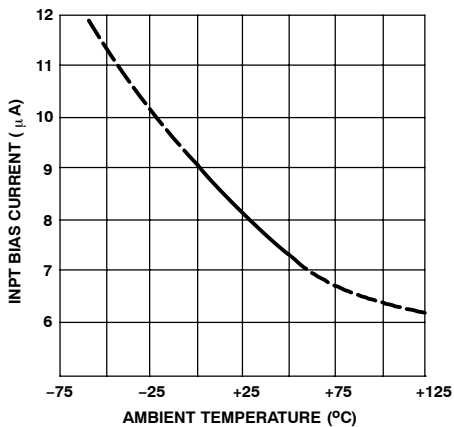

Figure 9. Input Bias Current vs. Ambient Temperature

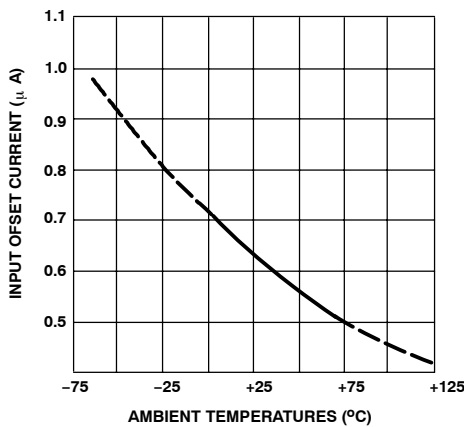

Figure 10. Input Offset Current vs. Ambient Temperature

# NE521

## ORDERING INFORMATION

Device	Temperature Range	Package	Shipping†
NE521D	0 to +70°C	SOIC-14	55 Units/Rail
NE521DG		SOIC-14 (Pb-Free)	
NE521DR2		SOIC-14	2500/Tape & Reel
NE521DR2G		SOIC-14 (Pb-Free)	
NE521N		PDIP-14	25 Units/Rail
NE521NG		PDIP-14 (Pb-Free)	

†For information on tape and reel specifications, including part orientation and tape sizes, please refer to our Tape and Reel Packaging Specification Brochure, BRD8011/D.

# MECHANICAL CASE OUTLINE PACKAGE DIMENSIONS

ON Semiconductor®

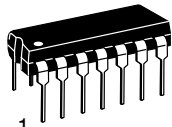

SCALE 1:1

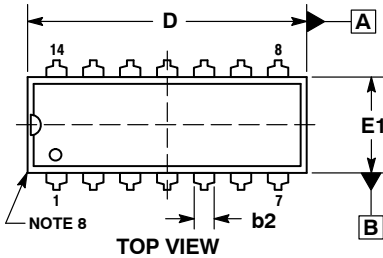

PDIP-14  
CASE 646-06  
ISSUE S

DATE 22 APR 2015

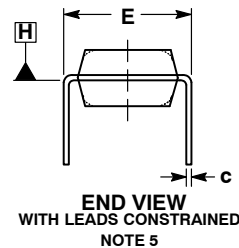

NOTES:

1. DIMENSIONING AND TOLERANCING PER ASME Y14.5M, 1994.
2. CONTROLLING DIMENSION: INCHES.
3. DIMENSIONS A, A1 AND L ARE MEASURED WITH THE PACKAGE SEATED IN JEDEC SEATING PLANE GAUGE GS-3.
4. DIMENSIONS D, D1 AND E1 DO NOT INCLUDE MOLD FLASH OR PROTRUSIONS. MOLD FLASH OR PROTRUSIONS ARE NOT TO EXCEED 0.10 INCH.
5. DIMENSION E IS MEASURED AT A POINT 0.015 BELOW DATUM PLANE H WITH THE LEADS CONSTRAINED PERPENDICULAR TO DATUM C.
6. DIMENSION eB IS MEASURED AT THE LEAD TIPS WITH THE LEADS UNCONSTRAINED.
7. DATUM PLANE H IS COINCIDENT WITH THE BOTTOM OF THE LEADS, WHERE THE LEADS EXIT THE BODY.
8. PACKAGE CONTOUR IS OPTIONAL (ROUNDED OR SQUARE CORNERS).

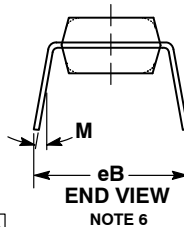
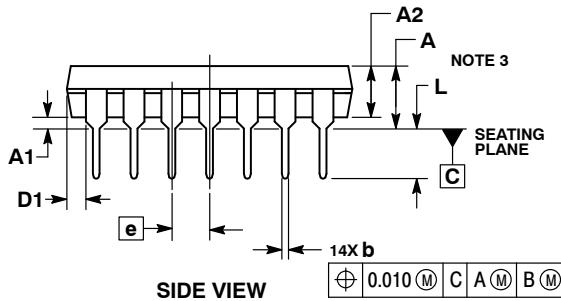

DIM	INCHES		MILLIMETERS	
	MIN	MAX	MIN	MAX
A	----	0.210	----	5.33
A1	0.015	----	0.38	----
A2	0.115	0.195	2.92	4.95
b	0.014	0.022	0.35	0.56
b2	0.060 TYP		1.52 TYP	
C	0.008	0.014	0.20	0.36
D	0.735	0.775	18.67	19.69
D1	0.005	----	0.13	----
E	0.300	0.325	7.62	8.26
E1	0.240	0.280	6.10	7.11
e	0.100 BSC		2.54 BSC	
eB	----	0.430	----	10.92
L	0.115	0.150	2.92	3.81
M	----	10°	----	10°

GENERIC MARKING DIAGRAM\*

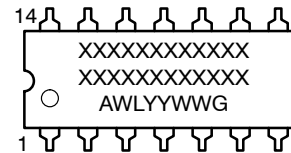

- XXXXX = Specific Device Code
- A = Assembly Location
- WL = Wafer Lot
- YY = Year
- WW = Work Week
- G = Pb-Free Package

\*This information is generic. Please refer to device data sheet for actual part marking. Pb-Free indicator, "G" or microdot "▪", may or may not be present.

STYLES ON PAGE 2

DOCUMENT NUMBER:	98ASB42428B	Electronic versions are uncontrolled except when accessed directly from the Document Repository. Printed versions are uncontrolled except when stamped "CONTROLLED COPY" in red.
DESCRIPTION:	PDIP-14	PAGE 1 OF 2

ON Semiconductor and ON are trademarks of Semiconductor Components Industries, LLC dba ON Semiconductor or its subsidiaries in the United States and/or other countries. ON Semiconductor reserves the right to make changes without further notice to any products herein. ON Semiconductor makes no warranty, representation or guarantee regarding the suitability of its products for any particular purpose, nor does ON Semiconductor assume any liability arising out of the application or use of any product or circuit, and specifically disclaims any and all liability, including without limitation special, consequential or incidental damages. ON Semiconductor does not convey any license under its patent rights nor the rights of others.

**PDIP-14**  
**CASE 646-06**  
**ISSUE S**

DATE 22 APR 2015

**STYLE 1:**  
 PIN 1. COLLECTOR  
 2. BASE  
 3. EMITTER  
 4. NO  
**CONNECTION**  
 5. EMITTER  
 6. BASE  
 7. COLLECTOR  
 8. COLLECTOR  
 9. BASE  
 10. EMITTER  
 11. NO  
**CONNECTION**  
 12. EMITTER  
 13. BASE  
 14. COLLECTOR

**STYLE 2:**  
 CANCELLED

**STYLE 3:**  
 CANCELLED

**STYLE 4:**  
 PIN 1. DRAIN  
 2. SOURCE  
 3. GATE  
 4. NO  
**CONNECTION**  
 5. GATE  
 6. SOURCE  
 7. DRAIN  
 8. DRAIN  
 9. SOURCE  
 10. GATE  
 11. NO  
**CONNECTION**  
 12. GATE  
 13. SOURCE  
 14. DRAIN

**STYLE 5:**  
 PIN 1. GATE  
 2. DRAIN  
 3. SOURCE  
 4. NO CONNECTION  
 5. SOURCE  
 6. DRAIN  
 7. GATE  
 8. GATE  
 9. DRAIN  
 10. SOURCE  
 11. NO CONNECTION  
 12. SOURCE  
 13. DRAIN  
 14. GATE

**STYLE 6:**  
 PIN 1. COMMON CATHODE  
 2. ANODE/CATHODE  
 3. ANODE/CATHODE  
 4. NO CONNECTION  
 5. ANODE/CATHODE  
 6. NO CONNECTION  
 7. ANODE/CATHODE  
 8. ANODE/CATHODE  
 9. ANODE/CATHODE  
 10. NO CONNECTION  
 11. ANODE/CATHODE  
 12. ANODE/CATHODE  
 13. NO CONNECTION  
 14. COMMON ANODE

**STYLE 7:**  
 PIN 1. NO CONNECTION  
 2. ANODE  
 3. ANODE  
 4. NO CONNECTION  
 5. ANODE  
 6. NO CONNECTION  
 7. ANODE  
 8. ANODE  
 9. ANODE  
 10. NO CONNECTION  
 11. ANODE  
 12. ANODE  
 13. NO CONNECTION  
 14. COMMON  
 CATHODE

**STYLE 8:**  
 PIN 1. NO CONNECTION  
 2. CATHODE  
 3. CATHODE  
 4. NO CONNECTION  
 5. CATHODE  
 6. NO CONNECTION  
 7. CATHODE  
 8. CATHODE  
 9. CATHODE  
 10. NO CONNECTION  
 11. CATHODE  
 12. CATHODE  
 13. NO CONNECTION  
 14. COMMON ANODE

**STYLE 9:**  
 PIN 1. COMMON CATHODE  
 2. ANODE/CATHODE  
 3. ANODE/CATHODE  
 4. NO CONNECTION  
 5. ANODE/CATHODE  
 6. ANODE/CATHODE  
 7. COMMON ANODE  
 8. COMMON ANODE  
 9. ANODE/CATHODE  
 10. ANODE/CATHODE  
 11. NO CONNECTION  
 12. ANODE/CATHODE  
 13. ANODE/CATHODE  
 14. COMMON CATHODE

**STYLE 10:**  
 PIN 1. COMMON  
 CATHODE  
 2. ANODE/CATHODE  
 3. ANODE/CATHODE  
 4. ANODE/CATHODE  
 5. ANODE/CATHODE  
 6. NO CONNECTION  
 7. COMMON ANODE  
 8. COMMON  
 CATHODE  
 9. ANODE/CATHODE  
 10. ANODE/CATHODE  
 11. ANODE/CATHODE  
 12. ANODE/CATHODE  
 13. NO CONNECTION  
 14. COMMON ANODE

**STYLE 11:**  
 PIN 1. CATHODE  
 2. CATHODE  
 3. CATHODE  
 4. CATHODE  
 5. CATHODE  
 6. CATHODE  
 7. CATHODE  
 8. ANODE  
 9. ANODE  
 10. ANODE  
 11. ANODE  
 12. ANODE  
 13. ANODE  
 14. ANODE

**STYLE 12:**  
 PIN 1. COMMON CATHODE  
 2. COMMON ANODE  
 3. ANODE/CATHODE  
 4. ANODE/CATHODE  
 5. ANODE/CATHODE  
 6. COMMON ANODE  
 7. COMMON CATHODE  
 8. ANODE/CATHODE  
 9. ANODE/CATHODE  
 10. ANODE/CATHODE  
 11. ANODE/CATHODE  
 12. ANODE/CATHODE  
 13. ANODE/CATHODE  
 14. ANODE/CATHODE

<b>DOCUMENT NUMBER:</b>	<b>98ASB42428B</b>	Electronic versions are uncontrolled except when accessed directly from the Document Repository. Printed versions are uncontrolled except when stamped "CONTROLLED COPY" in red.
<b>DESCRIPTION:</b>	<b>PDIP-14</b>	<b>PAGE 2 OF 2</b>

ON Semiconductor and  are trademarks of Semiconductor Components Industries, LLC dba ON Semiconductor or its subsidiaries in the United States and/or other countries. ON Semiconductor reserves the right to make changes without further notice to any products herein. ON Semiconductor makes no warranty, representation or guarantee regarding the suitability of its products for any particular purpose, nor does ON Semiconductor assume any liability arising out of the application or use of any product or circuit, and specifically disclaims any and all liability, including without limitation special, consequential or incidental damages. ON Semiconductor does not convey any license under its patent rights nor the rights of others.

# MECHANICAL CASE OUTLINE PACKAGE DIMENSIONS

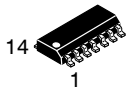

SCALE 1:1

SOIC-14 NB  
CASE 751A-03  
ISSUE L

DATE 03 FEB 2016

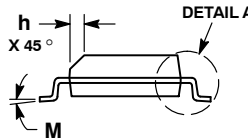
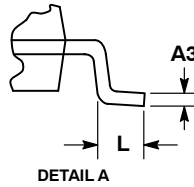

NOTES:

1. DIMENSIONING AND TOLERANCING PER ASME Y14.5M, 1994.
2. CONTROLLING DIMENSION: MILLIMETERS.
3. DIMENSION b DOES NOT INCLUDE DAMBAR PROTRUSION. ALLOWABLE PROTRUSION SHALL BE 0.13 TOTAL IN EXCESS OF AT MAXIMUM MATERIAL CONDITION.
4. DIMENSIONS D AND E DO NOT INCLUDE MOLD PROTRUSIONS.
5. MAXIMUM MOLD PROTRUSION 0.15 PER SIDE.

DIM	MILLIMETERS		INCHES	
	MIN	MAX	MIN	MAX
A	1.35	1.75	0.054	0.068
A1	0.10	0.25	0.004	0.010
A3	0.19	0.25	0.008	0.010
b	0.35	0.49	0.014	0.019
D	8.55	8.75	0.337	0.344
E	3.80	4.00	0.150	0.157
e	1.27 BSC		0.050 BSC	
H	5.80	6.20	0.228	0.244
h	0.25	0.50	0.010	0.019
L	0.40	1.25	0.016	0.049
M	0°	7°	0°	7°

SOLDERING FOOTPRINT\*



DIMENSIONS: MILLIMETERS

\*For additional information on our Pb-Free strategy and soldering details, please download the ON Semiconductor Soldering and Mounting Techniques Reference Manual, SOLDERRM/D.

GENERIC MARKING DIAGRAM\*



- XXXXXX = Specific Device Code
- A = Assembly Location
- WL = Wafer Lot
- Y = Year
- WW = Work Week
- G = Pb-Free Package

\*This information is generic. Please refer to device data sheet for actual part marking. Pb-Free indicator, "G" or microdot "▪", may or may not be present. Some products may not follow the Generic Marking.

STYLES ON PAGE 2

DOCUMENT NUMBER:	98ASB42565B	Electronic versions are uncontrolled except when accessed directly from the Document Repository. Printed versions are uncontrolled except when stamped "CONTROLLED COPY" in red.
DESCRIPTION:	SOIC-14 NB	PAGE 1 OF 2

onsemi and ONSEMI are trademarks of Semiconductor Components Industries, LLC dba onsemi or its subsidiaries in the United States and/or other countries. onsemi reserves the right to make changes without further notice to any products herein. onsemi makes no warranty, representation or guarantee regarding the suitability of its products for any particular purpose, nor does onsemi assume any liability arising out of the application or use of any product or circuit, and specifically disclaims any and all liability, including without limitation special, consequential or incidental damages. onsemi does not convey any license under its patent rights nor the rights of others.

**SOIC-14**  
**CASE 751A-03**  
**ISSUE L**

DATE 03 FEB 2016

STYLE 1:  
 PIN 1. COMMON CATHODE  
 2. ANODE/CATHODE  
 3. ANODE/CATHODE  
 4. NO CONNECTION  
 5. ANODE/CATHODE  
 6. NO CONNECTION  
 7. ANODE/CATHODE  
 8. ANODE/CATHODE  
 9. ANODE/CATHODE  
 10. NO CONNECTION  
 11. ANODE/CATHODE  
 12. ANODE/CATHODE  
 13. NO CONNECTION  
 14. COMMON ANODE

STYLE 2:  
 CANCELLED

STYLE 3:  
 PIN 1. NO CONNECTION  
 2. ANODE  
 3. ANODE  
 4. NO CONNECTION  
 5. ANODE  
 6. NO CONNECTION  
 7. ANODE  
 8. ANODE  
 9. ANODE  
 10. NO CONNECTION  
 11. ANODE  
 12. ANODE  
 13. NO CONNECTION  
 14. COMMON CATHODE

STYLE 4:  
 PIN 1. NO CONNECTION  
 2. CATHODE  
 3. CATHODE  
 4. NO CONNECTION  
 5. CATHODE  
 6. NO CONNECTION  
 7. CATHODE  
 8. CATHODE  
 9. CATHODE  
 10. NO CONNECTION  
 11. CATHODE  
 12. CATHODE  
 13. NO CONNECTION  
 14. COMMON ANODE

STYLE 5:  
 PIN 1. COMMON CATHODE  
 2. ANODE/CATHODE  
 3. ANODE/CATHODE  
 4. ANODE/CATHODE  
 5. ANODE/CATHODE  
 6. NO CONNECTION  
 7. COMMON ANODE  
 8. COMMON CATHODE  
 9. ANODE/CATHODE  
 10. ANODE/CATHODE  
 11. ANODE/CATHODE  
 12. ANODE/CATHODE  
 13. NO CONNECTION  
 14. COMMON ANODE

STYLE 6:  
 PIN 1. CATHODE  
 2. CATHODE  
 3. CATHODE  
 4. CATHODE  
 5. CATHODE  
 6. CATHODE  
 7. CATHODE  
 8. ANODE  
 9. ANODE  
 10. ANODE  
 11. ANODE  
 12. ANODE  
 13. ANODE  
 14. ANODE

STYLE 7:  
 PIN 1. ANODE/CATHODE  
 2. COMMON ANODE  
 3. COMMON CATHODE  
 4. ANODE/CATHODE  
 5. ANODE/CATHODE  
 6. ANODE/CATHODE  
 7. ANODE/CATHODE  
 8. ANODE/CATHODE  
 9. ANODE/CATHODE  
 10. ANODE/CATHODE  
 11. COMMON CATHODE  
 12. COMMON ANODE  
 13. ANODE/CATHODE  
 14. ANODE/CATHODE

STYLE 8:  
 PIN 1. COMMON CATHODE  
 2. ANODE/CATHODE  
 3. ANODE/CATHODE  
 4. NO CONNECTION  
 5. ANODE/CATHODE  
 6. ANODE/CATHODE  
 7. COMMON ANODE  
 8. COMMON ANODE  
 9. ANODE/CATHODE  
 10. ANODE/CATHODE  
 11. NO CONNECTION  
 12. ANODE/CATHODE  
 13. ANODE/CATHODE  
 14. COMMON CATHODE

<b>DOCUMENT NUMBER:</b>	<b>98ASB42565B</b>	Electronic versions are uncontrolled except when accessed directly from the Document Repository. Printed versions are uncontrolled except when stamped "CONTROLLED COPY" in red.
<b>DESCRIPTION:</b>	<b>SOIC-14 NB</b>	<b>PAGE 2 OF 2</b>

onsemi and onsemi are trademarks of Semiconductor Components Industries, LLC dba onsemi or its subsidiaries in the United States and/or other countries. onsemi reserves the right to make changes without further notice to any products herein. onsemi makes no warranty, representation or guarantee regarding the suitability of its products for any particular purpose, nor does onsemi assume any liability arising out of the application or use of any product or circuit, and specifically disclaims any and all liability, including without limitation special, consequential or incidental damages. onsemi does not convey any license under its patent rights nor the rights of others.

**onsemi**, **Onsemi**, and other names, marks, and brands are registered and/or common law trademarks of Semiconductor Components Industries, LLC dba "**onsemi**" or its affiliates and/or subsidiaries in the United States and/or other countries. **onsemi** owns the rights to a number of patents, trademarks, copyrights, trade secrets, and other intellectual property. A listing of **onsemi**'s product/patent coverage may be accessed at [www.onsemi.com/site/pdf/Patent-Marking.pdf](http://www.onsemi.com/site/pdf/Patent-Marking.pdf). **onsemi** reserves the right to make changes at any time to any products or information herein, without notice. The information herein is provided "as-is" and **onsemi** makes no warranty, representation or guarantee regarding the accuracy of the information, product features, availability, functionality, or suitability of its products for any particular purpose, nor does **onsemi** assume any liability arising out of the application or use of any product or circuit, and specifically disclaims any and all liability, including without limitation special, consequential or incidental damages. Buyer is responsible for its products and applications using **onsemi** products, including compliance with all laws, regulations and safety requirements or standards, regardless of any support or applications information provided by **onsemi**. "Typical" parameters which may be provided in **onsemi** data sheets and/or specifications can and do vary in different applications and actual performance may vary over time. All operating parameters, including "Typicals" must be validated for each customer application by customer's technical experts. **onsemi** does not convey any license under any of its intellectual property rights nor the rights of others. **onsemi** products are not designed, intended, or authorized for use as a critical component in life support systems or any FDA Class 3 medical devices or medical devices with a same or similar classification in a foreign jurisdiction or any devices intended for implantation in the human body. Should Buyer purchase or use **onsemi** products for any such unintended or unauthorized application, Buyer shall indemnify and hold **onsemi** and its officers, employees, subsidiaries, affiliates, and distributors harmless against all claims, costs, damages, and expenses, and reasonable attorney fees arising out of, directly or indirectly, any claim of personal injury or death associated with such unintended or unauthorized use, even if such claim alleges that **onsemi** was negligent regarding the design or manufacture of the part. **onsemi** is an Equal Opportunity/Affirmative Action Employer. This literature is subject to all applicable copyright laws and is not for resale in any manner.

## ADDITIONAL INFORMATION

### TECHNICAL PUBLICATIONS:

Technical Library: [www.onsemi.com/design/resources/technical-documentation](http://www.onsemi.com/design/resources/technical-documentation)  
onsemi Website: [www.onsemi.com](http://www.onsemi.com)

### ONLINE SUPPORT: [www.onsemi.com/support](http://www.onsemi.com/support)

For additional information, please contact your local Sales Representative at [www.onsemi.com/support/sales](http://www.onsemi.com/support/sales)



## Looking for pricing, stock, or lifecycle information?

Click below to explore more details on WIN SOURCE:

 [View NE521DR2 on WIN SOURCE](#)

 [ON Semiconductor](#) Information

## Optimize Your Supply Chain with WIN SOURCE Solutions

-  Global Sourcing Solution
-  Obsolete Management
-  Cost Control Management
-  Shortage Management
-  Alternative Solution
-  Excess Inventory Management