



THE DATASHEET OF BT05VG2



Device Features

- OIP3 = 40.5 dBm @ 1900 MHz
- Gain = 19.0 dB @ 1900 MHz
- Output P1 dB = 22.7 dBm @ 1900 MHz
- Patented Over Voltage Protection Circuit
- RoHS2-compliant SOT-89 SMT package



Product Description

BeRex's BT05VG2 is a high performance and a high dynamic range amplifier in a low cost surface mount package(SOT-89) with a RoHS2-compliant, that incorporates reliable heterojunction-bipolar-transistor (HBT) devices fabricated with InGaP GaAs technology. This device is designed for use where high linearity is required and features high OIP3 and P1 with low consumption current(85mA) and requires a few external matching components such as a DC blocking capacitors on the In/Output pin, a bypass capacitor and a RF choke for the out port.

All devices are 100% RF/DC tested.

Applications

- Base station Infrastructure/RFID
- Commercial/Industrial/Military wireless system
- Wireless LAN

Application Circuits

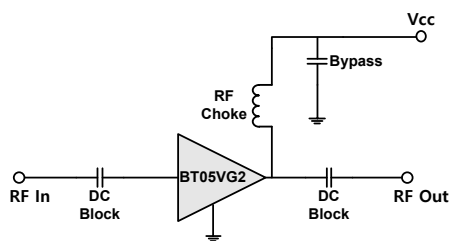

*External matching circuit: refer to the page 5 to 11.

Electrical Specifications

Device performance _ measured on a BeRex evaluation board at 25°C, Vd=5V, 50 Ω system.

| Parameter | Conditions | Min | Typ | Max | Unit |
|-----------------------------|-----------------------------|------|-------|------|------|
| Operational Frequency Range | | 1500 | | 4000 | MHz |
| Test Frequency | | | 1900 | | MHz |
| Gain | | 17.5 | 19.0 | | dB |
| Input Return Loss | | | -18.5 | | dB |
| Output Return Loss | | | -14.9 | | dB |
| Output IP3 | 11 dBm / tone , Δf=1 MHz | 37.5 | 40.5 | | dBm |
| Output P1dB | | 21.7 | 22.7 | | dBm |
| Noise Figure | | | 3.9 | | dB |

Recommended Operating Conditions

| Parameter | Min | Typ | Max | Unit |
|--|------|-----|------|------|
| Bandwidth | 1500 | | 4000 | MHz |
| I _C @ (V _C = 5V) | 71 | 88 | 105 | mA |
| V _C | 4.75 | 5.0 | 5.25 | V |
| R _{TH} | | 50 | | °C/W |
| Operating Case Temperature | -40 | | +85 | °C |

Electrical specifications are measured at specified test conditions.

Specifications are not guaranteed over all recommended operating conditions.

Absolute Maximum Ratings

| Parameter | Rating | Unit |
|----------------------|-------------|------|
| Storage Temperature | -55 to +155 | °C |
| Junction Temperature | +175 | °C |
| Supply Voltage | +6.0 | V |
| Supply Current | 180 | mA |
| Input RF Power | 23 | dBm |

Operation of this device above any of these parameters may result in permanent damage.

Typical Performance (Vc=5V, Ic=88mA, T=25°C)

| Parameter | Frequency | | | | Unit |
|--------------|-----------|-------|-------|-------|------|
| | 1900 | 2100 | 2450 | 3500 | MHz |
| Gain | 19.0 | 18.0 | 16.5 | 13.7 | dB |
| S11 | -18.5 | -15.6 | -26.1 | -22.0 | dB |
| S22 | -14.9 | -19.1 | -19.4 | -20.0 | dB |
| OIP3 | 40.5 | 38.0 | 38.0 | 39.0 | dBm |
| P1dB | 22.7 | 22.0 | 23.2 | 23.5 | dBm |
| Noise Figure | 3.9 | 4.0 | 4.2 | 4.4 | dB |

V-I Characteristics

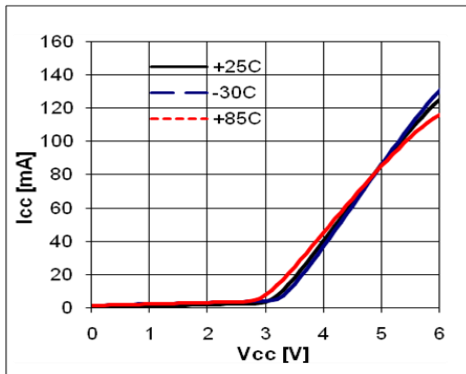

BeRex SOT89 Evaluation Board

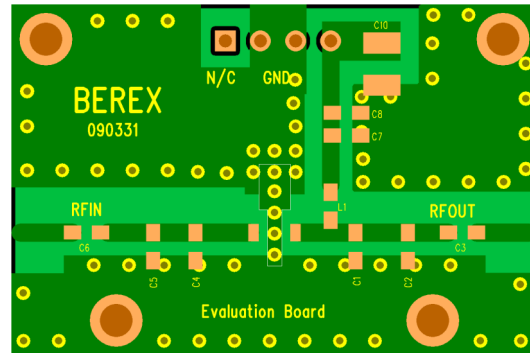

*Dielectric constant _ 4.2 *RF pattern width 52mil *31mil thick FR4 PCB

ACLR

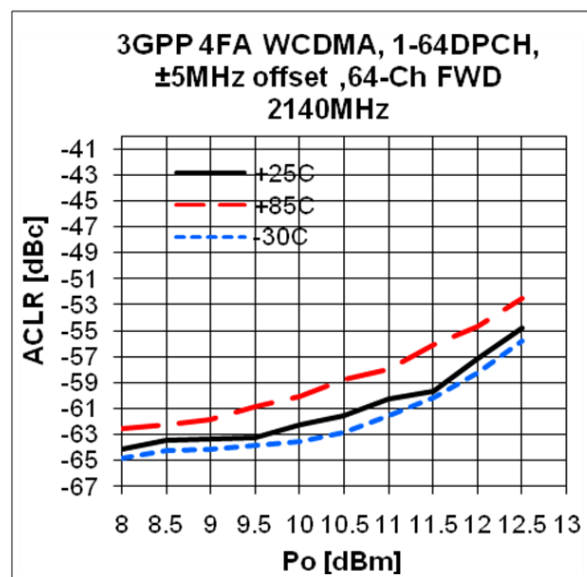

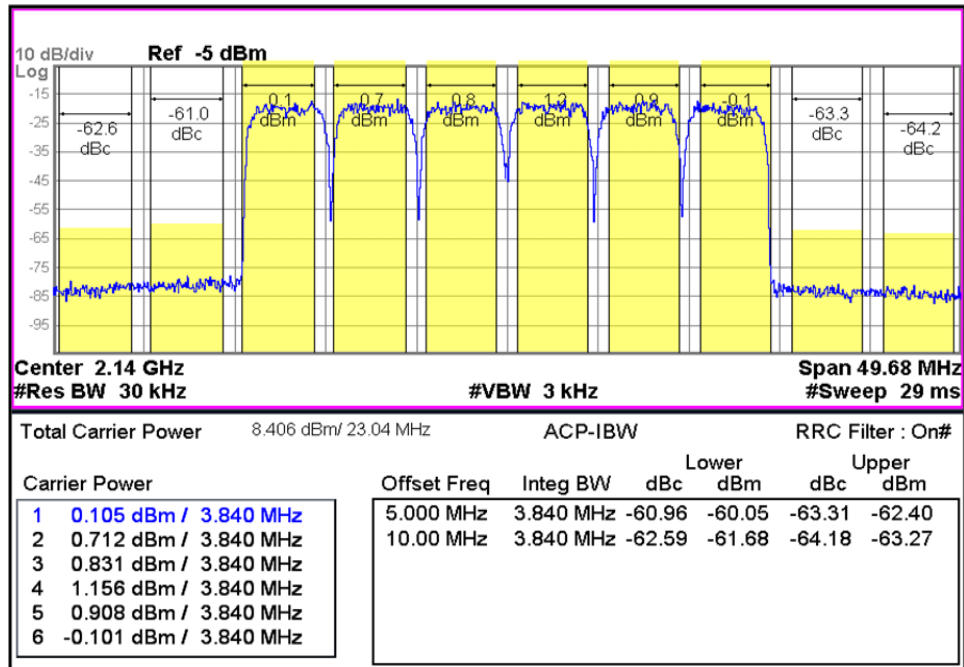
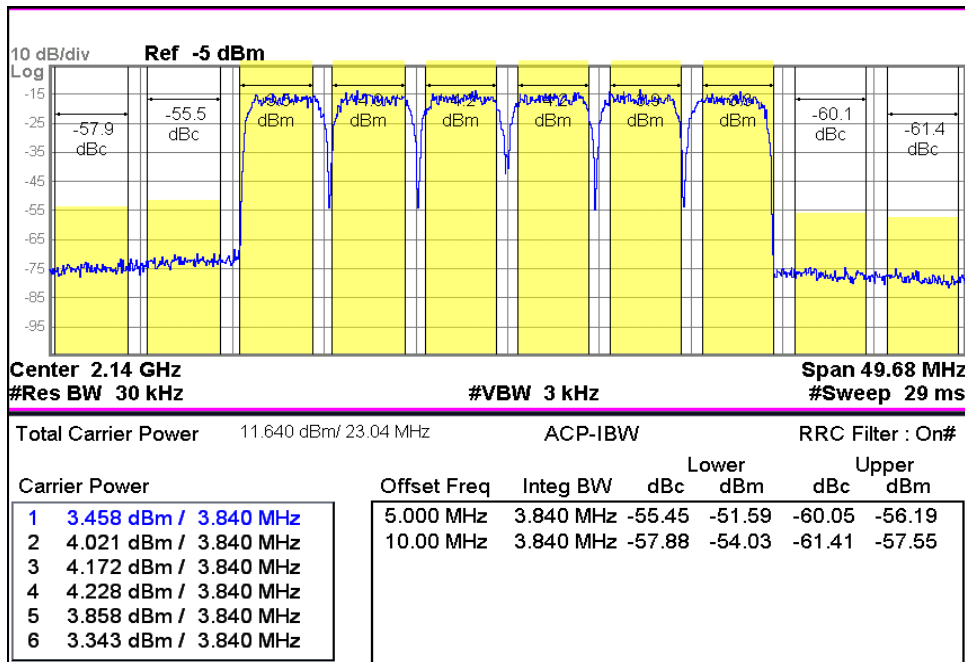
WCDMA 6FA 2140 -60dBc

WCDMA 6FA 2140 -55dBc

Typical Device Data

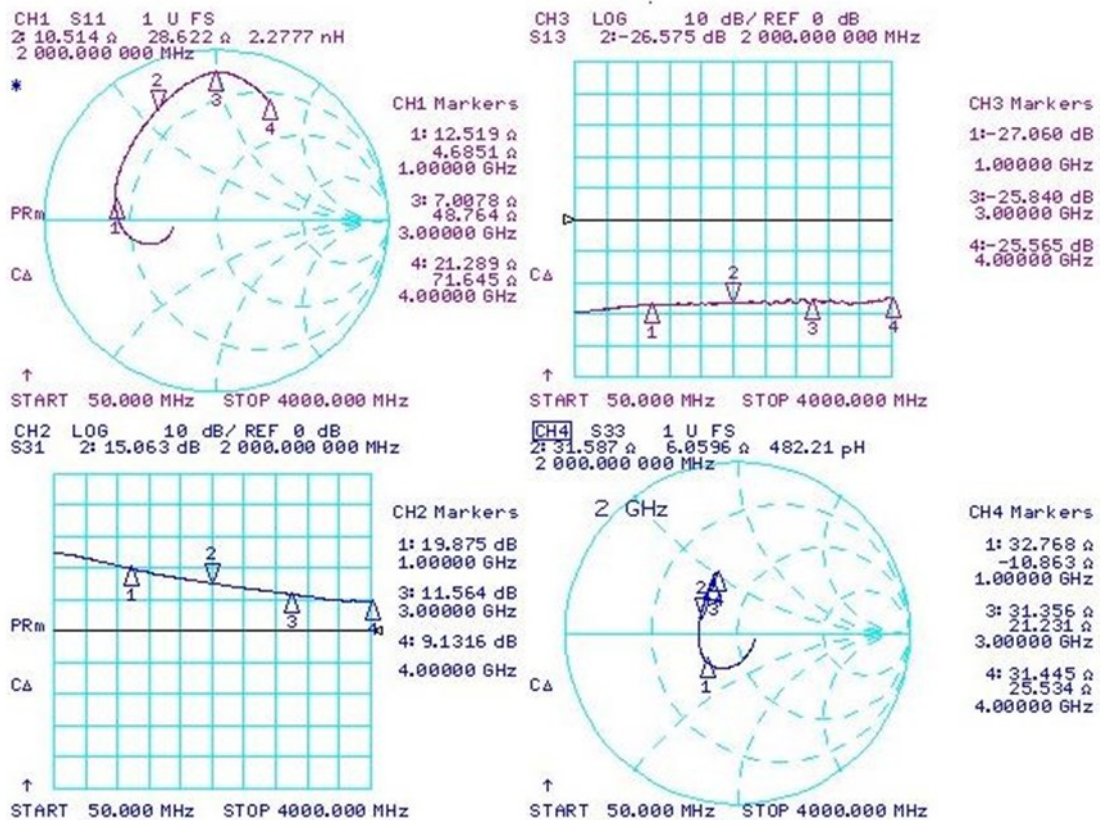
S-parameters (Vc=5V, Ic=88mA, T=25°C)



S-Parameter

(Vdevice = 5.0V, Icc = 88mA, T = 25 °C, calibrated to device leads)

| Freq [MHz] | S11 | S11 | S21 | S21 | S12 | S12 | S22 | S22 |
|---------------|-------|----------|--------|---------|-------|-------|-------|----------|
| | [Mag] | [Ang] | [Mag] | [Ang] | [Mag] | [Ang] | [Mag] | [Ang] |
| 100 | 0.270 | -166.495 | 17.095 | 169.234 | 0.034 | 2.969 | 0.112 | -36.553 |
| 500 | 0.484 | -165.550 | 13.796 | 134.745 | 0.039 | 9.708 | 0.209 | -115.545 |
| 1000 | 0.603 | 169.297 | 9.839 | 107.471 | 0.045 | 8.523 | 0.243 | -138.751 |
| 1500 | 0.649 | 142.996 | 7.265 | 89.329 | 0.046 | 6.978 | 0.224 | -166.419 |
| 2000 | 0.727 | 119.846 | 5.645 | 75.285 | 0.047 | 7.094 | 0.232 | 159.675 |
| 2500 | 0.812 | 103.333 | 4.578 | 65.518 | 0.046 | 7.622 | 0.276 | 133.104 |
| 3000 | 0.860 | 91.901 | 3.760 | 57.542 | 0.050 | 4.871 | 0.326 | 118.486 |
| 3500 | 0.845 | 82.120 | 3.142 | 48.480 | 0.046 | 4.636 | 0.365 | 112.242 |
| 4000 | 0.768 | 68.638 | 2.817 | 40.568 | 0.054 | 0.845 | 0.369 | 110.182 |

Application Circuit: 1900 MHz

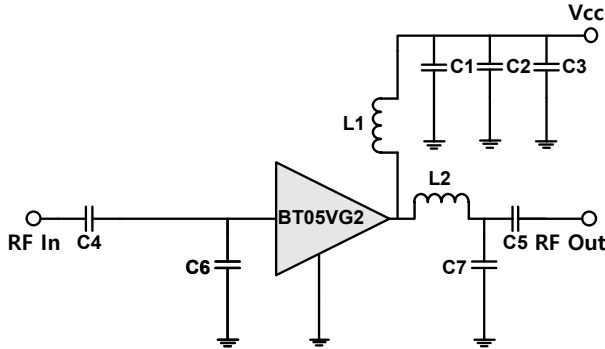
| Schematic Diagram | BOM | Tolerance | |
|---|-------|-----------|-------|
|  | C1 | 100pF | ± 5% |
| | C2 | 1000pF | ± 5% |
| | C3 | 10uF | ± 20% |
| | C4 | 56pF | ± 5% |
| | C5 | 56pF | ± 5% |
| | C6 | 2.7pF | ± 5% |
| | C7 | 1.8pF | ± 5% |
| | L1 | 39nH | ±5% |
| L2 | 1.5nH | ±5% | |

| Note: | |
|-------|---|
| 1. | PCB: 31mil thick FR4. |
| 2. | Distance between the center of the shunt cap(C6) and the input pin of BT05VG2 _ <u>0.8mm.</u> |
| 3. | Distance between the center of the series inductor(L2) and the output pin of BT05VG2 _ <u>3.5mm.</u> |
| 4. | Distance between the center of the shunt cap(C7) and the output pin of BT05VG2 _ <u>9.0mm.</u> |

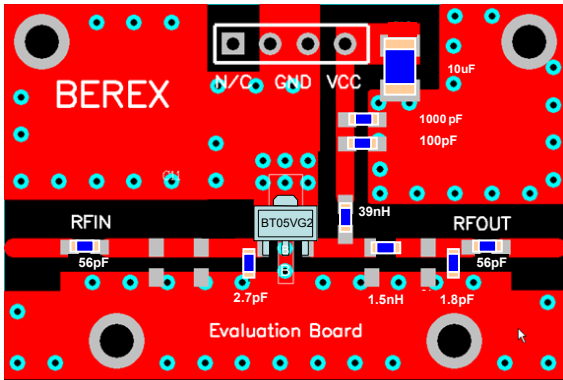

Typical Performance (Vc=5V, Ic=88mA, T=25°C)

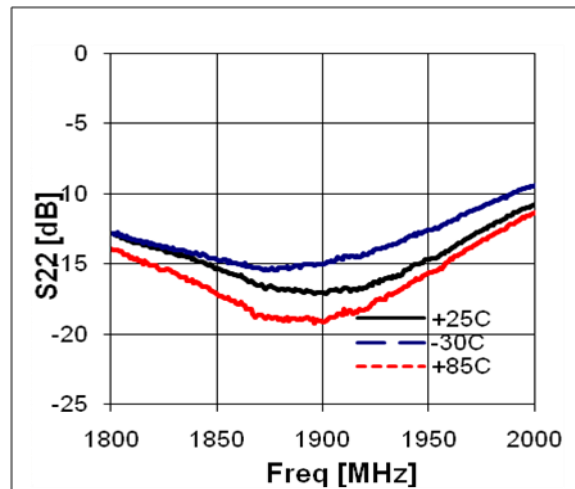
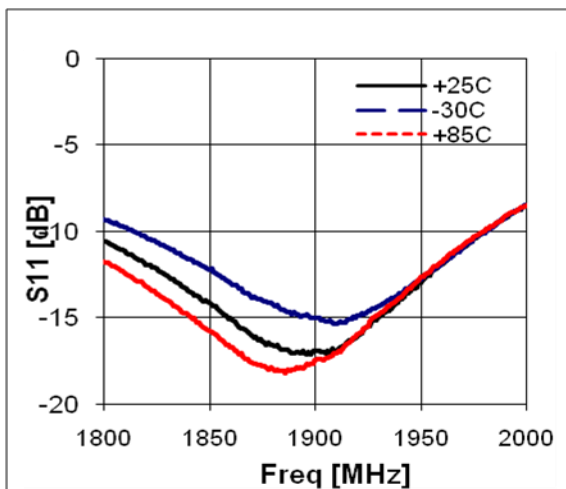

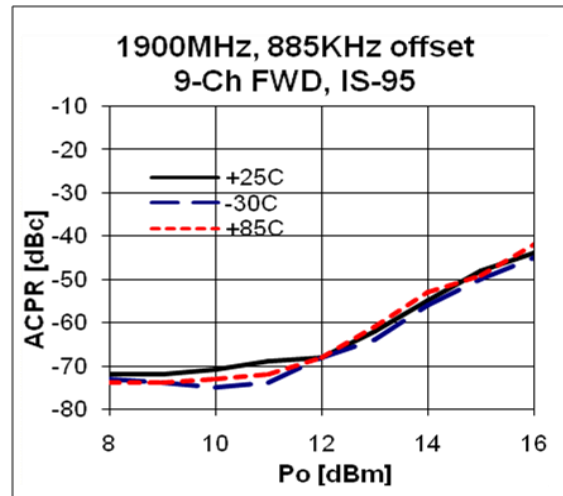
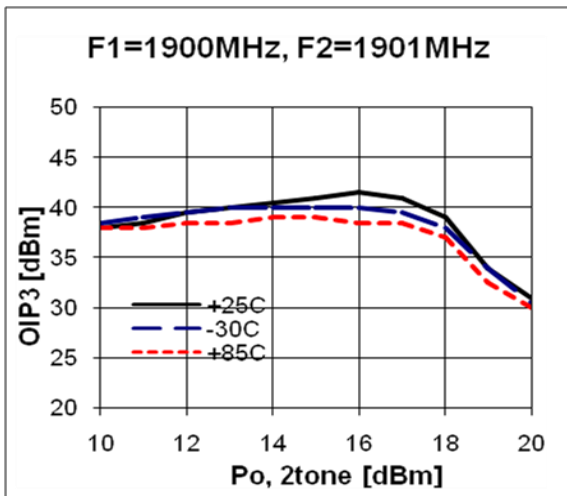
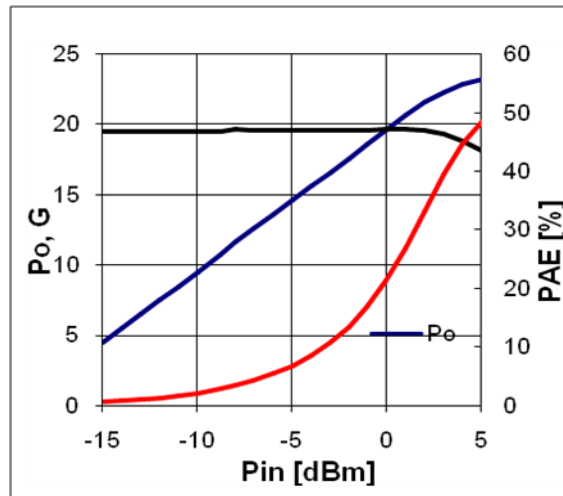
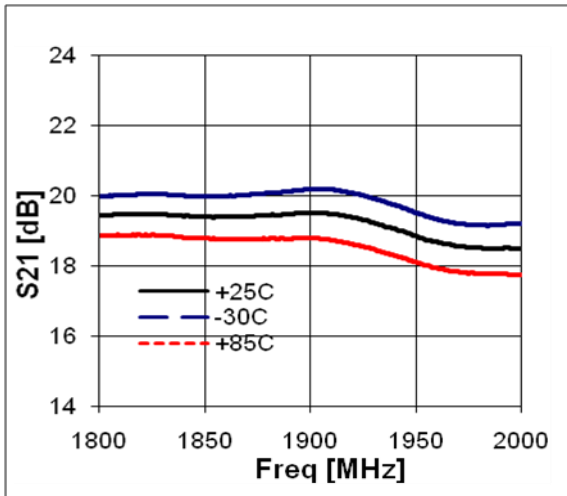

Application Circuit: 2100 MHz

| Schematic Diagram | BOM | Tolerance | |
|-------------------|-----|-----------|-------|
| | C1 | 100pF | ± 5% |
| | C2 | 1000pF | ± 5% |
| | C3 | 10uF | ± 20% |
| | C4 | 56pF | ± 5% |
| | C5 | 56pF | ± 5% |
| | C6 | 2.2pF | ± 5% |
| | C7 | 1.5pF | ± 5% |
| | L1 | 47nH | ±5% |
| | L2 | 1nH | ±5% |

Note:

1. PCB: 31mil thick FR4.
2. Distance between the center of the shunt cap(C6) and the input pin of BT05VG2 _ **0.7mm.**
3. Distance between the center of the series inductor (L2) and the output pin of BT05VG2 _ **3.5mm.**
4. Distance between the center of the shunt cap(C7) and the output pin of BT05VG2 _ **9.5mm.**

Typical Performance (Vc=5V, Ic=88mA, T=25°C)

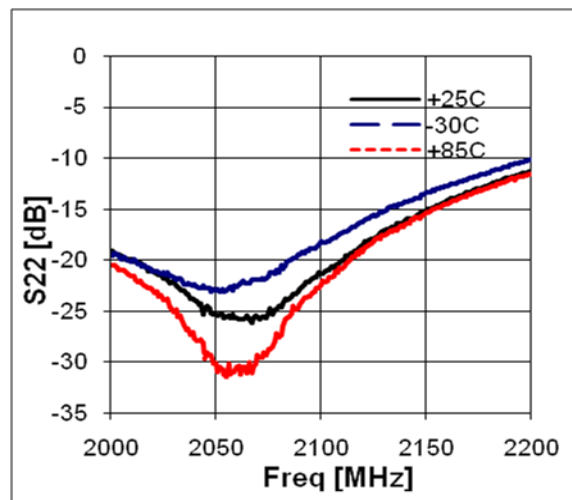
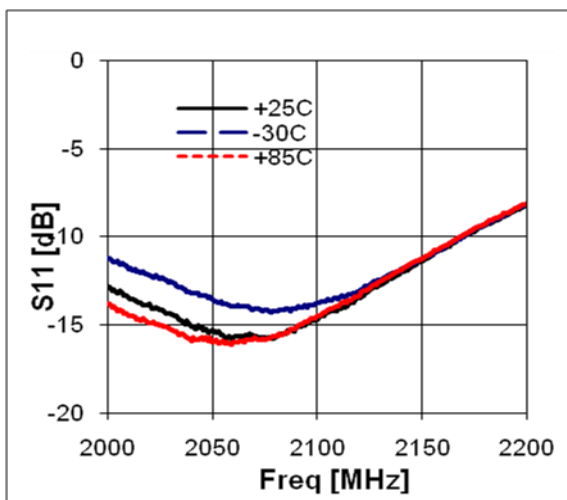

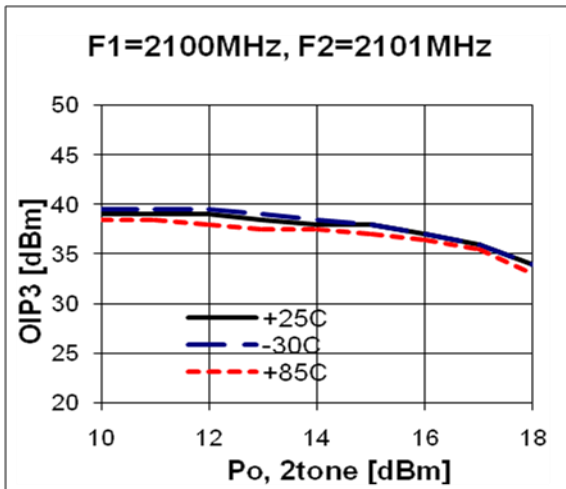
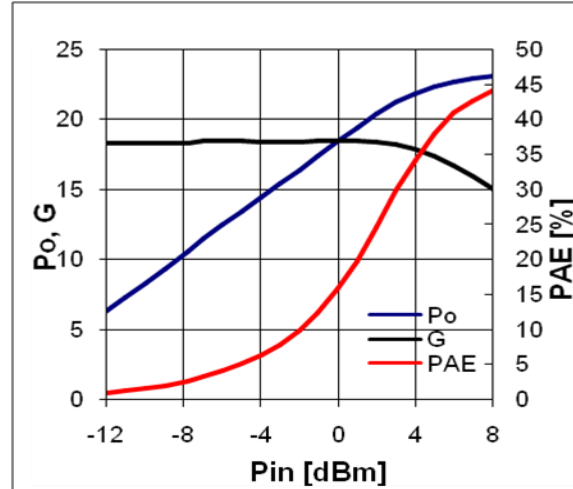
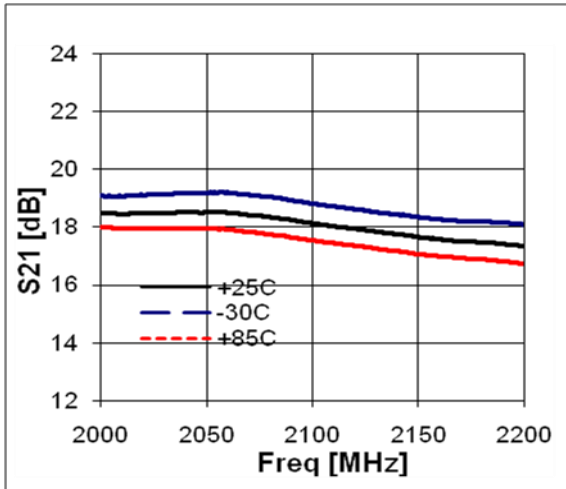

Application Circuit: 2450MHz

| Schematic Diagram | BOM | Tolerance | |
|-------------------|-----|-----------|-------|
| | C1 | 100pF | ± 5% |
| | C2 | 1000pF | ± 5% |
| | C3 | 10uF | ± 20% |
| | C4 | 100pF | ± 5% |
| | C5 | 1pF | ± 5% |
| | C6 | 1.5pF | ± 5% |
| | C7 | 0.5pF | ± 5% |
| | L1 | 39nH | ±5% |
| | L2 | 2.7nH | ±5% |
| L3 | 1nH | ±5% | |

| | |
|--|---|
| | <p>Note: 1. PCB: 31mil thick FR4.</p> <p>2. Distance between the center of the series inductor (L2) and the input pin of BT05VG2 _ <u>2.5mm.</u></p> <p>3. Distance between the center of the shunt cap(C6) and the input pin of BT05VG2 _ <u>0.5mm.</u></p> <p>4. Distance between the center of the series inductor (L3) and the output pin of BT05VG2 _ <u>3.5mm.</u></p> <p>5. Distance between the center of the shunt cap(C7) and the output pin of BT05VG2 _ <u>5.5mm.</u></p> |
|--|---|

Typical Performance (Vc=5V, Ic=88mA, T=25°C)

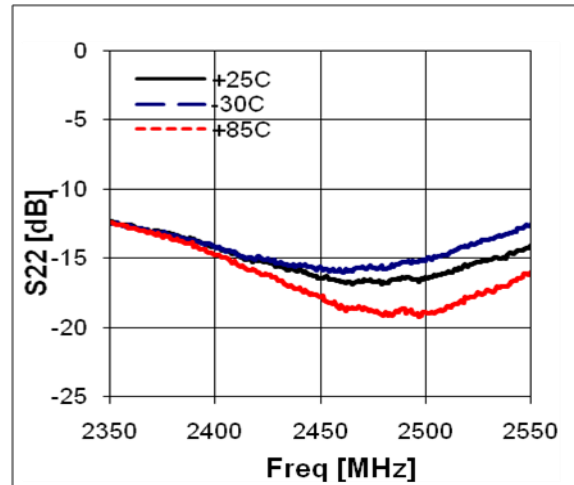
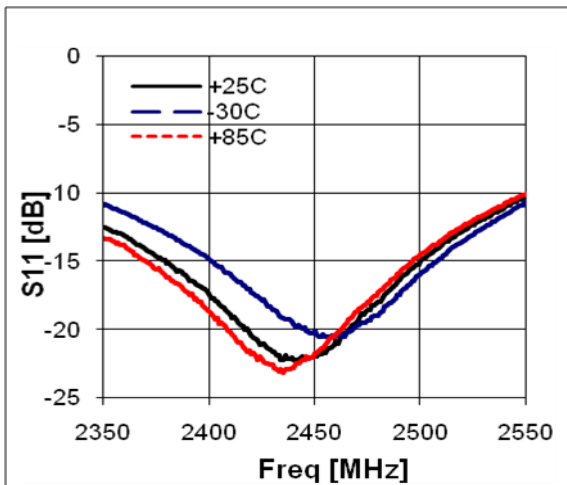

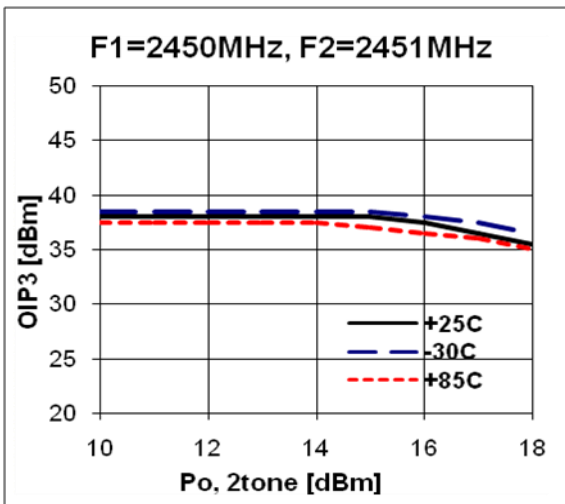
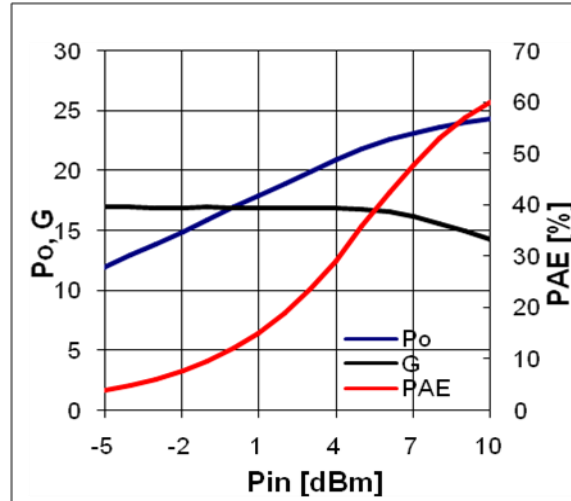
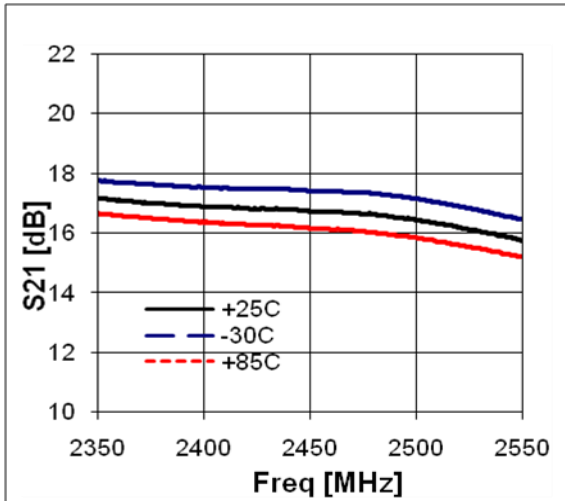

Application Circuit: 3500MHz

| Schematic Diagram | BOM | Tolerance | |
|-------------------|------|-----------|-------|
| | C1 | 100pF | ± 5% |
| | C2 | 1000pF | ± 5% |
| | C3 | 10uF | ± 20% |
| | C4 | 22pF | ± 5% |
| | C5 | 22pF | ± 5% |
| | C6 | 0.5pF | ± 5% |
| | C7 | 0.75pF | ±5% |
| | C8 | 0.5pF | ±5% |
| L1 | 33nH | ±5% | |

Note:

1. PCB: 31mil thick FR4.
2. Distance between the center of the series cap(C6) and the input pin of BT05VG2 _ **2.5mm.**
3. Distance between the center of the shunt cap(C7) and the input pin of BT05VG2 _ **7.1mm.**
4. Distance between the center of the shunt cap(C8) and the output pin of BT05VG2 _ **7.7mm.**

Typical Performance (Vc=5V, Ic=88mA, T=25°C)

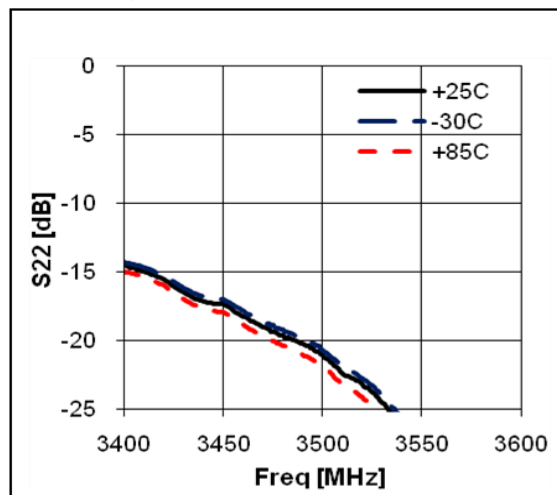
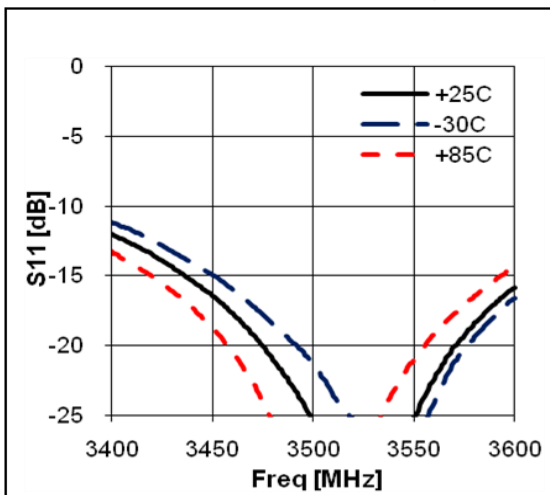

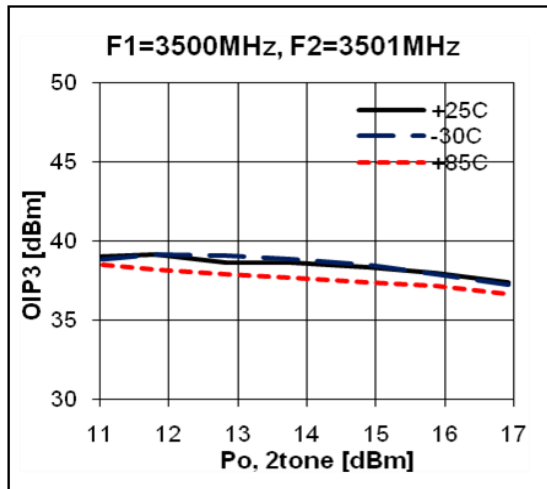
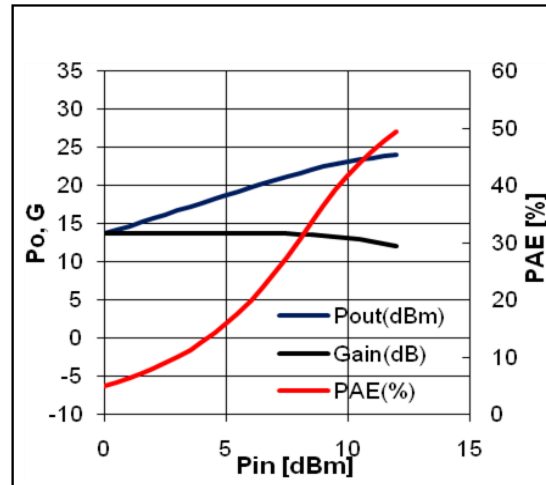
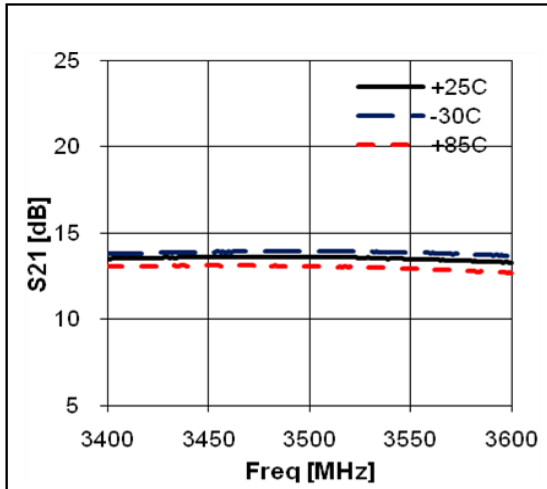

Package Outline Dimension

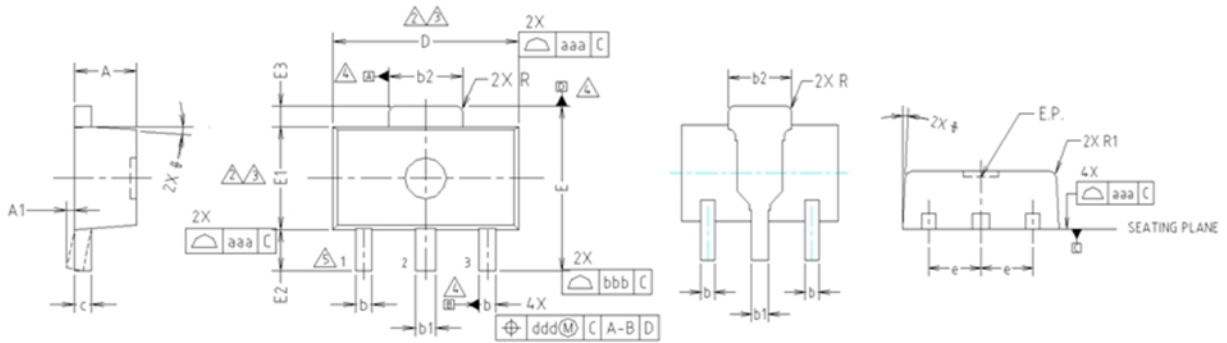

- NOTE:**
 1. DIMENSIONS IN MILLIMETERS.
- ⚠ DIMENSION D DOES NOT INCLUDE MOLD FLASH, PROTRUSIONS OR GATE BURRS. MOLD FLASH, PROTRUSIONS OR GATE BURRS SHALL NOT EXCEED 0.5mm PER END. DIMENSION E1 DOES NOT INCLUDE INTERLEAD FLASH OR PROTRUSION. INTERLEAD FLASH OR PROTRUSION SHALL NOT EXCEED 0.5mm PER SIDE.
 - ⚠ DIMENSIONS D AND E1 ARE DETERMINED AT THE OUTMOST EXTREMES OF THE PLASTIC BODY EXCLUSIVE OF MOLD FLASH, TIE BAR BURRS, GATE BURRS AND INTERLEAD FLASH, BUT INCLUDING ANY MISMATCH BETWEEN THE TOP AND BOTTOM OF THE PLASTIC BODY.
 - ⚠ DATUMS A, B AND D TO BE DETERMINED 0.18mm FROM THE LEAD TIP.
 - ⚠ TERMINAL NUMBERS ARE SHOWN FOR REFERENCE ONLY.

| SYMBOL | MILLIMETERS | | | NOTE |
|--------|---------------------------------|---------|---------|------|
| | MINIMUM | NOMINAL | MAXIMUM | |
| A | 1.40 | 1.50 | 1.60 | |
| A1 | 0.00 | — | 0.10 | |
| b | 0.38 | 0.42 | 0.48 | |
| b1 | 0.48 | 0.52 | 0.58 | |
| b2 | 1.79 | 1.82 | 1.87 | |
| c | 0.40 | 0.42 | 0.46 | |
| D | 4.40 | 4.50 | 4.70 | 2,3 |
| E | 3.70 | 4.00 | 4.30 | |
| E1 | 2.40 | 2.50 | 2.70 | 2,3 |
| E2 | 0.80 | 1.00 | 1.20 | |
| E3 | 0.40 | 0.50 | 0.60 | |
| e | 1.50 TYP. | | | |
| φ | 4° TYP. | | | |
| R | 0.15 TYP. | | | |
| R1 | — | — | 0.20 | |
| SYMBOL | TOLERANCES OF FORM AND POSITION | | NOTE | |
| aaa | 0.15 | | | |
| bbb | 0.20 | | | |
| ccc | 0.10 | | | |
| ddd | 0.10 | | | |

Suggested PCB Land Pattern and PAD Layout

PCB Land Pattern

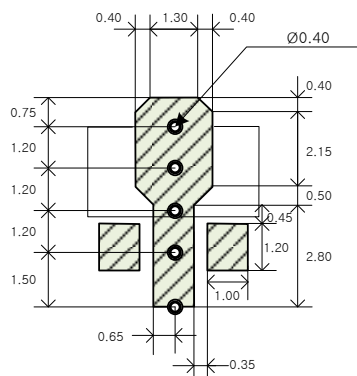

Note : All dimension are in millimeters

PCB lay out _ on BeRex website

PCB Mounting

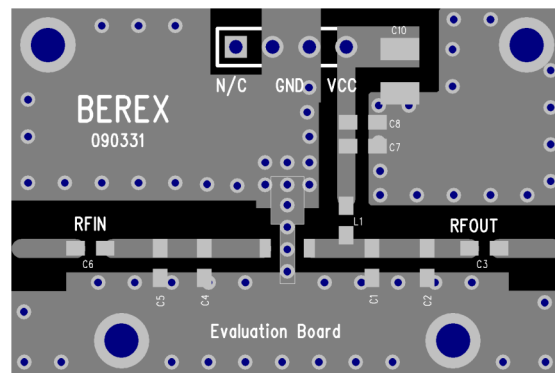

Package Marking

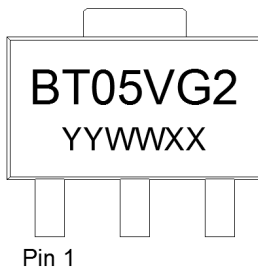

YY = Year, WW = Working Week,
XX = Wafer No.

Tape & Reel

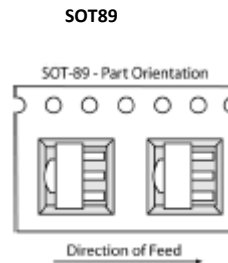

Packaging information:

Tape Width (mm): 12
Reel Size (inches): 7
Device Cavity Pitch (mm): 8
Devices Per Reel: 1000

Lead plating finish

100% Tin Matte finish

(All BeRex products undergoes a 1 hour, 150 degree C, Anneal bake to eliminate thin whisker growth concerns.)

MSL / ESD Rating

| | |
|--------------------|--|
| ESD Rating: | Class 1B |
| Value: | Passes <1000V |
| Test: | Human Body Model (HBM) |
| Standard: | JEDEC Standard JESD22-A114 |
| | |
| MSL Rating: | Level 1 at +260°C convection reflow |
| Standard: | JEDEC Standard J-STD-020 |



Proper ESD procedures should be followed when handling this device.

RoHS Compliance

This part is compliant with Restrictions on the Use of Certain Hazardous Substances in Electrical and Electronic Equipment (RoHS) Directive 2011/65/EU as amended by Directive 2015/863/EU.

This product also is compliant with a concentration of the Substances of Very High Concern (SVHC) candidate list which are contained in a quantity of less than 0.1%(w/w) in each components of a product and/or its packaging placed on the European Community market by the BeRex and Suppliers.

NATO CAGE code:

| | | | | |
|---|---|---|---|---|
| 2 | N | 9 | 6 | F |
|---|---|---|---|---|

Looking for pricing, stock, or lifecycle information?

Click below to explore more details on WIN SOURCE:

 [View BT05VG2 on WIN SOURCE](#)

 [BeRex Corporation](#) Information

Optimize Your Supply Chain with WIN SOURCE Solutions

-  Global Sourcing Solution
-  Obsolete Management
-  Cost Control Management
-  Shortage Management
-  Alternative Solution
-  Excess Inventory Management