

## Data and signal line chokes

Common-mode chokes, ring core  
0.005 ... 47 mH, 100 ... 1200 mA, +60 °C

**Series/Type:**            **B82793C0/S0**

**Date:**                    March 2016

© EPCOS AG 2016. Reproduction, publication and dissemination of this publication, enclosures hereto and the information contained therein without EPCOS' prior express consent is prohibited.

EPCOS AG is a TDK Group Company.

**SMD**

**Rated voltage 42 V AC/80 V DC**  
**Rated inductance 0.005 ... 47 mH**  
**Rated current 100 ... 1200 mA**

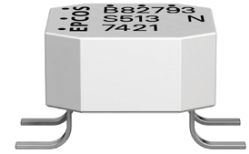
**Construction**

- Current-compensated double choke
- Ferrite core
- LCP case (UL 94 V-0), silicone potting
- Bifilar winding (B82793C0)
- Sector winding (B82793S0)

**Features**

- High rated currents, reduced components height
- Qualified to AEC-Q200 ( $L \leq 4.7$  mH)
- Suitable for reflow soldering
- RoHS-compatible

**Function**

- B82793C0:  
Suppression of asymmetrical interference coupled in on lines, whereas data signals up to some MHz can pass unaffectedly.
- B82793S0:  
Suppression of asymmetrical and symmetrical interference (by  $L_{\text{stray}}$ ) coupled in on lines. The high-frequency portions of the symmetrical data signal are decreased so far that EMC problems can be significantly reduced.

**Applications**

- Automotive applications, e.g. CAN bus
- Industrial applications
- Types with  $L_R > 4.7$  mH only for telecom applications

**Terminals**

- Base material CuSn6
- Layer composition Ni, Sn
- Hot-dipped

**Marking**

- Marking on component: Manufacturer, process location (coded), winding method (coded), ordering code (short form), date of manufacture (YWWD)
- Minimum data on reel: Manufacturer, ordering code, L value and tolerance, quantity, date of packing

**Delivery mode and packing unit**

- 16-mm blister tape, wound on 330-mm  $\varnothing$  reel
- Packing unit: 1500 pcs./reel

**SMD**

**Dimensional drawing and pin configuration**

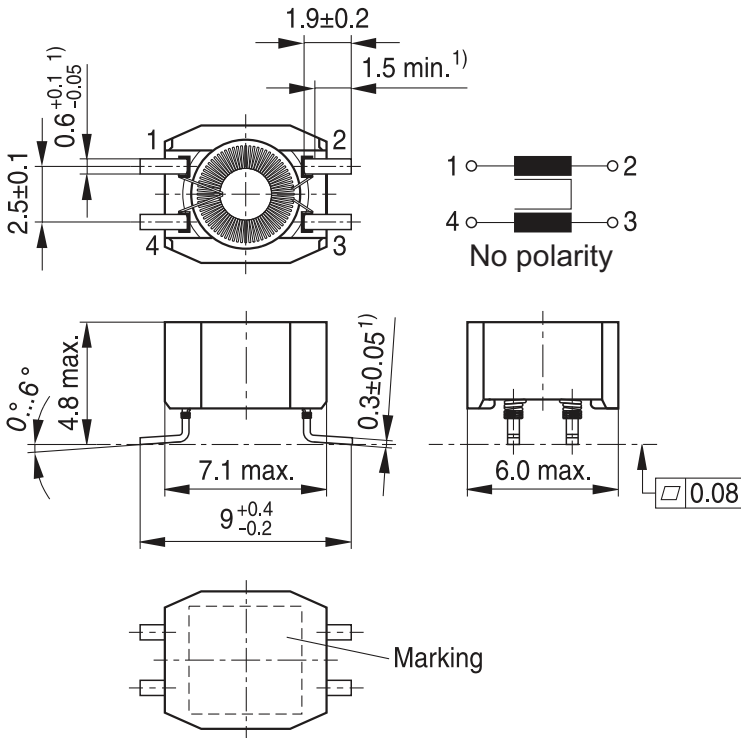

**Layout recommendation**

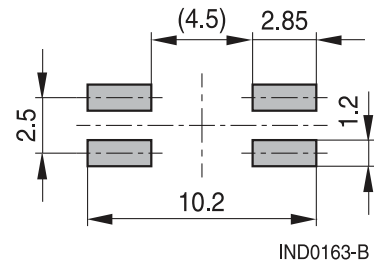

1) Soldering area

IND0010-9-E

Dimensions in mm

**Taping and packing**

Blister tape

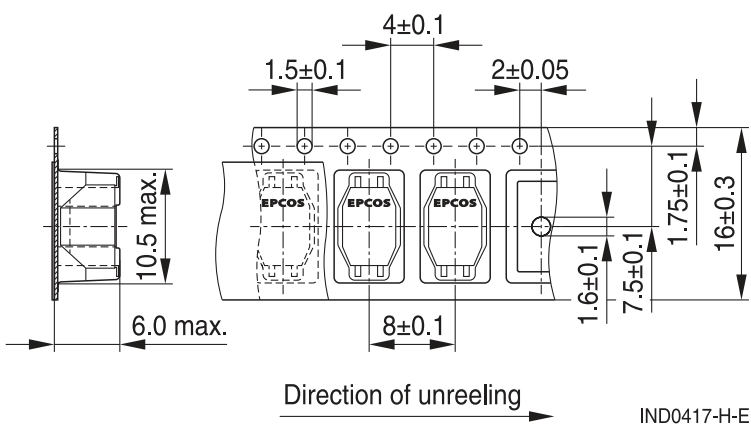

IND0417-H-E

Reel

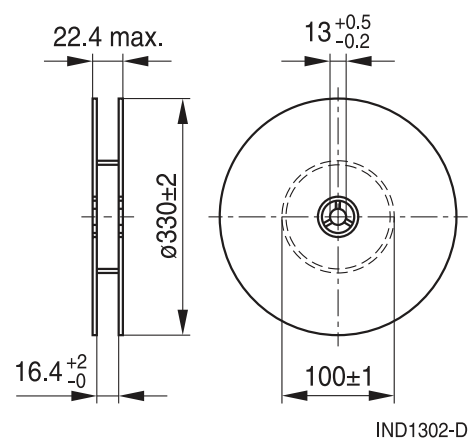

IND1302-D

Dimensions in mm

**SMD**
**Technical data and measuring conditions**

Rated voltage $V_R$	42 V AC (50/60 Hz) / 80 V DC
Rated temperature $T_R$	+60 °C
Rated current $I_R$	Referred to 50 Hz and rated temperature
Rated inductance $L_R$	Measured with Agilent 4284A, 0.1 mA, +20 °C Measuring frequency: $L_R \leq 1 \text{ mH} = 100 \text{ kHz}$ $L_R > 1 \text{ mH} = 10 \text{ kHz}$ Inductance is specified per winding.
Inductance tolerance	$\pm 30\%$ ( $L_R \leq 0.47 \text{ mH}$ ), $-30/+50\%$ ( $L_R \geq 1 \text{ mH}$ ) at +20 °C
Inductance decrease $\Delta L/L$	< 10% at DC magnetic bias with $I_R$ , +20 °C
Stray inductance $L_{\text{stray,typ}}$	Measured with Agilent 4284A, 5 mA, +20 °C, typical values Measuring frequency: $L_R \leq 11 \mu\text{H} = 1 \text{ MHz}$ $L_R > 11 \mu\text{H} = 100 \text{ kHz}$
DC resistance $R_{\text{typ}}$	Measured at +20 °C, typical values, specified per winding
Solderability	SnPb: $+(215 \pm 3) \text{ °C}$ , (3 $\pm$ 0.3) s Sn96.5Ag3.0Cu0.5: $+(245 \pm 5) \text{ °C}$ , (3 $\pm$ 0.3) s Wetting of soldering area $\geq 95\%$ (to IEC 60068-2-58)
Resistance to soldering heat	$+(260 \pm 5) \text{ °C}$ , (10 $\pm$ 1) s (to IEC 60068-2-58)
Climatic category	40/125/56 (to IEC 60068-1)
Storage conditions (packaged)	$-25 \text{ °C} \dots +40 \text{ °C}$ , $\leq 75\% \text{ RH}$
Weight	Approx. 0.25 g

**SMD**
**Characteristics and ordering codes**

$L_R$ mH	$L_{\text{stray,typ}}$ nH	$I_R$ mA	$R_{\text{typ}}$ m $\Omega$	$V_{\text{test}}$ V DC, 2 s	Ordering code
0.005	40	1200	60	250	B82793C0502N201
0.011	50	800	80	250	B82793C0113N201
0.025	60	800	110	250	B82793C0253N201
0.025	1400	800	110	250	B82793S0253N201
0.051	70	800	140	250	B82793C0513N201
0.051	2300	800	140	250	B82793S0513N201
0.10	100	500	180	250	B82793C0104N201
0.47	100	700	170	750	B82793C0474N215
1.0	70	700	140	750	B82793C0105N265
2.2	120	500	400	750	B82793C0225N265
4.7	250	400	550	750	B82793C0475N265
<b>For telecommunications</b>					
20	300	100	1800	750	B82793C0206N265
47	1200	100	3700	750	B82793C0476N265

**SMD**

Insertion loss  $\alpha$  (typical values at  $|Z| = 50 \Omega$ ,  $+20 \text{ }^\circ\text{C}$ )

———— asymmetrical, all branches in parallel (common mode)

- - - - - symmetrical (differential mode)

$L_R = 0.005 \text{ mH}$

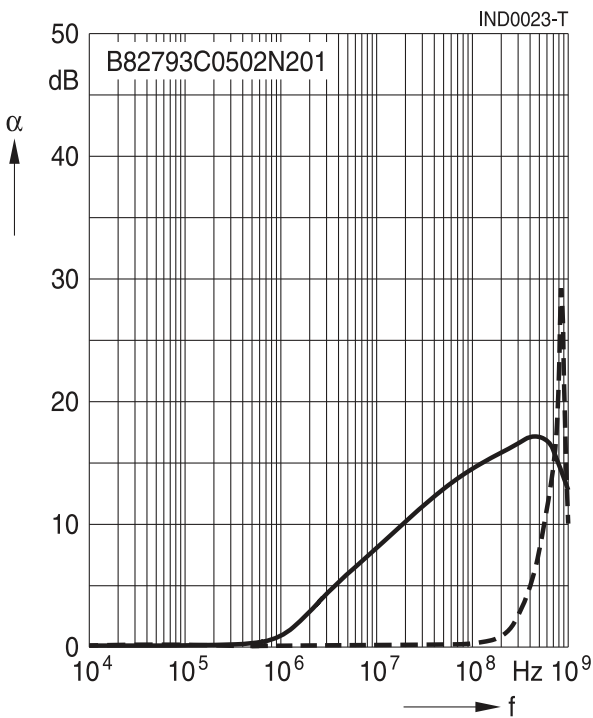

$L_R = 0.011 \text{ mH}$

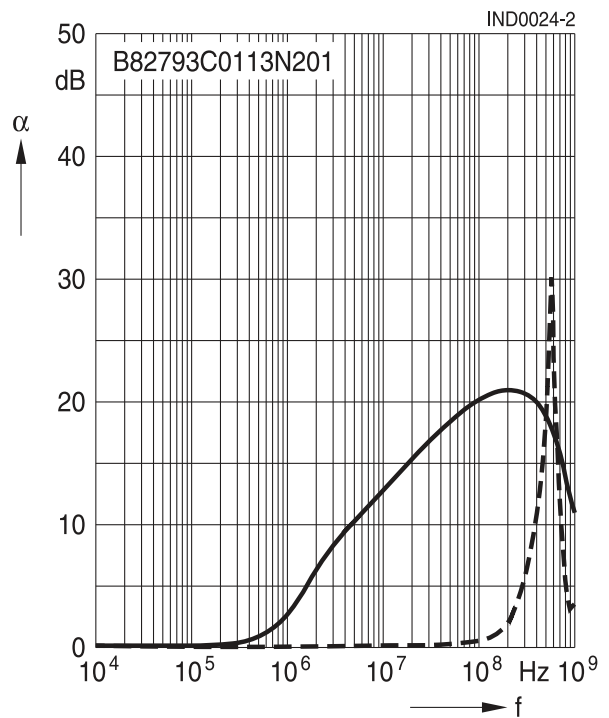

$L_R = 0.025 \text{ mH}$  (low  $L_{\text{stray}}$ )

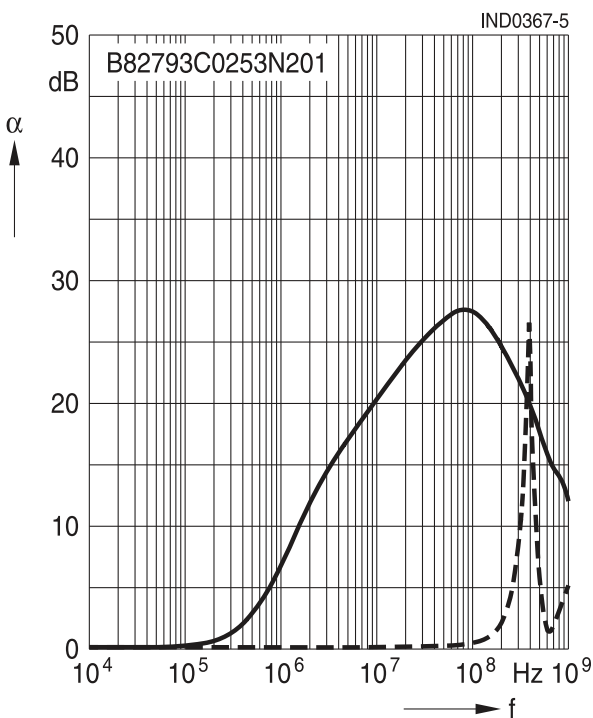

$L_R = 0.025 \text{ mH}$  (high  $L_{\text{stray}}$ )

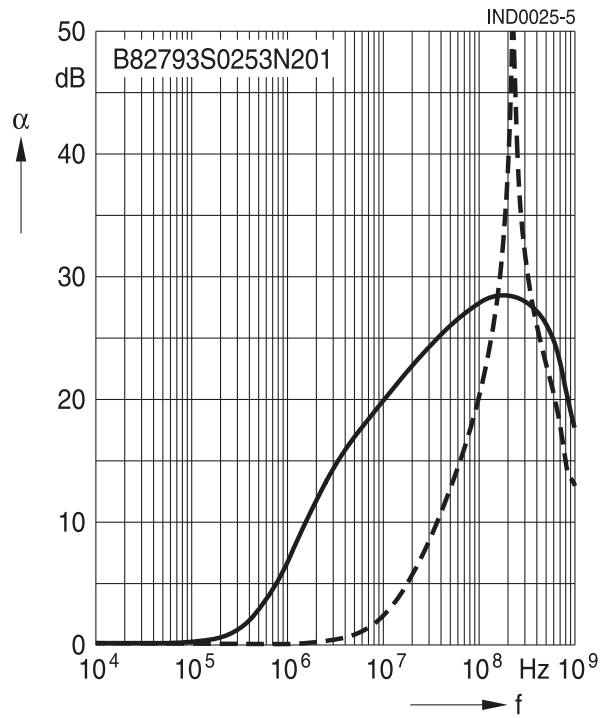

**SMD**

Insertion loss  $\alpha$  (typical values at  $|Z| = 50 \Omega$ ,  $+20 \text{ }^\circ\text{C}$ )

———— asymmetrical, all branches in parallel (common mode)

- - - - - symmetrical (differential mode)

$L_R = 0.051 \text{ mH}$  (low  $L_{\text{stray}}$ )

$L_R = 0.051 \text{ mH}$  (high  $L_{\text{stray}}$ )

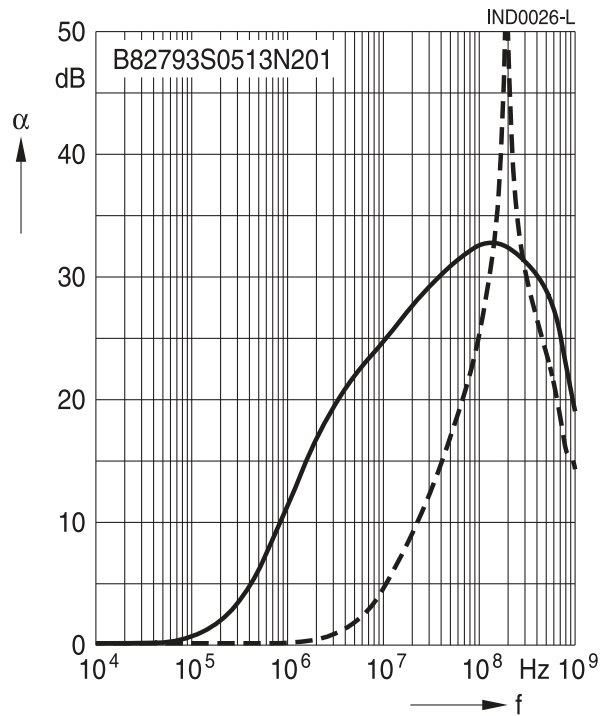
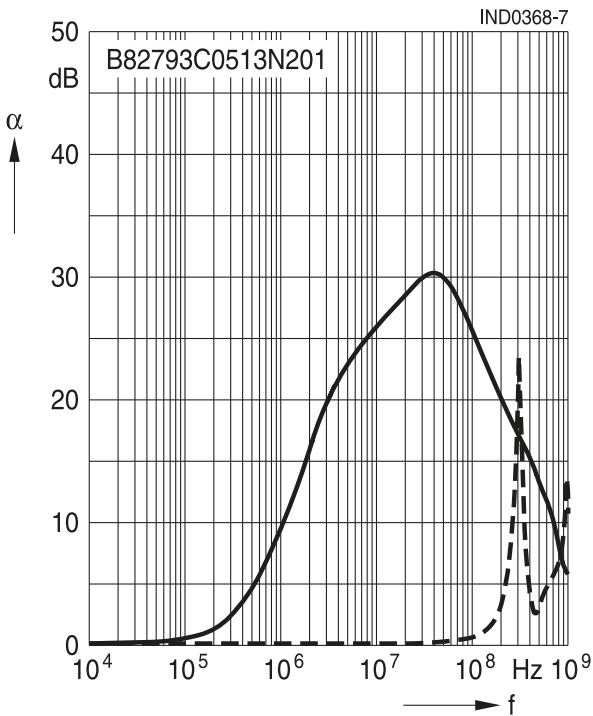

$L_R = 0.10 \text{ mH}$

$L_R = 0.47 \text{ mH}$

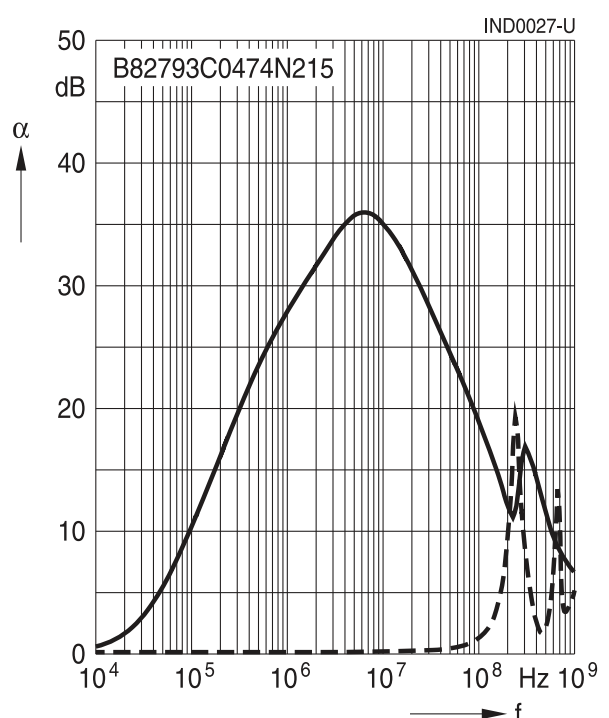
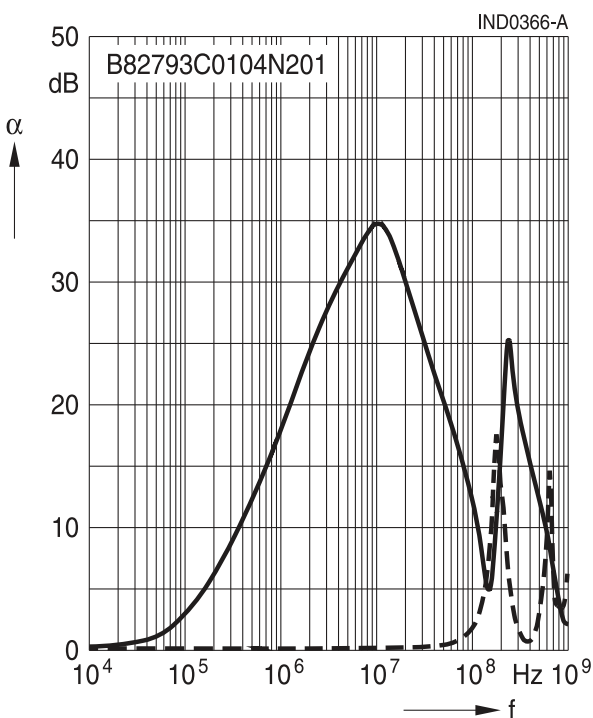

**SMD**

Insertion loss  $\alpha$  (typical values at  $|Z| = 50 \Omega$ ,  $+20 \text{ }^\circ\text{C}$ )

———— asymmetrical, all branches in parallel (common mode)

- - - - - symmetrical (differential mode)

$L_R = 1.0 \text{ mH}$

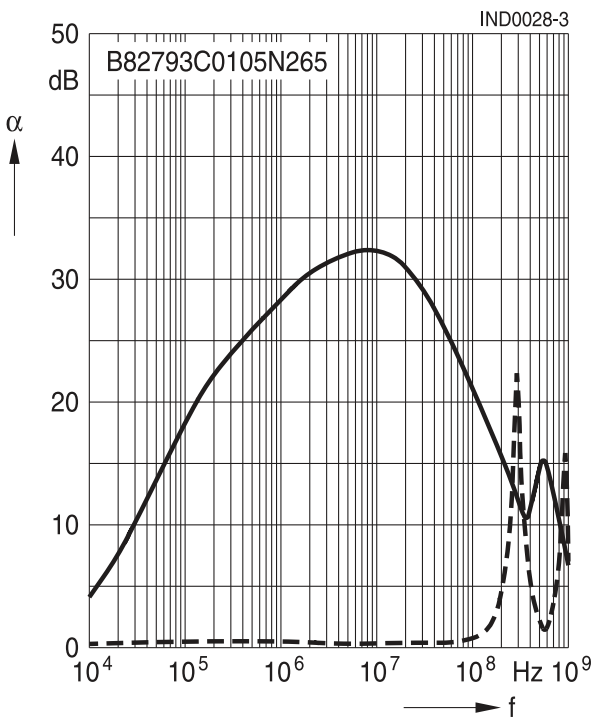

$L_R = 2.2 \text{ mH}$

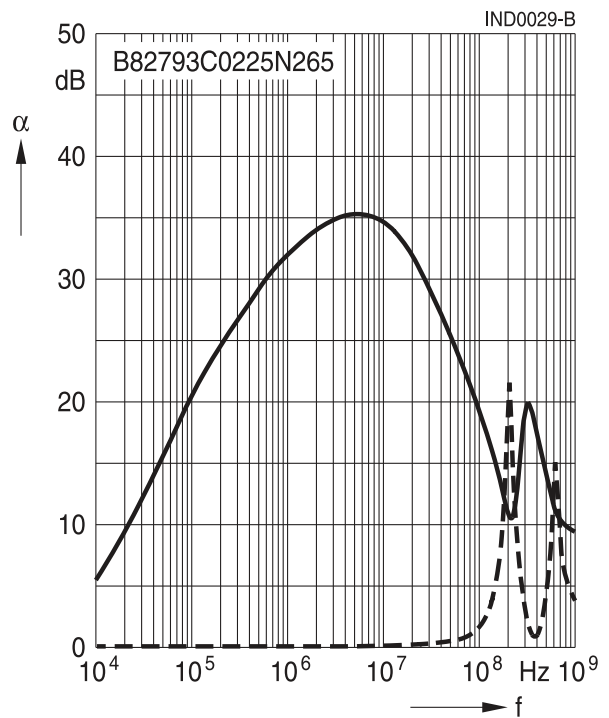

$L_R = 4.7 \text{ mH}$

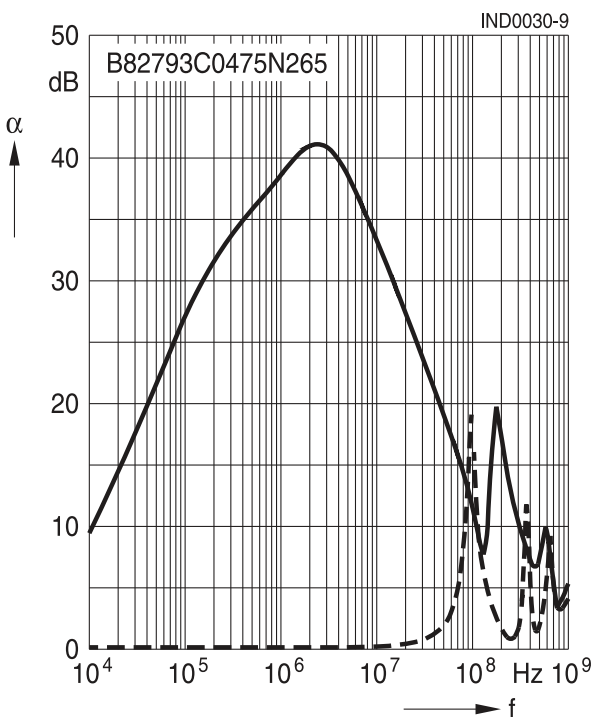

$L_R = 20 \text{ mH}$

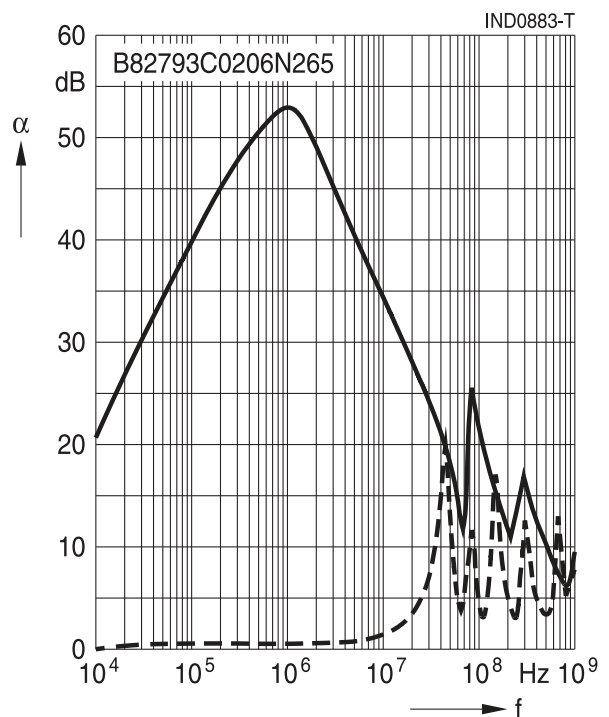

**SMD**

Insertion loss  $\alpha$  (typical values at  $|Z| = 50 \Omega$ ,  $+20^\circ\text{C}$ )

———— asymmetrical, all branches in parallel (common mode)

- - - - - symmetrical (differential mode)

$L_R = 47 \text{ mH}$

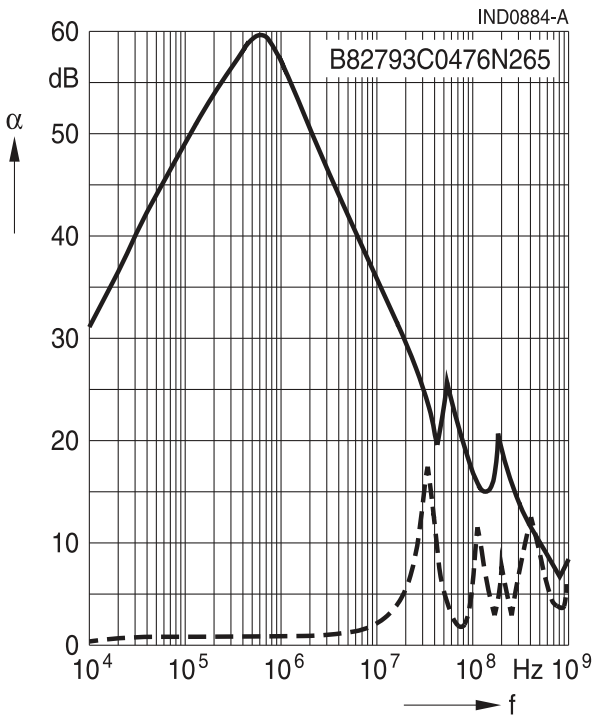

Current derating  $I_{op}/I_R$  versus ambient temperature

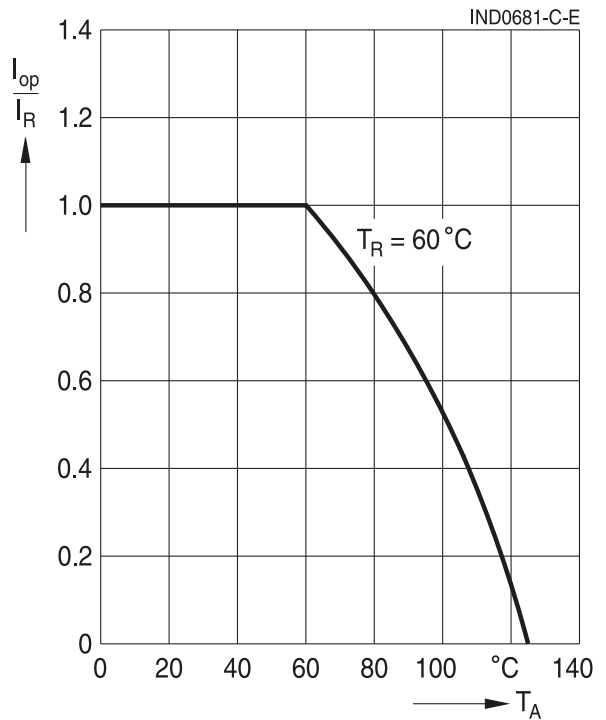

**SMD**

**Recommended reflow soldering curve**

Pb containing solder material (based on CECC 00802 edition 2)

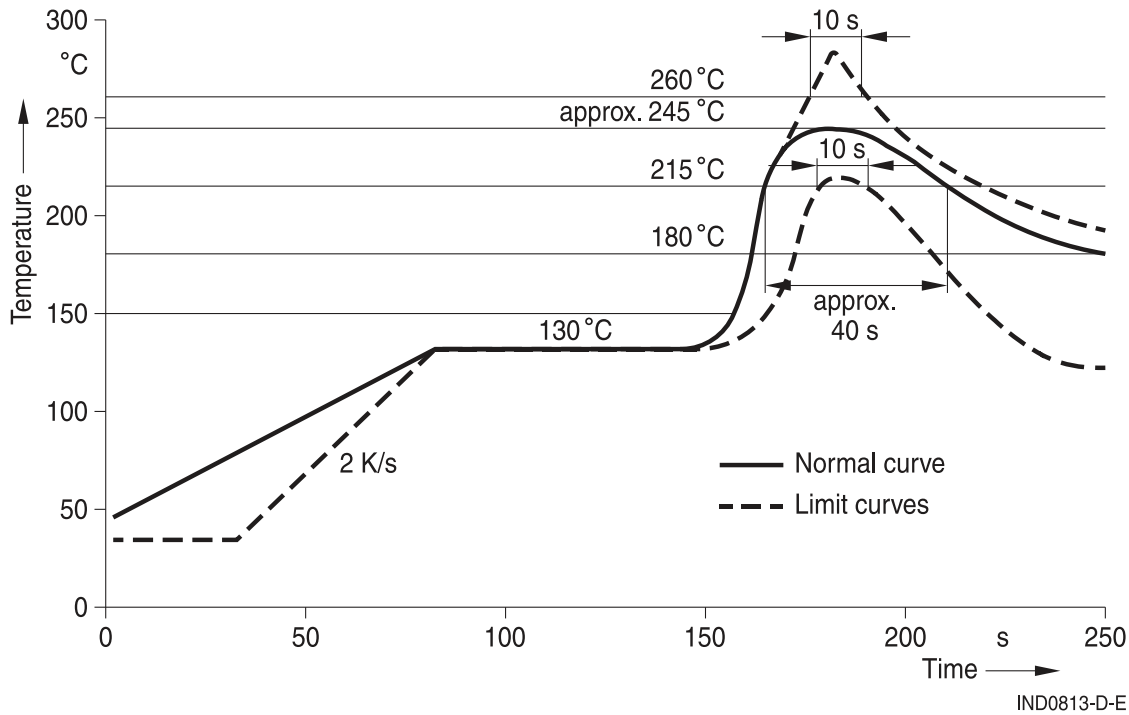

Pb-free solder material (based on JEDEC J-STD 020D)

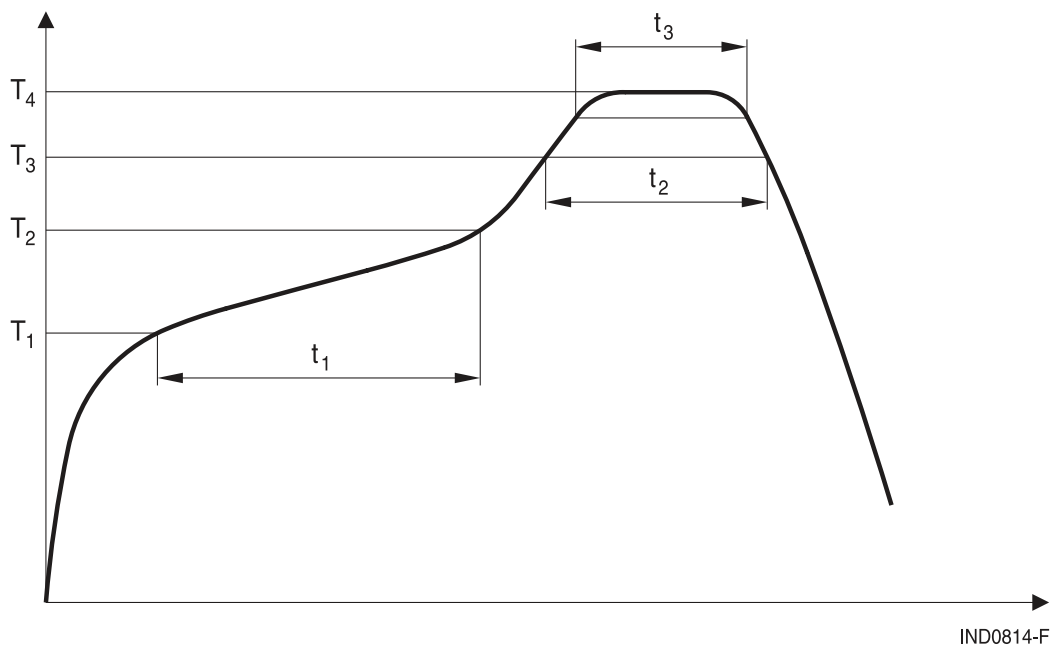

T <sub>1</sub> °C	T <sub>2</sub> °C	T <sub>3</sub> °C	T <sub>4</sub> °C	t <sub>1</sub> s	t <sub>2</sub> s	t <sub>3</sub> s
150	200	217	250	< 110	< 90	< 40 @ T <sub>4</sub> -5 °C

Time from +25 °C to T<sub>4</sub>: max 300 s  
 Maximal numbers of reflow cycles: 3

## Cautions and warnings

### SMD

- Please note the recommendations in our Inductors data book (latest edition) and in the data sheets.
  - Particular attention should be paid to the derating curves given there.
  - The soldering conditions should also be observed. Temperatures quoted in relation to wave soldering refer to the pin, not the housing.
- If the components are to be washed varnished it is necessary to check whether the washing varnish agent that is used has a negative effect on the wire insulation, any plastics that are used, or on glued joints. In particular, it is possible for washing varnish agent residues to have a negative effect in the long-term on wire insulation.  
Washing processes may damage the product due to the possible static or cyclic mechanical loads (e.g. ultrasonic cleaning). They may cause cracks to develop on the product and its parts, which might lead to reduced reliability or lifetime.
- The following points must be observed if the components are potted in customer applications:
  - Many potting materials shrink as they harden. They therefore exert a pressure on the plastic housing or core. This pressure can have a deleterious effect on electrical properties, and in extreme cases can damage the core or plastic housing mechanically.
  - It is necessary to check whether the potting material used attacks or destroys the wire insulation, plastics or glue.
  - The effect of the potting material can change the high-frequency behaviour of the components.
- Ferrites are sensitive to direct impact. This can cause the core material to flake, or lead to breakage of the core.
- Even for customer-specific products, conclusive validation of the component in the circuit can only be carried out by the customer.

### Display of ordering codes for EPCOS products

The ordering code for one and the same product can be represented differently in data sheets, data books, other publications and the website of EPCOS, or in order-related documents such as shipping notes, order confirmations and product labels. **The varying representations of the ordering codes are due to different processes employed and do not affect the specifications of the respective products.** Detailed information can be found on the Internet under [www.epcos.com/orderingcodes](http://www.epcos.com/orderingcodes).

## Important notes



The following applies to all products named in this publication:

1. Some parts of this publication contain **statements about the suitability of our products for certain areas of application**. These statements are based on our knowledge of typical requirements that are often placed on our products in the areas of application concerned. We nevertheless expressly point out **that such statements cannot be regarded as binding statements about the suitability of our products for a particular customer application**. As a rule we are either unfamiliar with individual customer applications or less familiar with them than the customers themselves. For these reasons, it is always ultimately incumbent on the customer to check and decide whether a product with the properties described in the product specification is suitable for use in a particular customer application.
2. We also point out that **in individual cases, a malfunction of electronic components or failure before the end of their usual service life cannot be completely ruled out in the current state of the art, even if they are operated as specified**. In customer applications requiring a very high level of operational safety and especially in customer applications in which the malfunction or failure of an electronic component could endanger human life or health (e.g. in accident prevention or life-saving systems), it must therefore be ensured by means of suitable design of the customer application or other action taken by the customer (e.g. installation of protective circuitry or redundancy) that no injury or damage is sustained by third parties in the event of malfunction or failure of an electronic component.
3. **The warnings, cautions and product-specific notes must be observed.**
4. In order to satisfy certain technical requirements, **some of the products described in this publication may contain substances subject to restrictions in certain jurisdictions (e.g. because they are classed as hazardous)**. Useful information on this will be found in our Material Data Sheets on the Internet ([www.tdk-electronics.tdk.com/material](http://www.tdk-electronics.tdk.com/material)). Should you have any more detailed questions, please contact our sales offices.
5. We constantly strive to improve our products. Consequently, **the products described in this publication may change from time to time**. The same is true of the corresponding product specifications. Please check therefore to what extent product descriptions and specifications contained in this publication are still applicable before or when you place an order.  
  
We also **reserve the right to discontinue production and delivery of products**. Consequently, we cannot guarantee that all products named in this publication will always be available. The aforementioned does not apply in the case of individual agreements deviating from the foregoing for customer-specific products.
6. Unless otherwise agreed in individual contracts, **all orders are subject to our General Terms and Conditions of Supply**.
7. **Our manufacturing sites serving the automotive business apply the IATF 16949 standard**. The IATF certifications confirm our compliance with requirements regarding the quality management system in the automotive industry. Referring to customer requirements and customer specific requirements ("CSR") TDK always has and will continue to have the policy of respecting individual agreements. Even if IATF 16949 may appear to support the acceptance of unilateral requirements, we hereby like to emphasize that **only requirements mutually agreed upon can and will be implemented in our Quality Management System**. For clarification purposes we like to point out that obligations from IATF 16949 shall only become legally binding if individually agreed upon.
8. The trade names EPCOS, CeraCharge, CeraDiode, CeraLink, CeraPad, CeraPlas, CSMP, CTVS, DeltaCap, DigiSiMic, ExoCore, FilterCap, FormFit, LeaXield, MiniBlue, MiniCell, MKD, MKK, MotorCap, PCC, PhaseCap, PhaseCube, PhaseMod, PhiCap, PowerHap, PQSine, PQvar, SIFERRIT, SIFI, SIKOREL, SilverCap, SIMDAD, SiMic, SIMID, SineFormer, SIOV, ThermoFuse, WindCap are **trademarks registered or pending** in Europe and in other countries. Further information will be found on the Internet at [www.tdk-electronics.tdk.com/trademarks](http://www.tdk-electronics.tdk.com/trademarks).

Release 2018-10

## Looking for pricing, stock, or lifecycle information?

Click below to explore more details on WIN SOURCE:

-  [View B82793C0253N201 on WIN SOURCE](#)
-  [EPCOS \(TDK\) Information](#)

## Optimize Your Supply Chain with WIN SOURCE Solutions

-  Global Sourcing Solution
-  Obsolete Management
-  Cost Control Management
-  Shortage Management
-  Alternative Solution
-  Excess Inventory Management