

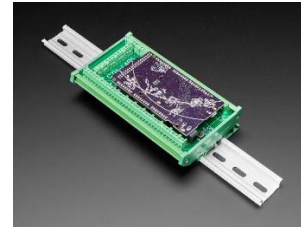

THE DATASHEET OF
4555

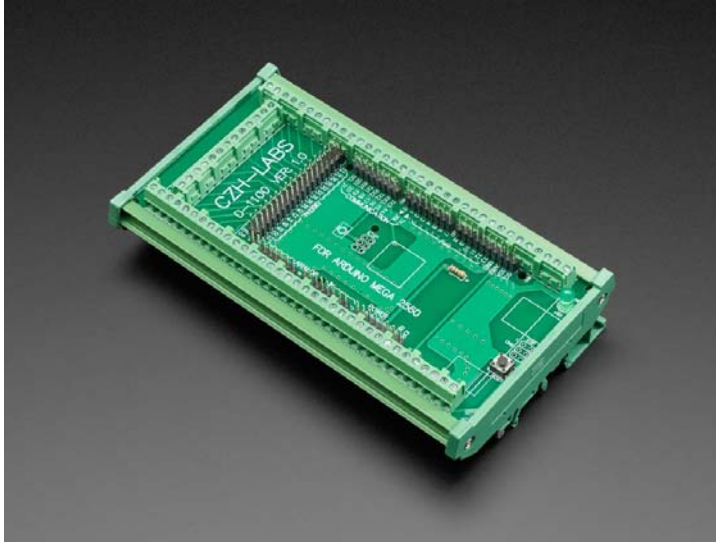



DIN Rail Terminal Block Adapter to Grand Central or Arduino Mega

PRODUCT ID: 4555

DESCRIPTION

This one's going out to all the makers and designers who use DIN riling in their builds. This adapter plate is perfect for simplifying complex wiring. You connect an Arduino Mega or Grand Central M4 Express to this breakout PCB, which can be DIN rail-mounted. All wires are broken out into terminal blocks, so you can connect and power your sensors, displays, microcontrollers, etc.

No soldering required! Place the microcontroller face-down onto the headers, unscrew the terminal blocks, and slide in your stranded or solid-core wire.

Note: DIN Rail and microcontroller are not included.

TECHNICAL DETAILS

- Overall dimensions (W x L x H): 153mm x 87mm x 45mm
- PCB Dimensions (W x L): 150mm x 72.5mm
- Pitch: 3.81mm/0.15" screw terminal block
- Terminal block wire range: 26–16AWG, strip length 5mm, M2 slotted screw

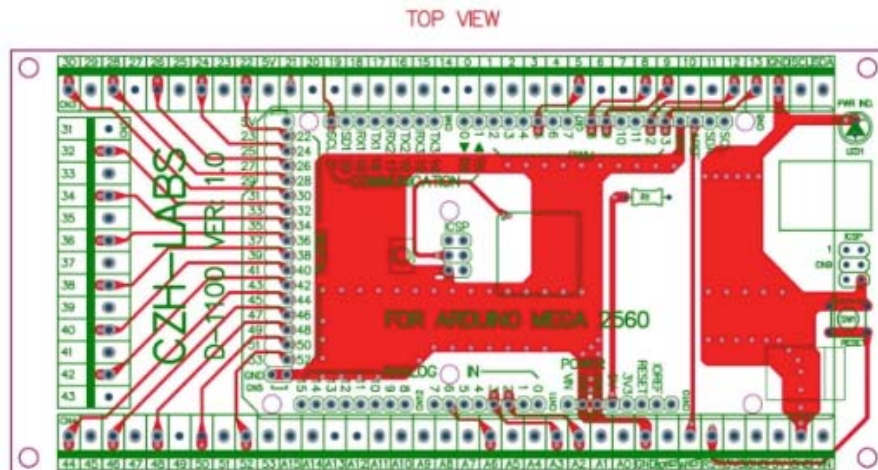
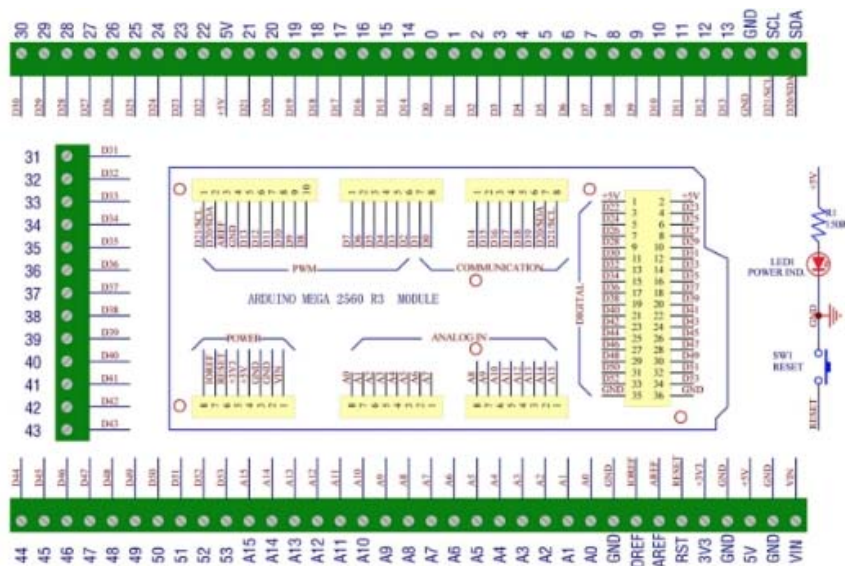
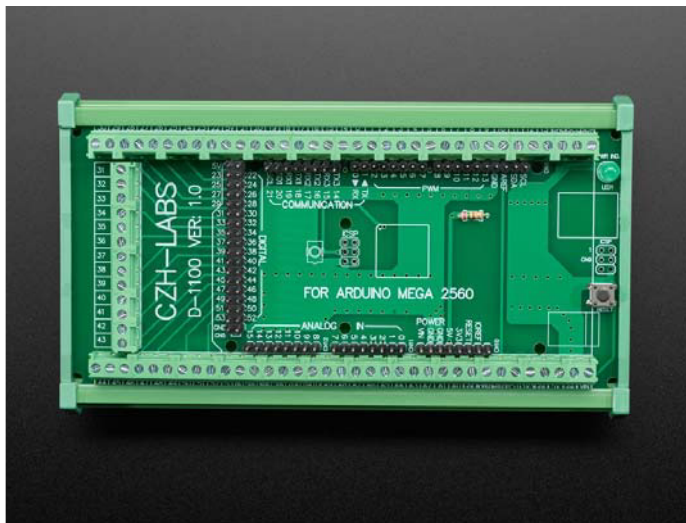

Diagram <https://cdn-shop.adafruit.com/product-files/4555/4555-diagram.png>





Pinout Diagram <https://cdn-shop.adafruit.com/product-files/4555/4555-pinout.png>



<https://www.adafruit.com/product/4555/3-23-20>

Looking for pricing, stock, or lifecycle information?

Click below to explore more details on WIN SOURCE:

-  [View 4555 on WIN SOURCE](#)
-  [Adafruit Industries LLC Information](#)

Optimize Your Supply Chain with WIN SOURCE Solutions

-  Global Sourcing Solution
-  Obsolete Management
-  Cost Control Management
-  Shortage Management
-  Alternative Solution
-  Excess Inventory Management