







**THE DATASHEET OF
PA1133NLT**

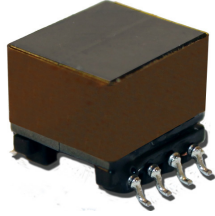

High Frequency Wire Wound Transformers

EP10 Platforms - SMT



-  Power Range: up to 30W
-  Height: 11.45mm Max
-  Footprint: 15.24mm x 13.1mm Max
-  Toplogy: Forward and Flyback

Electrical Specifications @ 25°C - Operating Temperature -40°C to +130°C

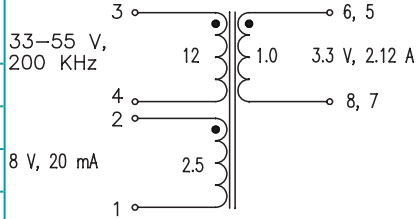
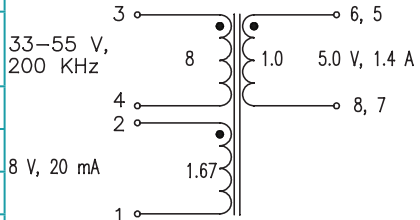
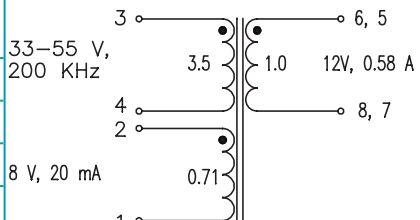
Part Number	Parameter	Configuration	Value	Notes
PA1133NL	Pri. Inductance	(3-4)	253.4µH ± 10%	 <p>FLYBACK TRANSFORMER</p>
	Lk. Inductance	(3-4) with (8, 7, 6, 5) shorted	7.5µH MAX	
	DCR	(3-4)	420mΩ MAX	
		(6, 5-8, 7)	7.5mΩ MAX	
	Hi-Pot	Pri-Sec	1500Vrms	
	K1 Factor		4671.8	
PA1134NL	Pri. Inductance	(3-4)	253.4µH ±10%	 <p>FLYBACK TRANSFORMER</p>
	Lk. Inductance	(3-4) with (8, 7, 6, 5) shorted	7.5µH MAX	
	DCR	(3-4)	420mΩ MAX	
		(6, 5-8, 7)	16mΩ MAX	
	Hi-Pot	Pri-Sec	1500Vrms	
	K1 Factor		4671.8	
PA1135NL	Pri. Inductance	(3-4)	264.1µH ±10%	 <p>FLYBACK TRANSFORMER</p>
	Lk. Inductance	(3-4) with (8, 7, 6, 5) shorted	6 µH MAX	
	DCR	(3-4)	800mΩ MAX	
		(6, 5-8, 7)	45mΩ MAX	
	Hi-Pot	Pri-Sec	1500Vrms	
	K1 Factor		4769.7	

High Frequency Wire Wound Transformers

EP10 Platforms - SMT

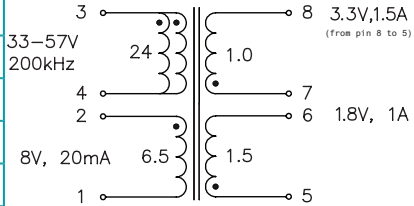
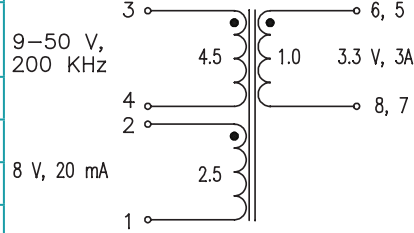
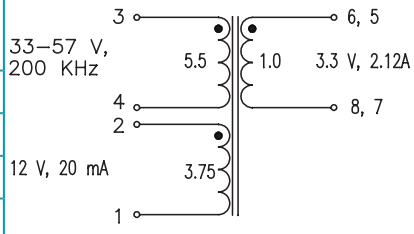
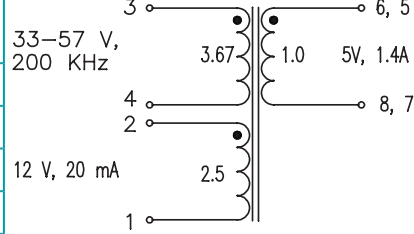
Electrical Specifications @ 25°C - Operating Temperature -40°C to +130°C				
PA1253NL	Pri. Inductance	(3-4)	253.4 μ H \pm 10%	 <p>33-57V 200kHz 8V, 20mA FLYBACK TRANSFORMER</p>
	Lk. Inductance	(3-4) with (8, 7, 6, 5) shorted	12 μ H MAX	
	DCR	(3-4)	420 m Ω MAX	
		(2-1)	335 m Ω MAX	
		(5-6)	9.5 m Ω MAX	
		(7-8)	7.2 m Ω MAX	
	Hi-Pot	Pri-Sec	1500Vrms	
KI Factor	4671.8			
PA1277NL	Pri. Inductance	(3-4)	20.4 μ H \pm 10%	 <p>9-50 V, 200 KHz 8 V, 20 mA FLYBACK TRANSFORMER</p>
	Lk. Inductance	(3-4) with (10, 9, 8, 7) shorted	1.5 μ H MAX	
	DCR	(3-4)	80 m Ω MAX	
		(6, 5-8, 7)	7.5 m Ω MAX	
		(2-1)	150 m Ω MAX	
	Hi-Pot	Pri-Sec	1500Vrms	
KI Factor	1002.9			
PA1282NL	Pri. Inductance	(3-4)	155 μ H \pm 10%	 <p>33-57 V, 200 KHz 12 V, 20 mA FLYBACK TRANSFORMER</p>
	Lk. Inductance	(3-4) with (8, 7, 6, 5) shorted	5 μ H MAX	
	DCR	(3-4)	530 m Ω MAX	
		(6, 5-8, 7)	31 m Ω MAX	
		(2-1)	900 m Ω MAX	
	Hi-Pot	Pri-Sec	1500Vrms	
KI Factor	3117.5			
PA1283NL	Pri. Inductance	(3-4)	155 μ H \pm 10%	 <p>33-57 V, 200 KHz 12 V, 20 mA FLYBACK TRANSFORMER</p>
	Lk. Inductance	(3-4) with (8, 7, 6, 5) shorted	5 μ H MAX	
	DCR	(3-4)	570 m Ω MAX	
		(6, 5-8, 7)	40 m Ω MAX	
		(2-1)	1000 m Ω MAX	
	Hi-Pot	Pri-Sec	1500 Vrms	
KI Factor	3117.5			

High Frequency Wire Wound Transformers

EP10 Platforms - SMT

Electrical Specifications @ 25°C - Operating Temperature -40°C to +130°C

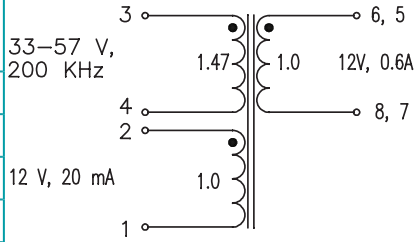
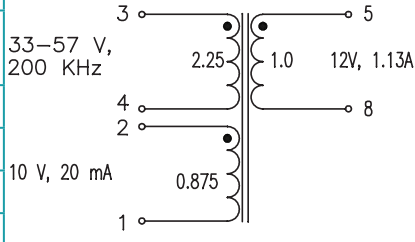
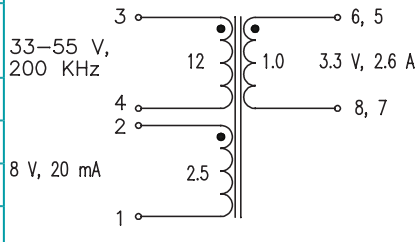
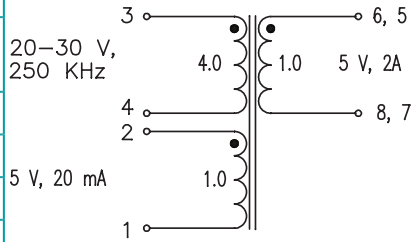
Part Number	Parameter	Configuration	Value	Notes
PA1284NL	Pri. Inductance	(3-4)	155 $\mu\text{H} \pm 10\%$	 <p>FLYBACK TRANSFORMER</p>
	Lk. Inductance	(3-4) with (8, 7, 6, 5) shorted	5 $\mu\text{H} \text{ MAX}$	
	DCR	(3-4)	540 $\text{m}\Omega \text{ MAX}$	
		(6, 5-8, 7)	370 $\text{m}\Omega \text{ MAX}$	
		(2-1)	920 $\text{m}\Omega \text{ MAX}$	
	Hi-Pot	Pri-Sec	1500 Vrms	
KI Factor		3117.5		
PA1370NL	Pri. Inductance	(3-4)	20.4 $\mu\text{H} \pm 10\%$	 <p>FLYBACK TRANSFORMER</p>
	Lk. Inductance	(3-4) with (8,5) shorted	1.5 $\mu\text{H} \text{ MAX}$	
	DCR	(3-4)	80 $\text{m}\Omega \text{ MAX}$	
		(5-8)	30 $\text{m}\Omega \text{ MAX}$	
		(2-1)	105 $\text{m}\Omega \text{ MAX}$	
	Hi-Pot	Pri-Sec	1500 Vrms	
KI Factor		1002.9		
PA1721NL	Pri. Inductance	(3-4)	185 $\mu\text{H} \pm 10\%$	 <p>FORWARD TRANSFORMER</p>
	Lk. Inductance	(3-4) with (8, 7, 6, 5) shorted	10 $\mu\text{H} \text{ MAX}$	
	DCR	(3-4)	420 $\text{m}\Omega \text{ MAX}$	
		(6, 5-8, 7)	12 $\text{m}\Omega \text{ MAX}$	
		(2-1)	115 $\text{m}\Omega \text{ MAX}$	
	Hi-Pot	Pri-Sec	1500 Vrms	
KI Factor		3410.8		
PA2362NL	Pri. Inductance	(3-4)	25.2 $\mu\text{H} \pm 10\%$	 <p>FLYBACK TRANSFORMER</p>
	Lk. Inductance	(3-4) with (1, 2, 8, 7, 6, 5) shorted	0.55 $\mu\text{H} \text{ MAX}$	
	DCR	(3-4)	135 $\text{m}\Omega \text{ MAX}$	
		(6, 5-8, 7)	11 $\text{m}\Omega \text{ MAX}$	
		(2-1)	115 $\text{m}\Omega \text{ MAX}$	
	Hi-Pot	Pri-Sec	1500 Vdc	
KI Factor		1115.0		

High Frequency Wire Wound Transformers

EP10 Platforms - SMT

Electrical Specifications @ 25°C - Operating Temperature -40°C to +130°C

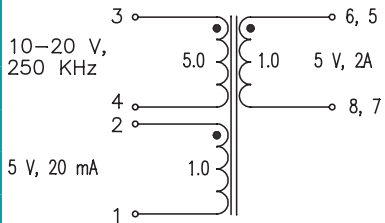
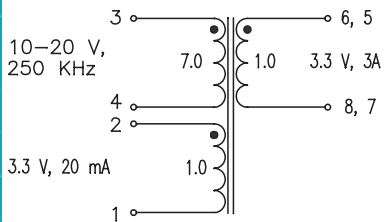
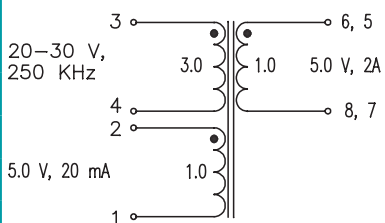
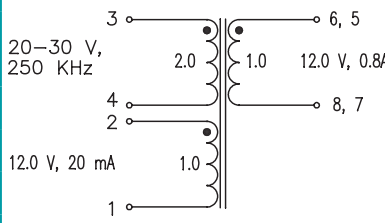
Model	Parameter	Configuration	Value	Notes
PA2363NL	Pri. Inductance	(3-4)	25.2 μ H \pm 10%	 <p>FLYBACK TRANSFORMER</p>
	Lk. Inductance	(3-4) with (1, 2, 8, 7, 6, 5) shorted	0.85 μ H MAX	
	DCR	(3-4)	135 m Ω MAX	
		(6, 5-8, 7)	9 m Ω MAX	
		(2-1)	180 m Ω MAX	
	Hi-Pot	Pri-Sec	1500 Vrms	
KI Factor		1115.0		
PA2364NL	Pri. Inductance	(3-4)	25.2 μ H \pm 10%	 <p>FLYBACK TRANSFORMER</p>
	Lk. Inductance	(3-4) with (1, 2, 8, 7, 6, 5) shorted	1 μ H MAX	
	DCR	(3-4)	145 m Ω MAX	
		(6, 5-8, 7)	7.5 m Ω MAX	
		(2-1)	110 m Ω MAX	
	Hi-Pot	Pri-Sec	1500 Vrms	
KI Factor		1059.4		
PA2454NL	Pri. Inductance	(3-4)	24 μ H \pm 10%	 <p>FLYBACK TRANSFORMER</p>
	Lk. Inductance	(3-4) with (8, 7, 6, 5) shorted	0.75 μ H MAX	
	DCR	(3-4)	82 m Ω MAX	
		(6, 5-8, 7)	13 m Ω MAX	
		(2-1)	80 m Ω MAX	
	Hi-Pot	Pri-Sec	1500 Vrms	
KI Factor		1179.9		
PA2455NL	Pri. Inductance	(3-4)	24 μ H \pm 10%	 <p>FLYBACK TRANSFORMER</p>
	Lk. Inductance	(1-4) with (8, 7, 6, 5) shorted	0.6 μ H MAX	
	DCR	(3-4)	90 m Ω MAX	
		(6, 5-8, 7)	23 m Ω MAX	
		(2-1)	130 m Ω MAX	
	Hi-Pot	Pri-Sec	1500 Vdc	
KI Factor		1179.9		

High Frequency Wire Wound Transformers

EP10 Platforms - SMT

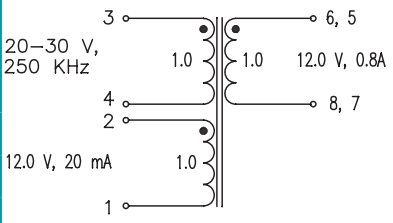
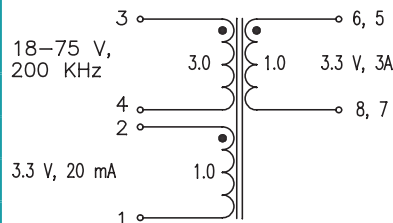
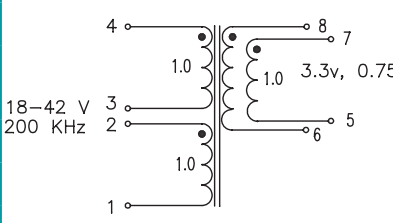
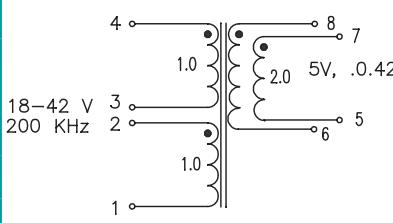
Electrical Specifications @ 25°C - Operating Temperature -40°C to +130°C					
PA2456NL	Pri. Inductance	(3-4)	24 μ H \pm 10%		FLYBACK TRANSFORMER
	Lk. Inductance	(3,4) with (8, 7, 6, 5) shorted	0.6 μ H MAX		
	DCR	(3-4)	86 m Ω MAX		
		(6, 5-8, 7)	86 m Ω MAX		
		(2-1)	470 m Ω MAX		
	Hi-Pot	Pri-Sec	1500 Vrms		
KI Factor	1179.9				
PA2627NL	Pri. Inductance	(3-4)	50.5 μ H \pm 10%		FLYBACK TRANSFORMER
	Lk. Inductance	(3-4) with (8, 7, 6, 5) shorted	1.4 μ H MAX		
	DCR	(3-4)	420 m Ω MAX		
		(6, 5-8, 7)	47 m Ω MAX		
		(2-1)	174 m Ω MAX		
	Hi-Pot	Pri-Sec	1500 Vrms		
KI Factor	1241.4				
PA3948.001NL	Pri. Inductance	(4-1) with 3,2 shorted	40 μ H \pm 10%		FLYBACK TRANSFORMER
		(4-1) with 3,2 shorted	32 μ H Min at 1.88A		
	Lk. Inductance	(4-1) with (5, 6, 7, 8) shorted	1.45 μ H MAX		
	DCR	(3-4)	410 m Ω MAX		
		(6, 5-8, 7)	140 m Ω MAX		
		(2-1)	140 m Ω MAX		
Hi-Pot	Pri-Sec	1500 Vdc			
KI Factor	1241.4				
PA3948.002NL	Pri. Inductance	(4-1) with 3,2 shorted	40 μ H \pm 10%		FLYBACK TRANSFORMER
		(4-1) with 3,2 shorted	32 μ H Min at 1.88A		
	Lk. Inductance	(4-1) with (5, 6, 7, 8) shorted	1.45 μ H MAX		
	DCR	(4-1)	405 m Ω MAX		
		(8-6)	470 m Ω MAX		
		(7-5)	470 m Ω MAX		
Hi-Pot	Pri-Sec	1500 Vdc			
KI Factor	983.3				

High Frequency Wire Wound Transformers

EP10 Platforms - SMT

Electrical Specifications @ 25°C - Operating Temperature -40°C to +130°C

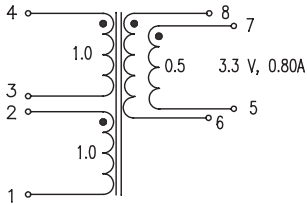
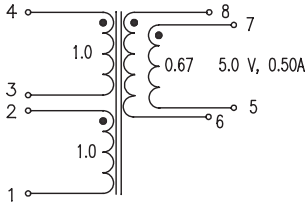
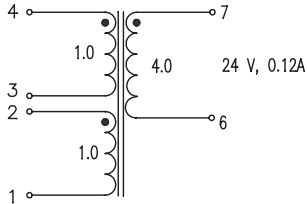
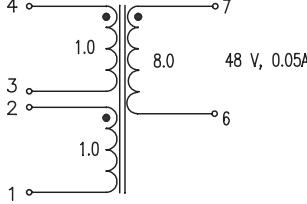
Part Number	Parameter	Configuration	Value	Notes	Diagram
PA3948.003NL	Pri. Inductance	(4-1) with 3, 2 shorted	40 μ H \pm 10%	8-36 V 200 KHz	
		(4-1) with 3, 2 shorted	32 μ H Min at 1.88A		
	Lk. Inductance	(4-1) with (5, 6, 7, 8) shorted	1.45 μ H MAX		
	DCR	(4-1)	405 m Ω MAX		
		(8-6)	470 m Ω MAX		
	Hi-Pot	Pri-Sec	1500 Vrms		
K1 Factor	983.3				
PA3948.004NL	Pri. Inductance	(4-1) with 3, 2 shorted	40 μ H \pm 10%	8-36 V 200 KHz	
		(4-1) with 3, 2 shorted	32 μ H Min at 1.88A		
	Lk. Inductance	(4-1) with (5, 6, 7, 8) shorted	1.45 μ H MAX		
	DCR	(4-1)	220 m Ω MAX		
		(8-6)	58 m Ω MAX		
	Hi-Pot	Pri-Sec	1500 Vrms		
K1 Factor	983.3				
PA3948.005NL	Pri. Inductance	(4-1) with 3, 2 shorted	40 μ H \pm 10%	8-36 V 200 KHz	
		(4-1) with 3, 2 shorted	32 μ H Min at 1.88A		
	Lk. Inductance	(4-1) with (5, 6, 7, 8) shorted	1.6 μ H MAX		
	DCR	(4-1)	220 m Ω MAX		
		(7-6)	1275 m Ω MAX		
	Hi-Pot	Pri-Sec	1500 Vrms		
K1 Factor	983.3				
PA3948.006NL	Pri. Inductance	(4-1) with 3, 2 shorted	40 μ H \pm 10%	8-36 V 200 KHz	
		(4-1) with 3, 2 shorted	32 μ H Min at 1.88A		
	Lk. Inductance	(4-1) with (5, 6, 7, 8) shorted	1.65 μ H MAX		
	DCR	(4-1)	220 m Ω MAX		
		(7-6)	3350 m Ω MAX		
	Hi-Pot	Pri-Sec	1500 Vrms		
K1 Factor	983.3				

High Frequency Wire Wound Transformers

EP10 Platforms - SMT

Notes:

1. The temperature of the component (ambient plus temperature rise) must be within the stated operating temperature range.
2. The above transformers and inductors have been tested and approved by Pulse's power IC partners and are sited in the appropriate datasheet or evaluation board documentation at these companies. To determine which IC and IC partners are matched with the above Pulse part numbers please consult the IC Cross Reference on the Pulse website.
3. For flyback topology applications, it is necessary to ensure that the transformer will not saturate in the application. The peak flux density (Bpk) should remain below 2700Gauss. To calculate the peak density, use the following formula:

$$B_{pk} \text{ (Gauss)} = K1_Factor * I_{pk} \text{ (A)}$$
4. In high volt-sec applications, it is important to calculate the core loss of the transformer. Approximate transformer core loss can be calculated as:

$$CoreLoss \text{ (W)} = 2.5E-14 * (Freq_kHz)^{1.63} * (\Delta B_Gauss)^{2.63}$$
 where ΔB can be calculated as:
 For Flyback Topology: $\Delta B = K1_Factor * (A)$
 For Forward Topology: $\Delta B = K1_Factor * Volt\text{-}\mu\text{sec}$
5. Optional Tape & Reel packaging can be ordered by adding a "T" suffix to the part number (i.e. PA1136NL becomes PA1136NLT). Pulse complies with industry standard tape and reel specification EIA481. The tape and reel for this product has a width (W=32mm), pitch (Po=24mm) and a depth (Ko=13.2mm).

Mechanical

PAXXXNL

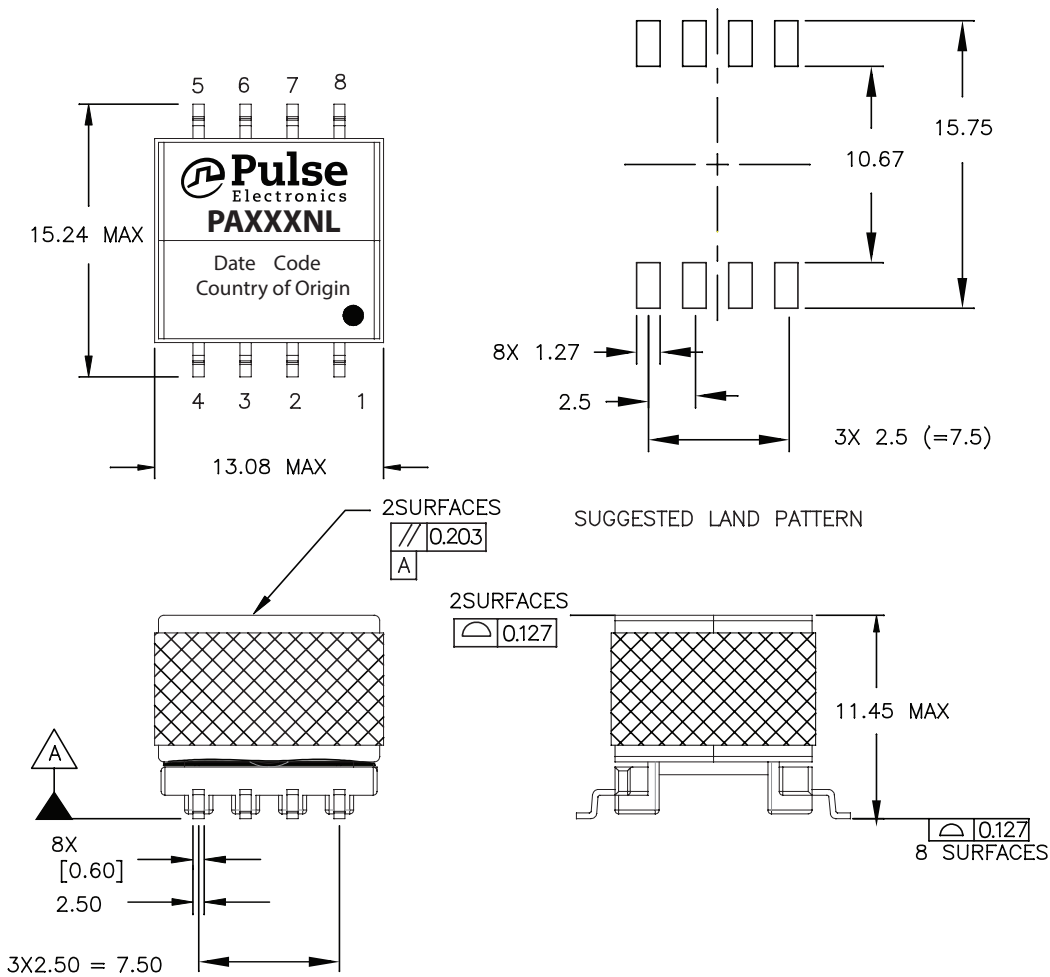

For More Information

Americas - prodinfo_power_americas@yageo.com | Europe - prodinfo_power_emea@yageo.com | Asia - prodinfo_power_asia@yageo.com

Performance warranty of products offered on this data sheet is limited to the parameters specified. Data is subject to change without notice. Other brand and product names mentioned herein may be trademarks or registered trademarks of their respective owners. © Copyright, 2023. Pulse Electronics, Inc. All rights reserved.

YAGEO Corporation and its affiliates do not recommend the use of commercial or automotive grade products for high reliability applications or manned space flight.

High Frequency Wire Wound Transformers

EP10 Platforms - SMT

Looking for pricing, stock, or lifecycle information?

Click below to explore more details on WIN SOURCE:

 [View PA1133NLT on WIN SOURCE](#)

 [Pulse Information](#)

Optimize Your Supply Chain with WIN SOURCE Solutions

-  Global Sourcing Solution
-  Obsolete Management
-  Cost Control Management
-  Shortage Management
-  Alternative Solution
-  Excess Inventory Management