

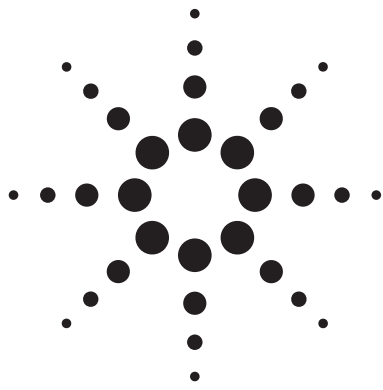

THE DATASHEET OF AT-41435G





Agilent AT-41435 Up to 6 GHz Low Noise Silicon Bipolar Transistor

Data Sheet

Description

Agilent's AT-41435 is a general purpose NPN bipolar transistor that offers excellent high frequency performance. The AT-41435 is housed in a cost effective surface mount 100 mil micro-X package. The 4 micron emitter-to-emitter pitch enables this transistor to be used in many different functions. The 14 emitter finger interdigitated geometry yields an intermediate sized transistor with impedances that are easy to match for low noise and moderate power applications. This device is designed for use in low noise, wideband amplifier, mixer and oscillator applications in the VHF, UHF, and microwave frequencies. An optimum noise match near 50Ω at 1 GHz, makes this device easy to use as a low noise amplifier.

35 micro-X Package

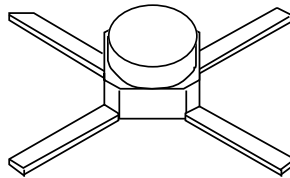

The AT-41435 bipolar transistor is fabricated using Agilent's 10 GHz f_T Self-Aligned-Transistor (SAT) process. The die is nitride passivated for surface protection. Excellent device uniformity, performance and reliability are produced by the use of ion-implantation, self-alignment techniques, and gold metalization in the fabrication of this device.

Features

- **Low Noise Figure:**
1.7 dB Typical at 2.0 GHz
3.0 dB Typical at 4.0 GHz
- **High Associated Gain:**
14.0 dB Typical at 2.0 GHz
10.0 dB Typical at 4.0 GHz
- **High Gain-Bandwidth Product:** 8.0 GHz Typical f_T
- **Cost Effective Ceramic Microstrip Package**
- **Lead-free Option Available**



AT-41435 Absolute Maximum Ratings

Symbol	Parameter	Units	Absolute Maximum ^[1]
V _{EBO}	Emitter-Base Voltage	V	1.5
V _{CBO}	Collector-Base Voltage	V	20
V _{CEO}	Collector-Emitter Voltage	V	12
I _C	Collector Current	mA	60
P _T	Power Dissipation ^[2,3]	mW	500
T _j	Junction Temperature	°C	150
T _{STG}	Storage Temperature ^[4]	°C	-65 to 150

Thermal Resistance^[2,5]:

$$\theta_{jc} = 200^{\circ}\text{C/W}$$

Notes:

1. Permanent damage may occur if any of these limits are exceeded.
2. T_{CASE} = 25°C.
3. Derate at 5 mW/°C for T_C > 100°C.
4. Storage above +150°C may tarnish the leads of this package making it difficult to solder into a circuit.
5. The small spot size of this technique results in a higher, though more accurate determination of θ_{jc} than do alternate methods. See MEASUREMENTS section “Thermal Resistance” for more information.

Electrical Specifications, T_A = 25°C

Symbol	Parameters and Test Conditions	Units	Min.	Typ.	Max.
S _{21E} ²	Insertion Power Gain; V _{CE} = 8 V, I _C = 25 mA	f = 2.0 GHz f = 4.0 GHz	dB	11.5 6.0	
P _{1dB}	Power Output @ 1 dB Gain Compression V _{CE} = 8 V, I _C = 25 mA	f = 2.0 GHz f = 4.0 GHz	dBm	19.0 18.5	
G _{1dB}	1 dB Compressed Gain; V _{CE} = 8 V, I _C = 25 mA	f = 2.0 GHz f = 4.0 GHz	dB	14.0 9.5	
NF _O	Optimum Noise Figure; V _{CE} = 8 V, I _C = 10 mA	f = 1.0 GHz f = 2.0 GHz f = 4.0 GHz	dB	1.3 1.7 3.0	2.0
G _A	Gain @ NF _O ; V _{CE} = 8 V, I _C = 10 mA	f = 1.0 GHz f = 2.0 GHz f = 4.0 GHz	dB	13.0 18.5 14.0 10.0	
f _T	Gain Bandwidth Product; V _{CE} = 8 V, I _C = 25 mA		GHz	8.0	
h _{FE}	Forward Current Transfer Ratio; V _{CE} = 8 V, I _C = 10 mA		—	30	270
I _{CBO}	Collector Cutoff Current; V _{CB} = 8 V		μA		0.2
I _{EBO}	Emitter Cutoff Current; V _{EB} = 1 V		μA		1.0
C _{CB}	Collector Base Capacitance ^[1] ; V _{CB} = 8 V, f = 1 MHz		pF	0.2	

Note:

1. For this test, the emitter is grounded.

AT-41435 Typical Performance, $T_A = 25^\circ\text{C}$

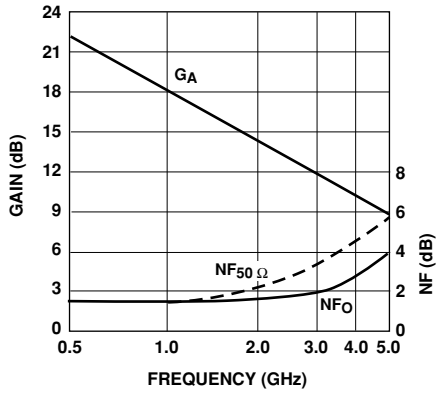

Figure 1. Noise Figure and Associated Gain vs. Frequency.
 $V_{CE} = 8\text{ V}$, $I_C = 10\text{ mA}$.

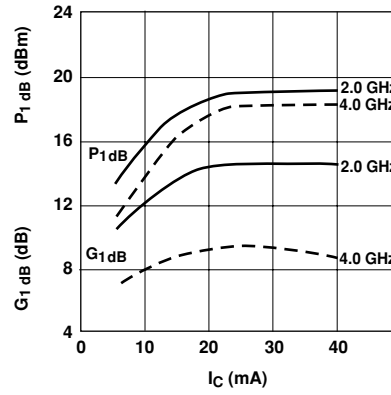

Figure 2. Output Power and 1 dB Compressed Gain vs. Collector Current and Frequency. $V_{CE} = 8\text{ V}$.

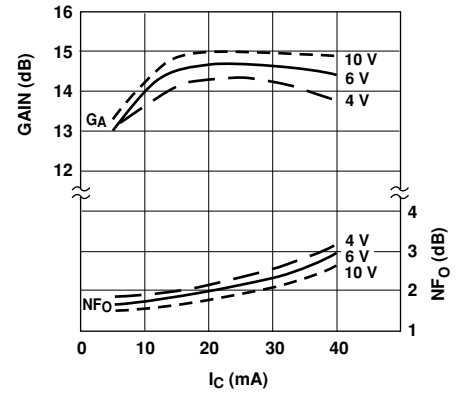

Figure 3. Optimum Noise Figure and Associated Gain vs. Collector Current and Collector Voltage. $f = 2.0\text{ GHz}$.

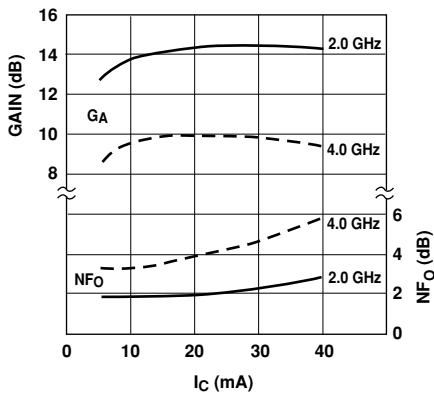

Figure 4. Optimum Noise Figure and Associated Gain vs. Collector Current and Frequency. $V_{CE} = 8\text{ V}$.

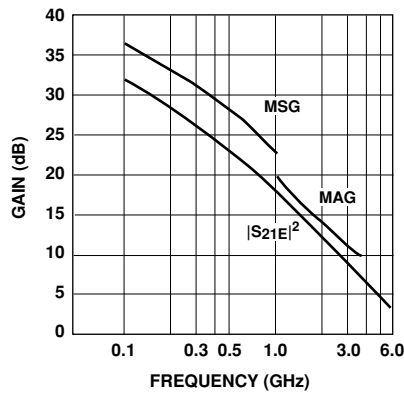

Figure 5. Insertion Power Gain, Maximum Available Gain and Maximum Stable Gain vs. Frequency.
 $V_{CE} = 8\text{ V}$, $I_C = 25\text{ mA}$.

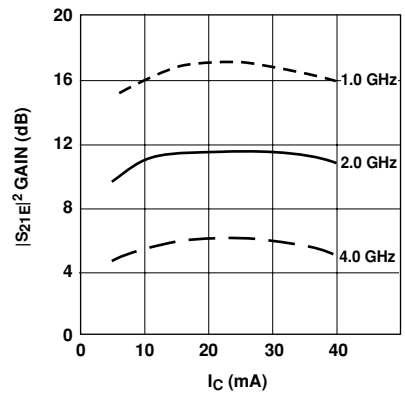

Figure 6. Insertion Power Gain vs. Collector Current and Frequency.
 $V_{CE} = 8\text{ V}$.

AT-41435 Typical Scattering Parameters,Common Emitter, $Z_O = 50 \Omega$, $T_A = 25^\circ\text{C}$, $V_{CE} = 8 \text{ V}$, $I_C = 10 \text{ mA}$

Freq. GHz	S_{11}		dB	S_{21}		dB	S_{12}		S_{22}	
	Mag.	Ang.		Mag.	Ang.		Mag.	Ang.	Mag.	Ang.
0.1	.80	-32	28.0	24.99	157	-39.2	.011	82	.93	-12
0.5	.50	-110	21.8	12.30	108	-29.6	.033	52	.61	-28
1.0	.40	-152	16.6	6.73	85	-26.2	.049	56	.51	-30
1.5	.38	-176	13.3	4.63	71	-24.0	.063	59	.48	-32
2.0	.39	166	11.0	3.54	60	-21.9	.080	58	.46	-37
2.5	.41	156	9.3	2.91	53	-20.4	.095	61	.44	-40
3.0	.44	145	7.9	2.47	43	-18.8	.115	61	.43	-48
3.5	.46	137	6.7	2.15	33	-17.5	.133	58	.43	-58
4.0	.46	127	5.6	1.91	23	-16.0	.153	53	.45	-68
4.5	.47	116	4.7	1.72	13	-15.0	.178	50	.46	-75
5.0	.49	104	4.0	1.58	3	-13.9	.201	47	.48	-82
5.5	.52	91	3.3	1.45	-7	-13.0	.224	40	.47	-89
6.0	.59	81	2.5	1.34	-17	-12.1	.247	36	.43	-101

AT-41435 Typical Scattering Parameters,Common Emitter, $Z_O = 50 \Omega$, $T_A = 25^\circ\text{C}$, $V_{CE} = 8 \text{ V}$, $I_C = 25 \text{ mA}$

Freq. GHz	S_{11}		dB	S_{21}		dB	S_{12}		S_{22}	
	Mag.	Ang.		Mag.	Ang.		Mag.	Ang.	Mag.	Ang.
0.1	.63	-50	31.8	39.08	146	-40.0	.010	83	.84	-18
0.5	.39	-137	22.9	13.97	99	-31.4	.027	60	.50	-26
1.0	.36	-171	17.2	7.28	80	-27.1	.044	67	.45	-26
1.5	.36	171	13.9	4.94	68	-23.5	.067	66	.43	-30
2.0	.38	156	11.5	3.76	58	-21.6	.083	63	.41	-34
2.5	.40	149	9.8	3.08	52	-19.6	.105	63	.39	-38
3.0	.43	140	8.3	2.61	43	-18.3	.122	64	.38	-47
3.5	.45	132	7.2	2.28	33	-16.8	.144	59	.39	-57
4.0	.46	122	6.1	2.02	23	-15.6	.165	55	.40	-67
4.5	.46	112	5.2	1.82	14	-14.6	.185	50	.42	-75
5.0	.47	101	4.4	1.66	4	-13.7	.207	45	.43	-81
5.5	.51	89	3.7	1.54	-5	-12.6	.233	39	.42	-89
6.0	.58	79	3.0	1.41	-15	-11.8	.257	33	.37	-101

A model for this device is available in the DEVICE MODELS section.

AT-41435 Noise Parameters: $V_{CE} = 8 \text{ V}$, $I_C = 10 \text{ mA}$

Freq. GHz	NF_O dB	Γ_{opt}		$R_N/50$
		Mag	Ang	
0.1	1.2	.12	3	0.17
0.5	1.2	.10	14	0.17
1.0	1.3	.05	28	0.17
2.0	1.7	.30	-154	0.16
4.0	3.0	.54	-118	0.35

Ordering Information

Part Numbers	No. of Devices
AT-41435	10
AT-41435G	10

Note: Order part number with a "G" suffix if lead-free option is desired.

35 micro-X Package Dimensions

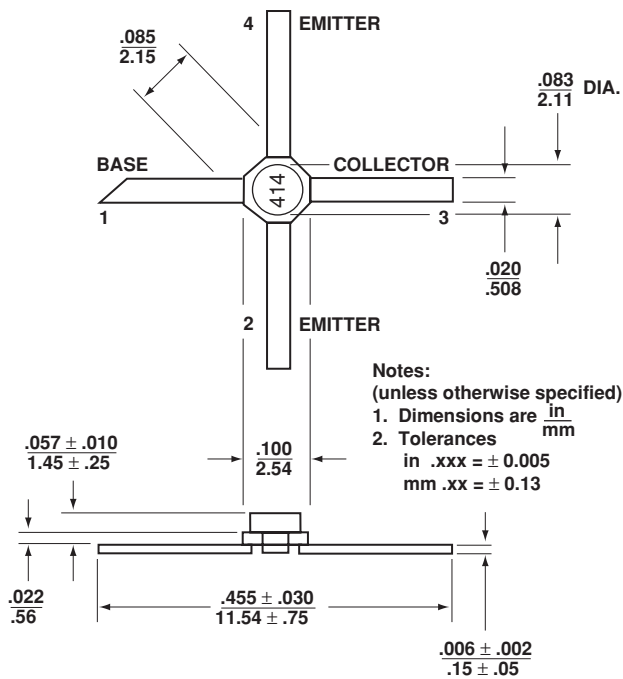

www.agilent.com/semiconductors

For product information and a complete list of distributors, please go to our web site.

For technical assistance call:

Americas/Canada: +1 (800) 235-0312 or
(916) 788-6763

Europe: +49 (0) 6441 92460

China: 10800 650 0017

Hong Kong: (65) 6756 2394

India, Australia, New Zealand: (65) 6755 1939

Japan: (+81 3) 3335-8152(Domestic/International), or
0120-61-1280(Domestic Only)

Korea: (65) 6755 1989

Singapore, Malaysia, Vietnam, Thailand, Philippines,
Indonesia: (65) 6755 2044

Taiwan: (65) 6755 1843

Data subject to change.

Copyright © 2005 Agilent Technologies, Inc.

Obsoletes 5988-9279EN

March 28, 2005

5989-2647EN



Agilent Technologies

Looking for pricing, stock, or lifecycle information?

Click below to explore more details on WIN SOURCE:

 [View AT-41435G on WIN SOURCE](#)

 [Broadcom Limited](#) Information

Optimize Your Supply Chain with WIN SOURCE Solutions

-  Global Sourcing Solution
-  Obsolete Management
-  Cost Control Management
-  Shortage Management
-  Alternative Solution
-  Excess Inventory Management