



**THE DATASHEET OF
SF1189B-1**



SF1189B-1

**280.00 MHz
SAW Filter**

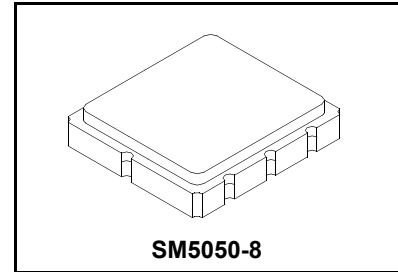

- **Designed for WLAN IF Applications**
- **Low Insertion Loss**
- **5.0 x 5.0 x 1.7 mm Surface-mount Case**
- **Single-ended Input**
- **Single-ended or Differential Output**
- **Complies with Directive 2002/95/EC (RoHS)**
- **Moisture Sensitivity Level: 1**

Absolute Maximum Ratings

Rating	Value	Units
Maximum Incident Power in Passband	+10	dBm
Maximum DC Voltage on any Non-ground Terminal	0	VDC
Storage Temperature Range	-40 to +85	°C
Suitable for Lead-free Soldering - Maximum Soldering Profile	260°C for 30 s	

Electrical Characteristics

Characteristic	Sym	Notes	Min	Typ	Max	Units
Nominal Center Frequency	f_c		280.0			MHz
Passband	Insertion Loss at fc	IL		8.3	10	dB
		3 dB Bandwidth	BW_3	18.5	19.8	MHz
	Amplitude Ripple, fc \pm 9.0 MHz			2.0	3.0	dB _{P-P}
	Group Delay Variation, fc \pm 9.0	GDV		60	125	ns _{P-P}
Rejection	fc -60 to fc -40 MHz		40	46		dB
	fc -40 to fc -22 MHz		37	39		
	fc -22 to fc -16 MHz		30	39		
	fc +16 to fc +22 MHz		25	33		
	fc +22 to fc +40 MHz		34	36		
	fc +40 to fc +60 MHz		40	45		
Operating Temperature Range	T_A		-10		+85	°C

Differential Input / Output Impedance Match	External L-C
Case Style	SM5050-8 5 X 5 mm Nominal Footprint
Lid Symbolization (Y=year, WW=week, S=shift)	457, <u>YWWS</u>

Electrical Connections

Connection	Terminals
Port 1	Single-ended Input 3
Port 2	Single-ended Output 7
	Differential Output 6,7
	Ground All others

 **CAUTION: Electrostatic Sensitive Device. Observe precautions for handling.**

NOTES:

1. The design, manufacturing process, and specifications of this device are subject to change.
2. US or International patents may apply.
3. RoHS compliant from the first date of manufacture.

Amplitude Response

Note: Insertion loss of balun transformer -0.7 dB

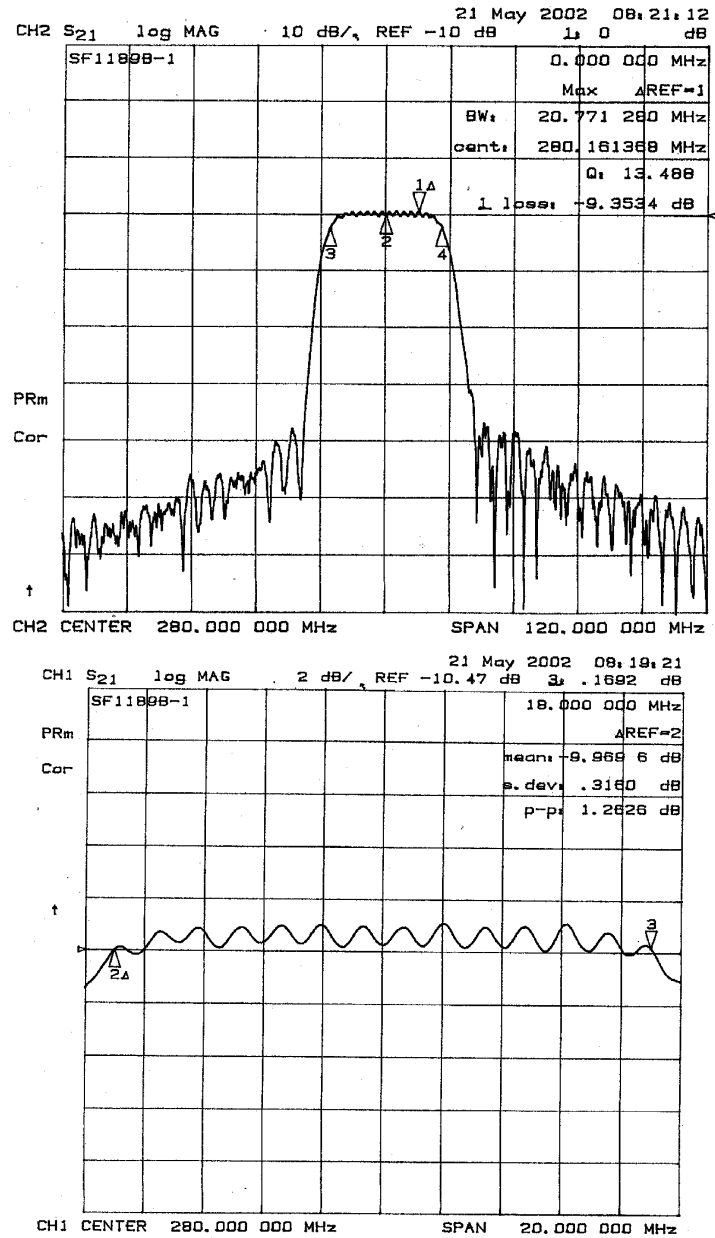
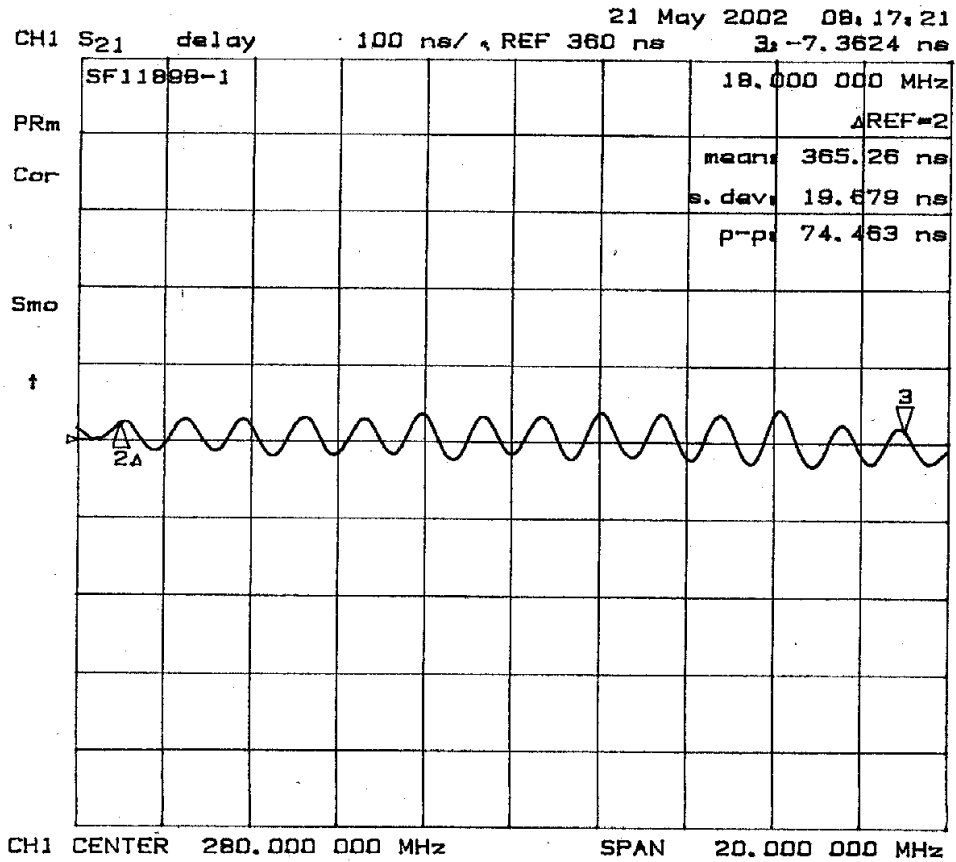
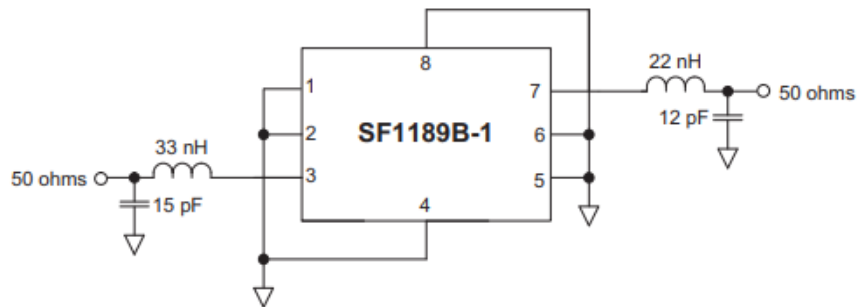

Fig-1 S₂₁ Response

Group Delay Response



Matching for Single-ended Input and Output



Matching for Single-ended Input, Balanced Output

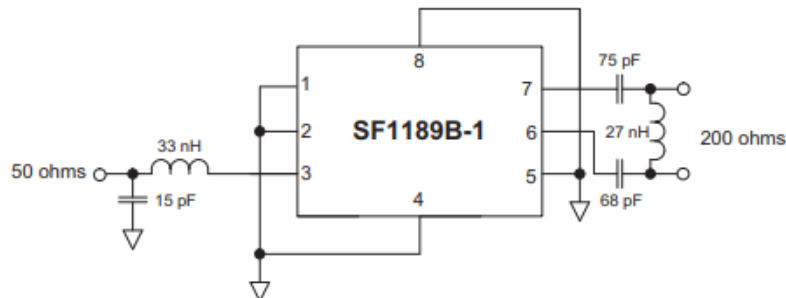

SM5050-8 Ceramic Surface-mount Case 5.0 X 5.0 mm Nominal Footprint

Case Dimensions

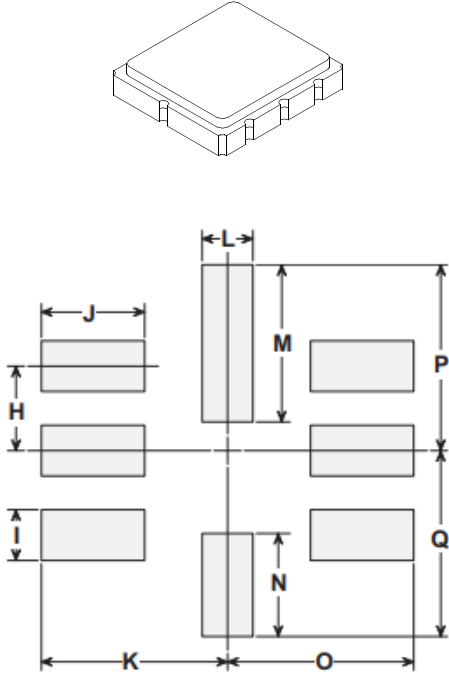

Typical PCB Land

Dimension	mm			Inches		
	Min	Nom	Max	Min	Nom	Max
A	4.80	5.00	5.20	0.189	0.197	0.205
B	4.80	5.00	5.20	0.189	0.197	0.205
C	1.30	1.50	1.70	0.050	0.060	0.067
D	1.98	2.08	2.18	0.078	0.082	0.086
E	1.07	1.17	1.27	0.042	0.046	0.050
F	0.50	0.64	0.70	0.020	0.025	0.028
G	2.39	2.54	2.69	0.094	0.100	0.106
H		1.27			0.050	
I		0.76			0.030	
J		1.55			0.061	
K		2.79			0.110	
L		0.76			0.030	
M		2.36			0.093	
N		1.55			0.061	
O		2.79			0.110	
P		2.79			0.110	
Q		2.79			0.110	

Case Materials

Materials	
Solder Pad Plating	0.3 to 1.0 μm Gold over 1.27 to 8.89 μm Nickel
Lid Plating	2.0 to 3.0 μm Nickel
Body	Al_2O_3 Ceramic

TOP VIEW

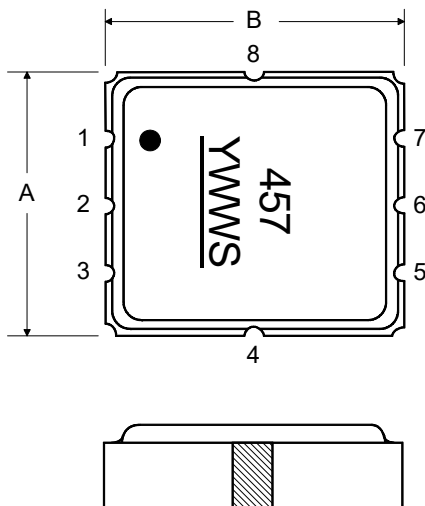

BOTTOM VIEW

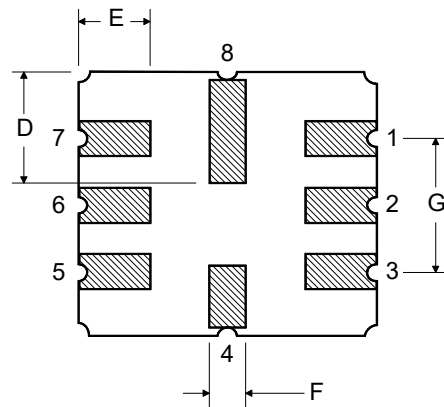

Tape and Reel Specifications

Tape and Reel Standard per ANSI/EIA-481

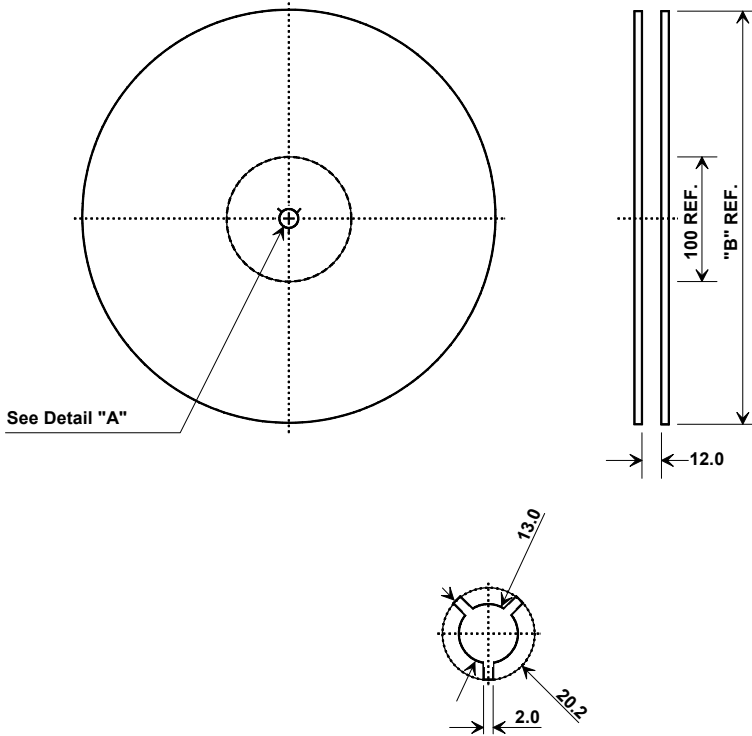

"B" Nominal Size		Quantity Per Reel
Inches	millimeters	
7	178	500
13	330	3000

COMPONENT ORIENTATION and DIMENSIONS

Carrier Tape Dimensions	
Ao	5.3 mm
Bo	5.3 mm
Ko	2.0 mm
Pitch	8.0 mm
W	12.0 mm

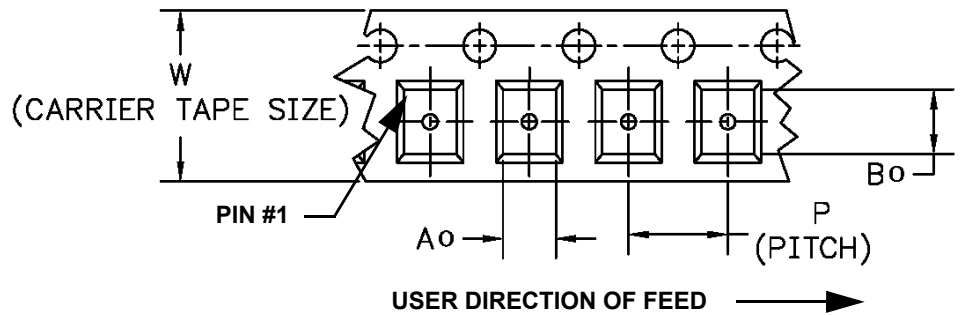
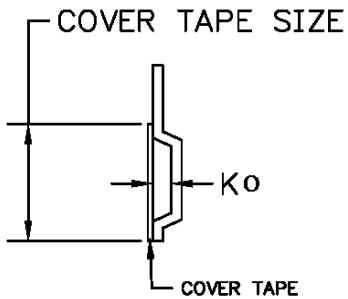

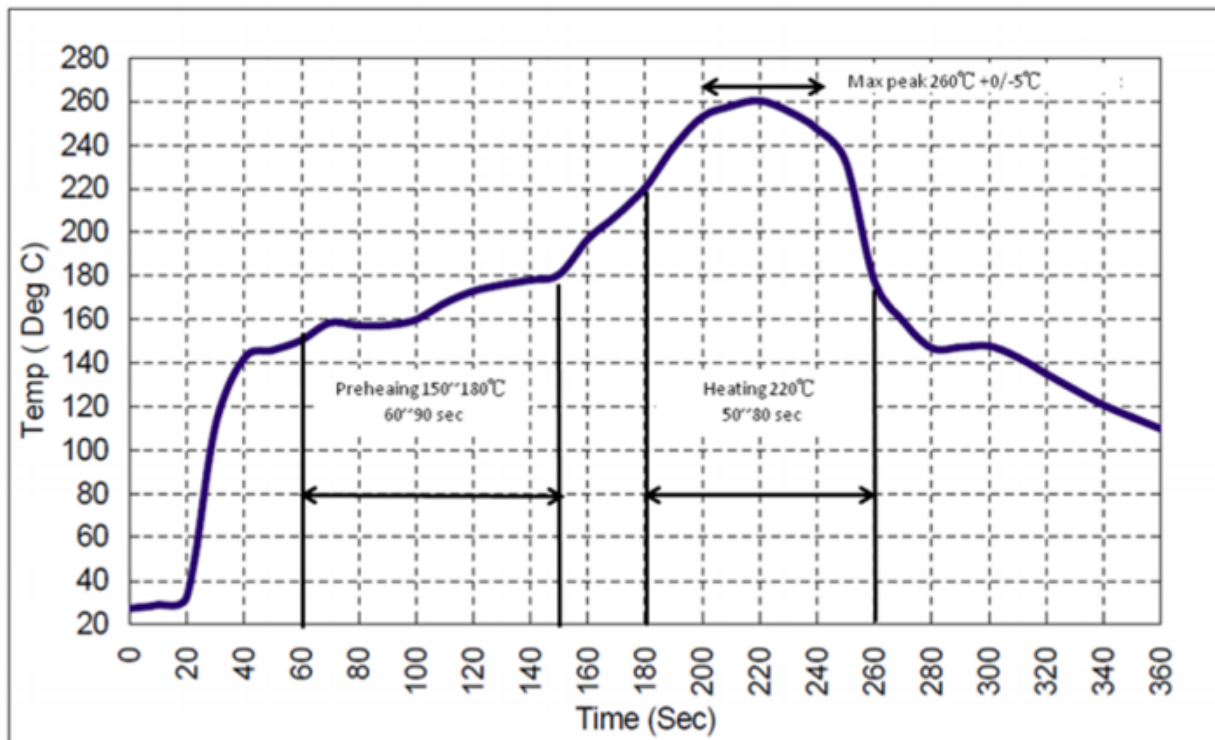

Recommended Reflow Profile

1. Preheating shall be fixed at 150~180°C for 60~90 seconds.
2. Ascending time to preheating temperature 150°C shall be 30 seconds min.
3. Heating shall be fixed at 220°C for 50~80 seconds and at 260°C+0/-5°C peak (10 seconds).
4. Time: 5 times maximum.



Looking for pricing, stock, or lifecycle information?

Click below to explore more details on WIN SOURCE:

-  [View SF1189B-1 on WIN SOURCE](#)
-  [RF Monolithics, Inc Information](#)

Optimize Your Supply Chain with WIN SOURCE Solutions

-  Global Sourcing Solution
-  Obsolete Management
-  Cost Control Management
-  Shortage Management
-  Alternative Solution
-  Excess Inventory Management