

T1/Cept/ISDN-PRI Transformers

Dual Surface Mount, 1500 Vrms, Extended & Standard Temperature Range



- RoHS peak reflow temperature rating: 245°C
- Dual SMT package contains transmit and receive transformers
- Models matched to leading transceiver ICs
- Isolation voltage: 1500 Vrms
- UL recognized

Electrical Specifications @ 25°C

RoHS-6 Compliant Part Number	Turns Ratio ^B (Pri:Sec ±2%)	OCL @ 25°C (mH MIN)	L _L (μH MAX)	C _{w/w} (pF MAX)	DCR Pri (Ω MAX)	DCR Sec (Ω MAX)	Package/Schematic	Primary Pin
Extended Temperature Range Models¹ - Operating Temperature -40°C to +85°C								
PE-68841NL	1CT:2CT & 1CT:2CT	1.20 & 1.20	0.80 & 0.80	50 & 50	1.00 & 1.00	1.70 & 1.70	AN/2	12-10, 4-6
PE-68822NL	1CT:2CT & 1:1.36CT	1.60 & 1.60	1.00 & 0.80	60 & 55	1.70 & 1.70	2.00 & 1.70	AN/1	12-10, 4-6
PE-68826NL ^E	1:1/1.26 & 1:2CT	1.20 & 1.20	0.80 & 0.80	50 & 60	1.00 & 1.00	1.10 & 1.70	AN/4	12-10, 4-6
PE-68828NL	1CT:1CT & 1CT:1CT	1.20 & 1.20	0.80 & 0.80	50 & 50	1.00 & 1.00	1.00 & 1.00	AN/2	1-3, 4-6
PE-68874NL	1CT:1.15CT & 1CT:1.15CT	1.20 & 1.20	0.80 & 0.80	50 & 50	1.20 & 1.20	1.40 & 1.40	AN/2	1-3, 4-6
PE-68877NL	1CT:1CT & 1CT:2CT	1.20 & 1.20	0.80 & 0.80	50 & 50	1.00 & 1.00	1.00 & 1.80	AN/2	1-3, 4-6
PE-68884NL	1CT:1.36CT & 1CT:1.36CT	1.20 & 1.20	0.80 & 0.80	50 & 50	1.20 & 1.20	1.40 & 1.40	AN/2	1-3, 4-6
Standard Temperature Range Models - Operating Temperature 0°C to +70°C								
PE-68864NL ^A	1CT:2CT & 1:1	1.20 & 1.20	0.30-0.55 & 0.80	30 & 30	0.70 & 0.70	1.20 & 0.70	AN/3	1-3, 5-6
PE-68836NL ^E	1:1/1.26 & 1:1/1.26	1.50 & 1.50	0.40 & 0.40	45 & 35	0.80 & 0.80	1.00 & 1.00	AN/5	12-10, 9-7

Notes: To order Tape & Reel packaging, add a "T" suffix to the part number (i.e. PE-68864NL becomes PE-68864NLT).

See Page 7 and 8 for Table Notes.

Mechanical

Schematics

AN

Dimensions: $\frac{\text{Inches}}{\text{mm}}$ Unless otherwise specified, all tolerances are $\pm \frac{.010}{0,25}$

SUGGESTED PAD LAYOUT

Weight4.0 grams
Tape & Reel250/reel
Tube30/tube

T1/Cept/ISDN-PRI Transformers

Dual Surface Mount, 1500 Vrms, Small Package

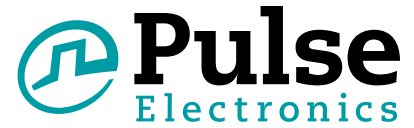

- RoHS peak reflow temperature rating: 245°C
- Dual SMT package contains transmit and receive transformers
- Models matched to leading transceiver ICs
- UL recognized (some parts pending approval)

Electrical Specifications @ 25°C

RoHS-6 Compliant Part Number		Turns Ratio ^B (Pri:Sec ±5%)	OCL (mH MIN)	C _{w/w} (pF MAX)	L _L (μH MAX)	DCR Pri (Ω MAX)	Package/ Schematic	Primary Pins
STD Temp	EXT Temp							
PE-65861NL	T1090NL	1CT:2CT & 1CT:2CT	1.20 & 1.20	30 & 30	.60 & .60	0.70 & 0.70	BH/1	16-14, 6-8
-	T1076NL	1:1.15CT & 1CT:2CT	1.20 & 1.20	30 & 30	.60 & .60	0.70 & 0.70	BH/2	16-14, 6-8
PE-65870NL	-	1CT:1.15CT & 1CT:1.15CT	1.20 & 1.20	30 & 30	.60 & .60	0.70 & 0.70	BH/1	1-3, 6-8
PE-68678NL	T1094NL	1CT:1CT & 1CT:2CT	1.20 & 1.20	30 & 30	.60 & .60	0.70 & 0.70	BH/1	16-14, 6-8
PE-68786NL	-	1CT:1.4CT & 1CT:1.4ICT	1.00 & 1.00	30 & 30	.60 & .60	0.70 & 0.70	BH/1	16-14, 11-9
T1023NL	-	1CT:1.4CT & 1CT:1.4ICT	1.00 & 1.00	30 & 30	.60 & .60	0.70 & 0.70	BH/1	1-3, 11-9
T1021NL	-	2CT:1/1.26CT & 2CT:1/1.26	1.50 & 1.50	40 & 40	.50 & .50	0.70 & 0.70	BH/1	1-3, 11-9
T1137NL	TX1287NL	1CT:2.42CT & 1CT:2.42CT	1.20 & 1.20	25 & 25	.60 & .60	0.70 & 0.70	BH/1	1-3, 6-8
-	T1146NL	1:2/2.4 & 1CT:2CT	1.00 & 1.00	35 & 35	1.00 & 1.00	0.80 & 0.80	BH/4	1-3, 6-8
-	TX1188NL	1CT:2CT & 1CT:2CT	1.20 & 1.20	30 & 30	.60 & .60	0.70 & 0.70	BH/1	1-3, 6-8
-	TX1089NL	1CT:1CT & 1CT:1CT	1.20 & 1.20	30 & 30	.80 & .80	0.70 & 0.70	BH/1	1-3, 6-8
-	TX1467NL	1CT:1CT & 1CT:2CT	1.20 & 1.20	30 & 30	.80 & .80	1.00 & 1.00	BH/3	16-14, 11-9

Notes: Standard (STD) operating temperature range is 0C to 70C. Extended (EXT) operating temperature range is -40C to +85C.

See pages 7 and 8 for table notes.

Mechanicals

Schematics

BH



Weight1.0 grams
Tape & Reel600/reel
Tube40/tube

USA 858 674 8100

Germany 49 7032 7806 0

Singapore 65 6287 8998

Shanghai 86 21 62787060

China 86 755 33966678

Taiwan 886 3 4356768

T1/Cept/ISDN-PRI Transformers

Single Reinforced Insulation, 3 kVrms



- RoHS peak reflow temperature rating: 245°C
- Dual SMT package contains transmit and receive transformers
- Models matched to leading transceiver ICs
- Isolation voltage: 1500 Vrms
- UL recognized

Electrical Specifications @ 25°C - Operating Temperature 0°C to 70°C (Unless Otherwise Noted)

RoHS-6 Compliant Part Number	Turns Ratio ^B (Pri:Sec ±5%)	^B OCL ^C (mH MIN)	w/w ^L (pF MAX)	L (μH MAX)	DCR Pri (Ω MAX)	DCR Sec (Ω MAX)	Package/ Schematic	Primary Pins
PE-65830NL	1.27CS:1	.800	15	0.70	0.50	0.35	IS/3	1-5
PE-65832NL	1:1.36CT	1.20	35	0.60	0.70	0.90	IS/4	10-6
PE-65833NL ^A	1CT:2CT	1.20	20	0.30-0.55	0.50	0.90	IS/1	1-5
PE-65834NL	1:1	1.20	20	0.50	0.50	0.50	IS/2	1-5
PE-65835NL	1CT:2CT	1.20	15	0.80	0.70	1.10	IS/1	1-5
PE-65838NL	1:1.14CT	1.50	30	1.00	0.70	0.90	IS/4	10-6
PE-65839NL ^E	1:1/1.26	1.50	35	0.60	0.70	1.10	IS/4	10-6
PE-68646NL ^E	1:1.58/2	1.50	20	0.70	0.70	1.20	IS/4	10-6

or table notes.

Mechanical

Schematics

IS

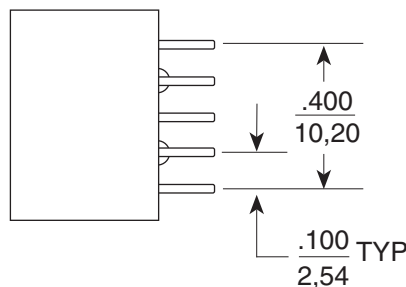
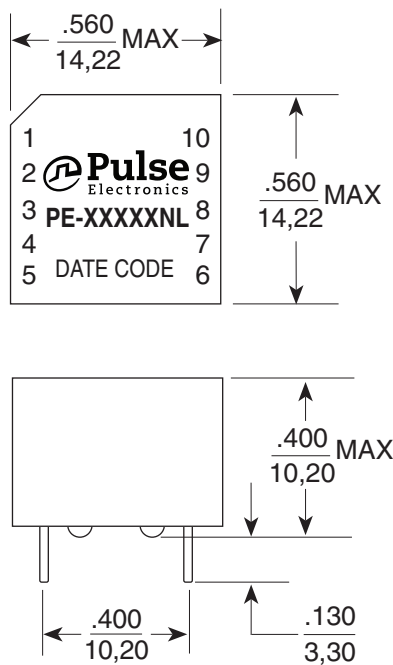

Notes:
 Leads are 22 AWG solderable.
 Unused pins not provided.

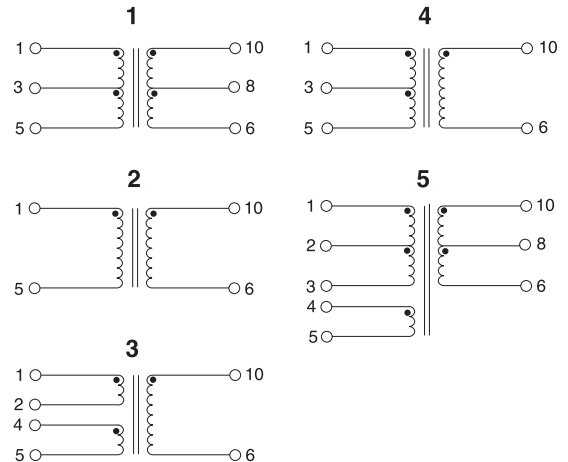

Dimensions: Inches/mm Unless otherwise specified, all tolerances are ± .010/0,25

Weight4 grams
Tube35/tube

USA 858 674 8100

Germany 49 7032 7806 0

Singapore 65 6287 8998

Shanghai 86 21 62787060

China 86 755 33966678

Taiwan 886 3 4356768

T1/Cept/ISDN-PRI Transformers

Single Through Hole, 1500Vrms



- RoHS peak reflow temperature rating: 245°C
- Extended and standard temperature range
- Dual and single through hole models available
- Models matched to leading transceiver ICs
- UL recognized
- Isolation Voltage: 1500 Vrms MIN

Electrical Specifications @ 25°C

RoHS-6 Compliant Part Number	Turns Ratio ^B (Pri:Sec ±2%)	OCL @ 25°C (mH MIN)	C _{w/w} (pF MAX)	L _L (μH MAX)	DCR Pri (Ω MAX)	DCR Sec (Ω MAX)	Package/Schematic	Primary Pins
Standard Temperature Range Single Transformers - Operating Temperature 0°C to +70°C								
PE-64931NL	1:1:1 (1:2CS)	1.20	25	0.50	0.70	0.70 & 0.70	HC/2	1-2
PE-64934NL	1:1:w	1.20	25	0.50	0.70	0.70	HC/1	1-2
PE-64936NL ^E	1CT:1	1.20	25	0.80	0.70	0.70	HC/3	1-5
PE-64937NL	1:1.36	1.20	35	0.80	0.70	0.80	HC/1	5-6
PE-65351NL	1:2CT	1.20		0.50	0.70	1.30	HC/3	2-6
PE-65363NL	1:4CT	0.50	40	1.00	0.70	1.50	HC/5	1-5
PE-65388NL	1:1.15CT	1.50	35	0.60	0.70	0.90	HC/3	2-6
PE-65389NL ^E	1:1/1.26	1.50	40	0.40	0.70	0.90	HC/3	2-6
PE-65415NL	1CT:2CT	1.20	30	0.50	0.70	1.20	HC/4	1-5
PE-68644NL	1CT:1	0.70	20	0.70	0.20	0.80	HC/3	1-5
Extended Temperature Range Single Transformer - Operating Temperature -40°C to +85°C								
PE-65770NL	1:1.15CT	1.50	40	0.80	0.90	1.00	HC/3	2-6
PE-65771NL	1CT:2CT	1.20	50	0.60	1.00	2.00	HC/4	2-6
PE-65778NL	1CT:1CT	1.20	40	1.00	1.00	1.00	HC/4	1-5
TX1252NL	1CT:1	1.20	40	1.00	1.00	1.00	HC/3	1-5

ages 7 and 8 for Table Notes.

Mechanical

Schematic

HC

Notes: Leads are 24 AWG solderable. Unused pins not provided.

Dimensions: $\frac{\text{Inches}}{\text{mm}}$ Unless otherwise specified, all tolerances are $\pm \frac{.010}{0,25}$

Weight2 grams
 Tube60/tube

USA 858 674 8100

Germany 49 7032 7806 0

Singapore 65 6287 8998

Shanghai 86 21 62787060

China 86 755 33966678

Taiwan 886 3 4756768

T1/Cept/ISDN-PRI Transformers

Dual Through Hole, 1500 Vrms



Electrical Specifications @ 25°C

RoHS-6 Compliant Part Number	Turns Ratio ^B (Pri:Sec ±5%)	OCL @ 25°C (mH MIN)	C _{w/w} (pF MAX)	L _L (μH MAX)	DCR Pri (Ω MAX)	DCR Sec (Ω MAX)	Package/Schematic	Primary Pins
Standard Temperature Range Single Transformers - Operating Temperature 0°C to +70°C								
PE-64952NL	1:2CT & 1:1.36	1.20 & 1.20	35 & 35	0.50 & 0.80	0.80 & 0.80	1.20 & 1.00	HD/2	14-12, 5-7
PE-65565NL	1:1.15CT & 1:2CT	1.50 & 1.20	35 & 40	0.60 & 0.50	0.70 & 0.70	1.10 & 1.30	TD/1	14-12, 5-7

See Pages 7 and 8 for Table Notes.

Mechanics

TD DUAL



Weight2.6 grams
 Tube25/tube

Dimensions: $\frac{\text{Inches}}{\text{mm}}$
 Unless otherwise specified, all tolerances are $\pm \frac{.010}{0,25}$

HD DUAL

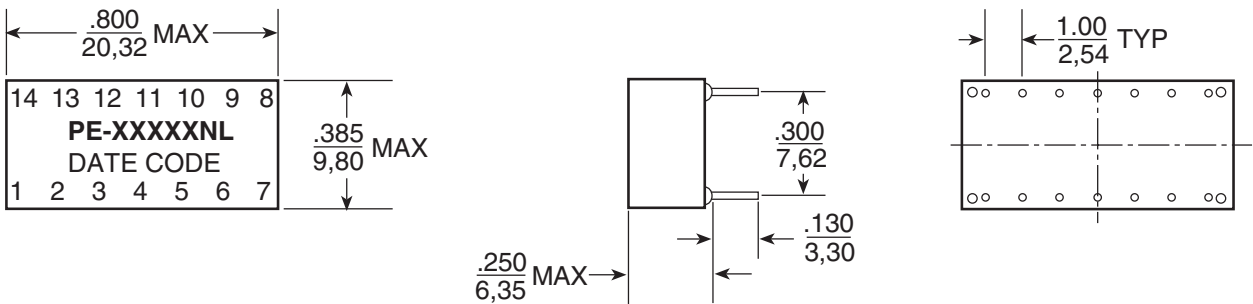

Weight2.3 grams
 Tube25/tube

Dimensions: $\frac{\text{Inches}}{\text{mm}}$
 Unless otherwise specified, all tolerances are $\pm \frac{.010}{0,25}$

Schematics

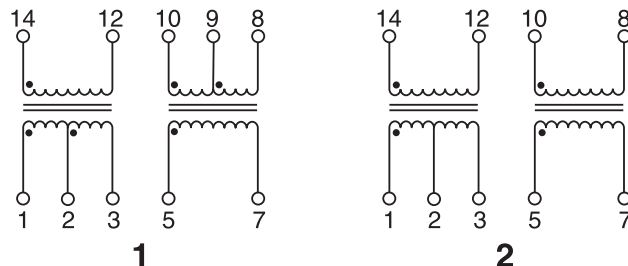

T1/Cept/ISDN-PRI Transformers

Transformer Selection Guide

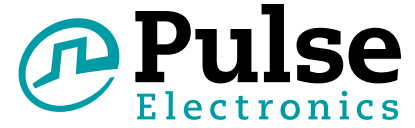

IC Manufacturer/ IC Part Number	Com_ments	Dual SMT (BH Pkg.)		Dual SMT (AN Pkg.)		Single Through Hole				Dual Through Hole		Single Through Hole			
		Std Temp	Ext Temp	Std Temp	Ext Temp	Standard Temp		Extended Temp		Std Temp	Ext Temp	Reinforced 3 k Vrms			
		TX & RX	TX & RX	TX & RX	TX & RX	TX	RX	TX	RX	TX & RX	TX & RX	TX	RX		
Mindspeed (Conexant)	BT8510	TI/EI	-	-	-	PE-68826NL	PE-65389NL	PE-65351NL	-	PE-65771NL	-	-	PE-65839NL	PE-65835NL	
	BT8510	TI/EI	-	-	T1021NL	PE-68826NL	PE-65389NL	PE-65351NL	-	PE-65771NL	-	-	PE-65839NL	PE-65835NL	
	BT8370/5/6	Better RL	-	-	-	PE-68822NL	PE-64937NL	PE-64936NL	-	PE-65771NL	PE-64952NL	-	PE-65832NL	PE-65834NL	
	BT8370/5/6	Low Power	-	T1076NL	-	-	PE-65388NL	PE-64936NL	-	PE-65771NL	PE-65565NL	-	PE-65838NL	PE-65834NL	
Cirrus Logic (Crystal)	61318	120 EI	PE-68678NL	T1094NL	PE-68877NL	PE-68877NL	PE-65351NL	PE-64936NL	PE-65771NL	PE-65778NL	-	-	PE-65835NL	PE-65835NL	
	61318	75 EI	-	-	-	-	PE-64936NL	PE-64936NL	-	PE-65778NL	-	-	PE-68646NL	PE-65835NL	
	61577	TI & EI	PE-65861NL	T1090NL	-	PE-68841NL	PE-65351NL	PE-65351NL	-	PE-65771NL	-	-	PE-65835NL	PE-65835NL	
	61304A/5A/535A/574A../75	TI	-	T1076NL	-	-	PE-65388NL	PE-65351NL	PE-65770NL	PE-65771NL	PE-65565NL	-	PE-65838NL	PE-65835NL	
	61304A/5A/535A/574A../75	75 EI	-	-	-	PE-68826NL	PE-65389NL	PE-65351NL	-	PE-65771NL	-	-	PE-65838NL	PE-65835NL	
	61304A/5A/535A/574A../75	120 EI	-	-	-	PE-68826NL	PE-65389NL	PE-65351NL	-	PE-65771NL	-	-	PE-65838NL	PE-65835NL	
	61582, 61583	-	PE-65870NL	-	PE-68874NL	PE-68874NL	PE-65388NL	PE-65388NL	PE-65770NL	PE-65770NL	PE-65770NL	-	-	PE-65838NL	PE-65838NL
	61582, 61581	-	PE-68678NL	T1094NL	PE-68877NL	PE-68877NL	PE-65351NL	PE-64936NL	PE-65771NL	PE-68778NL	PE-68778NL	-	-	PE-65835NL	PE-65835NL
	61582, 61581	Host	-	-	-	-	PE-65351NL	PE-64936NL	PE-65771NL	PE-68771NL	PE-68771NL	-	-	PE-65835NL	PE-65835NL
	61881	-	-	T1076NL	-	-	PE-65388NL	PE-65351NL	PE-65770NL	PE-68771NL	PE-68771NL	-	-	PE-65835NL	PE-65835NL
	61584/84A	IQ3	PE-65861NL	T1090NL	-	PE-68841NL	PE-65351NL	PE-65351NL	PE-65771NL	PE-68771NL	PE-68771NL	-	-	PE-65835NL	PE-65835NL
	61584/82/83/A	IQ5	PE-65870NL	-	PE-68874NL	PE-68874NL	PE-65388NL	PE-65388NL	PE-65770NL	PE-68770NL	PE-68770NL	-	-	PE-65838NL	PE-65838NL
Maxim (Dallas)	DS2196	-	PE-68678NL	T1094NL	PE-68877NL	PE-68877NL	PE-65351NL	PE-64936NL	PE-65771NL	PE-65778NL	-	-	PE-65835NL	PE-65838NL	
	DS2151/2152/2153/2154	-	-	T1076NL	-	-	PE-65388NL	PE-64936NL	PE-65770NL	PE-65778NL	PE-65565NL	-	PE-65834NL	PE-65834NL	
	DS2151/2152/2153/2154	-	-	-	-	PE-68822NL	-	PE-64936NL	-	PE-65778NL	PE-64952NL	-	PE-65832NL	PE-65834NL	
	DS2148/O48	3V	PE-68678NL	T1094NL	PE-68877NL	PE-68877NL	PE-65351NL	PE-64936NL	PE-65771NL	PE-65778NL	PE-65778NL	-	PE-65838NL	PE-65838NL	
	DS2148/O48	5V	-	-	-	PE-68822NL	-	PE-64936NL	-	PE-65778NL	PE-64952NL	-	PE-65832NL	PE-65834NL	
	DS21352/O352, DS21354/O354	-	PE-65878NL	T1094NL	PE-68874NL	PE-68877NL	PE-65351NL	PE-64936NL	PE-65771NL	PE-65778NL	-	-	PE-65838NL	PE-65838NL	
	DS21552/O552, DS21354/O554	-	-	T1076NL	-	-	PE-65388NL	PE-64936NL	PE-65770NL	PE-68778NL	PE-65565NL	-	PE-65838NL	PE-65834NL	
DS21552/Qww52, DS1554/O554	-	-	-	-	PE-68822NL	-	PE-64936NL	-	PE-68778NL	PE-64952NL	-	PE-65832NL	PE-65834NL		
Exar	T5683A, 59L91	-	PE-65861NL	T1090NL	-	PE-68841NL	PE-65415NL	PE-65415NL	PE-65771NL	PE-65771NL	-	-	PE-65835NL	PE-65835NL	
	T5894, T5897, T5997	-	PE-65861NL	T1090NL	PE-65861NL	PE-68841NL	PE-65415NL	PE-65415NL	PE-65771NL	PE-65771NL	-	-	PE-65835NL	PE-65835NL	
	T5791/T93/94/95	-	-	-	-	PE-68826NL	PE-65389NL	PE-64934NL	-	PE-65778NL	-	-	PE-65839NL	PE-65834NL	
	T5894, T5897, T5997	-	-	-	-	PE-68822NL	PE-64937NL	PE-65415NL	-	PE-65771NL	PE-64952NL	-	PE-65832NL	PE-65835NL	
	82L30/34/38	-	PE-65861NL	T1090NL	PE-65861NL	PE-68841NL	PE-65415NL	PE-65415NL	PE-65771NL	PE-65771NL	-	-	PE-65835NL	PE-65835NL	
	82L34/38	-	-	-	-	-	-	-	-	-	-	-	-	-	
	T5684, T7288, 82D20	-	-	-	-	PE-68822NL	PE-64937NL	PE-65351NL	-	PE-65771NL	PE-64952NL	-	-	PE-65835NL	PE-65835NL
	Infineon Technologies	PEB 2254/55	EI/TT & JI	PE-68786NL	-	-	-	-	-	-	-	-	-	-	-
		PEB 2254/55	EI/TT & JI	T1023NL	-	-	-	-	-	-	-	-	-	-	-
	Intel (Level One)	LXT 300/301	-	PE-65861NL	T1090NL	-	PE-68841NL	PE-65351NL	PE-65351NL	PE-65771NL	PE-65771NL	-	-	PE-65835NL	PE-65835NL
LXT 304/305/307		EI, TI	PE-65861NL	T1090NL	-	PE-68841NL	PE-65351NL	PE-65351NL	PE-65771NL	PE-65771NL	-	-	PE-65835NL	PE-65835NL	
LXT 304/305/307		TI	-	T1076NL	-	-	PE-65388NL	PE-65351NL	PE-65770NL	PE-65771NL	PE-65565NL	-	PE-65838NL	PE-65835NL	
LXT 304/305/307		75EI, 120EI	-	-	-	PE-68826NL	PE-65389NL	PE-65351NL	-	PE-65771NL	-	-	PE-65839NL	PE-65835NL	
LXT 304/305/307		DSX-1, D4	-	-	-	-	-	PE-65351NL	-	PE-65771NL	-	-	PE-65835NL	PE-65835NL	
LXT 310/317/318		-	PE-68678NL	T1094NL	-	-	PE-65351NL	PE-64936NL	PE-65771NL	PE-65778NL	-	-	PE-65835NL	PE-65834NL	
LXT 312/313/315		-	-	-	-	-	-	PE-64936NL	PE-65778NL	PE-65778NL	-	-	PE-65834NL	PE-65834NL	
LXT 331		TI, EI	PE-68678NL	T1094NL	PE-68877NL	PE-68877NL	PE-65351NL	PE-65351NL	PE-65771NL	PE-65778NL	PE-65778NL	-	-	PE-65835NL	PE-65834NL
LXT 331, LXT 332		-	PE-65861NL	T1090NL	-	PE-68841NL	PE-65351NL	PE-65351NL	PE-65771NL	PE-65771NL	-	-	PE-65835NL	PE-65835NL	
LXT 331, LXT 332		-	-	T1076NL	-	-	PE-65388NL	PE-65351NL	PE-65770NL	PE-65771NL	PE-65565NL	-	PE-65838NL	PE-65835NL	
LXT 331, LXT 332		-	-	-	-	-	-	PE-65351NL	-	PE-65771NL	-	-	PE-65838NL	PE-65835NL	
LXT 334, LXT 335		TI, EI	PE-65861NL	T1090NL	-	PE-68841NL	PE-65351NL	PE-65351NL	PE-65771NL	PE-65771NL	PE-65771NL	-	PE-65838NL	PE-65835NL	
LXT 334, LXT 335		120/75 EI	-	-	-	PE-68822NL	PE-65351NL	PE-65351NL	PE-65771NL	PE-65771NL	PE-64952NL	-	PE-65835NL	PE-65835NL	
LXT 334, LXT 335		75 EI	-	-	-	PE-68826NL	PE-65389NL	PE-65351NL	PE-65771NL	PE-65771NL	-	-	PE-65839NL	PE-65835NL	
LXT 334, LXT 335		-	-	-	-	-	PE-64936NL	-	-	-	-	-	-	-	
LXT 336		-	PE-65861NL	T1090NL	PE-68828NL	PE-68828NL	-	PE-65351NL	-	PE-65778NL	-	-	-	PE-65835NL	
LXT 350, LXT 351, LXT 359		TI, EI	PE-68678NL	T1094NL	PE-68877NL	PE-68877NL	PE-68877NL	PE-65351NL	PE-64936NL	PE-65771NL	PE-65778NL	-	-	PE-65835NL	PE-65834NL
LXT 350, LXT 351		-	-	T1076NL	-	-	-	PE-65388NL	PE-65351NL	PE-65770NL	PE-65771NL	PE-65565NL	-	PE-65838NL	PE-65835NL
LXT 350, LXT 351		120, EI	-	-	-	-	-	PE-65351NL	-	PE-65771NL	-	-	-	-	
LXT 360/361/362/363		TI, EI	PE-68678NL	T1094NL	PE-68877NL	PE-68877NL	PE-68877NL	PE-65351NL	PE-64936NL	PE-65771NL	PE-65778NL	-	-	PE-65835NL	PE-65834NL
LXT 360/361/362/363	-	-	T1076NL	-	-	-	PE-65388NL	PE-65351NL	PE-65770NL	PE-65771NL	PE-65565NL	-	PE-65838NL	PE-65835NL	
LXT 360, LXT 361	120, EI	-	-	-	-	-	PE-65351NL	-	PE-65771NL	-	-	-	-		
LXT 380/381/384/386/388	TI, EI	PE-68678NL	T1094NL	PE-68877NL	PE-68877NL	PE-68877NL	PE-65351NL	PE-64936NL	PE-65771NL	PE-65778NL	-	-	PE-65835NL	PE-65834NL	
LXT 380/381/384/386/388	TI, EI	PE-65861NL	T1090NL	-	PE-68841NL	PE-68841NL	PE-65351NL	PE-65351NL	PE-65771NL	PE-65771NL	-	-	PE-65835NL	PE-65835NL	
LXT 3104, LXT 3108	TI, EI	PE-65861NL	T1090NL	-	PE-68841NL	PE-68841NL	PE-64936NL	PE-4936NL	PE-65778NL	PE-65778NL	-	-	PE-65835NL	PE-65835NL	
Lucent Technologies	T7288, T290A	CEPT	-	-	-	PE-68822NL	-	PE-65415NL	-	PE-6571NL	PE-64952NL	-	PE-65832NL	PE-65835NL	
	T7289A	DS1	-	T1076NL	-	-	-	PE-65351NL	PE-65770NL	PE-6571NL	PE-65565NL	-	PE-65838NL	PE-65835NL	
	T7688, T7690, T7698	CEPT	-	-	PE-6884NL	PE-6884NL	-	-	-	-	-	-	PE-65832NL	PE-65832NL	
	T7689, T7690, T7698	DS1	PE-65870NL	-	PE-68874NL	PE-68874NL	-	-	PE-65770NL	PE-65770NL	-	-	PE-65838NL	PE-65838NL	
	T7693, T7697	CEPT	-	-	-	-	-	-	-	-	-	-	-	-	
	TLIU04C1	DS1	PE-65870NL	-	PE-68874NL	PE-68874NL	-	-	PE-65770NL	PE-65770NL	-	-	PE-65838NL	PE-65838NL	
TLIU04C1	CEPT	-	-	PE-6884NL	PE-6884NL	-	-	-	-	-	-	PE-65832NL	PE-65832NL		
Zarlink	MT9071, MT9076	-	T1137NL	TX1287NL	-	-	-	-	-	-	-	-	-	-	
	MT9074, MT9075	-	PE-68678NL	T1094NL	PE-68877NL	PE-68877NL	PE-65351NL	PE-64934NL	PE-65771NL	PE-65778NL	-	-	PE-65835NL	PE-65834NL	
PMC-Sierra	PM4318	-	-	-	-	PE-68822NL	PE-649376NL	PE-65351NL	-	PE-65771NL	PE-64952NL	-	PE-65832NL	PE-65835NL	
	PM4351/4354	COMET	PE-65861NL	T1090NL	-	PE-68841NL	PE-65351NL	PE-65351NL	PE-65771NL	PE-65771NL	-	-	PE-65835NL	PE-65835NL	

Application Notes

1. Extended Temperature Range Models - For extended temperature range transformers (-40°C to +85°C operating temperature range), OCL (Open Circuit Inductance for the primary winding) is specified at both -40°C and +25°C. At -40°C, OCL is 600 μ H minimum for all low temperature models. All other parameters are specified at +25°C only. Standard temperature range is 0°C to +70°C.

2. ET Product - All coils have an ET product of 10 V- μ sec minimum.

3. Flammability - Materials used in the products are recognized as UL94-VO approved. Products meet the requirements of IEC 695-2-2 (Needle Flame Test).

4. Balance Characteristics - The transformers meet the requirements for longitudinal balance of FCC part 68.

5. Common Mode Rejection Ratio - The CMRR for all transformers is better than 50 dB at 1 MHz. A typical test circuit is shown below.

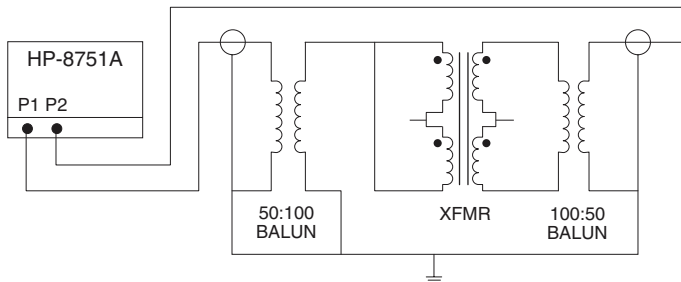

6. Crosstalk Attenuation - In the dual packages, which contain transmit and receive transformers side by side, sufficient crosstalk attenuation is achieved by the inherent characteristics of the toroid cores as well as by their proper positioning. The crosstalk attenuation is typically 50 dB or better from 100 kHz to 10 MHz. This result was established with the test circuit shown below.

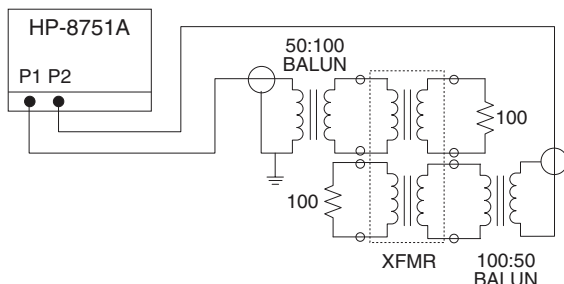

7. Return Loss - ITU-T G.703 and European national regulatory documents specify minimum return loss levels. The transformers will allow these limits to be complied within situations where they are applicable.

Frequency	50-100 kHz	100 kHz-2 MHz	2-3 MHz
Return Loss			
TX	9 dB	15 dB	11 dB
RX	12 dB	18 dB	14 dB

8. Surge Voltage Capability - All transformers and chokes meet surge voltage tests according to the most stringent regulatory documents when system designs include the proper voltage and current suppression devices:

Metallic Voltage: 800 V peak, 10/560 μ sec
 Longitudinal Voltage: 2,400 V peak, 10/700 μ sec

9. Isolation Voltage - 100% of transformers are tested during production to the specified isolation voltage level.

10. Safety Agency Recognition - Parts listed as "Recognized" or "Certified" meet Underwriter Laboratories, UL 1459 and UL 1950 per file E133523 (S).

Transformers with Reinforced Insulation according to IEC950, such as PE-68646NL (pg. 3) is certified by the following organizations:

Code	Certificate Information
T	TUV, EN60 950/EN 41003, Cert. R9371358, reinforced insulation
U	UL 1459/UL1950, File E133523 (S), reinforced insulation

11. General Information - The transformers are specifically designed for use in 1.544 Mbps (T1), 2.048 Mbps (CEPT) and ISDN Primary rate (PRI) interface applications. They are matched to the majority of the line interface transceiver ICs currently available. Use of the proper transformer allows the interface circuit to comply with ITU-T G.703 and other standards regarding pulse waveform, return loss, and balance.

12. Common Mode Chokes - The "high-frequency" 4-lines common mode chokes shown in this data sheet provide an effective means of compliance with national and international regulations on EMI. They are designed to be used in conjunction with Pulse's T1/CEPT transformers as shown in the typical application below. Crosstalk is typically -70 dB at 1 MHz and -55 dB at 10 MHz.

Typical Application

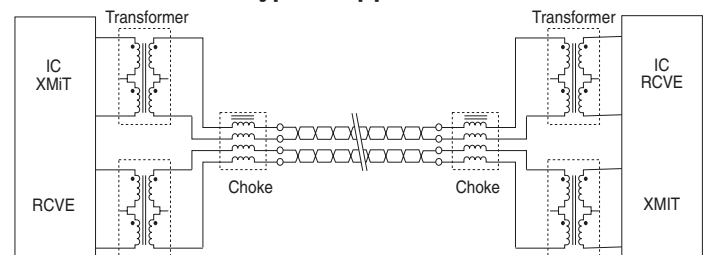

Notes From Tables (pages 1-6):

- A.** Tolerance leakage inductance: .30 μ H min to .55 μ H MAX.
- B.** OCL (primary inductance) and L_L (leakage inductance) are measured at the primary winding. Turns ratio is specified primary: secondary. (CT = Center Tap; CS = Split Center Tap).
- C.** To make a 1CT:1 ratio from a 1CT: 2CT ratio, use only one half of the secondary (2CT) winding.
- D.** For Reinforced 3 kVrms Dual SMT Transformers, refer to data sheet T617. For Octal SMT Transformers, refer to data sheet T622.
- E.** Dual Ratio Transformers: These transformers have tapped secondary windings to provide two turns ratios (T/R). Use the entire primary winding and connect

Part Number	Turns Ratio 1	Secondary Pins	Turns Ratio 2	Secondary Pins
PE-65839NL	1:1	3-5	1:1.26	1-5
PE-68646NL	1:1.58	3-5	1:2	1-5
PE-65389NL	1:1	3-5	1:1.26	1-5
PE-68826NL	1:1	2-3	1:1.26	1-3
PE-68836NL	1:1	2-3/5-6	1:1.26	1 ^{3/4} -6

- F.** Standard packaging for surface mount "AN" and "LA" packages is ant-static tubes. Optional Tape & Reel packaging can be ordered by adding "T" suffix to the part number (i.e. PE-68864NLT).
- G.** Safety Agency approvals pending.
- H.** The turns ratio of these devices have been designed, in conjunction with semiconductor vendor recommendations, to allow connections to various terminations (e.g 75 Ω or 120 Ω with the same transformer). For 75 Ω termination, the PEB 2235 requires the following turns ratio: 1:1.57 (TX) and 1:1.26 (RX) which can be achieved using pins (1-2):(15-16) for TX and (10-11):(5-8) for RX. For 120 Ω , the following turns ratio are required: 1:2 (TX) and 1:1 (RX), which are pins (1-2):(16-14) for TX and (9-11):(5-8) for RX.

Electrical Specifications @ 25°C - Operating Temperature 0°C to 70°C

Pulse Part Number	Turns Ratio ($\pm 5\%$)	OCL (μ H MIN)	Package/Schematic
HIGH FREQUENCY COMMON MODE CHOKES, 4-LINES			
PE-65554NL	1:1:1:1	24.0	IN/1 (ThroughHole)
PE-65555NL	1:1:1:1	8.0	IN/1 (ThroughHole)
PE-65854NL	1:1:1:1	47.0	SH/1 (Surface Mount)
PE-65857NL	1:1:1:1	24.0	LA/2 (Surface Mount)

Notes: For additional Common Mode Chokes, refer to data sheet **G00Z**

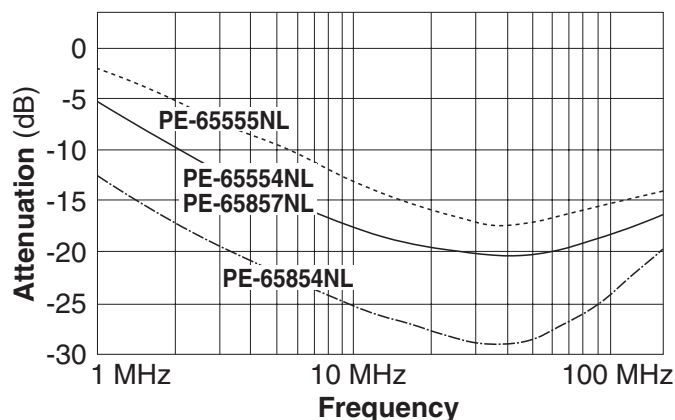

Typical common mode attenuation for high-frequency common mode chokes based on a 100 Ω system.

Schematics

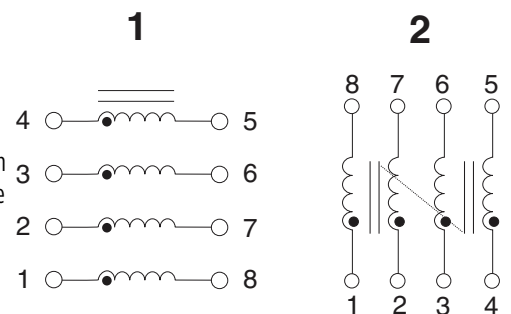

Common Mode Chokes For Telecom Applications

For EMI Reduction

Mechanicals

SH

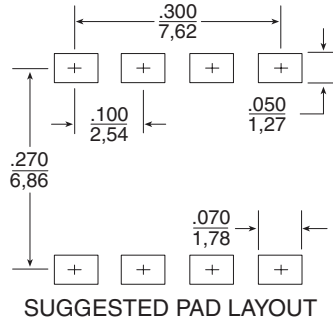
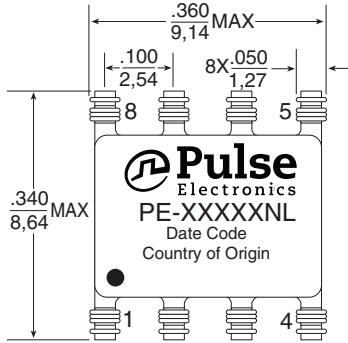

LA

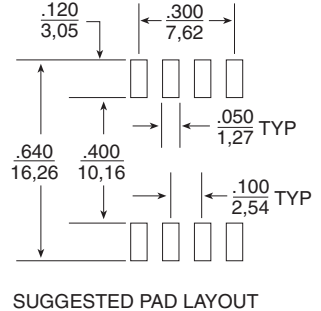

IN



	SH	LA	IN
Weight	0.3 grams	2 grams	2.5 grams
Tape & Reel	1500/reel	250/reel	(N/A)
Tube	25/tube	30/tube	35/tube
Dimensions:	Inches / mm		
Unless otherwise specified, all tolerances are ± .010 / 0.25			

For More Information

Pulse Worldwide Headquarters
12220 World Trade Drive
San Diego, CA
92128
U.S.A.

Pulse Europe
Einsteinstrasse 1
D-71083 Herrenberg
Germany
Tel: 49 7032 78060
Fax: 49 7032 7806 135

Pulse China Headquarters
B402, Shenzhen Academy of
Aerospace Technol-
ogy Bldg.
10th Kejinan Road
High-Tech Zone
Nanshan District
Shenzhen, PR China
518057
Tel: 86 755 3396678
Fax: 86 755 33966700

Pulse North China
Room 2704/2705
Super Ocean Finance
Ctr.
2067 Yan An Road
West
Shanghai 200336
China
Tel: 86 21 62787060
Fax: 86 2162786973

Pulse South Asia
135 Joo Seng Road
#03-02
PM Industrial Bldg.
Singapore 368363
Tel: 65 6287 8998
Fax: 65 6287 8998

Pulse North Asia
3F, No. 198
Zhongyuan Road
Zhongli City
Taoyuan County 320
Taiwan R. O. C.
Tel: 886 3 4356768
Fax: 886 3 4356823 (Pulse)
Fax: 886 3 4356820 (FRE)

Performance warranty of products offered on this data sheet is limited to the parameters specified. Data is subject to change without notice. Other brand and product names mentioned herein may be trademarks or registered trademarks of their respective owners. © Copyright, 2016. Pulse Electronics, Inc. All rights reserved.

Looking for pricing, stock, or lifecycle information?

Click below to explore more details on WIN SOURCE:

 [View PE-65778 on WIN SOURCE](#)

 [Pulse Information](#)

Optimize Your Supply Chain with WIN SOURCE Solutions

-  Global Sourcing Solution
-  Obsolete Management
-  Cost Control Management
-  Shortage Management
-  Alternative Solution
-  Excess Inventory Management